



wwPDB EM Validation Summary Report ⓘ

Jan 30, 2023 – 01:12 pm GMT

PDB ID : 7QY7
EMDB ID : EMD-14209
Title : Proteasome-ZFAND5 Complex Z-A state
Authors : Zhu, Y.; Lu, Y.
Deposited on : 2022-01-27
Resolution : 4.70 Å(reported)

This is a wwPDB EM Validation Summary Report for a publicly released PDB entry.

We welcome your comments at validation@mail.wwpdb.org

A user guide is available at

<https://www.wwpdb.org/validation/2017/EMValidationReportHelp>

with specific help available everywhere you see the ⓘ symbol.

The types of validation reports are described at

<http://www.wwpdb.org/validation/2017/FAQs#types>.

The following versions of software and data (see [references ⓘ](#)) were used in the production of this report:

EMDB validation analysis : 0.0.1.dev43
Mogul : 1.8.4, CSD as541be (2020)
MolProbity : 4.02b-467
buster-report : 1.1.7 (2018)
Percentile statistics : 20191225.v01 (using entries in the PDB archive December 25th 2019)
MapQ : 1.9.9
Ideal geometry (proteins) : Engh & Huber (2001)
Ideal geometry (DNA, RNA) : Parkinson et al. (1996)
Validation Pipeline (wwPDB-VP) : 2.31.3

1 Overall quality at a glance

The following experimental techniques were used to determine the structure:
ELECTRON MICROSCOPY

The reported resolution of this entry is 4.70 Å.

Percentile scores (ranging between 0-100) for global validation metrics of the entry are shown in the following graphic. The table shows the number of entries on which the scores are based.

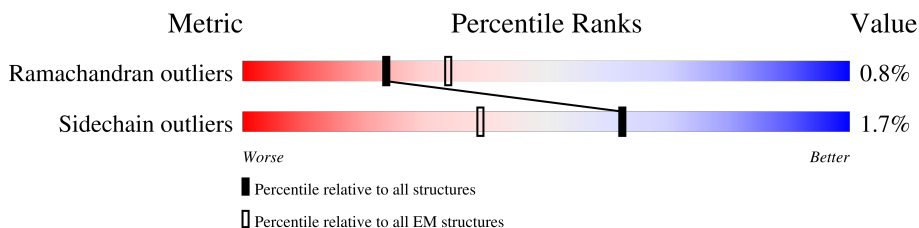

Metric	Whole archive (#Entries)	EM structures (#Entries)
Ramachandran outliers	154571	4023
Sidechain outliers	154315	3826

The table below summarises the geometric issues observed across the polymeric chains and their fit to the map. The red, orange, yellow and green segments of the bar indicate the fraction of residues that contain outliers for ≥ 3 , 2, 1 and 0 types of geometric quality criteria respectively. A grey segment represents the fraction of residues that are not modelled. The numeric value for each fraction is indicated below the corresponding segment, with a dot representing fractions $\leq 5\%$. The upper red bar (where present) indicates the fraction of residues that have poor fit to the EM map (all-atom inclusion $< 40\%$). The numeric value is given above the bar.

Mol	Chain	Length	Quality of chain
1	a	376	
2	b	377	
3	c	309	
4	d	349	
5	e	70	
6	f	908	
7	U	953	
8	V	533	
9	W	456	







Continued on next page...

Continued from previous page...

Mol	Chain	Length	Quality of chain
10	X	422	17% 55% 43%
11	Y	389	12% 96%
12	Z	324	24% 83% 5% 12%
13	A	433	27% 76% 21%
14	B	440	22% 78% 20%
15	C	394	18% 85% 6% 8%
16	D	418	18% 83% 6% 10%
17	E	403	33% 91% 7%
18	F	439	47% 81% 14%
19	G	245	11% 96%
19	g	245	6% 97%
20	H	233	8% 96%
20	h	233	12% 97%
21	I	260	12% 93% 5%
21	i	260	14% 94%
22	J	247	95%
22	j	247	13% 96%
23	K	240	5% 93% 5%
23	k	240	10% 93% 5%
24	L	268	89% 11%
24	l	268	89% 11%
25	M	254	9% 94% 6%
25	m	254	6% 94% 6%
26	N	238	80% 20%
26	n	238	79% 20%

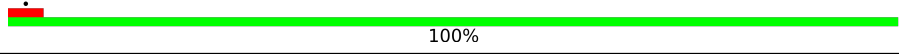
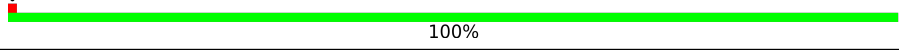
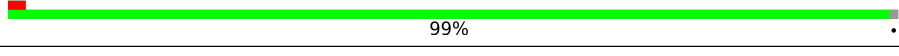
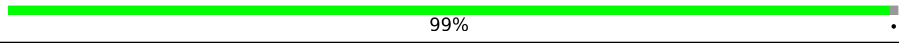
Continued on next page...

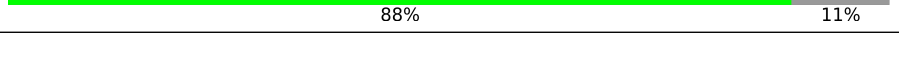
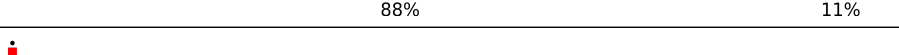
Continued from previous page...

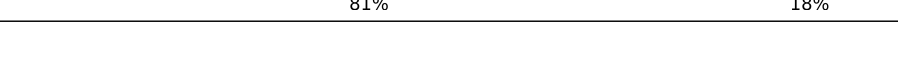
Mol	Chain	Length	Quality of chain
27	O	276	 80% 20%
27	o	276	 80% 20%
28	P	204	 100%
28	p	204	 100%
29	Q	201	 99%
29	q	201	 99%
30	R	262	 77% 23%
30	r	262	 77% 23%
31	S	240	 88% 11%
31	s	240	 88% 11%
32	T	263	 81% 18%
32	t	263	 81% 18%

2 Entry composition [i](#)

There are 34 unique types of molecules in this entry. The entry contains 99911 atoms, of which 0 are hydrogens and 0 are deuteriums.

In the tables below, the AltConf column contains the number of residues with at least one atom in alternate conformation and the Trace column contains the number of residues modelled with at most 2 atoms.

- Molecule 1 is a protein called 26S proteasome non-ATPase regulatory subunit 13.

Mol	Chain	Residues	Atoms					AltConf	Trace
			Total	C	N	O	S		
1	a	373	2995	1911	510	559	15	0	0

- Molecule 2 is a protein called 26S proteasome non-ATPase regulatory subunit 4.

Mol	Chain	Residues	Atoms					AltConf	Trace
			Total	C	N	O	S		
2	b	191	1458	910	261	279	8	0	0

- Molecule 3 is a protein called 26S proteasome non-ATPase regulatory subunit 14.

Mol	Chain	Residues	Atoms					AltConf	Trace
			Total	C	N	O	S		
3	c	278	2187	1389	374	406	18	0	0

- Molecule 4 is a protein called 26S proteasome non-ATPase regulatory subunit 8.

Mol	Chain	Residues	Atoms					AltConf	Trace
			Total	C	N	O	S		
4	d	257	2116	1371	346	390	9	0	0

- Molecule 5 is a protein called 26S proteasome complex subunit SEM1.

Mol	Chain	Residues	Atoms					AltConf	Trace
			Total	C	N	O	S		
5	e	40	334	200	55	77	2	0	0

- Molecule 6 is a protein called 26S proteasome non-ATPase regulatory subunit 2.

Mol	Chain	Residues	Atoms					AltConf	Trace
			Total	C	N	O	S		
6	f	689	5319	3343	904	1037	35	0	0

- Molecule 7 is a protein called 26S proteasome non-ATPase regulatory subunit 1.

Mol	Chain	Residues	Atoms					AltConf	Trace
			Total	C	N	O	S		
7	U	806	6287	3990	1075	1178	44	0	0

- Molecule 8 is a protein called 26S proteasome non-ATPase regulatory subunit 3.

Mol	Chain	Residues	Atoms					AltConf	Trace
			Total	C	N	O	S		
8	V	472	3799	2413	675	697	14	0	0

- Molecule 9 is a protein called 26S proteasome non-ATPase regulatory subunit 12.

Mol	Chain	Residues	Atoms					AltConf	Trace
			Total	C	N	O	S		
9	W	456	3703	2339	635	704	25	0	0

- Molecule 10 is a protein called 26S proteasome non-ATPase regulatory subunit 11.

Mol	Chain	Residues	Atoms					AltConf	Trace
			Total	C	N	O	S		
10	X	241	1905	1212	320	365	8	0	0

- Molecule 11 is a protein called 26S proteasome non-ATPase regulatory subunit 6.

Mol	Chain	Residues	Atoms					AltConf	Trace
			Total	C	N	O	S		
11	Y	378	3115	1987	533	578	17	0	0

- Molecule 12 is a protein called 26S proteasome non-ATPase regulatory subunit 7.

Mol	Chain	Residues	Atoms					AltConf	Trace
			Total	C	N	O	S		
12	Z	286	2281	1457	392	427	5	0	0

- Molecule 13 is a protein called 26S protease regulatory subunit 7.

Mol	Chain	Residues	Atoms					AltConf	Trace
			Total	C	N	O	S		
13	A	342	2672	1684	475	497	16	0	0

- Molecule 14 is a protein called 26S protease regulatory subunit 4.

Mol	Chain	Residues	Atoms					AltConf	Trace
			Total	C	N	O	S		
14	B	350	2706	1703	458	533	12	0	0

- Molecule 15 is a protein called PSMC5 isoform 15.

Mol	Chain	Residues	Atoms					AltConf	Trace
			Total	C	N	O	S		
15	C	362	2850	1799	512	522	17	0	0

- Molecule 16 is a protein called 26S protease regulatory subunit 6B.

Mol	Chain	Residues	Atoms					AltConf	Trace
			Total	C	N	O	S		
16	D	378	3021	1912	520	576	13	0	0

- Molecule 17 is a protein called 26S proteasome regulatory subunit 10B.

Mol	Chain	Residues	Atoms					AltConf	Trace
			Total	C	N	O	S		
17	E	375	2860	1796	512	536	16	0	0

- Molecule 18 is a protein called 26S protease regulatory subunit 6A.

Mol	Chain	Residues	Atoms					AltConf	Trace
			Total	C	N	O	S		
18	F	376	2859	1802	496	546	15	0	0

- Molecule 19 is a protein called Proteasome subunit alpha type-6.

Mol	Chain	Residues	Atoms					AltConf	Trace
			Total	C	N	O	S		
19	G	239	1820	1157	304	346	13	0	0
19	g	240	1826	1160	305	348	13	0	0

- Molecule 20 is a protein called Proteasome subunit alpha type-2.

Mol	Chain	Residues	Atoms					AltConf	Trace
			Total	C	N	O	S		
20	H	230	1688	1070	284	329	5	0	0
20	h	232	1708	1081	289	333	5	0	0

- Molecule 21 is a protein called Proteasome subunit alpha type-4.

Mol	Chain	Residues	Atoms					AltConf	Trace
			Total	C	N	O	S		
21	I	248	Total	C	N	O	S	0	0
			1895	1195	324	368	8		
21	i	250	Total	C	N	O	S	0	0
			1912	1204	329	371	8		

- Molecule 22 is a protein called Proteasome subunit alpha type-7.

Mol	Chain	Residues	Atoms					AltConf	Trace
			Total	C	N	O	S		
22	J	239	Total	C	N	O	S	0	0
			1704	1056	308	335	5		
22	j	239	Total	C	N	O	S	0	0
			1704	1056	308	335	5		

- Molecule 23 is a protein called Proteasome subunit alpha type-5.

Mol	Chain	Residues	Atoms					AltConf	Trace
			Total	C	N	O	S		
23	K	228	Total	C	N	O	S	0	0
			1729	1086	284	349	10		
23	k	228	Total	C	N	O	S	0	0
			1722	1080	284	348	10		

- Molecule 24 is a protein called Isoform Long of Proteasome subunit alpha type-1.

Mol	Chain	Residues	Atoms					AltConf	Trace
			Total	C	N	O	S		
24	L	238	Total	C	N	O	S	0	0
			1850	1159	334	346	11		
24	l	238	Total	C	N	O	S	0	0
			1850	1159	334	346	11		

- Molecule 25 is a protein called Proteasome subunit alpha type-3.

Mol	Chain	Residues	Atoms					AltConf	Trace
			Total	C	N	O	S		
25	M	240	Total	C	N	O	S	0	0
			1856	1178	314	353	11		
25	m	240	Total	C	N	O	S	0	0
			1856	1178	314	353	11		

- Molecule 26 is a protein called Proteasome subunit beta type-6.

Mol	Chain	Residues	Atoms					AltConf	Trace
26	N	191	Total	C	N	O	S	0	0
			1430	893	245	280	12		
26	n	191	Total	C	N	O	S	0	0
			1430	893	245	280	12		

- Molecule 27 is a protein called Proteasome subunit beta type-7.

Mol	Chain	Residues	Atoms					AltConf	Trace
27	O	220	Total	C	N	O	S	0	0
			1643	1033	280	318	12		
27	o	220	Total	C	N	O	S	0	0
			1643	1033	280	318	12		

- Molecule 28 is a protein called Proteasome subunit beta type-3.

Mol	Chain	Residues	Atoms					AltConf	Trace
28	P	204	Total	C	N	O	S	0	0
			1585	1010	262	294	19		
28	p	204	Total	C	N	O	S	0	0
			1585	1010	262	294	19		

- Molecule 29 is a protein called Proteasome subunit beta type-2.

Mol	Chain	Residues	Atoms					AltConf	Trace
29	Q	199	Total	C	N	O	S	0	0
			1570	1006	265	290	9		
29	q	199	Total	C	N	O	S	0	0
			1570	1006	265	290	9		

- Molecule 30 is a protein called Proteasome subunit beta type-5.

Mol	Chain	Residues	Atoms					AltConf	Trace
30	R	201	Total	C	N	O	S	0	0
			1548	974	273	292	9		
30	r	201	Total	C	N	O	S	0	0
			1548	974	273	292	9		

- Molecule 31 is a protein called Proteasome subunit beta type-1.

Mol	Chain	Residues	Atoms					AltConf	Trace
31	S	213	Total	C	N	O	S	0	0
			1641	1036	282	313	10		

Continued on next page...

Continued from previous page...

Mol	Chain	Residues	Atoms					AltConf	Trace
			Total	C	N	O	S		
31	s	213	Total 1641	C 1036	N 282	O 313	S 10	0	0

- Molecule 32 is a protein called Proteasome subunit beta type-4.

Mol	Chain	Residues	Atoms					AltConf	Trace
			Total	C	N	O	S		
32	T	215	Total 1667	C 1052	N 285	O 318	S 12	0	0
32	t	215	Total 1667	C 1052	N 285	O 318	S 12	0	0

- Molecule 33 is ZINC ION (three-letter code: ZN) (formula: Zn) (labeled as "Ligand of Interest" by depositor).

Mol	Chain	Residues	Atoms		AltConf
			Total	Zn	
33	c	1	Total 1	Zn 1	0

- Molecule 34 is ADENOSINE-5'-TRIPHOSPHATE (three-letter code: ATP) (formula: C₁₀H₁₆N₅O₁₃P₃) (labeled as "Ligand of Interest" by depositor).

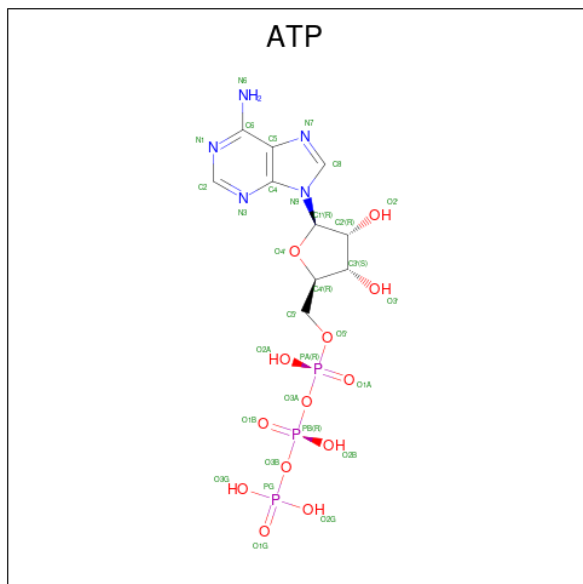

Mol	Chain	Residues	Atoms					AltConf
			Total	C	N	O	P	
34	A	1	Total 31	C 10	N 5	O 13	P 3	0
34	B	1	Total 31	C 10	N 5	O 13	P 3	0

Continued on next page...

Continued from previous page...

Mol	Chain	Residues	Atoms					AltConf
			Total	C	N	O	P	
34	D	1	Total 62	20	10	26	6	0
34	D	1	Total 62	20	10	26	6	0
34	E	1	Total 31	10	5	13	3	0

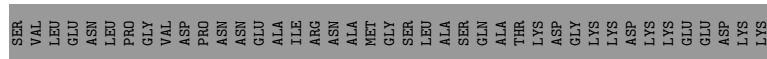

• Molecule 3: 26S proteasome non-ATPase regulatory subunit 14

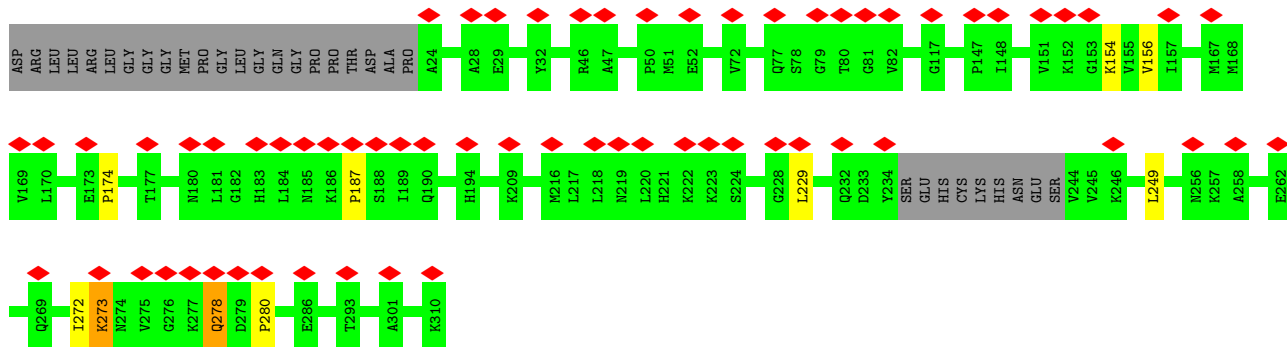
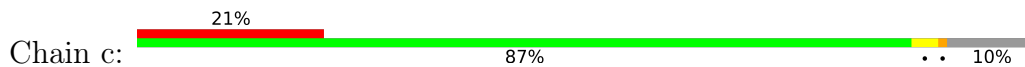

• Molecule 4: 26S proteasome non-ATPase regulatory subunit 8

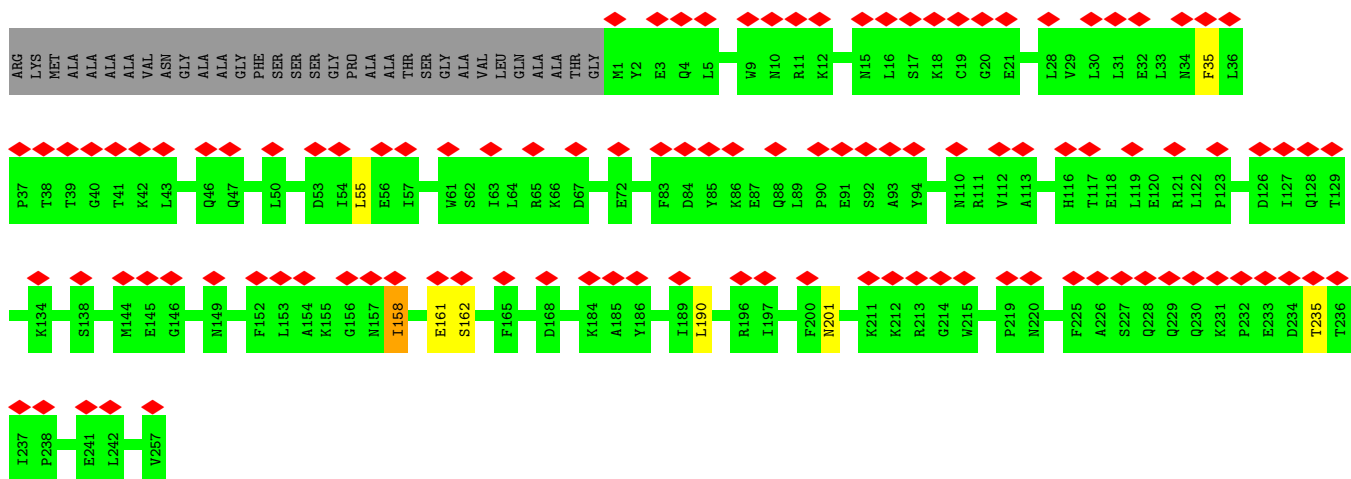
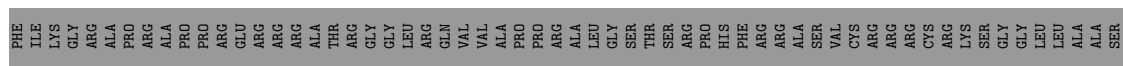

• Molecule 5: 26S proteasome complex subunit SEM1

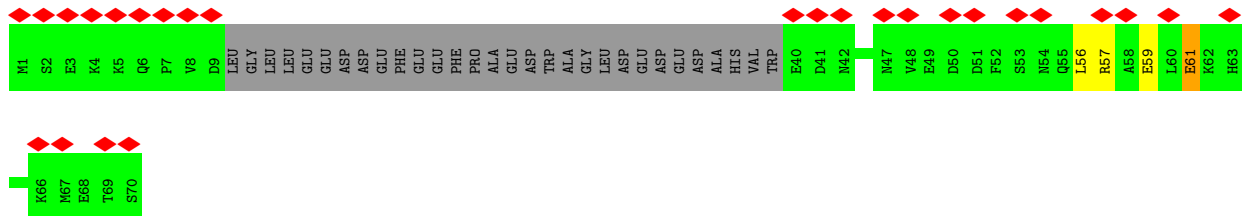

• Molecule 6: 26S proteasome non-ATPase regulatory subunit 2

• Molecule 7: 26S proteasome non-ATPase regulatory subunit 1

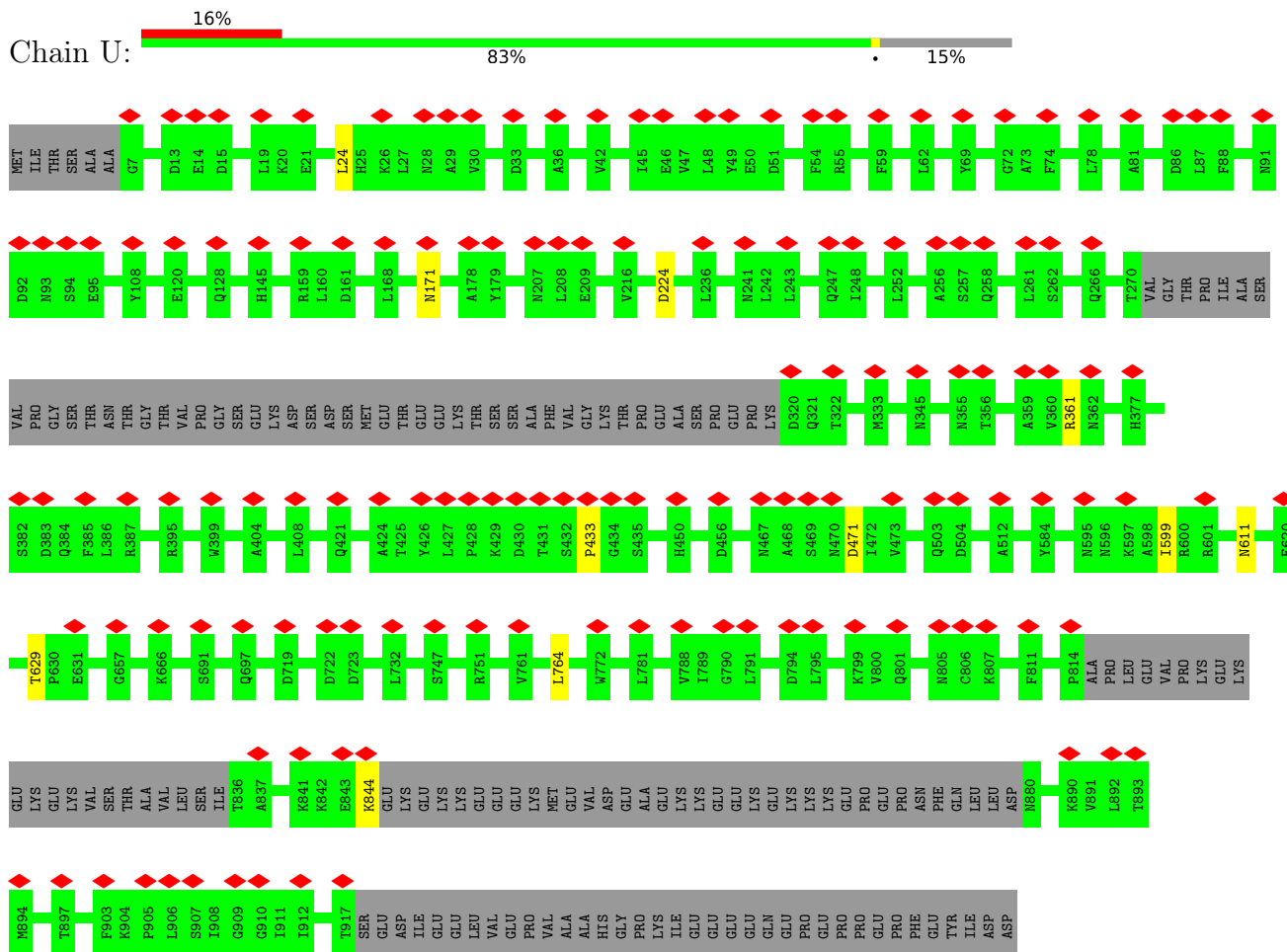

• Molecule 8: 26S proteasome non-ATPase regulatory subunit 3

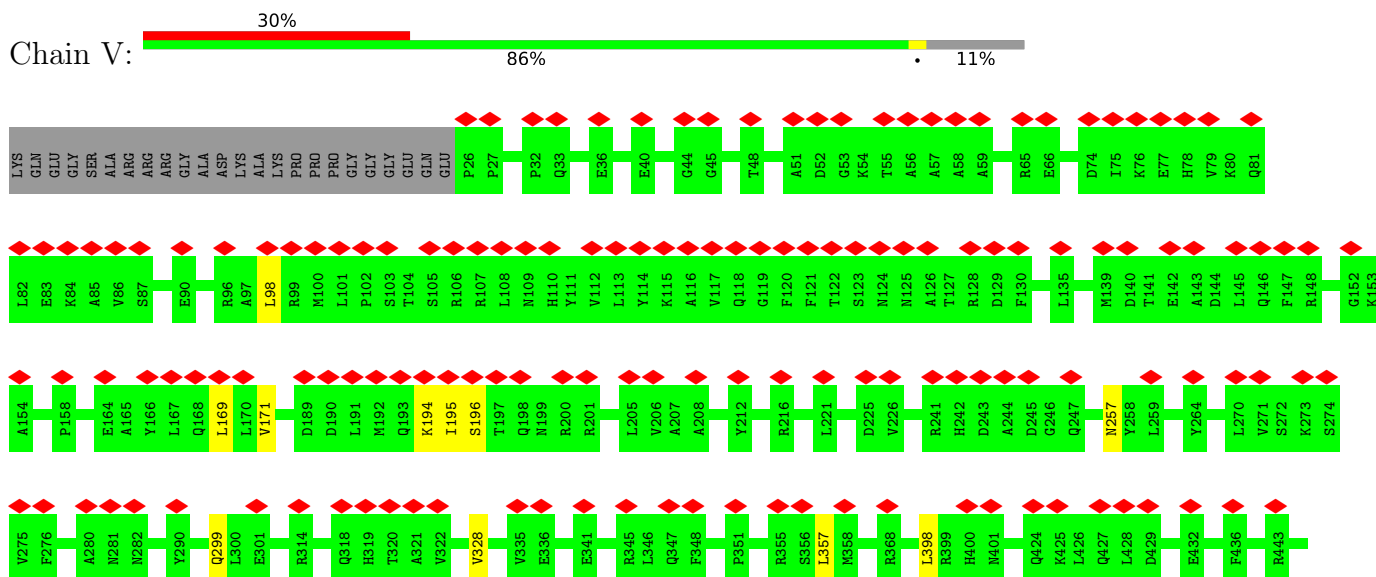

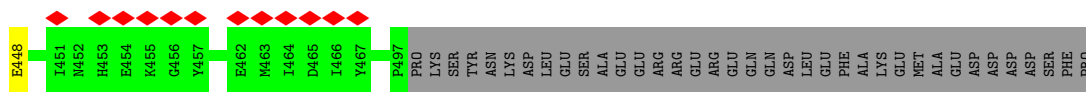

- Molecule 9: 26S proteasome non-ATPase regulatory subunit 12

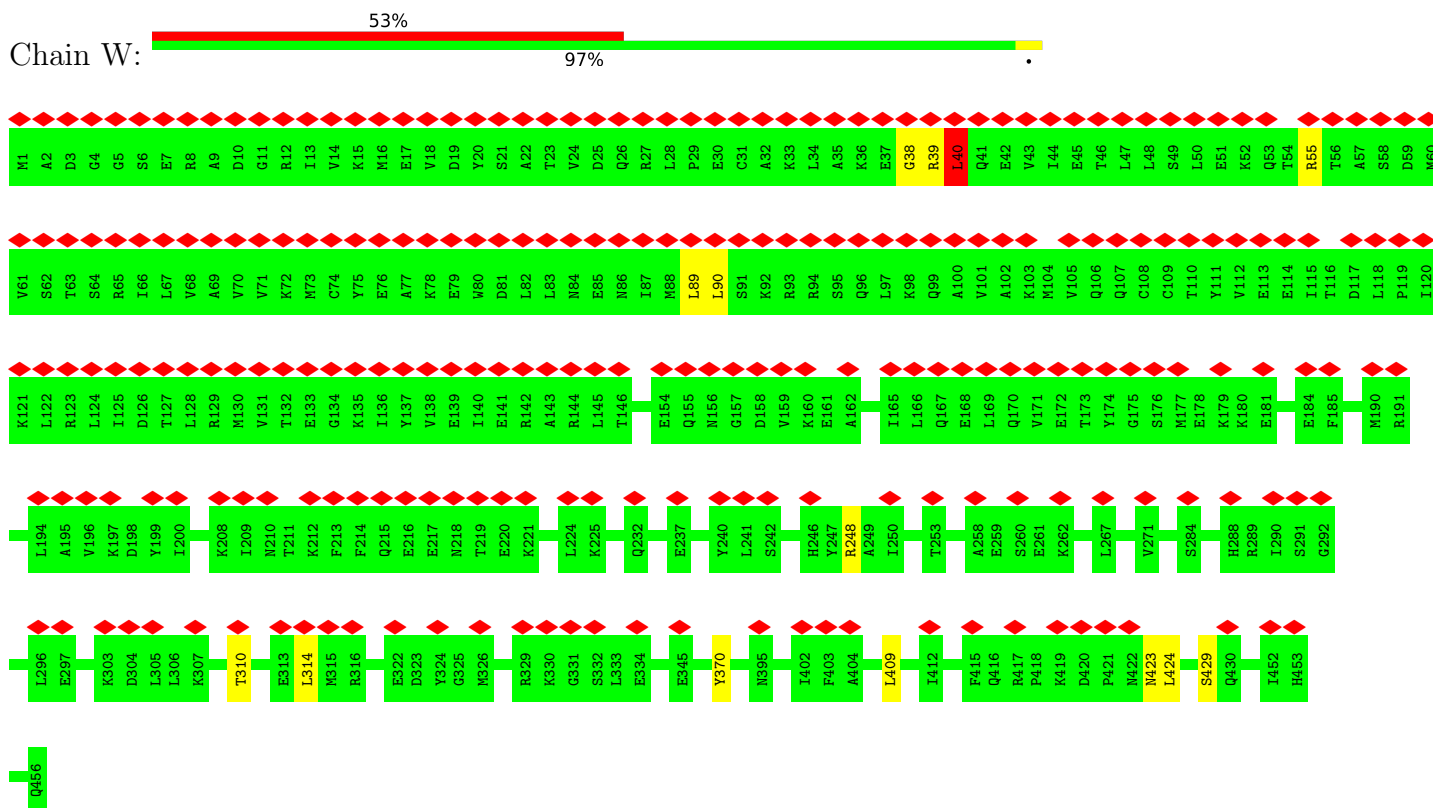

- Molecule 10: 26S proteasome non-ATPase regulatory subunit 11

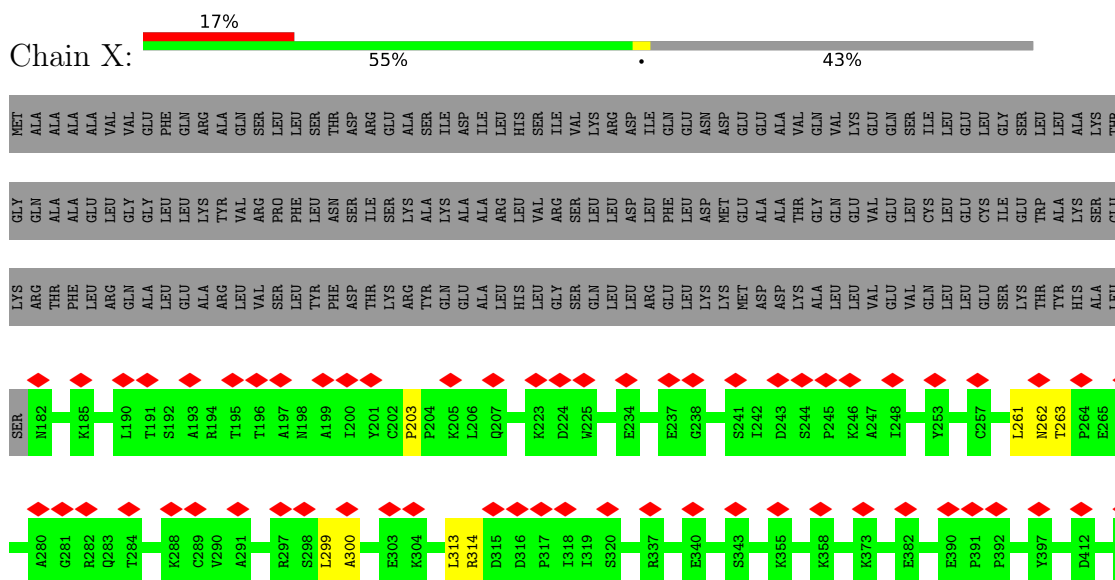

- Molecule 11: 26S proteasome non-ATPase regulatory subunit 6



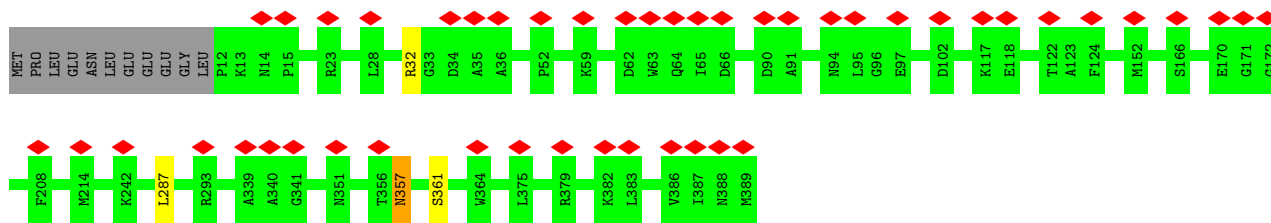

• Molecule 12: 26S proteasome non-ATPase regulatory subunit 7

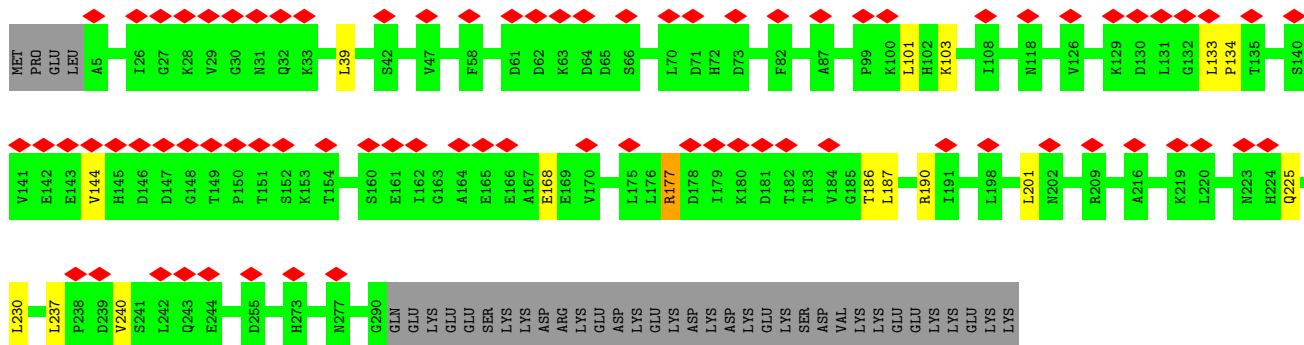
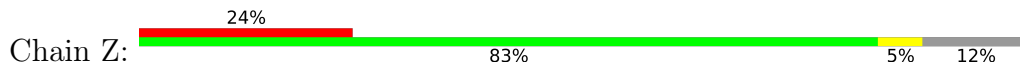

• Molecule 13: 26S protease regulatory subunit 7

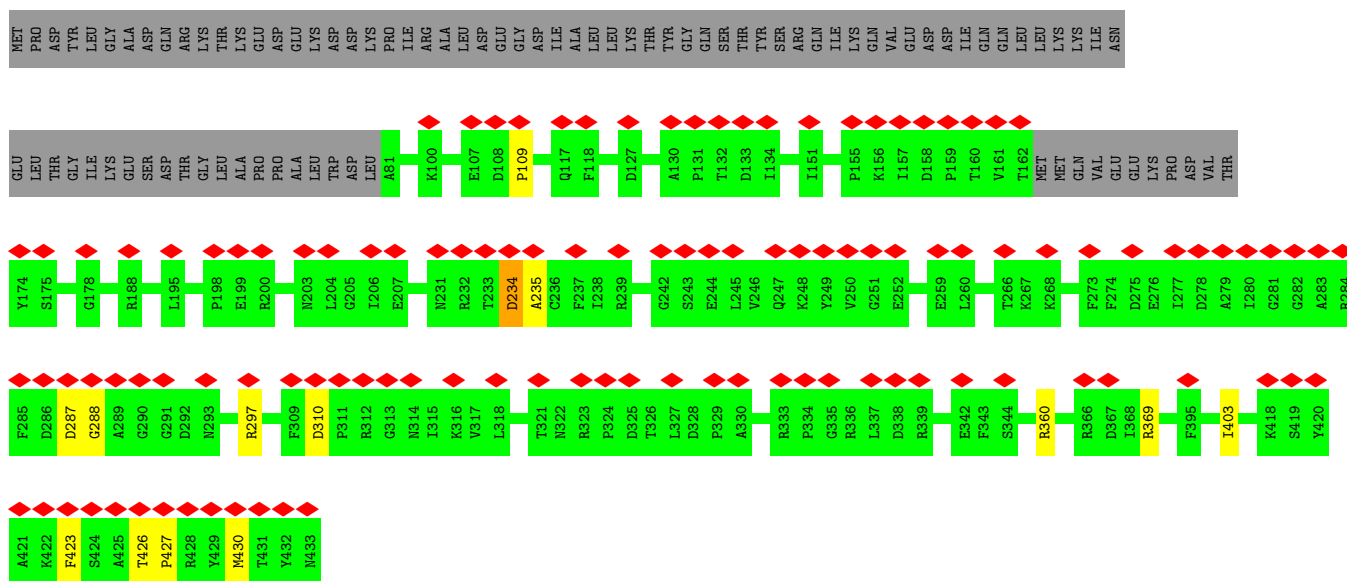
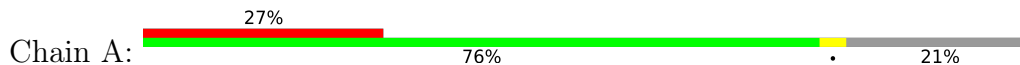

• Molecule 14: 26S protease regulatory subunit 4

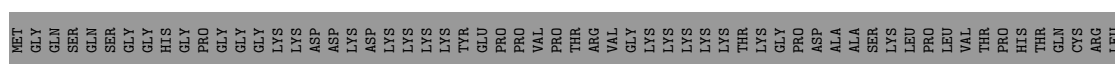
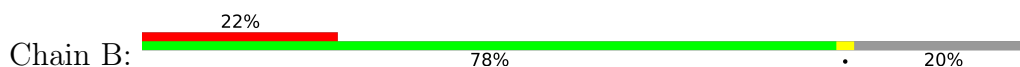

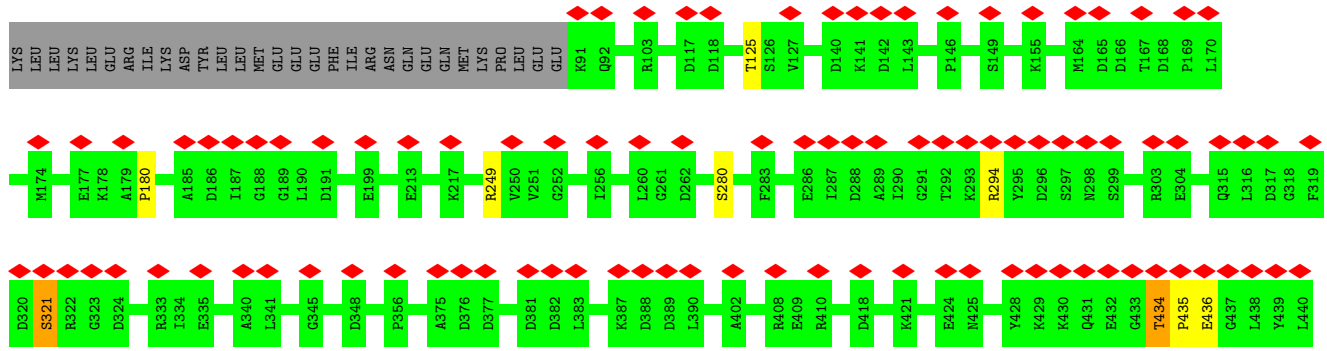

• Molecule 15: PSMC5 isoform 15

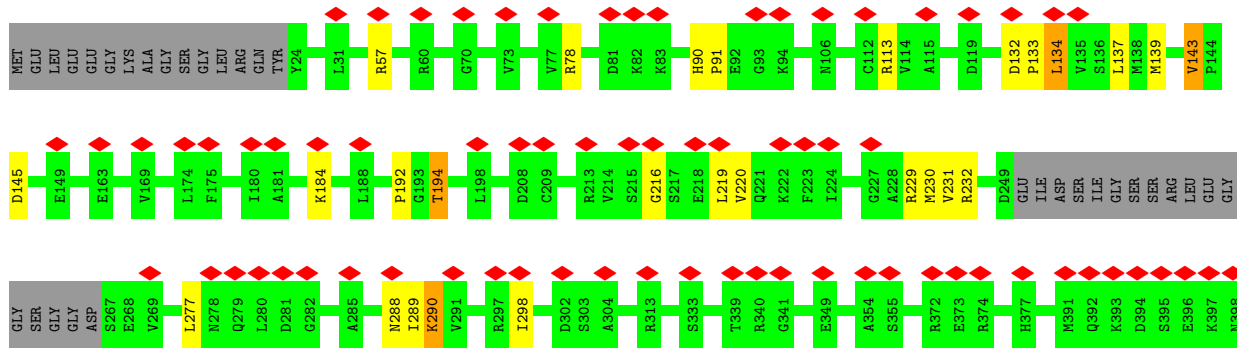
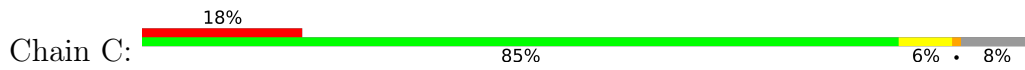

• Molecule 16: 26S protease regulatory subunit 6B

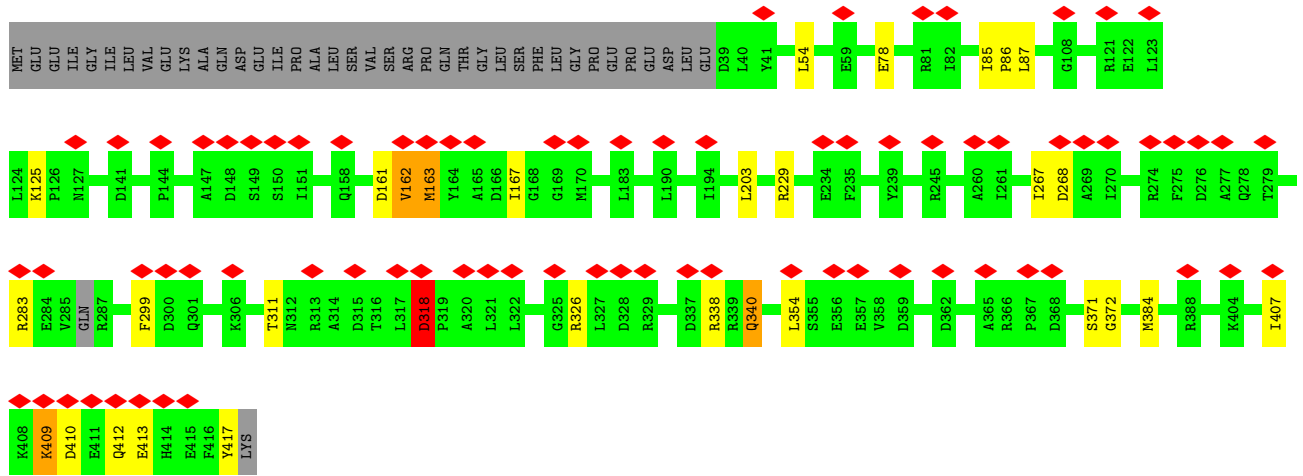
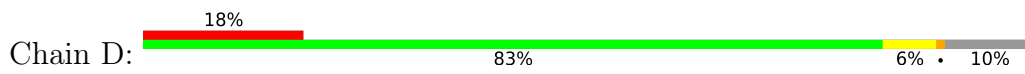

• Molecule 17: 26S proteasome regulatory subunit 10B

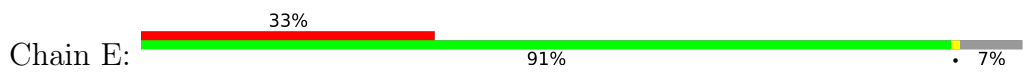

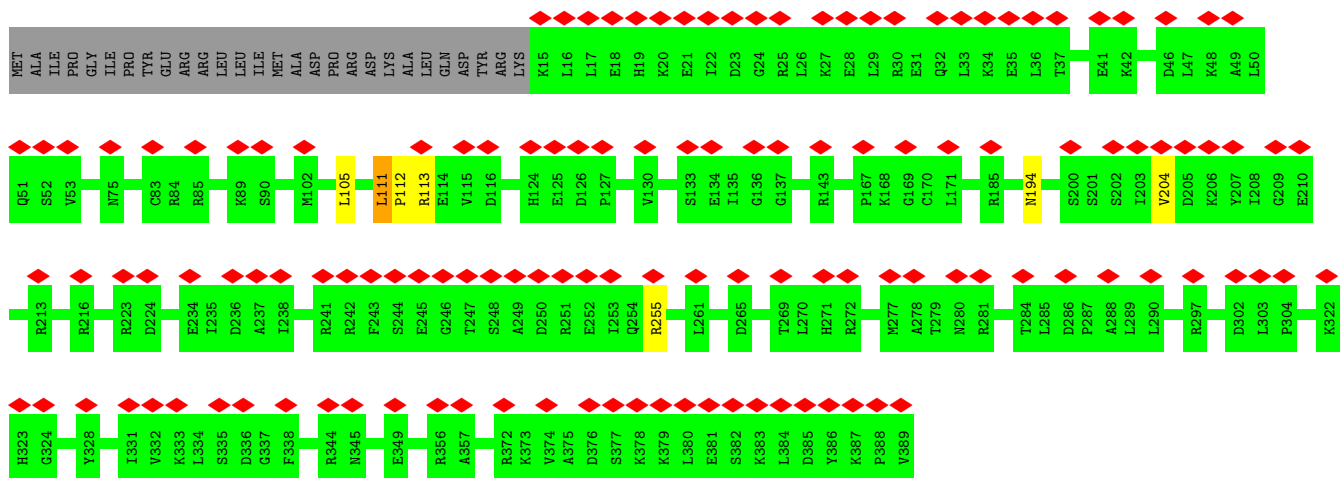

• Molecule 18: 26S protease regulatory subunit 6A

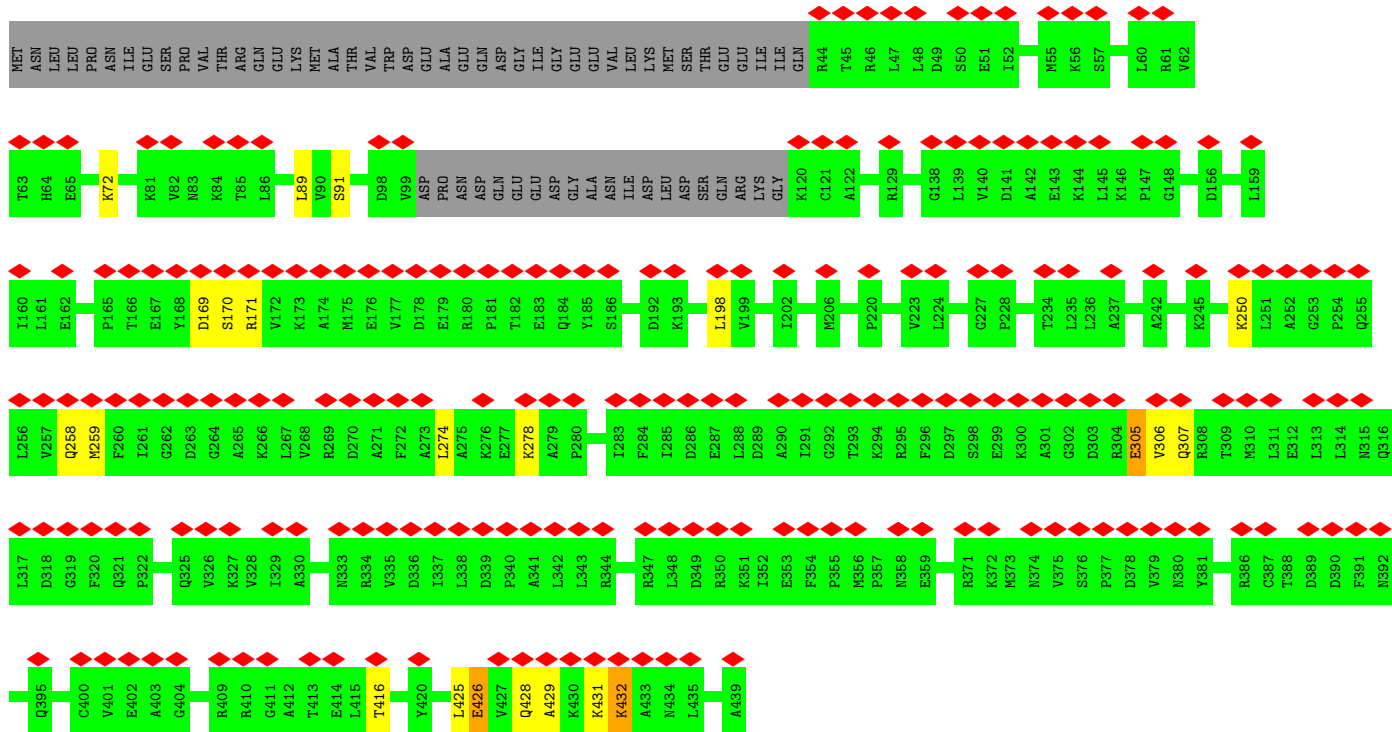
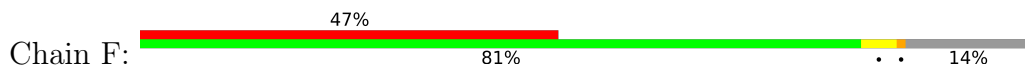

• Molecule 19: Proteasome subunit alpha type-6

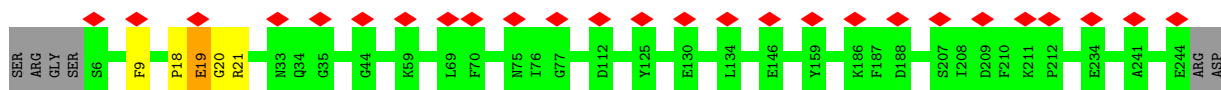

• Molecule 19: Proteasome subunit alpha type-6

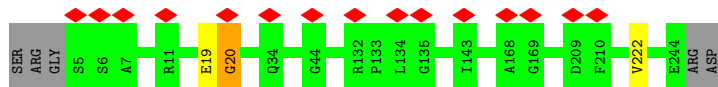

• Molecule 20: Proteasome subunit alpha type-2

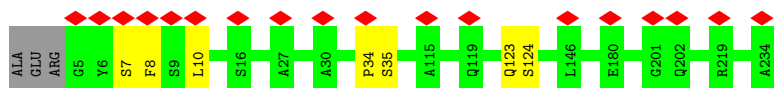

• Molecule 20: Proteasome subunit alpha type-2

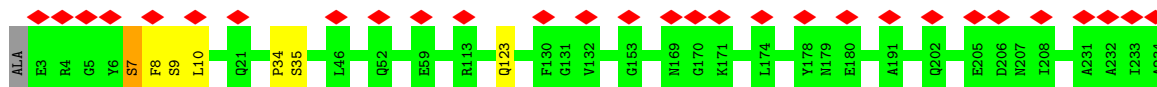

• Molecule 21: Proteasome subunit alpha type-4

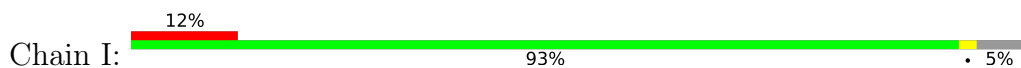

• Molecule 21: Proteasome subunit alpha type-4

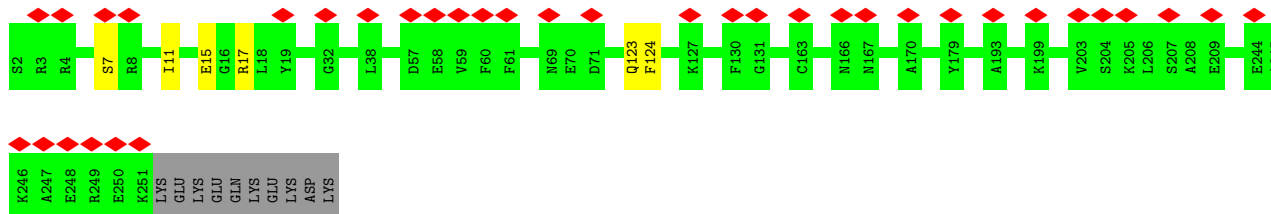
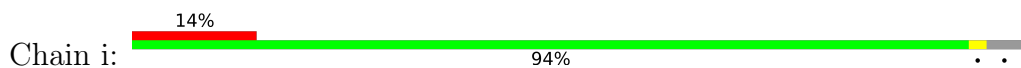

• Molecule 22: Proteasome subunit alpha type-7

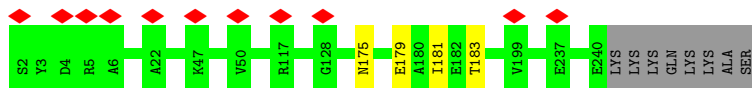
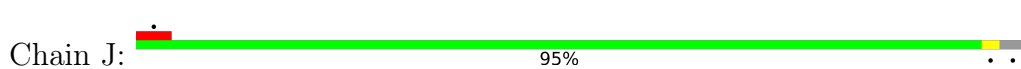

• Molecule 22: Proteasome subunit alpha type-7

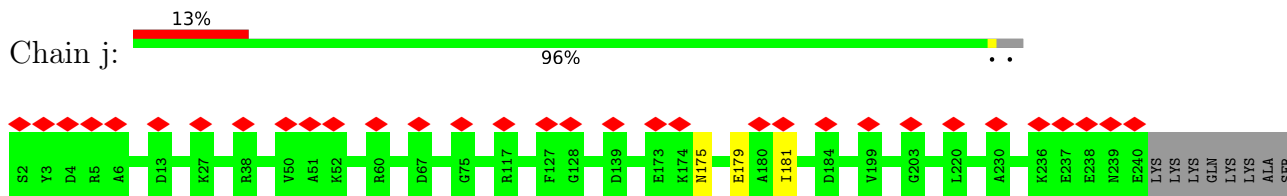

• Molecule 23: Proteasome subunit alpha type-5

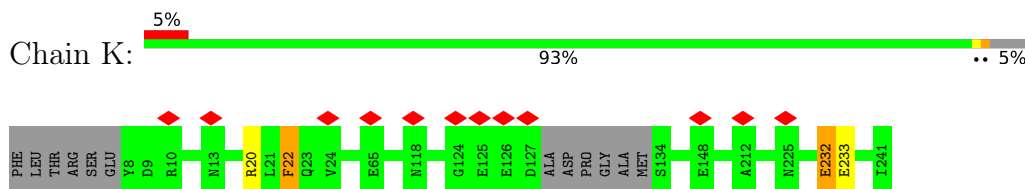

• Molecule 23: Proteasome subunit alpha type-5

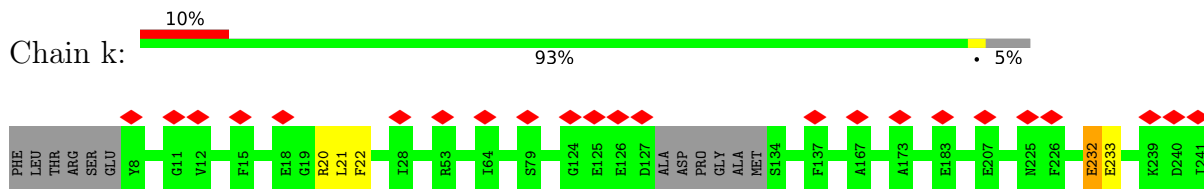

• Molecule 24: Isoform Long of Proteasome subunit alpha type-1

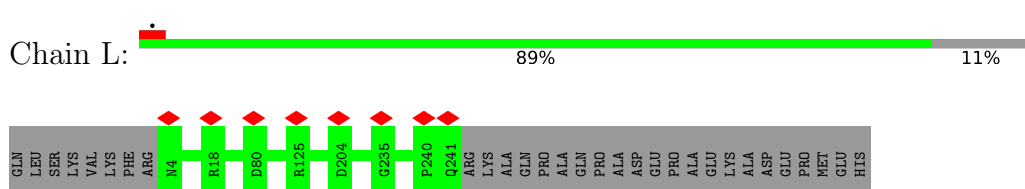

• Molecule 24: Isoform Long of Proteasome subunit alpha type-1

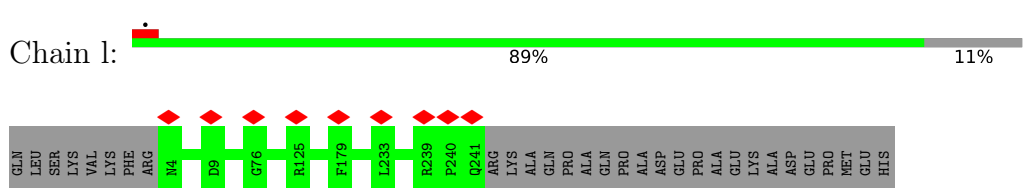

• Molecule 25: Proteasome subunit alpha type-3

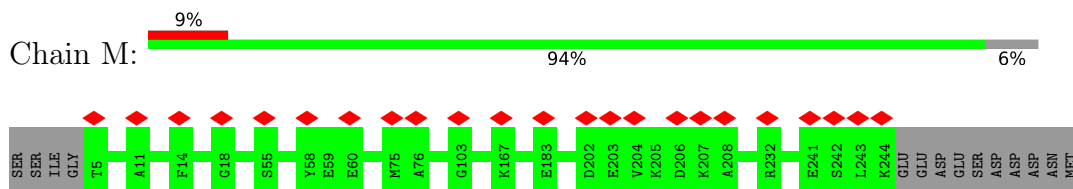

• Molecule 25: Proteasome subunit alpha type-3



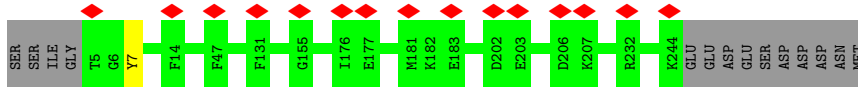

• Molecule 26: Proteasome subunit beta type-6

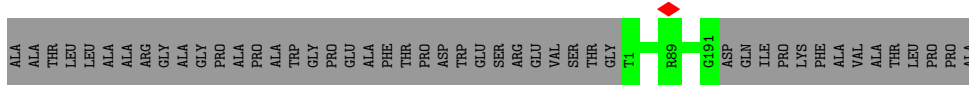
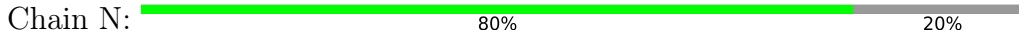

• Molecule 26: Proteasome subunit beta type-6

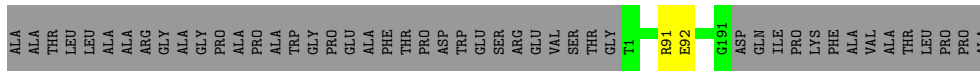
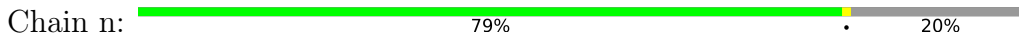

• Molecule 27: Proteasome subunit beta type-7

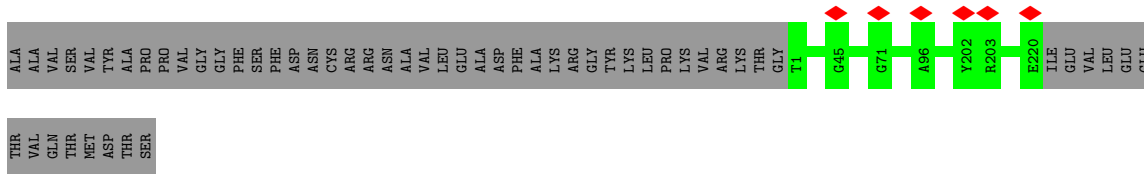
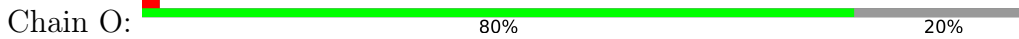

• Molecule 27: Proteasome subunit beta type-7

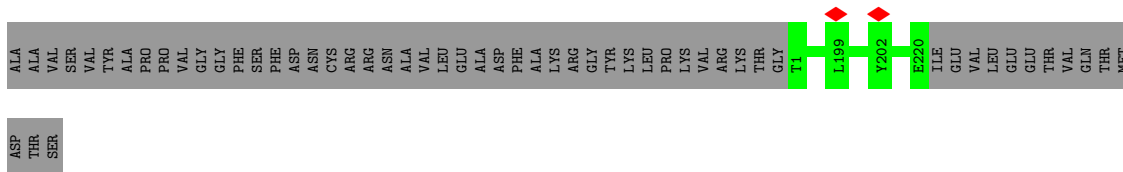
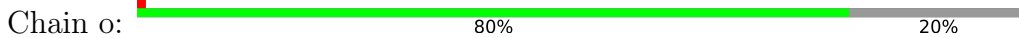

• Molecule 28: Proteasome subunit beta type-3

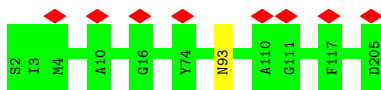

• Molecule 28: Proteasome subunit beta type-3





• Molecule 29: Proteasome subunit beta type-2

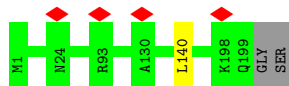

• Molecule 29: Proteasome subunit beta type-2

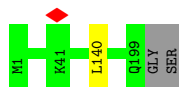

• Molecule 30: Proteasome subunit beta type-5

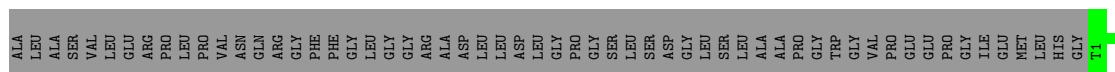
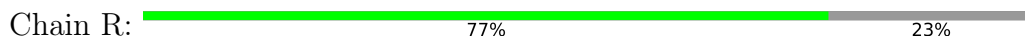

• Molecule 30: Proteasome subunit beta type-5

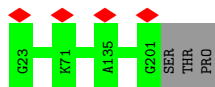
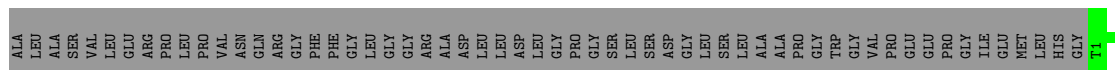

• Molecule 31: Proteasome subunit beta type-1

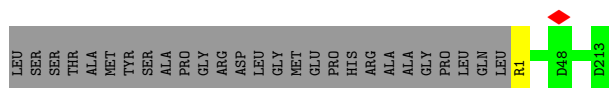
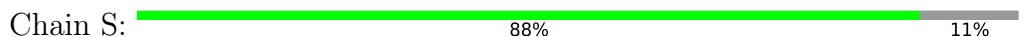

• Molecule 31: Proteasome subunit beta type-1

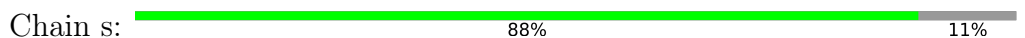

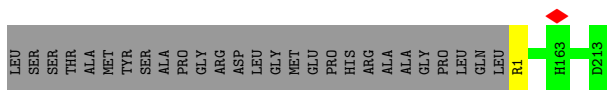

- Molecule 32: Proteasome subunit beta type-4

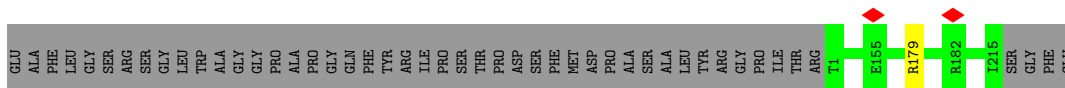
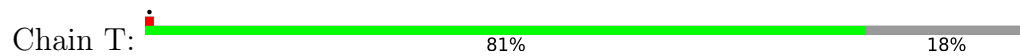

- Molecule 32: Proteasome subunit beta type-4

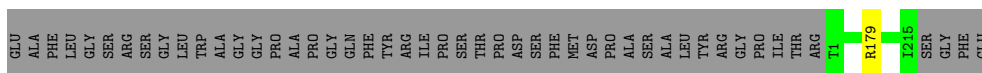
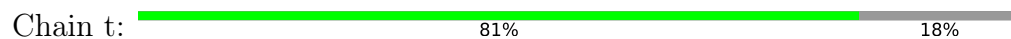

4 Experimental information

Property	Value	Source
EM reconstruction method	SINGLE PARTICLE	Depositor
Imposed symmetry	POINT, Not provided	
Number of particles used	34363	Depositor
Resolution determination method	FSC 0.143 CUT-OFF	Depositor
CTF correction method	PHASE FLIPPING AND AMPLITUDE CORRECTION	Depositor
Microscope	FEI TITAN KRIOS	Depositor
Voltage (kV)	300	Depositor
Electron dose ($e^-/\text{\AA}^2$)	46.6	Depositor
Minimum defocus (nm)	800	Depositor
Maximum defocus (nm)	2500	Depositor
Magnification	Not provided	
Image detector	GATAN K2 QUANTUM (4k x 4k)	Depositor
Maximum map value	0.100	Depositor
Minimum map value	-0.037	Depositor
Average map value	0.001	Depositor
Map value standard deviation	0.006	Depositor
Recommended contour level	0.0315	Depositor
Map size (Å)	438.4, 438.4, 438.4	wwPDB
Map dimensions	320, 320, 320	wwPDB
Map angles (°)	90.0, 90.0, 90.0	wwPDB
Pixel spacing (Å)	1.37, 1.37, 1.37	Depositor

5 Model quality [i](#)

5.1 Standard geometry [i](#)

Bond lengths and bond angles in the following residue types are not validated in this section: ATP, ZN

The Z score for a bond length (or angle) is the number of standard deviations the observed value is removed from the expected value. A bond length (or angle) with $|Z| > 5$ is considered an outlier worth inspection. RMSZ is the root-mean-square of all Z scores of the bond lengths (or angles).

Mol	Chain	Bond lengths		Bond angles	
		RMSZ	# Z >5	RMSZ	# Z >5
1	a	0.34	0/3053	0.65	1/4133 (0.0%)
2	b	0.33	0/1478	0.63	1/2001 (0.0%)
3	c	0.38	0/2226	0.70	1/3007 (0.0%)
4	d	0.36	0/2162	0.68	2/2919 (0.1%)
5	e	0.37	0/338	0.68	0/450
6	f	0.32	0/5393	0.68	2/7271 (0.0%)
7	U	0.36	0/6396	0.65	3/8646 (0.0%)
8	V	0.39	0/3874	0.71	2/5234 (0.0%)
9	W	0.35	0/3751	0.69	3/5042 (0.1%)
10	X	0.39	0/1936	0.64	0/2614
11	Y	0.41	0/3173	0.65	0/4273
12	Z	0.37	0/2324	0.72	3/3150 (0.1%)
13	A	0.36	0/2717	0.64	1/3665 (0.0%)
14	B	0.36	0/2745	0.59	0/3709
15	C	0.37	0/2887	0.74	4/3883 (0.1%)
16	D	0.43	0/3070	0.80	2/4142 (0.0%)
17	E	0.35	0/2904	0.61	0/3924
18	F	0.33	0/2897	0.63	2/3912 (0.1%)
19	G	0.37	0/1853	0.58	0/2515
19	g	0.38	0/1859	0.60	1/2523 (0.0%)
20	H	0.39	0/1723	0.61	1/2346 (0.0%)
20	h	0.39	0/1743	0.58	0/2372
21	I	0.38	0/1925	0.61	0/2606
21	i	0.37	0/1942	0.62	0/2628
22	J	0.35	0/1728	0.55	0/2358
22	j	0.35	0/1728	0.56	0/2358
23	K	0.38	0/1755	0.59	1/2375 (0.0%)
23	k	0.38	0/1747	0.59	1/2364 (0.0%)
24	L	0.39	0/1885	0.60	0/2552
24	l	0.39	0/1885	0.60	0/2552
25	M	0.41	0/1891	0.60	0/2552
25	m	0.40	0/1891	0.60	0/2552

Mol	Chain	Bond lengths		Bond angles	
		RMSZ	# Z >5	RMSZ	# Z >5
26	N	0.40	0/1454	0.57	0/1967
26	n	0.40	0/1454	0.57	0/1967
27	O	0.38	0/1670	0.56	0/2265
27	o	0.38	0/1670	0.56	0/2265
28	P	0.39	0/1614	0.56	0/2177
28	p	0.39	0/1614	0.56	0/2177
29	Q	0.42	0/1603	0.59	0/2174
29	q	0.42	0/1603	0.59	0/2174
30	R	0.42	0/1579	0.55	0/2134
30	r	0.42	0/1579	0.55	0/2134
31	S	0.41	0/1671	0.56	0/2253
31	s	0.41	0/1671	0.56	0/2253
32	T	0.41	0/1700	0.58	0/2305
32	t	0.41	0/1700	0.58	0/2305
All	All	0.38	0/101461	0.63	31/137178 (0.0%)

There are no bond length outliers.

The worst 5 of 31 bond angle outliers are listed below:

Mol	Chain	Res	Type	Atoms	Z	Observed(°)	Ideal(°)
15	C	134	LEU	CA-CB-CG	9.15	136.35	115.30
6	f	372	LEU	CA-CB-CG	5.92	128.93	115.30
15	C	219	LEU	CA-CB-CG	5.91	128.89	115.30
18	F	198	LEU	CA-CB-CG	5.89	128.85	115.30
23	K	233	GLU	N-CA-C	-5.85	95.21	111.00

There are no chirality outliers.

There are no planarity outliers.

5.2 Too-close contacts [i](#)

Due to software issues we are unable to calculate clashes - this section is therefore empty.

5.3 Torsion angles [i](#)

5.3.1 Protein backbone [i](#)

In the following table, the Percentiles column shows the percent Ramachandran outliers of the chain as a percentile score with respect to all PDB entries followed by that with respect to all EM entries.

The Analysed column shows the number of residues for which the backbone conformation was analysed, and the total number of residues.

Mol	Chain	Analysed	Favoured	Allowed	Outliers	Percentiles	
1	a	371/376 (99%)	331 (89%)	38 (10%)	2 (0%)	29	68
2	b	189/377 (50%)	160 (85%)	28 (15%)	1 (0%)	29	68
3	c	274/309 (89%)	228 (83%)	40 (15%)	6 (2%)	6	37
4	d	255/349 (73%)	216 (85%)	36 (14%)	3 (1%)	13	50
5	e	36/70 (51%)	21 (58%)	14 (39%)	1 (3%)	5	33
6	f	669/908 (74%)	591 (88%)	75 (11%)	3 (0%)	34	72
7	U	798/953 (84%)	729 (91%)	68 (8%)	1 (0%)	51	85
8	V	470/533 (88%)	396 (84%)	70 (15%)	4 (1%)	17	56
9	W	454/456 (100%)	393 (87%)	56 (12%)	5 (1%)	14	52
10	X	239/422 (57%)	211 (88%)	25 (10%)	3 (1%)	12	48
11	Y	376/389 (97%)	331 (88%)	43 (11%)	2 (0%)	29	68
12	Z	284/324 (88%)	237 (84%)	42 (15%)	5 (2%)	8	41
13	A	338/433 (78%)	269 (80%)	63 (19%)	6 (2%)	8	41
14	B	348/440 (79%)	307 (88%)	37 (11%)	4 (1%)	14	52
15	C	358/394 (91%)	285 (80%)	58 (16%)	15 (4%)	3	25
16	D	374/418 (90%)	287 (77%)	72 (19%)	15 (4%)	3	25
17	E	373/403 (93%)	330 (88%)	40 (11%)	3 (1%)	19	60
18	F	372/439 (85%)	326 (88%)	38 (10%)	8 (2%)	6	37
19	G	237/245 (97%)	210 (89%)	23 (10%)	4 (2%)	9	43
19	g	238/245 (97%)	212 (89%)	24 (10%)	2 (1%)	19	60
20	H	228/233 (98%)	207 (91%)	19 (8%)	2 (1%)	17	56
20	h	230/233 (99%)	207 (90%)	21 (9%)	2 (1%)	17	56
21	I	246/260 (95%)	222 (90%)	23 (9%)	1 (0%)	34	72
21	i	248/260 (95%)	224 (90%)	23 (9%)	1 (0%)	34	72
22	J	237/247 (96%)	215 (91%)	20 (8%)	2 (1%)	19	60
22	j	237/247 (96%)	217 (92%)	18 (8%)	2 (1%)	19	60
23	K	224/240 (93%)	201 (90%)	21 (9%)	2 (1%)	17	56
23	k	224/240 (93%)	202 (90%)	21 (9%)	1 (0%)	34	72
24	L	236/268 (88%)	221 (94%)	15 (6%)	0	100	100
24	l	236/268 (88%)	221 (94%)	15 (6%)	0	100	100

Continued on next page...

Continued from previous page...

Mol	Chain	Analysed	Favoured	Allowed	Outliers	Percentiles	
25	M	238/254 (94%)	213 (90%)	25 (10%)	0	100	100
25	m	238/254 (94%)	214 (90%)	24 (10%)	0	100	100
26	N	189/238 (79%)	178 (94%)	11 (6%)	0	100	100
26	n	189/238 (79%)	178 (94%)	10 (5%)	1 (0%)	29	68
27	O	218/276 (79%)	202 (93%)	16 (7%)	0	100	100
27	o	218/276 (79%)	202 (93%)	16 (7%)	0	100	100
28	P	202/204 (99%)	194 (96%)	8 (4%)	0	100	100
28	p	202/204 (99%)	194 (96%)	8 (4%)	0	100	100
29	Q	197/201 (98%)	178 (90%)	19 (10%)	0	100	100
29	q	197/201 (98%)	178 (90%)	19 (10%)	0	100	100
30	R	199/262 (76%)	187 (94%)	12 (6%)	0	100	100
30	r	199/262 (76%)	187 (94%)	12 (6%)	0	100	100
31	S	211/240 (88%)	202 (96%)	9 (4%)	0	100	100
31	s	211/240 (88%)	202 (96%)	9 (4%)	0	100	100
32	T	213/263 (81%)	201 (94%)	12 (6%)	0	100	100
32	t	213/263 (81%)	201 (94%)	12 (6%)	0	100	100
All	All	12733/14855 (86%)	11318 (89%)	1308 (10%)	107 (1%)	24	60

5 of 107 Ramachandran outliers are listed below:

Mol	Chain	Res	Type
2	b	103	LYS
4	d	201	ASN
9	W	314	LEU
9	W	424	LEU
10	X	203	PRO

5.3.2 Protein sidechains [i](#)

In the following table, the Percentiles column shows the percent sidechain outliers of the chain as a percentile score with respect to all PDB entries followed by that with respect to all EM entries.

The Analysed column shows the number of residues for which the sidechain conformation was analysed, and the total number of residues.

Mol	Chain	Analysed	Rotameric	Outliers	Percentiles	
1	a	333/336 (99%)	332 (100%)	1 (0%)	92	95
2	b	167/312 (54%)	165 (99%)	2 (1%)	71	84
3	c	243/267 (91%)	238 (98%)	5 (2%)	53	72
4	d	231/293 (79%)	227 (98%)	4 (2%)	60	78
5	e	38/63 (60%)	34 (90%)	4 (10%)	7	26
6	f	580/763 (76%)	568 (98%)	12 (2%)	53	72
7	U	685/816 (84%)	678 (99%)	7 (1%)	76	86
8	V	409/459 (89%)	403 (98%)	6 (2%)	65	80
9	W	416/416 (100%)	408 (98%)	8 (2%)	57	75
10	X	208/362 (58%)	203 (98%)	5 (2%)	49	69
11	Y	334/344 (97%)	331 (99%)	3 (1%)	78	88
12	Z	257/295 (87%)	248 (96%)	9 (4%)	36	60
13	A	286/372 (77%)	278 (97%)	8 (3%)	43	65
14	B	300/385 (78%)	293 (98%)	7 (2%)	50	70
15	C	314/342 (92%)	302 (96%)	12 (4%)	33	58
16	D	331/366 (90%)	311 (94%)	20 (6%)	19	46
17	E	298/353 (84%)	293 (98%)	5 (2%)	60	78
18	F	296/379 (78%)	281 (95%)	15 (5%)	24	50
19	G	192/209 (92%)	190 (99%)	2 (1%)	76	86
19	g	193/209 (92%)	192 (100%)	1 (0%)	88	93
20	H	162/190 (85%)	158 (98%)	4 (2%)	47	68
20	h	164/190 (86%)	158 (96%)	6 (4%)	34	59
21	I	191/220 (87%)	186 (97%)	5 (3%)	46	67
21	i	193/220 (88%)	188 (97%)	5 (3%)	46	67
22	J	152/210 (72%)	150 (99%)	2 (1%)	69	82
22	j	152/210 (72%)	151 (99%)	1 (1%)	84	90
23	K	187/202 (93%)	184 (98%)	3 (2%)	62	79
23	k	186/202 (92%)	182 (98%)	4 (2%)	52	71
24	L	198/229 (86%)	198 (100%)	0	100	100
24	l	198/229 (86%)	198 (100%)	0	100	100
25	M	192/211 (91%)	192 (100%)	0	100	100
25	m	192/211 (91%)	191 (100%)	1 (0%)	88	93

Continued on next page...

Continued from previous page...

Mol	Chain	Analysed	Rotameric	Outliers	Percentiles	
26	N	148/180 (82%)	148 (100%)	0	100	100
26	n	148/180 (82%)	147 (99%)	1 (1%)	84	90
27	O	177/227 (78%)	177 (100%)	0	100	100
27	o	177/227 (78%)	177 (100%)	0	100	100
28	P	172/173 (99%)	171 (99%)	1 (1%)	86	92
28	p	172/173 (99%)	171 (99%)	1 (1%)	86	92
29	Q	164/171 (96%)	163 (99%)	1 (1%)	86	92
29	q	164/171 (96%)	163 (99%)	1 (1%)	86	92
30	R	153/201 (76%)	153 (100%)	0	100	100
30	r	153/201 (76%)	153 (100%)	0	100	100
31	S	174/198 (88%)	173 (99%)	1 (1%)	86	92
31	s	174/198 (88%)	173 (99%)	1 (1%)	86	92
32	T	175/214 (82%)	174 (99%)	1 (1%)	86	92
32	t	175/214 (82%)	174 (99%)	1 (1%)	86	92
All	All	10604/12593 (84%)	10428 (98%)	176 (2%)	62	78

5 of 176 residues with a non-rotameric sidechain are listed below:

Mol	Chain	Res	Type
17	E	194	ASN
21	I	127	LYS
18	F	91	SER
18	F	428	GLN
29	Q	140	LEU

Sometimes sidechains can be flipped to improve hydrogen bonding and reduce clashes. 5 of 98 such sidechains are listed below:

Mol	Chain	Res	Type
22	J	116	GLN
29	Q	186	ASN
22	J	175	ASN
27	O	62	ASN
19	g	127	GLN

5.3.3 RNA [i](#)

There are no RNA molecules in this entry.

5.4 Non-standard residues in protein, DNA, RNA chains [i](#)

There are no non-standard protein/DNA/RNA residues in this entry.

5.5 Carbohydrates [i](#)

There are no monosaccharides in this entry.

5.6 Ligand geometry [i](#)

Of 6 ligands modelled in this entry, 1 is monoatomic - leaving 5 for Mogul analysis.

In the following table, the Counts columns list the number of bonds (or angles) for which Mogul statistics could be retrieved, the number of bonds (or angles) that are observed in the model and the number of bonds (or angles) that are defined in the Chemical Component Dictionary. The Link column lists molecule types, if any, to which the group is linked. The Z score for a bond length (or angle) is the number of standard deviations the observed value is removed from the expected value. A bond length (or angle) with $|Z| > 2$ is considered an outlier worth inspection. RMSZ is the root-mean-square of all Z scores of the bond lengths (or angles).

Mol	Type	Chain	Res	Link	Bond lengths			Bond angles		
					Counts	RMSZ	# Z > 2	Counts	RMSZ	# Z > 2
34	ATP	A	501	-	26,33,33	2.77	1 (3%)	31,52,52	1.46	3 (9%)
34	ATP	B	501	-	26,33,33	0.94	1 (3%)	31,52,52	1.61	5 (16%)
34	ATP	E	401	17	26,33,33	0.88	1 (3%)	31,52,52	1.78	7 (22%)
34	ATP	D	502	-	26,33,33	2.77	1 (3%)	31,52,52	1.57	3 (9%)
34	ATP	D	501	16	26,33,33	0.88	1 (3%)	31,52,52	1.78	7 (22%)

In the following table, the Chirals column lists the number of chiral outliers, the number of chiral centers analysed, the number of these observed in the model and the number defined in the Chemical Component Dictionary. Similar counts are reported in the Torsion and Rings columns. '-' means no outliers of that kind were identified.

Mol	Type	Chain	Res	Link	Chirals	Torsions	Rings
34	ATP	A	501	-	-	8/18/38/38	0/3/3/3
34	ATP	B	501	-	-	4/18/38/38	0/3/3/3
34	ATP	E	401	17	-	0/18/38/38	0/3/3/3

Continued on next page...

Continued from previous page...

Mol	Type	Chain	Res	Link	Chirals	Torsions	Rings
34	ATP	D	502	-	-	6/18/38/38	0/3/3/3
34	ATP	D	501	16	-	0/18/38/38	0/3/3/3

All (5) bond length outliers are listed below:

Mol	Chain	Res	Type	Atoms	Z	Observed(Å)	Ideal(Å)
34	A	501	ATP	PG-O1G	13.80	1.95	1.50
34	D	502	ATP	PG-O1G	13.79	1.95	1.50
34	B	501	ATP	C5-C4	2.49	1.47	1.40
34	D	501	ATP	C5-C4	2.15	1.46	1.40
34	E	401	ATP	C5-C4	2.13	1.46	1.40

The worst 5 of 25 bond angle outliers are listed below:

Mol	Chain	Res	Type	Atoms	Z	Observed(°)	Ideal(°)
34	D	502	ATP	PB-O3B-PG	-5.64	113.47	132.83
34	D	501	ATP	PA-O3A-PB	-5.58	113.68	132.83
34	E	401	ATP	PA-O3A-PB	-5.57	113.70	132.83
34	D	502	ATP	PA-O3A-PB	-5.53	113.86	132.83
34	A	501	ATP	PB-O3B-PG	-5.42	114.22	132.83

There are no chirality outliers.

5 of 18 torsion outliers are listed below:

Mol	Chain	Res	Type	Atoms
34	A	501	ATP	C5'-O5'-PA-O1A
34	A	501	ATP	C5'-O5'-PA-O2A
34	B	501	ATP	C5'-O5'-PA-O3A
34	B	501	ATP	C4'-C5'-O5'-PA
34	D	502	ATP	C5'-O5'-PA-O1A

There are no ring outliers.

No monomer is involved in short contacts.

The following is a two-dimensional graphical depiction of Mogul quality analysis of bond lengths, bond angles, torsion angles, and ring geometry for all instances of the Ligand of Interest. In addition, ligands with molecular weight > 250 and outliers as shown on the validation Tables will also be included. For torsion angles, if less than 5% of the Mogul distribution of torsion angles is within 10 degrees of the torsion angle in question, then that torsion angle is considered an outlier. Any bond that is central to one or more torsion angles identified as an outlier by Mogul will be highlighted in the graph. For rings, the root-mean-square deviation (RMSD) between the ring in question and similar rings identified by Mogul is calculated over all ring torsion angles. If the

average RMSD is greater than 60 degrees and the minimal RMSD between the ring in question and any Mogul-identified rings is also greater than 60 degrees, then that ring is considered an outlier. The outliers are highlighted in purple. The color gray indicates Mogul did not find sufficient equivalents in the CSD to analyse the geometry.

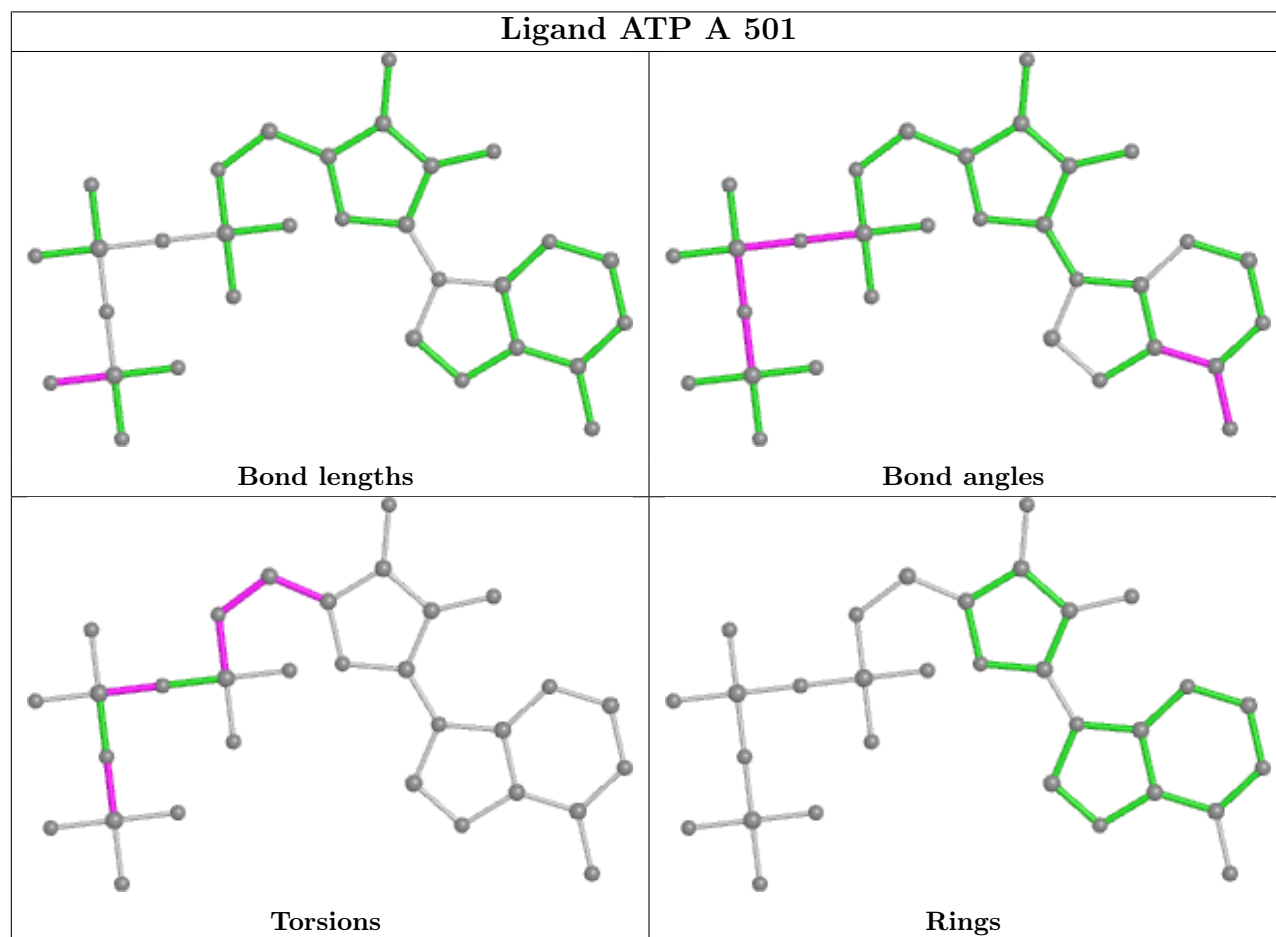

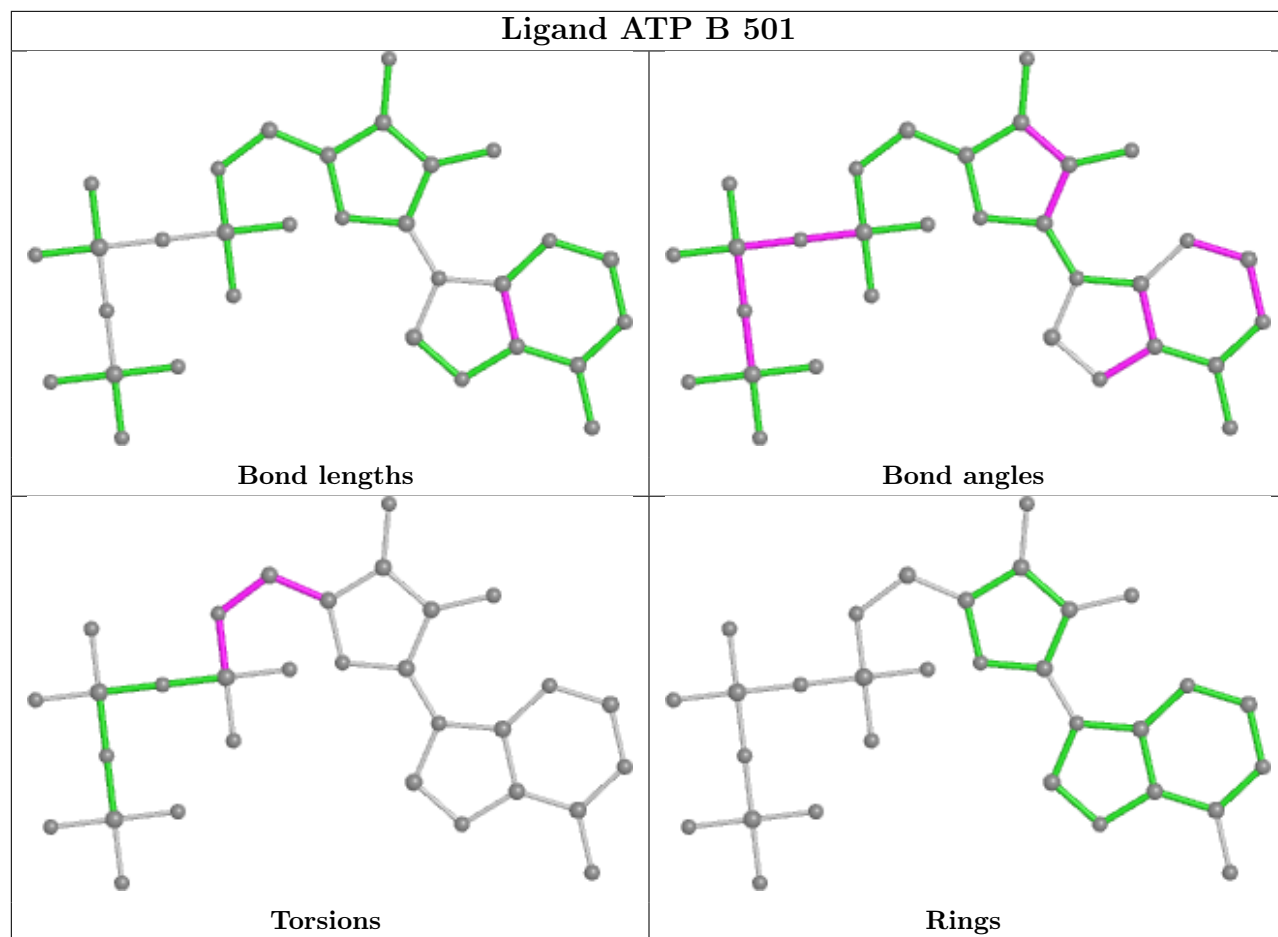

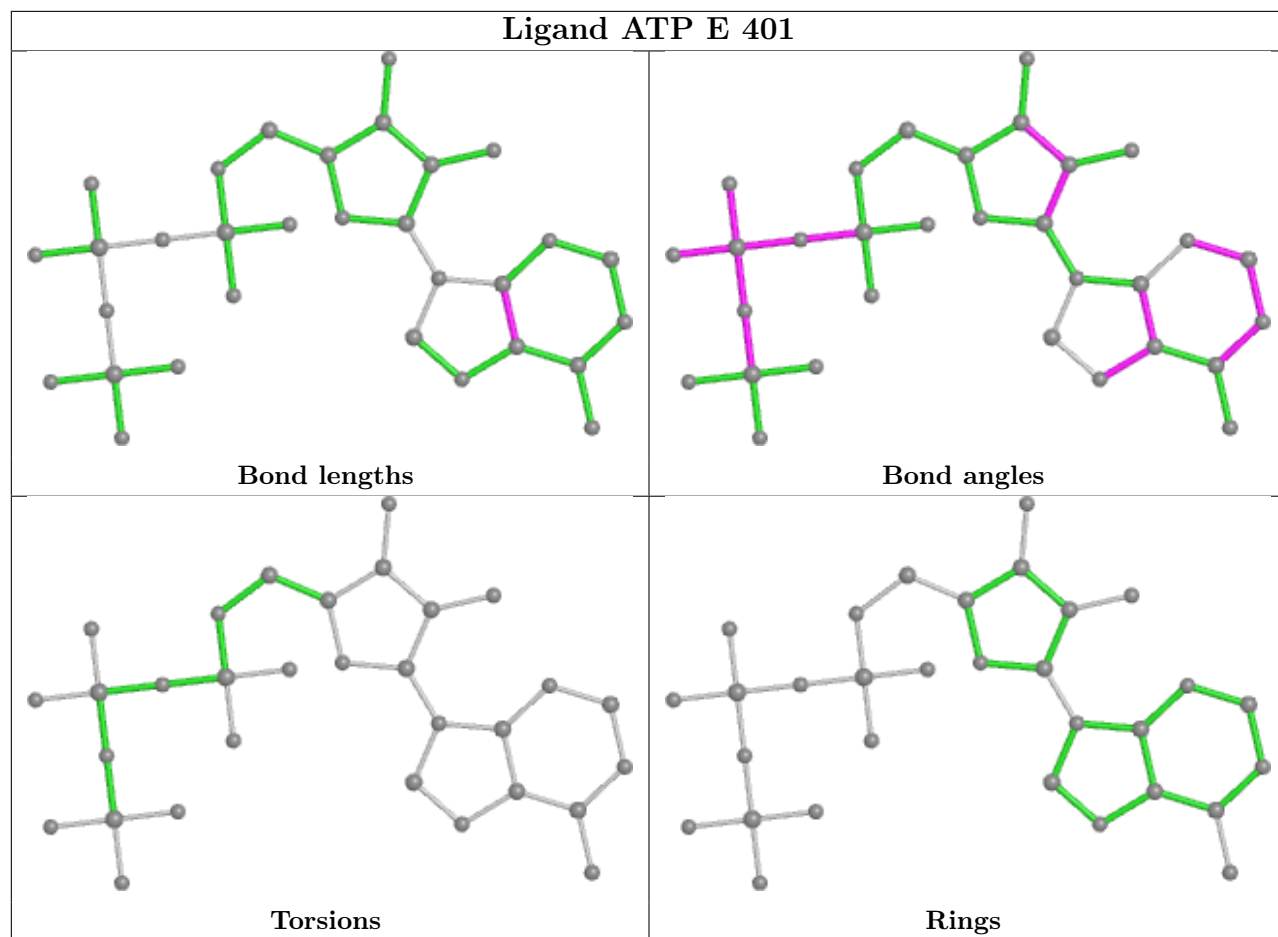

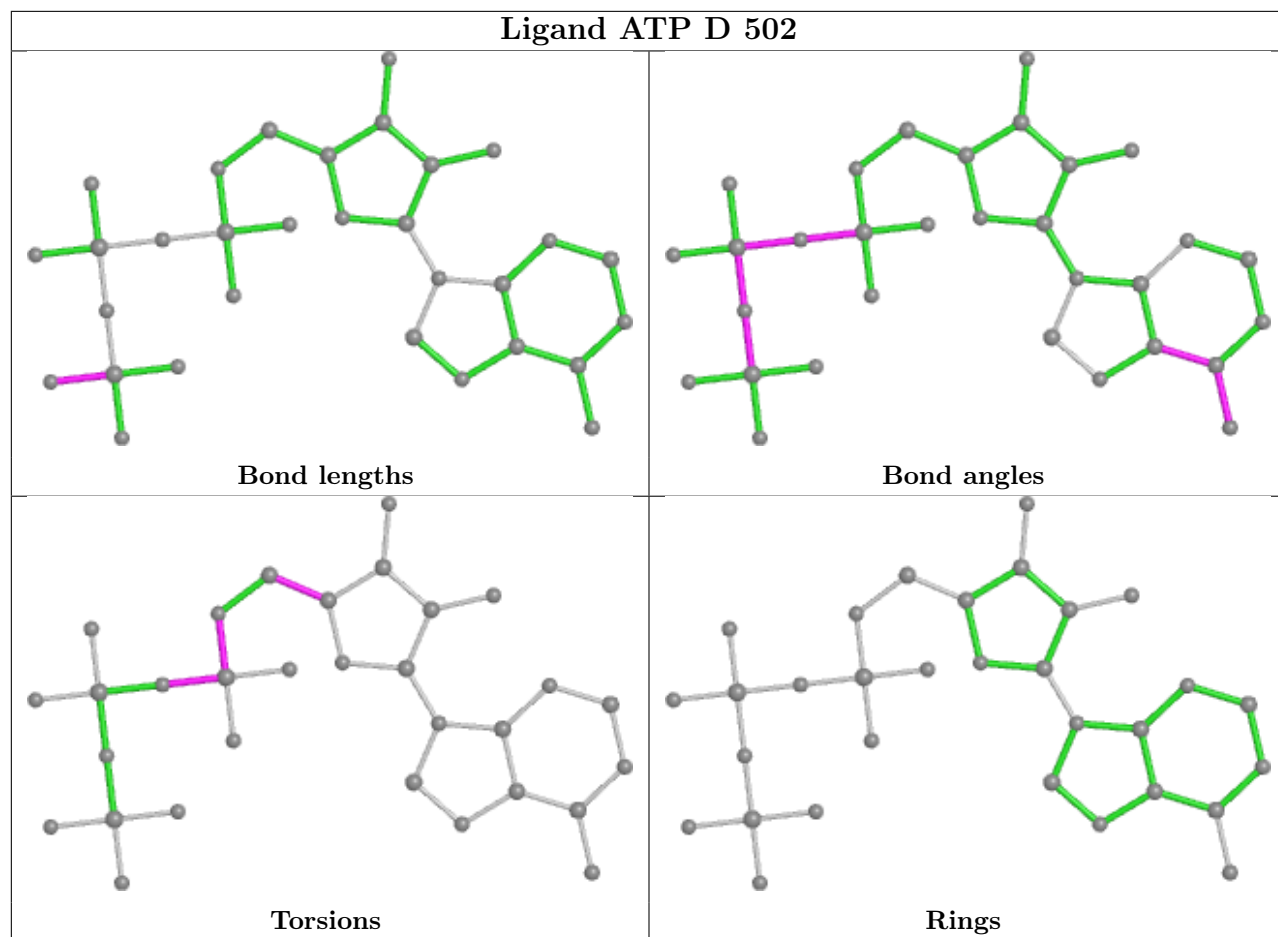

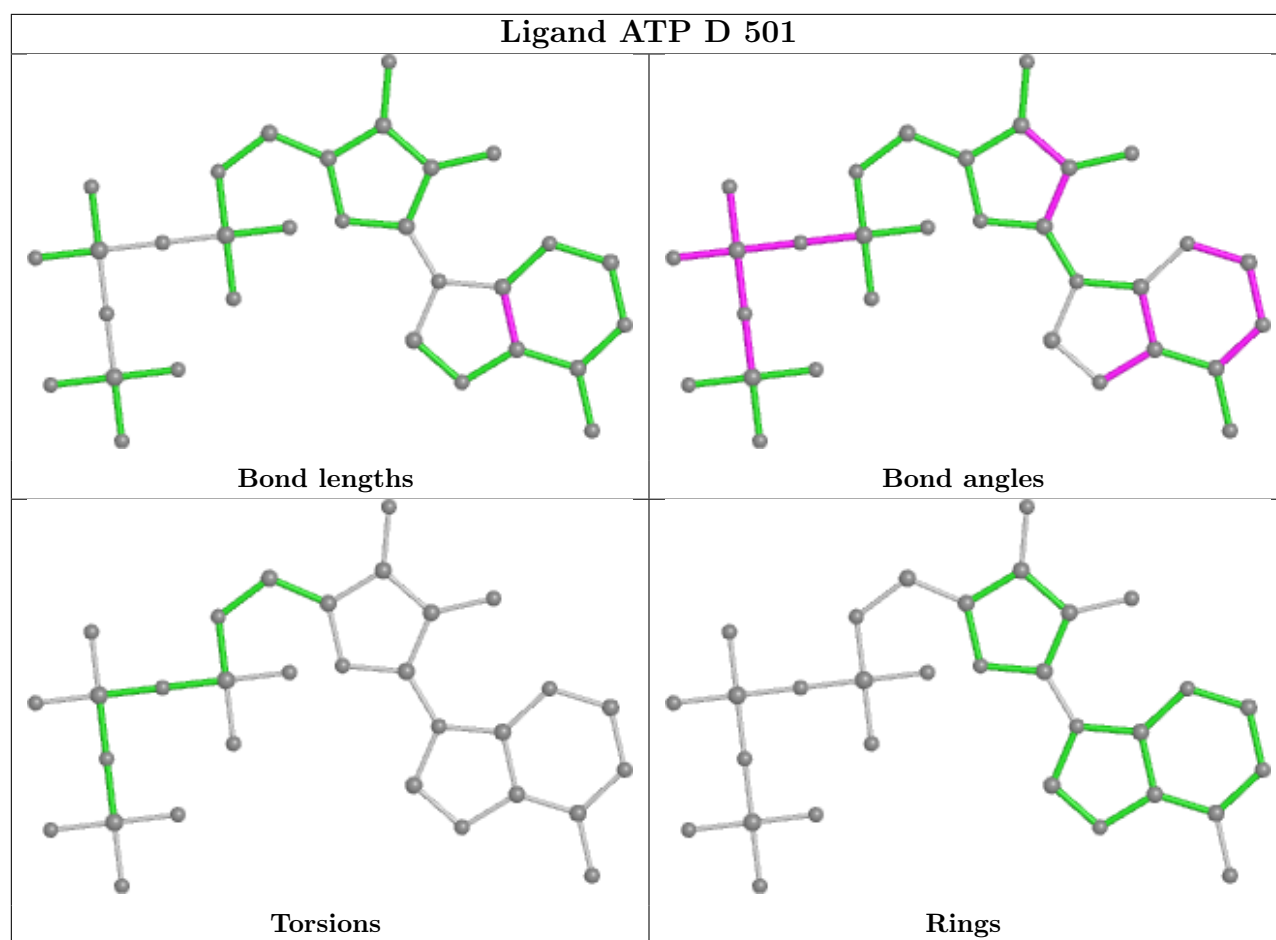

5.7 Other polymers [i](#)

There are no such residues in this entry.

5.8 Polymer linkage issues [i](#)

There are no chain breaks in this entry.

6 Map visualisation [i](#)

This section contains visualisations of the EMDB entry EMD-14209. These allow visual inspection of the internal detail of the map and identification of artifacts.

No raw map or half-maps were deposited for this entry and therefore no images, graphs, etc. pertaining to the raw map can be shown.

6.1 Orthogonal projections [i](#)

6.1.1 Primary map

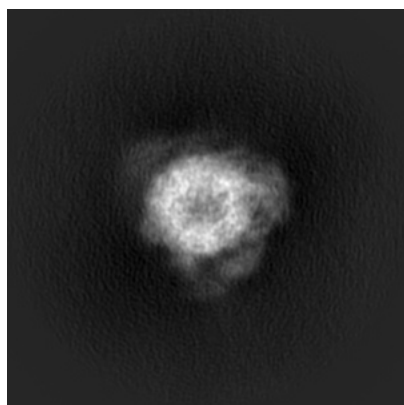

X

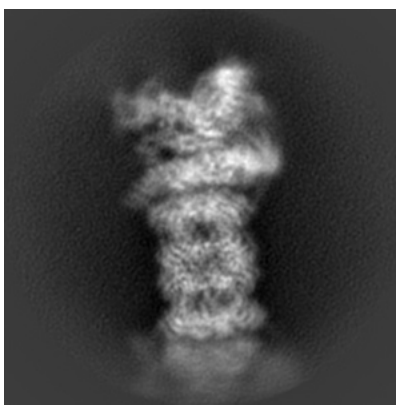

Y

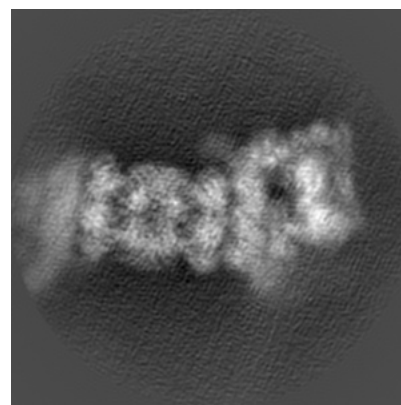

Z

The images above show the map projected in three orthogonal directions.

6.2 Central slices [i](#)

6.2.1 Primary map

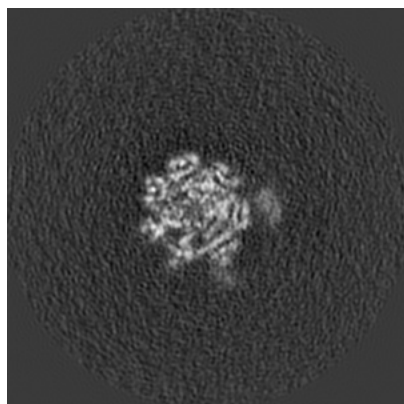

X Index: 160

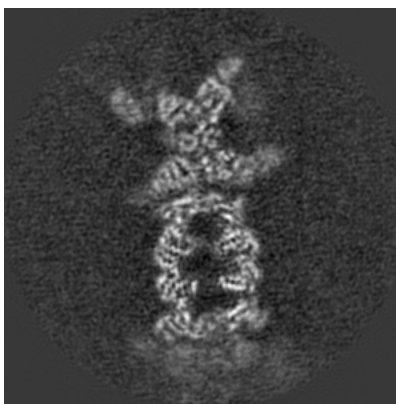

Y Index: 160

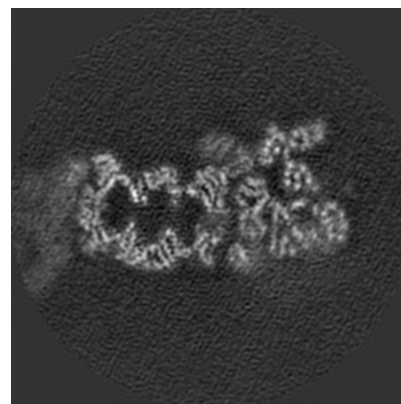

Z Index: 160

The images above show central slices of the map in three orthogonal directions.

6.3 Largest variance slices [i](#)

6.3.1 Primary map

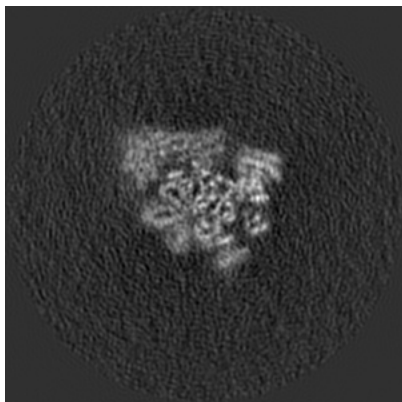

X Index: 195

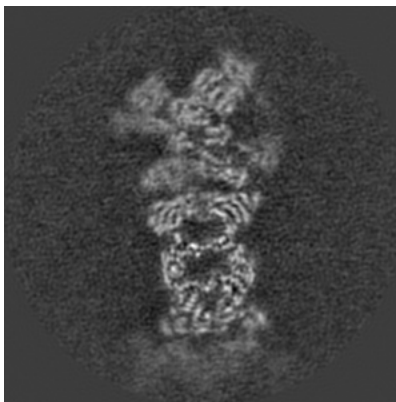

Y Index: 143

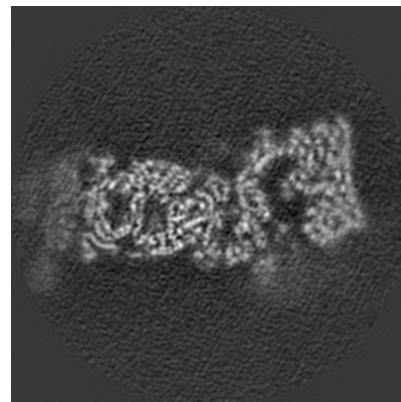

Z Index: 179

The images above show the largest variance slices of the map in three orthogonal directions.

6.4 Orthogonal surface views [i](#)

6.4.1 Primary map

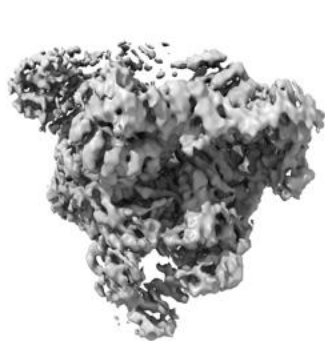

X



Y

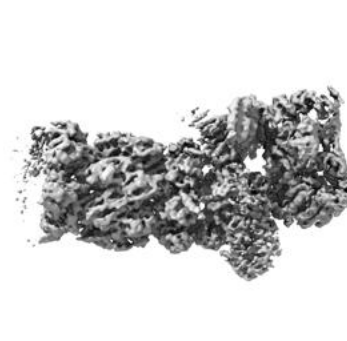

Z

The images above show the 3D surface view of the map at the recommended contour level 0.0315. These images, in conjunction with the slice images, may facilitate assessment of whether an appropriate contour level has been provided.

6.5 Mask visualisation

This section was not generated. No masks/segmentation were deposited.

7 Map analysis [i](#)

This section contains the results of statistical analysis of the map.

7.1 Map-value distribution [i](#)

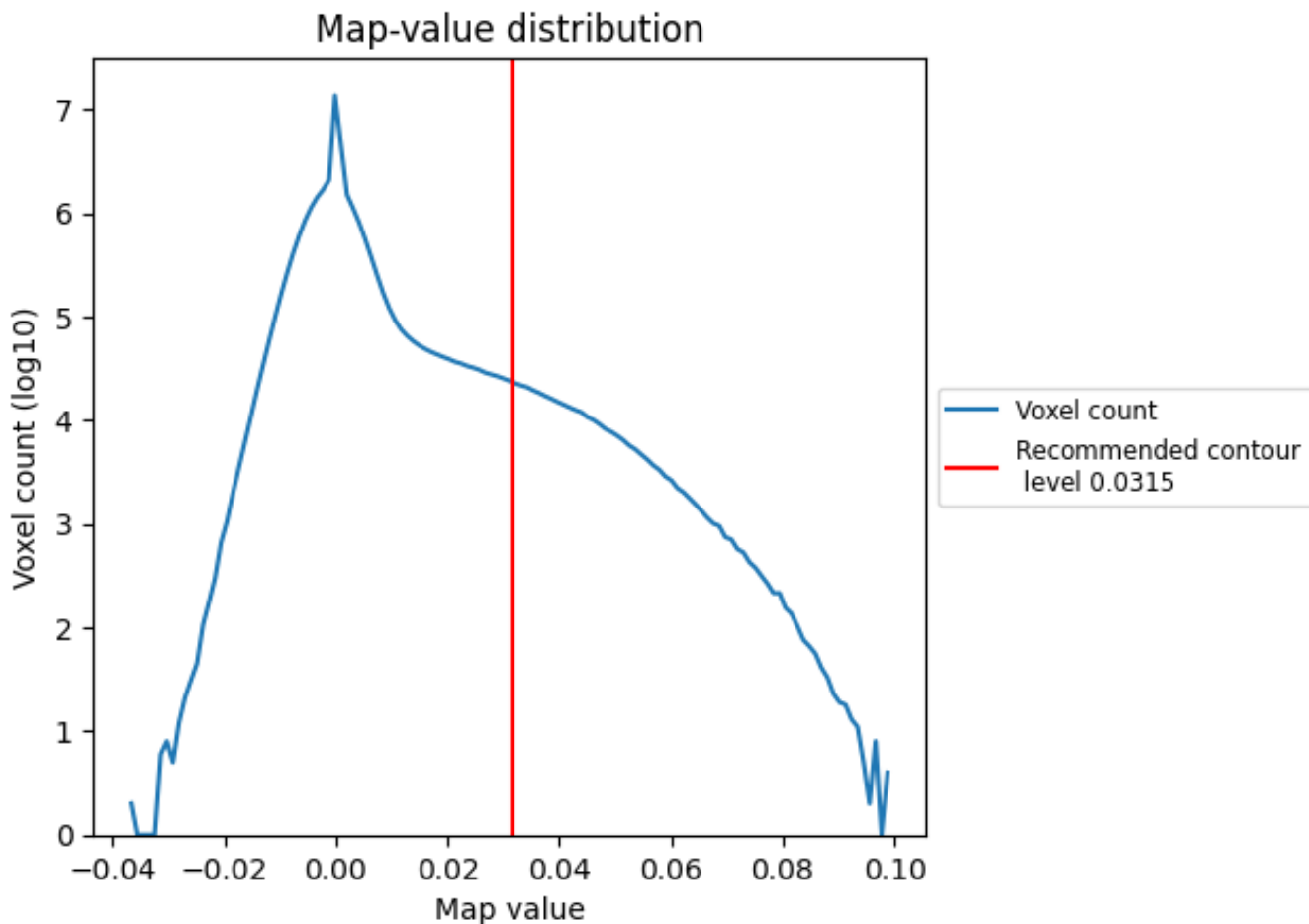

The map-value distribution is plotted in 128 intervals along the x-axis. The y-axis is logarithmic. A spike in this graph at zero usually indicates that the volume has been masked.

7.2 Volume estimate [\(i\)](#)

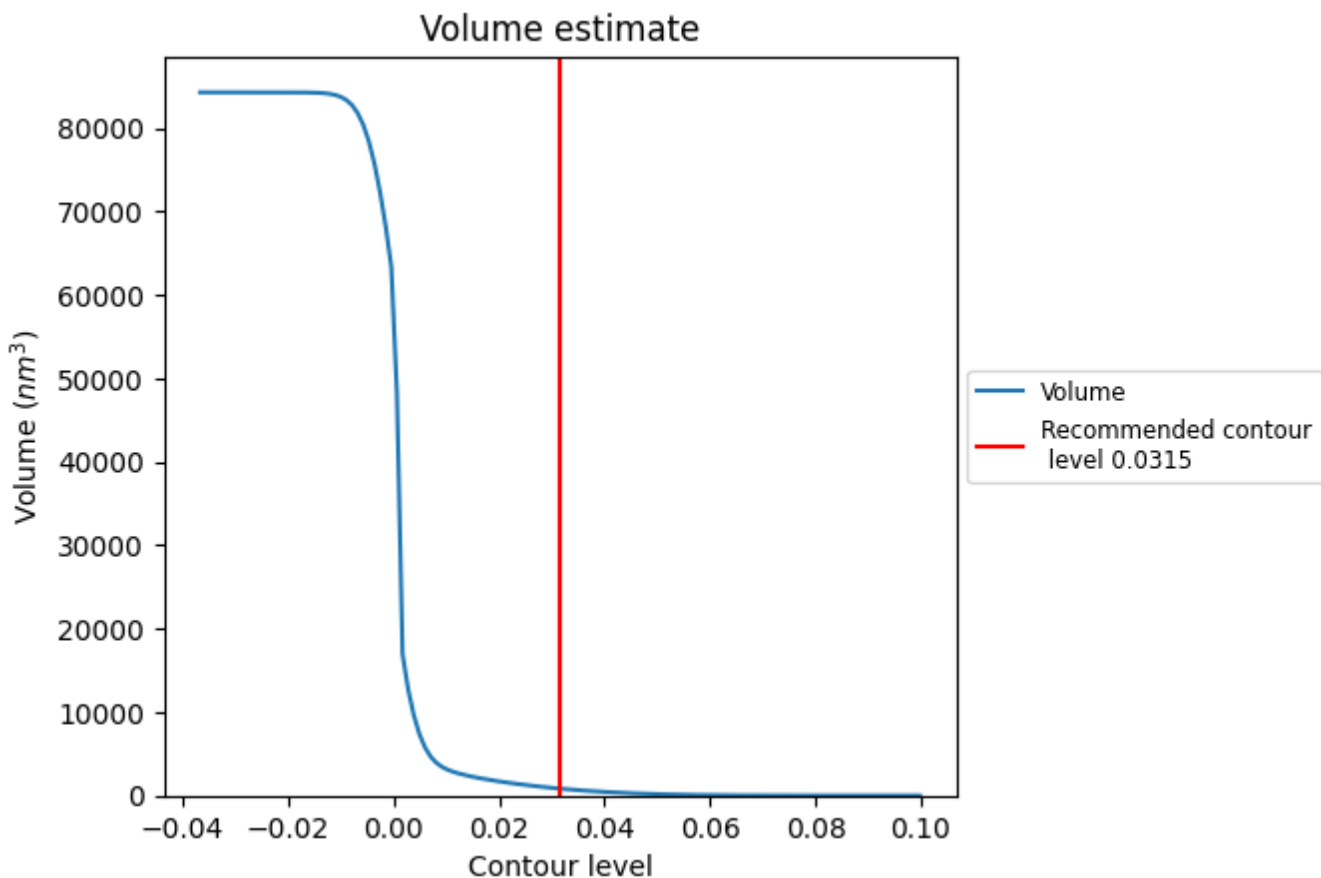

The volume at the recommended contour level is 836 nm^3 ; this corresponds to an approximate mass of 755 kDa.

The volume estimate graph shows how the enclosed volume varies with the contour level. The recommended contour level is shown as a vertical line and the intersection between the line and the curve gives the volume of the enclosed surface at the given level.

7.3 Rotationally averaged power spectrum [i](#)

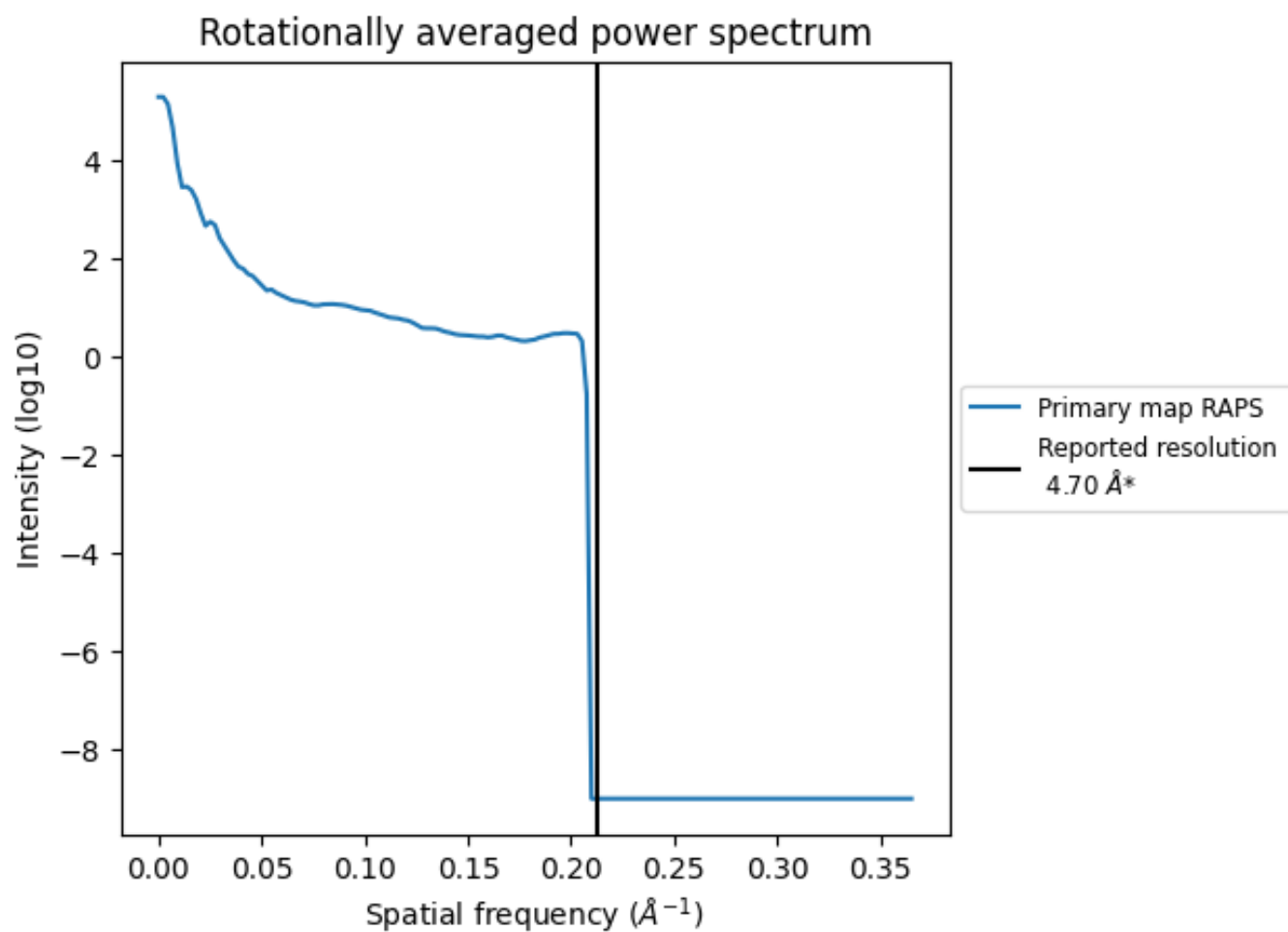

*Reported resolution corresponds to spatial frequency of 0.213 Å⁻¹

8 Fourier-Shell correlation

This section was not generated. No FSC curve or half-maps provided.

9 Map-model fit [i](#)

This section contains information regarding the fit between EMDB map EMD-14209 and PDB model 7QY7. Per-residue inclusion information can be found in section 3 on page 12.

9.1 Map-model overlay [i](#)

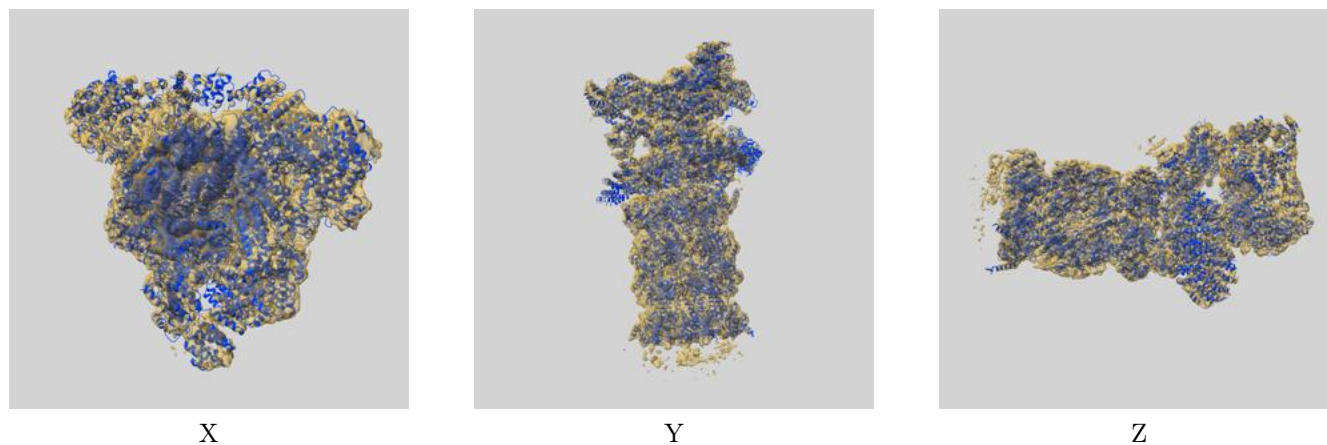

The images above show the 3D surface view of the map at the recommended contour level 0.0315 at 50% transparency in yellow overlaid with a ribbon representation of the model coloured in blue. These images allow for the visual assessment of the quality of fit between the atomic model and the map.

9.2 Q-score mapped to coordinate model [i](#)

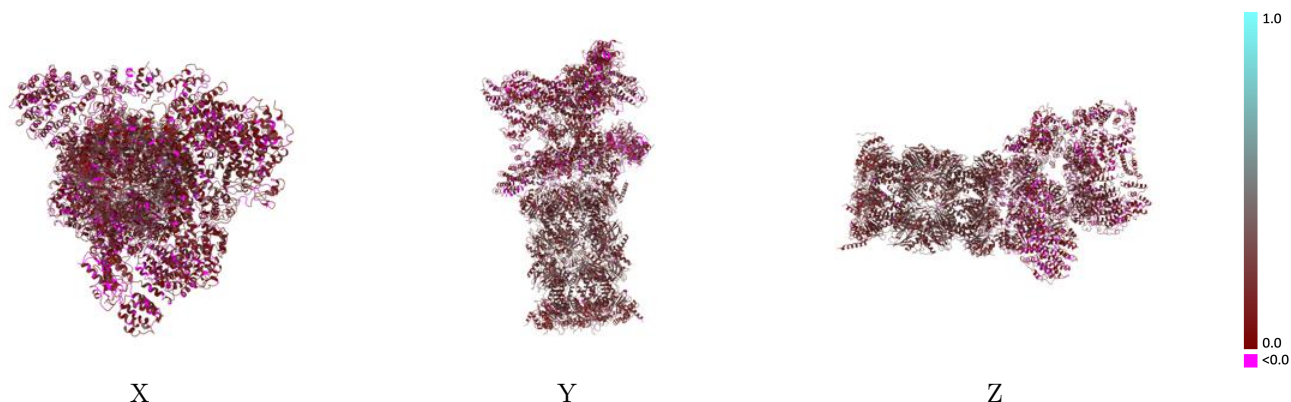

The images above show the model with each residue coloured according to its Q-score. This shows their resolvability in the map with higher Q-score values reflecting better resolvability. Please note: Q-score is calculating the resolvability of atoms, and thus high values are only expected at resolutions at which atoms can be resolved. Low Q-score values may therefore be expected for many entries.

9.3 Atom inclusion mapped to coordinate model [i](#)

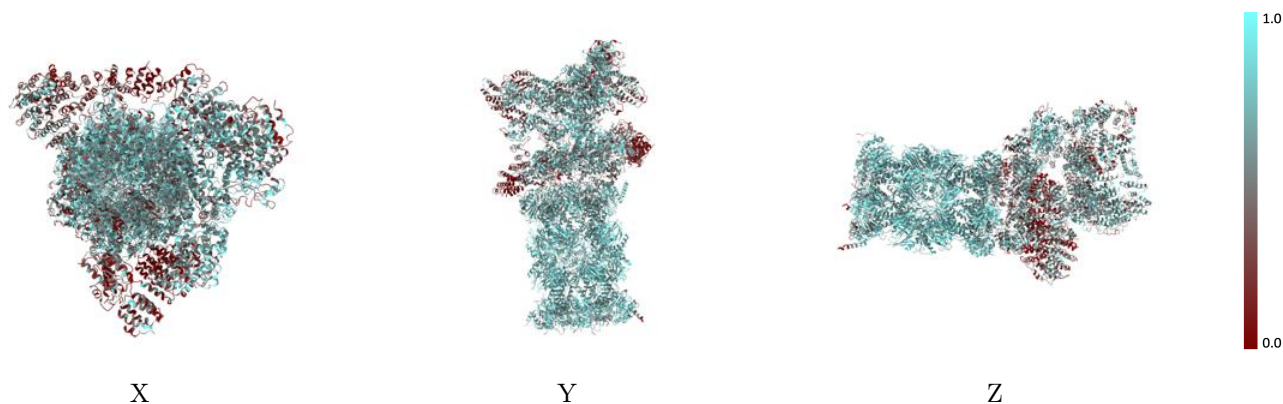

The images above show the model with each residue coloured according to its atom inclusion. This shows to what extent they are inside the map at the recommended contour level (0.0315).



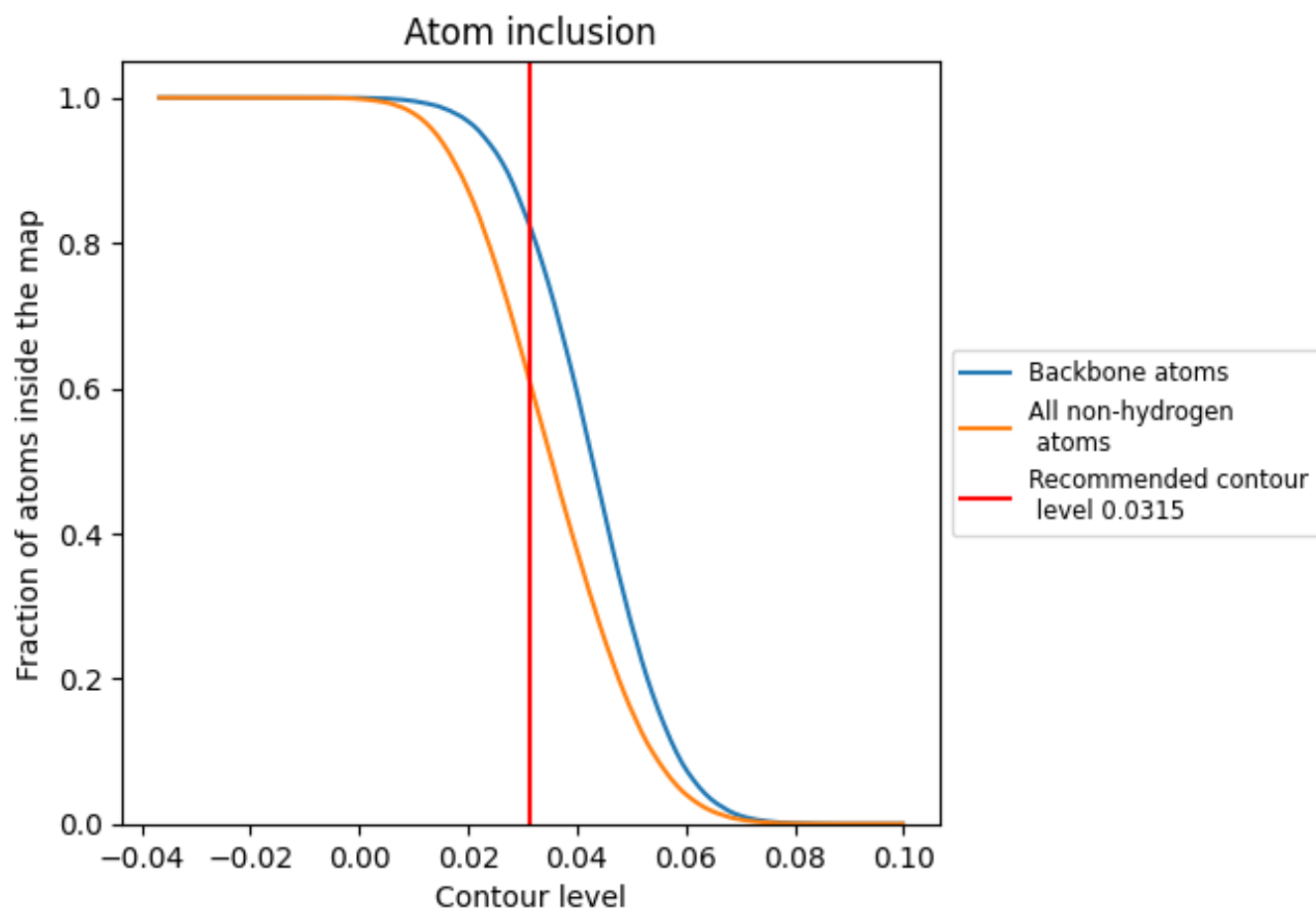



































































9.4 Atom inclusion [i](#)



At the recommended contour level, 82% of all backbone atoms, 61% of all non-hydrogen atoms, are inside the map.

9.5 Map-model fit summary

























The table lists the average atom inclusion at the recommended contour level (0.0315) and Q-score for the entire model and for each chain.

Chain	Atom inclusion	Q-score
All	 0.6052	 0.1930
A	 0.4996	 0.1350
B	 0.5445	 0.1790
C	 0.5913	 0.1820
D	 0.5837	 0.1730
E	 0.5046	 0.1660
F	 0.3825	 0.1110
G	 0.6799	 0.2080
H	 0.7006	 0.2230
I	 0.6482	 0.2160
J	 0.7251	 0.2430
K	 0.7033	 0.2340
L	 0.7272	 0.2330
M	 0.6918	 0.2100
N	 0.7775	 0.2590
O	 0.7646	 0.2670
P	 0.7330	 0.2540
Q	 0.7824	 0.2680
R	 0.8131	 0.2830
S	 0.7707	 0.2790
T	 0.7899	 0.2730
U	 0.6140	 0.1540
V	 0.4960	 0.1370
W	 0.3667	 0.1230
X	 0.5553	 0.1560
Y	 0.6661	 0.1610
Z	 0.5620	 0.1470
a	 0.4958	 0.1340
b	 0.3019	 0.1100
c	 0.5873	 0.1650
d	 0.4571	 0.1350
e	 0.3303	 0.0690
f	 0.2638	 0.1140
g	 0.6732	 0.2300
h	 0.6532	 0.2190



Continued on next page...

Continued from previous page...

Chain	Atom inclusion	Q-score
i	 0.6307	 0.2150
j	 0.6735	 0.2230
k	 0.6741	 0.2290
l	 0.7255	 0.2420
m	 0.7067	 0.2320
n	 0.7797	 0.2620
o	 0.7708	 0.2720
p	 0.7535	 0.2720
q	 0.7616	 0.2770
r	 0.7817	 0.2610
s	 0.7807	 0.2770
t	 0.7825	 0.2750