



Full wwPDB X-ray Structure Validation Report ⓘ

Jun 14, 2020 – 05:45 am BST

PDB ID : 1PMO
Title : Crystal structure of Escherichia coli GadB (neutral pH)
Authors : Capitani, G.; De Biase, D.; Aurizi, C.; Gut, H.; Bossa, F.; Grutter, M.G.
Deposited on : 2003-06-11
Resolution : 2.30 Å(reported)

This is a Full wwPDB X-ray Structure Validation Report for a publicly released PDB entry.

We welcome your comments at validation@mail.wwpdb.org

A user guide is available at

<https://www.wwpdb.org/validation/2017/XrayValidationReportHelp>

with specific help available everywhere you see the ⓘ symbol.

The following versions of software and data (see [references ⓘ](#)) were used in the production of this report:

MolProbity : 4.02b-467
Mogul : 1.8.5 (274361), CSD as541be (2020)
Xtriage (Phenix) : 1.13
EDS : 2.11
Percentile statistics : 20191225.v01 (using entries in the PDB archive December 25th 2019)
Refmac : 5.8.0158
CCP4 : 7.0.044 (Gargrove)
Ideal geometry (proteins) : Engh & Huber (2001)
Ideal geometry (DNA, RNA) : Parkinson et al. (1996)
Validation Pipeline (wwPDB-VP) : 2.11

1 Overall quality at a glance i

The following experimental techniques were used to determine the structure:

X-RAY DIFFRACTION

The reported resolution of this entry is 2.30 Å.

Percentile scores (ranging between 0-100) for global validation metrics of the entry are shown in the following graphic. The table shows the number of entries on which the scores are based.

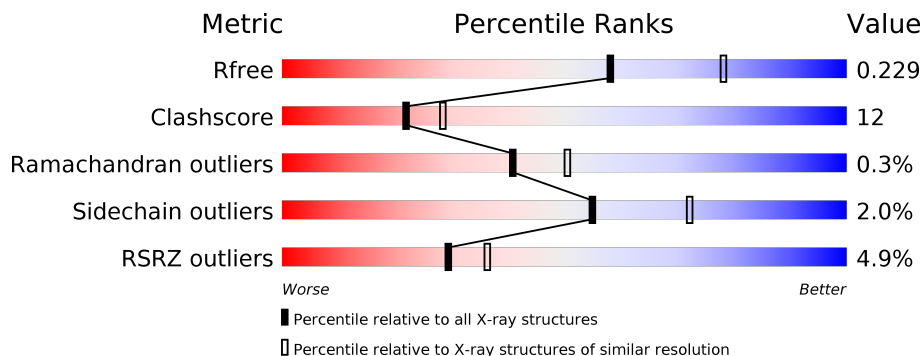

Metric	Whole archive (#Entries)	Similar resolution (#Entries, resolution range(Å))
R_{free}	130704	5042 (2.30-2.30)
Clashscore	141614	5643 (2.30-2.30)
Ramachandran outliers	138981	5575 (2.30-2.30)
Sidechain outliers	138945	5575 (2.30-2.30)
RSRZ outliers	127900	4938 (2.30-2.30)

The table below summarises the geometric issues observed across the polymeric chains and their fit to the electron density. The red, orange, yellow and green segments on the lower bar indicate the fraction of residues that contain outliers for ≥ 3 , 2, 1 and 0 types of geometric quality criteria respectively. A grey segment represents the fraction of residues that are not modelled. The numeric value for each fraction is indicated below the corresponding segment, with a dot representing fractions $\leq 5\%$. The upper red bar (where present) indicates the fraction of residues that have poor fit to the electron density. The numeric value is given above the bar.

Mol	Chain	Length	Quality of chain
1	A	466	<div style="display: flex; align-items: center;"> <div style="width: 5%; height: 10px; background-color: red; margin-right: 5px;"></div> <div style="width: 71%; height: 10px; background-color: green; margin-right: 5px;"></div> <div style="width: 26%; height: 10px; background-color: yellow; margin-right: 5px;"></div> <div style="width: 2%; height: 10px; background-color: grey; margin-right: 5px;"></div> <div style="width: 2%; height: 10px; background-color: grey;"></div> </div> <p style="text-align: center;">5% 71% 26% ..</p>
1	B	466	<div style="display: flex; align-items: center;"> <div style="width: 6%; height: 10px; background-color: red; margin-right: 5px;"></div> <div style="width: 74%; height: 10px; background-color: green; margin-right: 5px;"></div> <div style="width: 24%; height: 10px; background-color: yellow; margin-right: 5px;"></div> <div style="width: 2%; height: 10px; background-color: grey; margin-right: 5px;"></div> <div style="width: 2%; height: 10px; background-color: grey;"></div> </div> <p style="text-align: center;">6% 74% 24% ..</p>
1	C	466	<div style="display: flex; align-items: center;"> <div style="width: 4%; height: 10px; background-color: red; margin-right: 5px;"></div> <div style="width: 75%; height: 10px; background-color: green; margin-right: 5px;"></div> <div style="width: 22%; height: 10px; background-color: yellow; margin-right: 5px;"></div> <div style="width: 2%; height: 10px; background-color: grey; margin-right: 5px;"></div> <div style="width: 2%; height: 10px; background-color: grey;"></div> </div> <p style="text-align: center;">4% 75% 22% ..</p>
1	D	466	<div style="display: flex; align-items: center;"> <div style="width: 5%; height: 10px; background-color: red; margin-right: 5px;"></div> <div style="width: 75%; height: 10px; background-color: green; margin-right: 5px;"></div> <div style="width: 21%; height: 10px; background-color: yellow; margin-right: 5px;"></div> <div style="width: 2%; height: 10px; background-color: grey; margin-right: 5px;"></div> <div style="width: 2%; height: 10px; background-color: grey;"></div> </div> <p style="text-align: center;">5% 75% 21% ..</p>
1	E	466	<div style="display: flex; align-items: center;"> <div style="width: 5%; height: 10px; background-color: red; margin-right: 5px;"></div> <div style="width: 76%; height: 10px; background-color: green; margin-right: 5px;"></div> <div style="width: 22%; height: 10px; background-color: yellow; margin-right: 5px;"></div> <div style="width: 2%; height: 10px; background-color: grey; margin-right: 5px;"></div> <div style="width: 2%; height: 10px; background-color: grey;"></div> </div> <p style="text-align: center;">5% 76% 22% ..</p>
1	F	466	<div style="display: flex; align-items: center;"> <div style="width: 4%; height: 10px; background-color: red; margin-right: 5px;"></div> <div style="width: 79%; height: 10px; background-color: green; margin-right: 5px;"></div> <div style="width: 17%; height: 10px; background-color: yellow; margin-right: 5px;"></div> <div style="width: 2%; height: 10px; background-color: grey; margin-right: 5px;"></div> <div style="width: 2%; height: 10px; background-color: grey;"></div> </div> <p style="text-align: center;">4% 79% 17% ..</p>

The following table lists non-polymeric compounds, carbohydrate monomers and non-standard residues in protein, DNA, RNA chains that are outliers for geometric or electron-density-fit criteria:

Mol	Type	Chain	Res	Chirality	Geometry	Clashes	Electron density
3	TRS	A	3251	-	-	X	-
3	TRS	C	3250	-	-	X	-
3	TRS	C	3252	-	-	X	-
3	TRS	E	3246	-	-	X	-
3	TRS	F	3248	-	-	X	-

2 Entry composition [i](#)

There are 4 unique types of molecules in this entry. The entry contains 23202 atoms, of which 0 are hydrogens and 0 are deuteriums.

In the tables below, the ZeroOcc column contains the number of atoms modelled with zero occupancy, the AltConf column contains the number of residues with at least one atom in alternate conformation and the Trace column contains the number of residues modelled with at most 2 atoms.

- Molecule 1 is a protein called Glutamate decarboxylase beta.

Mol	Chain	Residues	Atoms					ZeroOcc	AltConf	Trace
			Total	C	N	O	S			
1	A	455	Total 3616	C 2308	N 617	O 667	S 24	0	0	0
1	B	463	Total 3681	C 2347	N 630	O 680	S 24	0	0	0
1	C	454	Total 3607	C 2303	N 616	O 664	S 24	0	0	0
1	D	454	Total 3607	C 2303	N 616	O 664	S 24	0	0	0
1	E	463	Total 3681	C 2347	N 630	O 680	S 24	0	0	0
1	F	454	Total 3607	C 2303	N 616	O 664	S 24	0	0	0

- Molecule 2 is (5-HYDROXY-4,6-DIMETHYLPYRIDIN-3-YL)METHYL DIHYDROGEN PHOSPHATE (three-letter code: PLR) (formula: C₈H₁₂NO₅P).

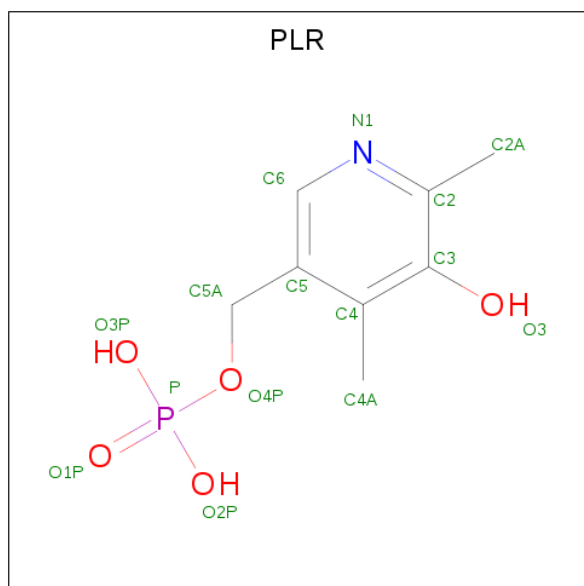

Mol	Chain	Residues	Atoms				ZeroOcc	AltConf	
			Total	C	N	O			P
2	A	1	Total 15	C 8	N 1	O 5	P 1	0	0
2	B	1	Total 15	C 8	N 1	O 5	P 1	0	0
2	C	1	Total 15	C 8	N 1	O 5	P 1	0	0
2	D	1	Total 15	C 8	N 1	O 5	P 1	0	0
2	E	1	Total 15	C 8	N 1	O 5	P 1	0	0
2	F	1	Total 15	C 8	N 1	O 5	P 1	0	0

- Molecule 3 is 2-AMINO-2-HYDROXYMETHYL-PROPANE-1,3-DIOL (three-letter code: TRS) (formula: C₄H₁₂NO₃).

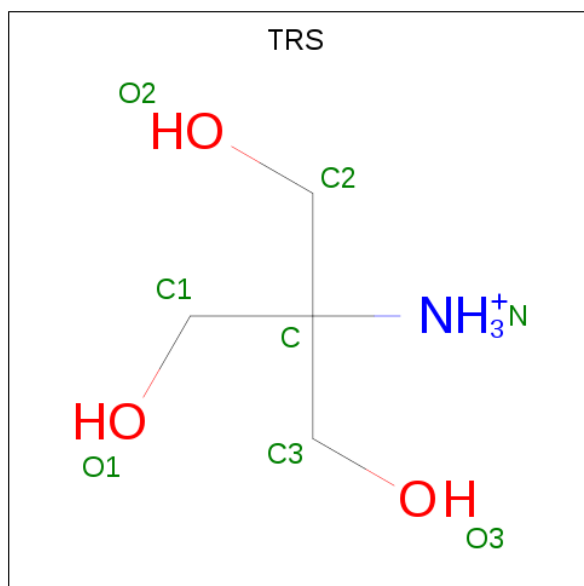

Mol	Chain	Residues	Atoms				ZeroOcc	AltConf
			Total	C	N	O		
3	A	1	Total 8	C 4	N 1	O 3	0	0
3	A	1	Total 8	C 4	N 1	O 3	0	0
3	A	1	Total 8	C 4	N 1	O 3	0	0
3	B	1	Total 8	C 4	N 1	O 3	0	0
3	B	1	Total 8	C 4	N 1	O 3	0	0

Continued on next page...

Continued from previous page...

Mol	Chain	Residues	Atoms				ZeroOcc	AltConf
3	C	1	Total	C	N	O	0	0
			8	4	1	3		
3	C	1	Total	C	N	O	0	0
			8	4	1	3		
3	C	1	Total	C	N	O	0	0
			8	4	1	3		
3	D	1	Total	C	N	O	0	0
			8	4	1	3		
3	D	1	Total	C	N	O	0	0
			8	4	1	3		
3	D	1	Total	C	N	O	0	0
			8	4	1	3		
3	E	1	Total	C	N	O	0	0
			8	4	1	3		
3	E	1	Total	C	N	O	0	0
			8	4	1	3		
3	E	1	Total	C	N	O	0	0
			8	4	1	3		
3	E	1	Total	C	N	O	0	0
			8	4	1	3		
3	F	1	Total	C	N	O	0	0
			8	4	1	3		
3	F	1	Total	C	N	O	0	0
			8	4	1	3		
3	F	1	Total	C	N	O	0	0
			8	4	1	3		

- Molecule 4 is water.

Mol	Chain	Residues	Atoms		ZeroOcc	AltConf
4	A	188	Total	O	0	0
			188	188		
4	B	190	Total	O	0	0
			190	190		
4	C	207	Total	O	0	0
			207	207		
4	D	187	Total	O	0	0
			187	187		
4	E	208	Total	O	0	0
			208	208		
4	F	189	Total	O	0	0
			189	189		

3 Residue-property plots [i](#)

These plots are drawn for all protein, RNA and DNA chains in the entry. The first graphic for a chain summarises the proportions of the various outlier classes displayed in the second graphic. The second graphic shows the sequence view annotated by issues in geometry and electron density. Residues are color-coded according to the number of geometric quality criteria for which they contain at least one outlier: green = 0, yellow = 1, orange = 2 and red = 3 or more. A red dot above a residue indicates a poor fit to the electron density ($RSRZ > 2$). Stretches of 2 or more consecutive residues without any outlier are shown as a green connector. Residues present in the sample, but not in the model, are shown in grey.

- Molecule 1: Glutamate decarboxylase beta

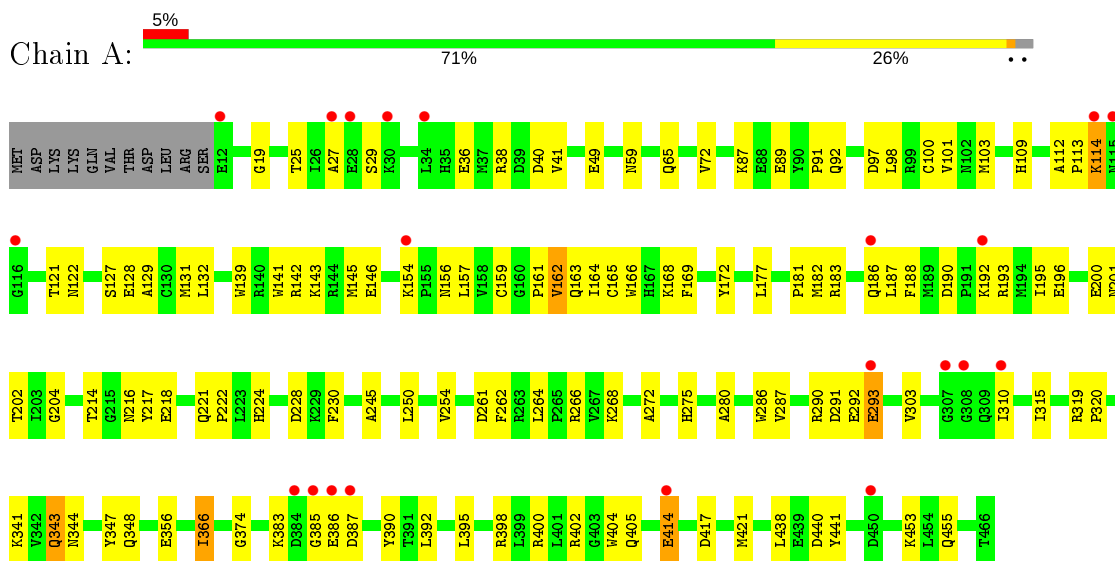

- Molecule 1: Glutamate decarboxylase beta

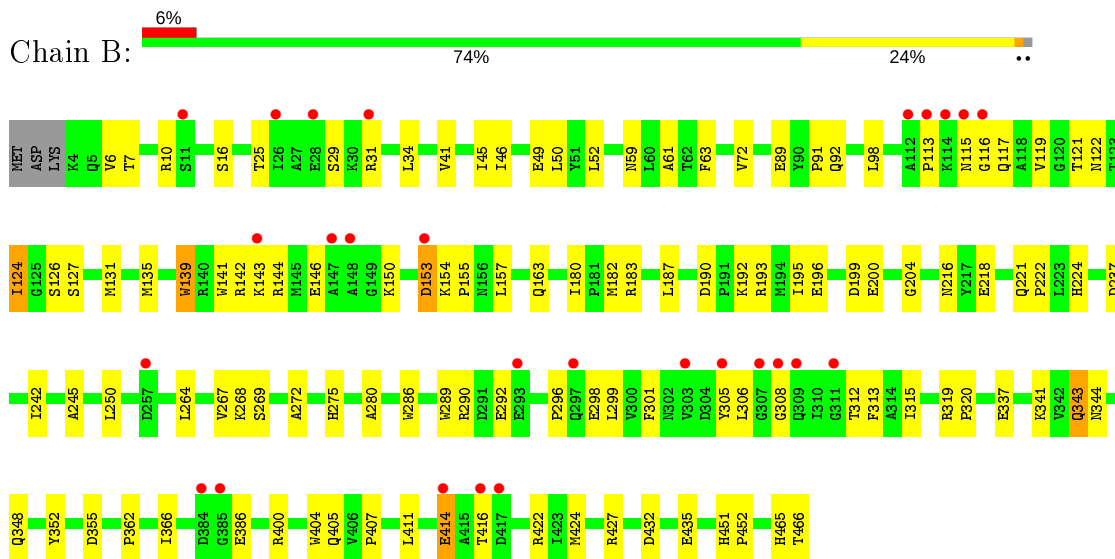

- Molecule 1: Glutamate decarboxylase beta

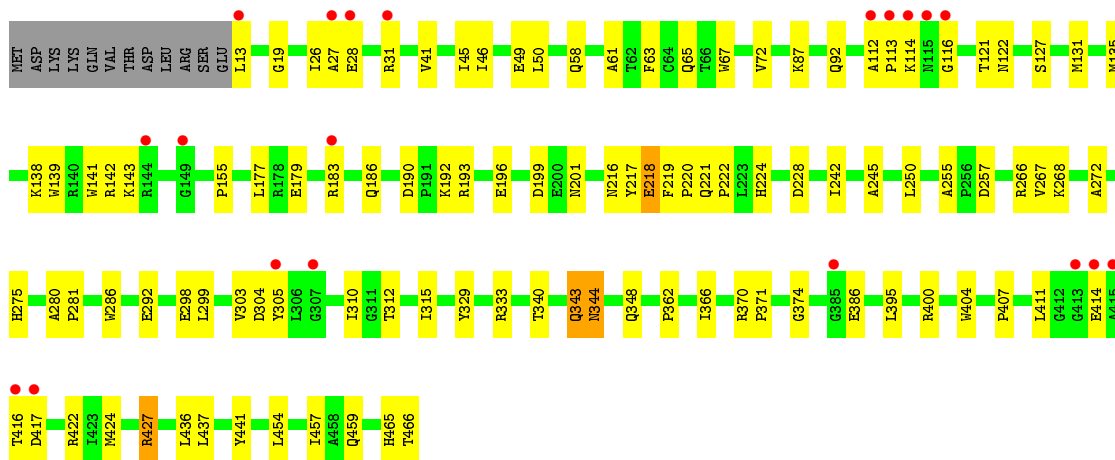
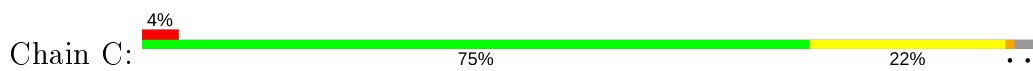

• Molecule 1: Glutamate decarboxylase beta

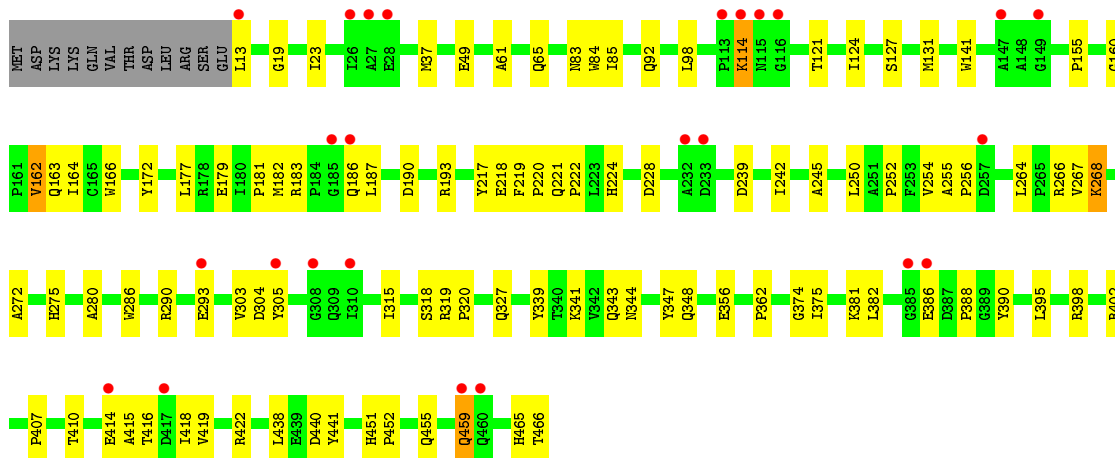
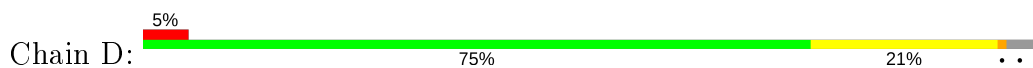

• Molecule 1: Glutamate decarboxylase beta

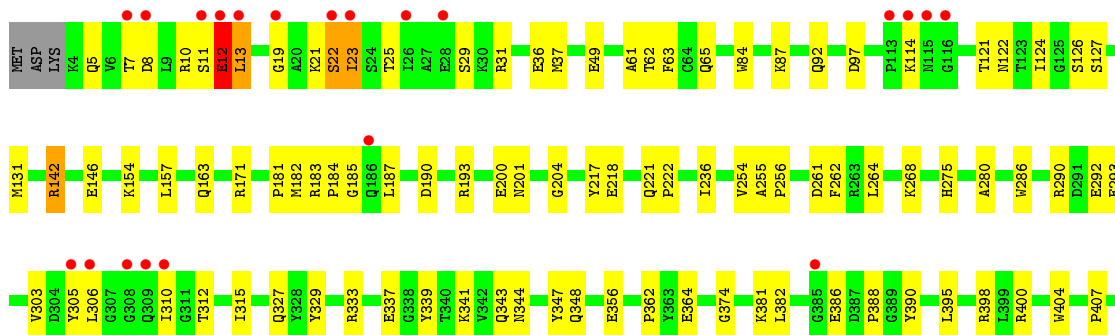
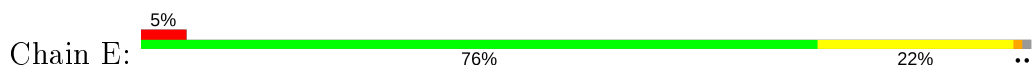



- Molecule 1: Glutamate decarboxylase beta

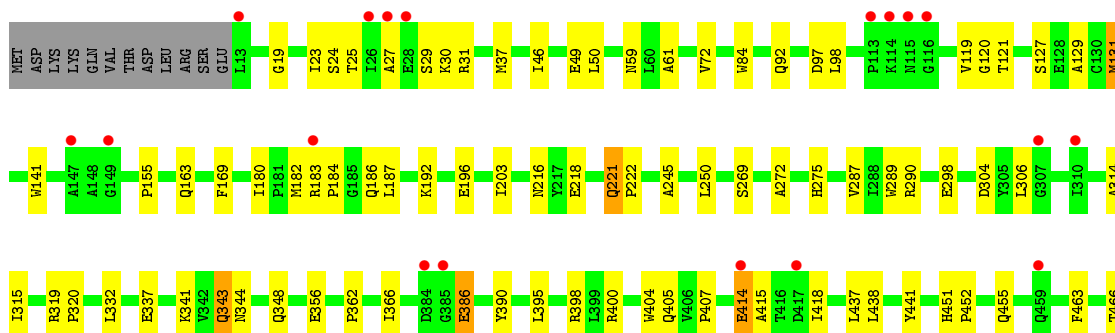
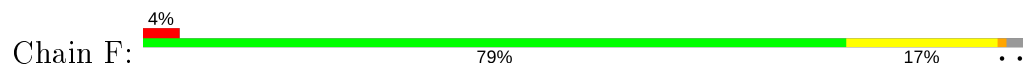

4 Data and refinement statistics

Property	Value	Source
Space group	P 32	Depositor
Cell constants a, b, c, α , β , γ	116.00Å 116.00Å 207.35Å 90.00° 90.00° 120.00°	Depositor
Resolution (Å)	20.00 – 2.30 20.00 – 2.30	Depositor EDS
% Data completeness (in resolution range)	98.9 (20.00-2.30) 98.9 (20.00-2.30)	Depositor EDS
R_{merge}	0.10	Depositor
R_{sym}	(Not available)	Depositor
$\langle I/\sigma(I) \rangle$ ¹	2.32 (at 2.30Å)	Xtriage
Refinement program	CNS	Depositor
R, R_{free}	0.200 , 0.233 0.196 , 0.229	Depositor DCC
R_{free} test set	2749 reflections (2.02%)	wwPDB-VP
Wilson B-factor (Å ²)	26.7	Xtriage
Anisotropy	0.079	Xtriage
Bulk solvent k_{sol} (e/Å ³), B_{sol} (Å ²)	0.40 , 54.8	EDS
L-test for twinning ²	$\langle L \rangle = 0.50$, $\langle L^2 \rangle = 0.33$	Xtriage
Estimated twinning fraction	0.003 for -h,-k,l 0.025 for h,-h-k,-l 0.016 for -k,-h,-l	Xtriage
F_o, F_c correlation	0.94	EDS
Total number of atoms	23202	wwPDB-VP
Average B, all atoms (Å ²)	28.0	wwPDB-VP

Xtriage's analysis on translational NCS is as follows: *The largest off-origin peak in the Patterson function is 4.84% of the height of the origin peak. No significant pseudotranslation is detected.*

¹Intensities estimated from amplitudes.

²Theoretical values of $\langle |L| \rangle$, $\langle L^2 \rangle$ for acentric reflections are 0.5, 0.333 respectively for untwinned datasets, and 0.375, 0.2 for perfectly twinned datasets.

5 Model quality

5.1 Standard geometry

Bond lengths and bond angles in the following residue types are not validated in this section: TRS, PLR

The Z score for a bond length (or angle) is the number of standard deviations the observed value is removed from the expected value. A bond length (or angle) with $|Z| > 5$ is considered an outlier worth inspection. RMSZ is the root-mean-square of all Z scores of the bond lengths (or angles).

Mol	Chain	Bond lengths		Bond angles	
		RMSZ	# Z >5	RMSZ	# Z >5
1	A	0.37	0/3710	0.61	1/5028 (0.0%)
1	B	0.36	0/3775	0.60	1/5115 (0.0%)
1	C	0.38	0/3701	0.60	1/5016 (0.0%)
1	D	0.36	0/3701	0.60	1/5016 (0.0%)
1	E	0.36	0/3775	0.61	1/5115 (0.0%)
1	F	0.38	0/3701	0.60	1/5016 (0.0%)
All	All	0.37	0/22363	0.60	6/30306 (0.0%)

There are no bond length outliers.

All (6) bond angle outliers are listed below:

Mol	Chain	Res	Type	Atoms	Z	Observed(°)	Ideal(°)
1	D	218	GLU	N-CA-C	-5.37	96.49	111.00
1	F	218	GLU	N-CA-C	-5.36	96.53	111.00
1	C	218	GLU	N-CA-C	-5.29	96.70	111.00
1	B	218	GLU	N-CA-C	-5.26	96.78	111.00
1	E	218	GLU	N-CA-C	-5.24	96.86	111.00
1	A	218	GLU	N-CA-C	-5.14	97.12	111.00

There are no chirality outliers.

There are no planarity outliers.

5.2 Too-close contacts

In the following table, the Non-H and H(model) columns list the number of non-hydrogen atoms and hydrogen atoms in the chain respectively. The H(added) column lists the number of hydrogen atoms added and optimized by MolProbity. The Clashes column lists the number of clashes within the asymmetric unit, whereas Symm-Clashes lists symmetry related clashes.

Mol	Chain	Non-H	H(model)	H(added)	Clashes	Symm-Clashes
1	A	3616	0	3516	114	0
1	B	3681	0	3586	84	0
1	C	3607	0	3510	87	0
1	D	3607	0	3510	83	0
1	E	3681	0	3586	97	0
1	F	3607	0	3510	76	0
2	A	15	0	9	0	0
2	B	15	0	9	1	0
2	C	15	0	9	1	0
2	D	15	0	9	0	0
2	E	15	0	9	0	0
2	F	15	0	9	1	0
3	A	24	0	36	12	0
3	B	16	0	24	7	0
3	C	24	0	36	18	0
3	D	24	0	36	9	0
3	E	32	0	48	14	0
3	F	24	0	36	17	0
4	A	188	0	0	7	0
4	B	190	0	0	2	0
4	C	207	0	0	5	0
4	D	187	0	0	6	0
4	E	208	0	0	5	0
4	F	189	0	0	5	0
All	All	23202	0	21488	512	0

The all-atom clashscore is defined as the number of clashes found per 1000 atoms (including hydrogen atoms). The all-atom clashscore for this structure is 12.

All (512) close contacts within the same asymmetric unit are listed below, sorted by their clash magnitude.

Atom-1	Atom-2	Interatomic distance (Å)	Clash overlap (Å)
1:A:65:GLN:HB3	3:A:3236:TRS:H31	1.20	1.11
1:F:250:LEU:HD23	1:F:343:GLN:HG3	1.42	1.01
1:A:250:LEU:HD23	1:A:343:GLN:HG3	1.44	0.98
1:B:250:LEU:HD23	1:B:343:GLN:HG3	1.46	0.97
1:C:436:LEU:HD11	3:C:3252:TRS:H21	1.47	0.96
1:A:183:ARG:HG2	1:A:414:GLU:HB2	1.47	0.94
1:F:72:VAL:HG21	3:F:3240:TRS:H12	1.54	0.88
1:B:190:ASP:OD1	1:B:193:ARG:HD3	1.76	0.85
1:D:121:THR:OG1	3:D:3244:TRS:H11	1.76	0.85
1:C:250:LEU:HD23	1:C:343:GLN:HG3	1.57	0.84

Continued on next page...

Continued from previous page...

Atom-1	Atom-2	Interatomic distance (Å)	Clash overlap (Å)
1:C:183:ARG:HD2	1:C:186:GLN:HE21	1.40	0.84
1:B:183:ARG:HG2	1:B:414:GLU:HB2	1.59	0.84
1:A:91:PRO:HB2	3:C:3252:TRS:H12	1.60	0.82
1:C:281:PRO:HB3	3:C:3250:TRS:H22	1.62	0.82
1:C:362:PRO:HB2	1:C:386:GLU:HG2	1.64	0.81
1:E:49:GLU:O	1:F:92:GLN:HG2	1.83	0.79
1:E:427:ARG:HH21	3:E:3239:TRS:H12	1.47	0.78
1:A:114:LYS:HD2	1:A:114:LYS:H	1.49	0.78
1:D:190:ASP:OD1	1:D:193:ARG:HD3	1.82	0.78
1:A:190:ASP:OD1	1:A:193:ARG:HD3	1.84	0.77
1:D:114:LYS:HD2	1:D:114:LYS:H	1.48	0.77
1:A:65:GLN:HB3	3:A:3236:TRS:C3	2.09	0.77
1:C:72:VAL:HG11	3:C:3250:TRS:H12	1.66	0.77
1:D:362:PRO:HB2	1:D:386:GLU:HG2	1.67	0.77
1:D:65:GLN:HB3	3:D:3238:TRS:N	2.00	0.76
1:E:92:GLN:HG2	1:F:49:GLU:O	1.87	0.74
1:D:221:GLN:HB3	1:D:222:PRO:HD3	1.69	0.74
1:E:362:PRO:HB2	1:E:386:GLU:HG2	1.70	0.73
1:E:411:LEU:O	1:E:416:THR:HA	1.89	0.73
1:C:183:ARG:HB2	1:C:186:GLN:HG3	1.69	0.73
1:E:127:SER:O	1:E:131:MET:HG2	1.88	0.73
1:E:5:GLN:HG3	1:E:10:ARG:HD2	1.70	0.73
1:A:214:THR:CG2	1:A:366:ILE:HD11	2.18	0.73
1:F:183:ARG:HE	1:F:414:GLU:HG2	1.54	0.73
1:E:427:ARG:NH2	3:E:3239:TRS:H12	2.04	0.72
1:A:221:GLN:HB3	1:A:222:PRO:HD3	1.70	0.72
1:C:183:ARG:HD2	1:C:186:GLN:NE2	2.02	0.72
1:B:341:LYS:HE2	1:C:19:GLY:O	1.88	0.72
1:B:124:ILE:CD1	1:B:319:ARG:HD2	2.19	0.72
1:D:390:TYR:HA	1:D:455:GLN:HG3	1.72	0.72
1:C:114:LYS:HZ2	1:C:292:GLU:HG2	1.55	0.71
1:F:356:GLU:HG2	1:F:438:LEU:HD13	1.71	0.71
1:A:65:GLN:CB	3:A:3236:TRS:H31	2.11	0.71
1:C:121:THR:HA	3:C:3243:TRS:H12	1.72	0.71
1:E:190:ASP:OD1	1:E:193:ARG:HD3	1.91	0.71
1:A:91:PRO:CB	3:C:3252:TRS:H12	2.20	0.71
1:D:242:ILE:HD11	1:D:267:VAL:HG22	1.73	0.71
1:E:7:THR:HA	1:E:10:ARG:HD3	1.71	0.71
1:E:315:ILE:HG21	1:F:315:ILE:HD13	1.73	0.70
1:D:65:GLN:HB3	3:D:3238:TRS:HN2	1.56	0.70
1:E:183:ARG:HH21	1:E:414:GLU:HG2	1.56	0.70

Continued on next page...

Continued from previous page...

Atom-1	Atom-2	Interatomic distance (Å)	Clash overlap (Å)
1:D:84:TRP:HZ2	3:D:3244:TRS:H12	1.57	0.69
1:A:341:LYS:HE2	1:F:19:GLY:O	1.91	0.69
1:F:121:THR:OG1	3:F:3248:TRS:H31	1.92	0.69
1:E:364:GLU:OE1	1:E:381:LYS:HE3	1.93	0.68
1:B:362:PRO:HB2	1:B:386:GLU:HG2	1.75	0.68
1:F:127:SER:O	1:F:131:MET:HG2	1.94	0.68
1:F:72:VAL:HG21	3:F:3240:TRS:C1	2.24	0.68
1:F:250:LEU:CD2	1:F:343:GLN:HG3	2.22	0.68
1:C:92:GLN:HG2	1:D:49:GLU:O	1.93	0.68
1:A:164:ILE:HD12	1:A:165:CYS:N	2.07	0.67
1:D:422:ARG:HD2	4:D:3284:HOH:O	1.95	0.67
1:C:49:GLU:O	1:D:92:GLN:HG2	1.94	0.67
1:A:291:ASP:OD1	1:A:293:GLU:HG2	1.95	0.67
1:D:19:GLY:O	1:E:341:LYS:HE2	1.95	0.66
1:C:242:ILE:HD13	1:C:267:VAL:HG13	1.77	0.66
1:F:183:ARG:HG3	1:F:184:PRO:HD2	1.78	0.66
1:D:84:TRP:CZ2	3:D:3244:TRS:H12	2.31	0.66
1:A:162:VAL:HG22	1:A:166:TRP:CD1	2.30	0.66
1:A:114:LYS:HE2	1:A:292:GLU:HG2	1.77	0.66
1:A:214:THR:HB	1:A:366:ILE:HD11	1.77	0.65
1:B:250:LEU:HD23	1:B:343:GLN:CG	2.23	0.65
1:D:303:VAL:HG23	1:D:305:TYR:CE1	2.31	0.65
1:E:200:GLU:CD	1:E:200:GLU:H	1.97	0.65
1:C:138:LYS:O	1:C:142:ARG:HG3	1.95	0.65
1:A:127:SER:O	1:A:131:MET:HG2	1.96	0.65
1:A:214:THR:HG21	1:A:366:ILE:HD11	1.79	0.65
1:A:214:THR:CB	1:A:366:ILE:HD11	2.27	0.65
1:C:250:LEU:CD2	1:C:343:GLN:HG3	2.25	0.65
1:E:398:ARG:HD3	4:E:3343:HOH:O	1.97	0.64
1:A:87:LYS:HG2	1:A:310:ILE:HD13	1.80	0.64
1:D:183:ARG:HG2	1:D:414:GLU:HB3	1.80	0.64
1:F:120:GLY:H	3:F:3249:TRS:H32	1.63	0.64
1:A:392:LEU:HD13	1:A:421:MET:HB2	1.80	0.63
1:C:422:ARG:HG2	4:C:3329:HOH:O	1.98	0.63
1:D:339:TYR:O	1:D:343:GLN:HG2	1.98	0.63
1:A:100:CYS:HA	1:A:103:MET:HE3	1.81	0.63
1:F:119:VAL:HG13	3:F:3249:TRS:H31	1.80	0.63
1:A:383:LYS:HB2	1:A:386:GLU:HG3	1.80	0.63
1:A:356:GLU:HG2	1:A:438:LEU:HD13	1.81	0.63
1:A:49:GLU:O	1:B:92:GLN:HG2	1.98	0.63
1:E:121:THR:OG1	3:E:3246:TRS:H11	1.99	0.63

Continued on next page...

Continued from previous page...

Atom-1	Atom-2	Interatomic distance (Å)	Clash overlap (Å)
1:A:192:LYS:O	1:A:196:GLU:HG3	1.99	0.62
1:C:190:ASP:OD1	1:C:193:ARG:HD3	1.99	0.62
1:B:31:ARG:NH1	1:B:34:LEU:HD11	2.15	0.62
1:E:221:GLN:HB3	1:E:222:PRO:HD3	1.81	0.62
1:D:415:ALA:HB1	1:D:418:ILE:HD12	1.82	0.62
1:C:192:LYS:O	1:C:196:GLU:HG3	1.99	0.62
1:C:121:THR:HA	3:C:3243:TRS:C1	2.30	0.62
1:E:131:MET:CE	1:F:315:ILE:HG23	2.30	0.62
1:E:10:ARG:HE	1:E:12:GLU:HB3	1.63	0.61
1:F:192:LYS:O	1:F:196:GLU:HG3	1.98	0.61
1:F:390:TYR:HA	1:F:455:GLN:HG3	1.82	0.61
3:E:3246:TRS:O2	3:E:3246:TRS:O1	2.16	0.61
1:B:143:LYS:HE3	1:B:298:GLU:OE1	2.00	0.61
1:E:131:MET:HE3	1:F:315:ILE:HG23	1.83	0.61
1:A:182:MET:HG3	1:A:187:LEU:O	2.01	0.60
1:A:92:GLN:HG2	1:B:49:GLU:O	2.01	0.60
1:B:216:ASN:HD21	1:B:366:ILE:HG22	1.65	0.60
1:B:250:LEU:CD2	1:B:343:GLN:HG3	2.27	0.60
1:E:87:LYS:HG2	1:E:310:ILE:HD12	1.82	0.60
1:A:142:ARG:O	1:A:146:GLU:HG3	2.01	0.60
1:B:221:GLN:HB3	1:B:222:PRO:HD3	1.84	0.60
1:F:72:VAL:HG11	3:F:3240:TRS:H22	1.82	0.60
1:B:305:TYR:HB2	1:B:308:GLY:O	2.01	0.60
1:B:200:GLU:H	1:B:200:GLU:CD	2.05	0.59
1:E:183:ARG:HG2	1:E:414:GLU:HB2	1.82	0.59
1:C:362:PRO:CB	1:C:386:GLU:HG2	2.30	0.59
1:D:162:VAL:HG11	1:D:166:TRP:HB2	1.84	0.59
1:D:341:LYS:HE2	1:E:19:GLY:O	2.02	0.59
1:D:362:PRO:CB	1:D:386:GLU:HG2	2.32	0.59
1:A:250:LEU:CD2	1:A:343:GLN:HG3	2.27	0.59
1:C:114:LYS:NZ	1:C:292:GLU:HG2	2.17	0.59
1:E:142:ARG:O	1:E:146:GLU:HG3	2.02	0.59
1:F:183:ARG:HD2	1:F:186:GLN:HE21	1.66	0.59
1:F:131:MET:CE	1:F:169:PHE:HB2	2.33	0.59
1:F:84:TRP:HZ2	3:F:3248:TRS:H32	1.67	0.59
1:A:250:LEU:HD23	1:A:343:GLN:CG	2.27	0.59
1:E:381:LYS:HD2	1:E:418:ILE:HG23	1.84	0.59
1:A:181:PRO:O	1:A:193:ARG:NH2	2.36	0.59
1:A:87:LYS:HG2	1:A:310:ILE:CD1	2.32	0.59
1:C:135:MET:HE1	1:D:172:TYR:CD1	2.38	0.59
1:A:114:LYS:CD	1:A:114:LYS:H	2.15	0.58

Continued on next page...

Continued from previous page...

Atom-1	Atom-2	Interatomic distance (Å)	Clash overlap (Å)
1:A:101:VAL:HG21	3:A:3251:TRS:H12	1.84	0.58
1:E:84:TRP:HZ2	3:E:3246:TRS:H12	1.67	0.58
1:E:339:TYR:O	1:E:343:GLN:HG2	2.02	0.58
1:C:127:SER:O	1:C:131:MET:HG2	2.03	0.58
1:B:127:SER:O	1:B:131:MET:HG2	2.04	0.57
1:D:162:VAL:CG1	1:D:166:TRP:HB2	2.34	0.57
1:A:172:TYR:CD1	1:B:135:MET:HE1	2.39	0.57
1:C:121:THR:CA	3:C:3243:TRS:H12	2.35	0.57
1:D:114:LYS:CD	1:D:114:LYS:H	2.15	0.57
1:A:27:ALA:HA	4:A:3382:HOH:O	2.04	0.57
1:C:303:VAL:HG23	1:C:305:TYR:CE1	2.40	0.57
1:A:121:THR:HG1	3:A:3251:TRS:H21	1.70	0.57
1:C:221:GLN:HB3	1:C:222:PRO:HD3	1.87	0.57
1:D:356:GLU:HG2	1:D:438:LEU:HD13	1.86	0.57
1:E:293:GLU:HG3	4:E:3369:HOH:O	2.04	0.57
1:D:13:LEU:HD12	1:D:13:LEU:N	2.20	0.56
1:E:181:PRO:O	1:E:193:ARG:NH2	2.32	0.56
1:A:121:THR:OG1	3:A:3251:TRS:H21	2.05	0.56
1:E:183:ARG:HE	1:E:414:GLU:HB2	1.69	0.56
1:E:254:VAL:HG21	1:E:347:TYR:CE2	2.41	0.56
1:E:22:SER:OG	1:E:23:ILE:N	2.37	0.56
1:B:362:PRO:CB	1:B:386:GLU:HG2	2.36	0.56
1:F:398:ARG:HD3	4:F:3330:HOH:O	2.06	0.56
1:A:92:GLN:NE2	1:A:92:GLN:HA	2.21	0.56
1:E:182:MET:HG2	1:E:187:LEU:O	2.05	0.56
1:B:144:ARG:NH1	1:B:237:ASP:O	2.37	0.56
1:B:199:ASP:HB2	1:B:200:GLU:OE2	2.06	0.56
1:B:6:VAL:HA	1:C:257:ASP:HB2	1.89	0.55
1:C:411:LEU:O	1:C:416:THR:HA	2.06	0.55
1:B:25:THR:O	1:B:29:SER:HB3	2.06	0.55
1:C:114:LYS:NZ	1:C:292:GLU:H	2.04	0.55
1:C:250:LEU:HD23	1:C:343:GLN:CG	2.35	0.54
1:A:395:LEU:HD21	1:A:441:TYR:CZ	2.43	0.54
1:D:293:GLU:HG3	4:D:3371:HOH:O	2.07	0.54
1:B:121:THR:HA	3:B:3242:TRS:C1	2.37	0.54
1:C:422:ARG:HG2	1:C:422:ARG:HH11	1.72	0.54
1:B:124:ILE:HD13	1:B:319:ARG:HD2	1.90	0.54
1:D:13:LEU:N	4:D:3293:HOH:O	2.41	0.54
1:D:162:VAL:HG22	1:D:166:TRP:CD1	2.43	0.54
1:A:183:ARG:HG2	1:A:414:GLU:CB	2.30	0.54
1:D:242:ILE:HD13	1:D:267:VAL:HG13	1.89	0.54

Continued on next page...

Continued from previous page...

Atom-1	Atom-2	Interatomic distance (Å)	Clash overlap (Å)
1:D:402:ARG:HD2	1:D:440:ASP:OD1	2.08	0.54
1:D:362:PRO:CG	1:D:388:PRO:HG3	2.37	0.53
1:C:65:GLN:HG3	3:C:3250:TRS:N	2.23	0.53
1:C:87:LYS:HG2	1:C:310:ILE:HD12	1.88	0.53
1:C:333:ARG:HH21	1:C:427:ARG:HH22	1.57	0.53
1:F:290:ARG:HD3	4:F:3329:HOH:O	2.08	0.53
1:A:141:TRP:O	1:A:145:MET:HG2	2.08	0.53
1:C:298:GLU:CD	1:C:298:GLU:H	2.12	0.53
1:E:84:TRP:CZ2	3:E:3246:TRS:H12	2.44	0.53
1:F:141:TRP:CZ3	1:F:155:PRO:HB3	2.44	0.53
1:D:228:ASP:HA	1:D:266:ARG:HH21	1.73	0.53
1:E:11:SER:O	1:E:22:SER:HB2	2.09	0.53
1:F:121:THR:CB	3:F:3248:TRS:H31	2.39	0.53
1:F:415:ALA:HB1	1:F:418:ILE:HD12	1.90	0.53
1:A:164:ILE:HD13	1:A:168:LYS:HE3	1.90	0.53
1:E:184:PRO:HA	3:E:3253:TRS:H12	1.91	0.53
1:A:97:ASP:OD2	3:A:3251:TRS:H11	2.09	0.52
1:B:224:HIS:CD2	1:B:264:LEU:HB3	2.43	0.52
1:C:121:THR:CB	3:C:3243:TRS:H12	2.39	0.52
1:C:344:ASN:O	1:C:348:GLN:HG3	2.09	0.52
1:D:362:PRO:HG3	1:D:388:PRO:HG3	1.91	0.52
1:E:10:ARG:HG3	1:E:12:GLU:HG3	1.92	0.52
1:E:344:ASN:O	1:E:348:GLN:HG3	2.10	0.52
1:C:216:ASN:HD21	1:C:366:ILE:HG22	1.75	0.52
1:D:127:SER:O	1:D:131:MET:HG2	2.10	0.52
1:B:121:THR:OG1	3:B:3242:TRS:H12	2.10	0.52
1:C:242:ILE:HD11	1:C:267:VAL:HG22	1.92	0.52
1:E:36:GLU:HG3	1:F:337:GLU:HG2	1.92	0.52
1:C:343:GLN:HA	1:C:343:GLN:OE1	2.09	0.51
1:E:183:ARG:HE	1:E:414:GLU:CB	2.23	0.51
1:F:84:TRP:CZ2	3:F:3248:TRS:H32	2.45	0.51
1:A:162:VAL:CG1	1:A:166:TRP:HB2	2.40	0.51
1:E:163:GLN:HG2	4:E:3307:HOH:O	2.10	0.51
1:E:312:THR:HG22	3:E:3246:TRS:O3	2.11	0.51
1:E:65:GLN:HB3	3:E:3239:TRS:O1	2.11	0.51
1:F:183:ARG:NE	1:F:414:GLU:HG2	2.24	0.51
1:B:122:ASN:HB2	1:B:286:TRP:CZ3	2.46	0.51
1:A:38:ARG:HH21	1:A:40:ASP:HB2	1.76	0.51
3:E:3239:TRS:H21	4:E:3380:HOH:O	2.10	0.51
1:F:141:TRP:CD2	1:F:203:ILE:HG22	2.45	0.51
1:C:281:PRO:HD3	3:C:3250:TRS:O1	2.10	0.51

Continued on next page...

Continued from previous page...

Atom-1	Atom-2	Interatomic distance (Å)	Clash overlap (Å)
1:E:415:ALA:HB1	1:E:418:ILE:HD12	1.93	0.51
1:B:344:ASN:O	1:B:348:GLN:HG3	2.11	0.50
1:F:97:ASP:OD2	3:F:3248:TRS:O3	2.23	0.50
1:F:356:GLU:HG2	1:F:438:LEU:CD1	2.41	0.50
3:D:3238:TRS:O3	3:D:3238:TRS:O1	2.16	0.50
1:F:120:GLY:N	3:F:3249:TRS:H32	2.26	0.50
1:A:224:HIS:CD2	1:A:264:LEU:HB3	2.47	0.50
1:A:25:THR:O	1:A:29:SER:HB3	2.11	0.50
2:C:1502:PLR:O2P	1:D:318:SER:HB2	2.11	0.50
1:F:245:ALA:HA	1:F:272:ALA:HA	1.93	0.50
1:A:400:ARG:CZ	1:B:306:LEU:HD21	2.42	0.50
1:D:183:ARG:HG2	1:D:414:GLU:CB	2.42	0.50
1:A:38:ARG:HB2	1:A:41:VAL:HG23	1.93	0.50
1:B:192:LYS:O	1:B:196:GLU:HG3	2.12	0.50
1:A:177:LEU:C	1:A:177:LEU:HD13	2.32	0.49
1:B:41:VAL:O	1:B:45:ILE:HG13	2.12	0.49
1:E:329:TYR:CZ	1:E:333:ARG:HD3	2.47	0.49
1:A:38:ARG:HB2	1:A:41:VAL:CG2	2.42	0.49
1:C:139:TRP:CE2	1:C:299:LEU:HD21	2.47	0.49
1:D:395:LEU:HD21	1:D:441:TYR:CZ	2.47	0.49
1:E:171:ARG:NH1	1:F:298:GLU:O	2.44	0.49
1:C:61:ALA:HB2	1:C:407:PRO:HD3	1.94	0.49
1:D:250:LEU:HD12	1:D:375:ILE:HG22	1.94	0.49
1:B:121:THR:HA	3:B:3242:TRS:H12	1.94	0.49
1:E:264:LEU:O	1:E:290:ARG:NH2	2.46	0.49
1:B:275:HIS:HA	1:B:280:ALA:O	2.13	0.49
1:F:129:ALA:HB1	1:F:287:VAL:HB	1.95	0.49
1:A:162:VAL:HG11	1:A:166:TRP:HB2	1.93	0.49
1:A:128:GLU:HA	1:A:131:MET:HG3	1.94	0.49
1:E:329:TYR:CE2	1:E:333:ARG:HD3	2.48	0.49
1:F:343:GLN:OE1	1:F:343:GLN:HA	2.13	0.49
1:C:217:TYR:CD2	1:C:374:GLY:HA2	2.48	0.49
1:B:183:ARG:NE	1:B:414:GLU:OE2	2.46	0.48
1:B:72:VAL:HG11	3:B:3237:TRS:H32	1.95	0.48
1:E:362:PRO:CB	1:E:386:GLU:HG2	2.42	0.48
1:D:124:ILE:HD11	1:D:319:ARG:HD2	1.95	0.48
1:A:344:ASN:O	1:A:348:GLN:HG3	2.13	0.48
1:C:333:ARG:HH22	1:C:427:ARG:HH12	1.60	0.48
1:C:340:THR:O	1:C:344:ASN:HB2	2.13	0.48
1:C:28:GLU:HG2	1:C:31:ARG:HH21	1.79	0.48
1:B:142:ARG:O	1:B:146:GLU:HG3	2.13	0.48

Continued on next page...

Continued from previous page...

Atom-1	Atom-2	Interatomic distance (Å)	Clash overlap (Å)
1:A:154:LYS:O	1:A:201:ASN:HB3	2.13	0.47
1:A:122:ASN:HB2	1:A:286:TRP:CZ3	2.49	0.47
1:C:141:TRP:CZ3	1:C:155:PRO:HG3	2.49	0.47
1:D:162:VAL:HG13	1:D:163:GLN:O	2.15	0.47
1:E:382:LEU:HD22	1:E:388:PRO:HG2	1.95	0.47
1:A:19:GLY:O	1:F:341:LYS:HE2	2.14	0.47
1:D:319:ARG:HB2	1:D:320:PRO:HD2	1.96	0.47
1:D:303:VAL:HG23	1:D:305:TYR:HE1	1.77	0.47
1:E:183:ARG:CG	1:E:414:GLU:HB2	2.43	0.47
1:E:25:THR:O	1:E:29:SER:HB3	2.14	0.47
1:D:356:GLU:HG2	1:D:438:LEU:CD1	2.44	0.47
1:A:254:VAL:HG21	1:A:347:TYR:CE2	2.49	0.47
1:C:414:GLU:O	1:C:414:GLU:HG2	2.14	0.47
1:B:121:THR:CB	3:B:3242:TRS:H12	2.44	0.47
1:A:163:GLN:HG2	4:A:3293:HOH:O	2.14	0.47
1:B:411:LEU:O	1:B:416:THR:HA	2.15	0.47
1:B:422:ARG:HH11	1:B:422:ARG:HG2	1.80	0.47
1:B:7:THR:HA	1:C:255:ALA:HA	1.95	0.47
1:D:61:ALA:HB2	1:D:407:PRO:HD3	1.96	0.47
1:B:46:ILE:O	1:B:50:LEU:HG	2.14	0.47
1:C:114:LYS:HZ2	1:C:292:GLU:CG	2.26	0.47
1:C:315:ILE:HD13	1:D:315:ILE:HD13	1.96	0.47
1:A:402:ARG:HD2	1:A:440:ASP:OD1	2.15	0.47
1:E:306:LEU:HD21	1:F:400:ARG:CZ	2.45	0.47
1:E:362:PRO:CG	1:E:388:PRO:HG3	2.45	0.47
1:A:398:ARG:HD3	4:A:3318:HOH:O	2.15	0.47
1:B:269:SER:HB3	1:B:289:TRP:CD1	2.50	0.47
1:D:224:HIS:CD2	1:D:264:LEU:HB3	2.50	0.47
1:D:275:HIS:HA	1:D:280:ALA:O	2.14	0.47
1:B:182:MET:HG3	1:B:187:LEU:O	2.15	0.47
1:B:31:ARG:HH11	1:B:34:LEU:HD11	1.80	0.47
1:C:41:VAL:O	1:C:45:ILE:HG13	2.14	0.47
1:A:38:ARG:HB3	1:A:38:ARG:HE	1.52	0.46
1:D:242:ILE:CD1	1:D:267:VAL:HG22	2.42	0.46
1:E:337:GLU:HB2	4:F:3399:HOH:O	2.15	0.46
1:E:356:GLU:HG2	1:E:438:LEU:HD13	1.97	0.46
1:D:239:ASP:OD2	1:D:268:LYS:NZ	2.47	0.46
1:A:188:PHE:HZ	1:A:216:ASN:HD22	1.64	0.46
1:C:224:HIS:CD2	1:C:266:ARG:HB2	2.51	0.46
1:C:143:LYS:HE3	1:C:298:GLU:OE1	2.16	0.46
1:A:109:HIS:HD2	1:A:261:ASP:OD2	1.98	0.46

Continued on next page...

Continued from previous page...

Atom-1	Atom-2	Interatomic distance (Å)	Clash overlap (Å)
1:A:356:GLU:HG2	1:A:438:LEU:CD1	2.46	0.46
1:D:163:GLN:HG2	4:D:3356:HOH:O	2.16	0.46
1:D:186:GLN:O	1:D:186:GLN:HG3	2.15	0.46
1:F:121:THR:HA	3:F:3248:TRS:H31	1.97	0.46
1:B:52:LEU:HB3	3:C:3252:TRS:H32	1.98	0.46
1:D:414:GLU:C	1:D:416:THR:H	2.19	0.46
1:A:195:ILE:HD11	1:A:230:PHE:HB2	1.98	0.46
1:D:181:PRO:O	1:D:193:ARG:NH2	2.45	0.46
1:A:343:GLN:HA	1:A:343:GLN:OE1	2.15	0.46
1:F:23:ILE:HG21	1:F:37:MET:CE	2.46	0.46
1:D:381:LYS:HE2	4:D:3386:HOH:O	2.16	0.46
1:F:344:ASN:O	1:F:348:GLN:HG3	2.17	0.45
1:A:91:PRO:HB2	3:C:3252:TRS:C1	2.39	0.45
1:B:16:SER:O	1:C:427:ARG:HD2	2.16	0.45
1:B:180:ILE:HD12	1:B:180:ILE:N	2.31	0.45
1:E:182:MET:CE	1:E:187:LEU:HB3	2.45	0.45
1:E:183:ARG:HE	1:E:414:GLU:CG	2.29	0.45
1:C:245:ALA:HA	1:C:272:ALA:HA	1.97	0.45
1:B:124:ILE:HD11	1:B:319:ARG:HD2	1.97	0.45
1:E:122:ASN:HB2	1:E:286:TRP:CZ3	2.51	0.45
1:F:216:ASN:HD21	1:F:366:ILE:HG22	1.82	0.45
1:B:245:ALA:HA	1:B:272:ALA:HA	1.99	0.45
1:C:63:PHE:HA	1:C:424:MET:HE2	1.98	0.45
1:A:139:TRP:O	1:A:143:LYS:HG3	2.16	0.45
1:B:157:LEU:HD22	1:B:204:GLY:O	2.17	0.45
1:C:13:LEU:N	4:C:3318:HOH:O	2.50	0.45
1:E:217:TYR:CD2	1:E:374:GLY:HA2	2.51	0.45
1:E:131:MET:HE2	1:F:315:ILE:HG23	1.99	0.45
1:F:72:VAL:HG11	3:F:3240:TRS:H12	1.99	0.45
1:B:163:GLN:HG2	4:B:3339:HOH:O	2.16	0.45
1:D:245:ALA:HA	1:D:272:ALA:HA	1.98	0.45
1:F:182:MET:HG3	1:F:187:LEU:O	2.16	0.45
1:F:25:THR:O	1:F:29:SER:HB3	2.17	0.45
1:F:46:ILE:O	1:F:50:LEU:HG	2.16	0.45
1:A:89:GLU:C	1:A:91:PRO:HD3	2.37	0.45
1:B:301:PHE:O	1:B:312:THR:HG22	2.17	0.45
1:D:163:GLN:NE2	1:D:164:ILE:HG22	2.31	0.45
1:D:390:TYR:CA	1:D:455:GLN:HG3	2.45	0.45
1:E:97:ASP:OD2	3:E:3246:TRS:O1	2.33	0.45
1:F:121:THR:HB	3:F:3249:TRS:O2	2.17	0.45
1:F:98:LEU:HD23	3:F:3248:TRS:O1	2.17	0.45

Continued on next page...

Continued from previous page...

Atom-1	Atom-2	Interatomic distance (Å)	Clash overlap (Å)
1:B:119:VAL:HG22	1:B:292:GLU:OE2	2.17	0.45
1:C:312:THR:HG22	3:C:3243:TRS:O2	2.16	0.45
1:C:65:GLN:HG3	3:C:3250:TRS:HN1	1.80	0.44
1:F:221:GLN:CB	1:F:222:PRO:HD3	2.45	0.44
1:A:315:ILE:HD13	1:B:315:ILE:HD13	1.98	0.44
1:C:122:ASN:HB2	1:C:286:TRP:CZ3	2.53	0.44
1:D:83:ASN:OD1	1:D:85:ILE:HG22	2.17	0.44
1:E:124:ILE:HD13	1:E:124:ILE:HA	1.87	0.44
1:E:154:LYS:HE2	1:E:154:LYS:HB3	1.76	0.44
1:E:62:THR:HA	1:E:466:THR:OXT	2.18	0.44
1:A:186:GLN:O	1:A:186:GLN:HG3	2.17	0.44
1:A:156:ASN:OD1	1:A:202:THR:HA	2.16	0.44
1:E:61:ALA:HB2	1:E:407:PRO:HD3	2.00	0.44
1:E:183:ARG:HE	1:E:414:GLU:HG2	1.82	0.44
1:F:30:LYS:C	1:F:31:ARG:HD2	2.37	0.44
1:A:228:ASP:HA	1:A:266:ARG:HH21	1.82	0.44
1:A:59:ASN:HA	1:A:405:GLN:HB3	1.98	0.44
1:F:463:PHE:CE2	1:F:466:THR:HG22	2.52	0.44
1:D:65:GLN:HB3	3:D:3238:TRS:HN1	1.81	0.44
1:E:395:LEU:HD21	1:E:441:TYR:CZ	2.52	0.44
1:A:114:LYS:CE	1:A:292:GLU:HG2	2.47	0.44
1:A:400:ARG:HA	1:A:404:TRP:O	2.17	0.44
1:D:382:LEU:HD22	1:D:388:PRO:HG2	2.00	0.44
1:E:400:ARG:HA	1:E:404:TRP:O	2.18	0.44
1:F:398:ARG:HD2	1:F:398:ARG:N	2.31	0.44
1:F:59:ASN:HA	1:F:405:GLN:HB3	1.99	0.44
1:A:101:VAL:CG2	3:A:3251:TRS:H12	2.47	0.44
1:F:163:GLN:HG2	4:F:3308:HOH:O	2.18	0.44
1:F:61:ALA:HB2	1:F:407:PRO:HD3	2.00	0.44
1:A:98:LEU:CD2	3:A:3251:TRS:O3	2.65	0.44
1:A:453:LYS:NZ	4:A:3435:HOH:O	2.51	0.44
1:B:264:LEU:O	1:B:290:ARG:NH2	2.51	0.43
1:E:275:HIS:HA	1:E:280:ALA:O	2.17	0.43
1:F:24:SER:HB3	1:F:27:ALA:HB3	2.00	0.43
1:A:161:PRO:HB3	1:A:182:MET:HE3	2.00	0.43
1:C:58:GLN:HE22	3:C:3252:TRS:H31	1.83	0.43
1:C:454:LEU:HA	1:C:457:ILE:HD12	2.00	0.43
1:D:459:GLN:HB3	1:D:459:GLN:HE21	1.49	0.43
1:E:410:THR:HA	1:E:418:ILE:O	2.18	0.43
1:A:162:VAL:HG13	1:A:163:GLN:O	2.18	0.43
1:A:217:TYR:CD2	1:A:374:GLY:HA2	2.53	0.43

Continued on next page...

Continued from previous page...

Atom-1	Atom-2	Interatomic distance (Å)	Clash overlap (Å)
1:A:190:ASP:HA	4:A:3322:HOH:O	2.18	0.43
1:A:319:ARG:HB2	1:A:320:PRO:HD2	2.00	0.43
1:F:269:SER:HB3	1:F:289:TRP:CD1	2.53	0.43
1:C:329:TYR:CE2	1:C:333:ARG:HD3	2.54	0.43
1:C:400:ARG:HA	1:C:404:TRP:O	2.19	0.43
1:F:121:THR:CA	3:F:3248:TRS:H31	2.48	0.43
1:D:160:GLY:O	1:D:179:GLU:HG3	2.18	0.43
1:A:36:GLU:HG2	1:B:337:GLU:OE2	2.19	0.43
1:D:410:THR:HG22	1:D:419:VAL:HG22	2.00	0.43
1:F:362:PRO:HB2	1:F:386:GLU:HG2	2.01	0.43
1:B:242:ILE:CD1	1:B:267:VAL:HG22	2.49	0.43
1:B:343:GLN:OE1	1:B:343:GLN:HA	2.19	0.43
1:B:432:ASP:HA	1:C:26:ILE:HD12	2.01	0.43
1:A:164:ILE:HD12	1:A:164:ILE:C	2.38	0.42
1:A:162:VAL:CG2	1:A:166:TRP:CD1	3.01	0.42
1:C:183:ARG:HH11	1:C:183:ARG:HG2	1.84	0.42
1:D:255:ALA:N	1:D:256:PRO:HD3	2.34	0.42
1:E:114:LYS:HE2	4:E:3369:HOH:O	2.18	0.42
1:E:185:GLY:H	3:E:3253:TRS:C1	2.32	0.42
1:A:262:PHE:O	1:A:290:ARG:NH2	2.51	0.42
1:A:417:ASP:HB2	4:A:3419:HOH:O	2.18	0.42
1:C:465:HIS:O	1:C:466:THR:HB	2.19	0.42
1:D:242:ILE:HD13	1:D:267:VAL:CG1	2.50	0.42
1:A:162:VAL:HG22	1:A:166:TRP:HD1	1.81	0.42
3:A:3236:TRS:H12	4:A:3437:HOH:O	2.18	0.42
1:A:216:ASN:HD21	1:A:366:ILE:HG13	1.83	0.42
1:D:252:PRO:HG3	4:D:3282:HOH:O	2.18	0.42
1:D:254:VAL:HG21	1:D:347:TYR:CE2	2.54	0.42
1:E:460:GLN:HG2	1:F:306:LEU:O	2.18	0.42
1:D:219:PHE:HA	1:D:220:PRO:HD3	1.85	0.42
1:D:217:TYR:CD2	1:D:374:GLY:HA2	2.54	0.42
1:E:343:GLN:OE1	1:E:343:GLN:HA	2.19	0.42
1:B:299:LEU:HB3	1:B:313:PHE:CE1	2.54	0.42
1:D:177:LEU:CD1	1:D:179:GLU:HB2	2.49	0.42
1:D:242:ILE:HD12	1:D:242:ILE:N	2.34	0.42
1:E:10:ARG:HG3	1:E:12:GLU:CG	2.50	0.42
1:E:154:LYS:O	1:E:201:ASN:HB3	2.19	0.42
1:E:261:ASP:HB2	1:E:262:PHE:H	1.59	0.42
1:F:314:ALA:HB2	4:F:3340:HOH:O	2.20	0.42
1:A:264:LEU:O	1:A:290:ARG:NH2	2.52	0.42
1:A:303:VAL:HB	1:B:465:HIS:CD2	2.55	0.42

Continued on next page...

Continued from previous page...

Atom-1	Atom-2	Interatomic distance (Å)	Clash overlap (Å)
1:B:59:ASN:HA	1:B:405:GLN:HB3	2.02	0.42
1:E:121:THR:HA	3:E:3246:TRS:H11	2.00	0.42
1:E:12:GLU:HB2	1:E:13:LEU:H	1.65	0.42
1:A:128:GLU:O	1:A:132:LEU:HG	2.19	0.42
1:A:129:ALA:HB1	1:A:287:VAL:HB	2.01	0.42
1:A:390:TYR:N	1:A:455:GLN:NE2	2.67	0.42
1:B:135:MET:HE2	1:B:135:MET:HB3	1.83	0.42
1:B:89:GLU:C	1:B:91:PRO:HD3	2.40	0.42
1:D:264:LEU:O	1:D:290:ARG:NH2	2.53	0.42
1:D:23:ILE:HG21	1:D:37:MET:CE	2.49	0.42
1:E:303:VAL:HG23	1:E:305:TYR:CE2	2.55	0.42
1:A:245:ALA:HA	1:A:272:ALA:HA	2.02	0.42
1:D:451:HIS:N	1:D:452:PRO:HD3	2.35	0.42
1:F:250:LEU:HD23	1:F:343:GLN:CG	2.29	0.42
1:C:199:ASP:OD1	1:C:201:ASN:N	2.43	0.42
1:B:319:ARG:HB2	1:B:320:PRO:CD	2.50	0.42
1:D:465:HIS:O	1:D:466:THR:HB	2.20	0.42
1:E:200:GLU:HG3	1:E:236:ILE:HD11	2.02	0.42
1:F:72:VAL:CG2	3:F:3240:TRS:H12	2.38	0.42
1:A:275:HIS:HA	1:A:280:ALA:O	2.20	0.41
1:B:117:GLN:HB2	4:B:3389:HOH:O	2.20	0.41
1:B:427:ARG:HH21	3:B:3237:TRS:H21	1.84	0.41
1:E:157:LEU:HD12	1:E:204:GLY:O	2.20	0.41
1:B:465:HIS:O	1:B:466:THR:HB	2.20	0.41
1:B:63:PHE:HA	1:B:424:MET:HE2	2.01	0.41
1:D:98:LEU:HD23	3:D:3244:TRS:O3	2.21	0.41
1:F:395:LEU:HD21	1:F:441:TYR:CZ	2.55	0.41
1:B:126:SER:HB2	2:B:1501:PLR:O4P	2.20	0.41
1:B:6:VAL:CA	1:C:257:ASP:HB2	2.49	0.41
1:E:388:PRO:HB2	1:E:390:TYR:CE2	2.55	0.41
1:A:142:ARG:O	1:A:145:MET:HB2	2.21	0.41
1:A:159:CYS:SG	1:A:177:LEU:HD11	2.60	0.41
1:C:46:ILE:O	1:C:50:LEU:HG	2.20	0.41
1:C:67:TRP:O	3:C:3250:TRS:H32	2.21	0.41
1:E:10:ARG:C	1:E:12:GLU:H	2.23	0.41
1:F:180:ILE:HD12	1:F:180:ILE:N	2.35	0.41
1:F:319:ARG:HB2	1:F:320:PRO:HD2	2.01	0.41
1:B:153:ASP:OD2	1:B:154:LYS:HG3	2.21	0.41
1:B:400:ARG:HA	1:B:404:TRP:O	2.21	0.41
1:B:451:HIS:N	1:B:452:PRO:HD3	2.35	0.41
1:C:275:HIS:HA	1:C:280:ALA:O	2.20	0.41

Continued on next page...

Continued from previous page...

Atom-1	Atom-2	Interatomic distance (Å)	Clash overlap (Å)
1:D:344:ASN:HD22	1:D:344:ASN:HA	1.66	0.41
1:E:362:PRO:HG3	1:E:388:PRO:HG3	2.01	0.41
1:E:37:MET:HE1	1:F:332:LEU:HD22	2.03	0.41
1:A:98:LEU:HD21	3:A:3251:TRS:O3	2.21	0.41
1:B:113:PRO:C	1:B:115:ASN:H	2.23	0.41
1:C:183:ARG:HH12	1:C:414:GLU:HB2	1.86	0.41
1:C:371:PRO:HD2	4:C:3367:HOH:O	2.20	0.41
1:E:114:LYS:NZ	1:E:292:GLU:HG2	2.34	0.41
1:A:157:LEU:HD22	1:A:204:GLY:O	2.21	0.41
1:B:352:TYR:OH	1:B:435:GLU:OE2	2.26	0.41
1:D:344:ASN:O	1:D:348:GLN:HG3	2.21	0.41
1:E:114:LYS:HG3	1:E:114:LYS:H	1.61	0.41
1:E:255:ALA:N	1:E:256:PRO:HD3	2.36	0.41
1:F:451:HIS:N	1:F:452:PRO:HD3	2.36	0.41
1:A:131:MET:CE	1:A:169:PHE:HB2	2.51	0.41
1:A:293:GLU:H	1:A:293:GLU:CD	2.23	0.41
1:B:139:TRP:HB3	1:B:296:PRO:HG2	2.01	0.41
1:D:141:TRP:CZ3	1:D:155:PRO:HB3	2.56	0.41
1:A:400:ARG:NE	1:B:306:LEU:HD21	2.36	0.41
1:B:98:LEU:HD23	3:B:3242:TRS:O3	2.21	0.41
1:C:177:LEU:HD11	1:C:179:GLU:HB2	2.03	0.41
1:C:228:ASP:HA	1:C:266:ARG:HH21	1.85	0.41
1:D:182:MET:HG2	1:D:187:LEU:HD22	2.03	0.41
1:E:185:GLY:N	3:E:3253:TRS:O1	2.49	0.41
1:A:112:ALA:HA	1:A:113:PRO:HD3	1.97	0.41
1:A:187:LEU:HD12	1:A:366:ILE:HD12	2.02	0.41
1:C:218:GLU:O	1:C:220:PRO:HD3	2.21	0.41
1:C:395:LEU:HD21	1:C:441:TYR:CZ	2.56	0.41
1:F:186:GLN:O	1:F:186:GLN:HG3	2.21	0.41
1:A:182:MET:HG2	1:A:187:LEU:HD22	2.03	0.41
1:B:61:ALA:HB2	1:B:407:PRO:HD3	2.02	0.41
1:C:114:LYS:HE2	4:C:3389:HOH:O	2.21	0.41
1:C:58:GLN:NE2	3:C:3252:TRS:H31	2.35	0.41
1:C:417:ASP:HB3	4:C:3311:HOH:O	2.21	0.41
1:E:182:MET:HE2	1:E:187:LEU:HD22	2.03	0.41
1:F:275:HIS:NE2	2:F:1505:PLR:O1P	2.48	0.41
1:A:72:VAL:HG11	3:A:3236:TRS:H22	2.03	0.40
1:C:112:ALA:HA	1:C:113:PRO:HD3	1.93	0.40
1:C:219:PHE:HA	1:C:220:PRO:HD3	1.87	0.40
3:D:3244:TRS:H21	3:D:3245:TRS:O3	2.20	0.40
1:E:63:PHE:CD1	1:E:63:PHE:N	2.89	0.40

Continued on next page...

Continued from previous page...

Atom-1	Atom-2	Interatomic distance (Å)	Clash overlap (Å)
1:E:306:LEU:HD21	1:F:400:ARG:NE	2.36	0.40
1:E:286:TRP:HZ2	1:E:327:GLN:HG2	1.86	0.40
1:E:183:ARG:NH2	1:E:414:GLU:HG2	2.29	0.40
1:A:154:LYS:HE2	1:A:154:LYS:HB3	1.85	0.40
1:B:141:TRP:CZ3	1:B:155:PRO:HG3	2.57	0.40
1:B:242:ILE:HD11	1:B:267:VAL:HG22	2.02	0.40
1:D:286:TRP:HZ2	1:D:327:GLN:HG2	1.85	0.40
1:B:157:LEU:HD13	1:B:157:LEU:C	2.42	0.40
1:C:370:ARG:HA	1:C:371:PRO:HD3	1.88	0.40
1:F:400:ARG:HA	1:F:404:TRP:O	2.21	0.40

There are no symmetry-related clashes.

5.3 Torsion angles [i](#)

5.3.1 Protein backbone [i](#)

In the following table, the Percentiles column shows the percent Ramachandran outliers of the chain as a percentile score with respect to all X-ray entries followed by that with respect to entries of similar resolution.

The Analysed column shows the number of residues for which the backbone conformation was analysed, and the total number of residues.

Mol	Chain	Analysed	Favoured	Allowed	Outliers	Percentiles	
1	A	453/466 (97%)	436 (96%)	15 (3%)	2 (0%)	34	42
1	B	461/466 (99%)	446 (97%)	14 (3%)	1 (0%)	47	58
1	C	452/466 (97%)	436 (96%)	14 (3%)	2 (0%)	34	42
1	D	452/466 (97%)	437 (97%)	15 (3%)	0	100	100
1	E	461/466 (99%)	437 (95%)	20 (4%)	4 (1%)	17	20
1	F	452/466 (97%)	440 (97%)	12 (3%)	0	100	100
All	All	2731/2796 (98%)	2632 (96%)	90 (3%)	9 (0%)	41	50

All (9) Ramachandran outliers are listed below:

Mol	Chain	Res	Type
1	C	27	ALA
1	E	12	GLU

Continued on next page...

Continued from previous page...

Mol	Chain	Res	Type
1	A	385	GLY
1	B	116	GLY
1	C	116	GLY
1	E	13	LEU
1	E	22	SER
1	A	387	ASP
1	E	23	ILE

5.3.2 Protein sidechains [i](#)

In the following table, the Percentiles column shows the percent sidechain outliers of the chain as a percentile score with respect to all X-ray entries followed by that with respect to entries of similar resolution.

The Analysed column shows the number of residues for which the sidechain conformation was analysed, and the total number of residues.

Mol	Chain	Analysed	Rotameric	Outliers	Percentiles	
1	A	379/390 (97%)	371 (98%)	8 (2%)	53	70
1	B	387/390 (99%)	377 (97%)	10 (3%)	46	63
1	C	378/390 (97%)	371 (98%)	7 (2%)	57	73
1	D	378/390 (97%)	372 (98%)	6 (2%)	62	78
1	E	387/390 (99%)	380 (98%)	7 (2%)	59	75
1	F	378/390 (97%)	371 (98%)	7 (2%)	57	73
All	All	2287/2340 (98%)	2242 (98%)	45 (2%)	55	72

All (45) residues with a non-rotameric sidechain are listed below:

Mol	Chain	Res	Type
1	A	114	LYS
1	A	162	VAL
1	A	200	GLU
1	A	268	LYS
1	A	293	GLU
1	A	343	GLN
1	A	366	ILE
1	A	414	GLU
1	B	10	ARG
1	B	124	ILE
1	B	139	TRP

Continued on next page...

Continued from previous page...

Mol	Chain	Res	Type
1	B	150	LYS
1	B	153	ASP
1	B	195	ILE
1	B	268	LYS
1	B	343	GLN
1	B	355	ASP
1	B	414	GLU
1	C	268	LYS
1	C	304	ASP
1	C	343	GLN
1	C	344	ASN
1	C	427	ARG
1	C	437	LEU
1	C	459	GLN
1	D	114	LYS
1	D	162	VAL
1	D	268	LYS
1	D	304	ASP
1	D	398	ARG
1	D	459	GLN
1	E	8	ASP
1	E	12	GLU
1	E	21	LYS
1	E	31	ARG
1	E	126	SER
1	E	142	ARG
1	E	268	LYS
1	F	131	MET
1	F	221	GLN
1	F	304	ASP
1	F	343	GLN
1	F	386	GLU
1	F	414	GLU
1	F	437	LEU

Some sidechains can be flipped to improve hydrogen bonding and reduce clashes. All (34) such sidechains are listed below:

Mol	Chain	Res	Type
1	A	71	ASN
1	A	92	GLN
1	A	109	HIS
1	A	186	GLN

Continued on next page...

Continued from previous page...

Mol	Chain	Res	Type
1	A	216	ASN
1	A	297	GLN
1	A	309	GLN
1	A	344	ASN
1	A	405	GLN
1	A	459	GLN
1	B	5	GLN
1	B	109	HIS
1	B	216	ASN
1	B	309	GLN
1	B	459	GLN
1	C	58	GLN
1	C	109	HIS
1	C	186	GLN
1	C	216	ASN
1	C	309	GLN
1	C	459	GLN
1	D	167	HIS
1	D	309	GLN
1	D	344	ASN
1	D	459	GLN
1	E	5	GLN
1	E	221	GLN
1	E	309	GLN
1	E	344	ASN
1	F	58	GLN
1	F	186	GLN
1	F	216	ASN
1	F	309	GLN
1	F	344	ASN

5.3.3 RNA ⓘ

There are no RNA molecules in this entry.

5.4 Non-standard residues in protein, DNA, RNA chains ⓘ

There are no non-standard protein/DNA/RNA residues in this entry.

5.5 Carbohydrates [i](#)

There are no carbohydrates in this entry.

5.6 Ligand geometry [i](#)

24 ligands are modelled in this entry.

In the following table, the Counts columns list the number of bonds (or angles) for which Mogul statistics could be retrieved, the number of bonds (or angles) that are observed in the model and the number of bonds (or angles) that are defined in the Chemical Component Dictionary. The Link column lists molecule types, if any, to which the group is linked. The Z score for a bond length (or angle) is the number of standard deviations the observed value is removed from the expected value. A bond length (or angle) with $|Z| > 2$ is considered an outlier worth inspection. RMSZ is the root-mean-square of all Z scores of the bond lengths (or angles).

Mol	Type	Chain	Res	Link	Bond lengths			Bond angles		
					Counts	RMSZ	# Z > 2	Counts	RMSZ	# Z > 2
3	TRS	D	3244	-	7,7,7	0.41	0	9,9,9	0.37	0
3	TRS	E	3253	-	7,7,7	0.42	0	9,9,9	0.35	0
3	TRS	F	3240	-	7,7,7	0.38	0	9,9,9	0.43	0
3	TRS	C	3252	-	7,7,7	0.39	0	9,9,9	0.38	0
3	TRS	F	3249	-	7,7,7	0.44	0	9,9,9	0.32	0
3	TRS	E	3239	-	7,7,7	0.45	0	9,9,9	0.25	0
3	TRS	B	3242	-	7,7,7	0.42	0	9,9,9	0.36	0
2	PLR	E	1504	-	15,15,15	0.86	0	20,22,22	1.47	5 (25%)
3	TRS	A	3251	-	7,7,7	0.31	0	9,9,9	0.41	0
3	TRS	C	3250	-	7,7,7	0.46	0	9,9,9	0.23	0
2	PLR	C	1502	-	15,15,15	0.92	0	20,22,22	1.43	4 (20%)
3	TRS	A	3241	-	7,7,7	0.40	0	9,9,9	0.36	0
2	PLR	B	1501	-	15,15,15	0.95	1 (6%)	20,22,22	1.49	5 (25%)
3	TRS	E	3246	-	7,7,7	0.49	0	9,9,9	0.26	0
3	TRS	D	3245	-	7,7,7	0.36	0	9,9,9	0.46	0
3	TRS	F	3248	-	7,7,7	0.38	0	9,9,9	0.30	0
3	TRS	A	3236	-	7,7,7	0.42	0	9,9,9	0.28	0
2	PLR	F	1505	-	15,15,15	0.91	0	20,22,22	1.48	5 (25%)
3	TRS	B	3237	-	7,7,7	0.44	0	9,9,9	0.35	0
2	PLR	D	1503	-	15,15,15	0.93	0	20,22,22	1.48	5 (25%)
3	TRS	C	3243	-	7,7,7	0.38	0	9,9,9	0.42	0
2	PLR	A	1500	-	15,15,15	0.73	0	20,22,22	1.42	5 (25%)
3	TRS	E	3247	-	7,7,7	0.34	0	9,9,9	0.51	0
3	TRS	D	3238	-	7,7,7	0.44	0	9,9,9	0.31	0

In the following table, the Chirals column lists the number of chiral outliers, the number of chiral

centers analysed, the number of these observed in the model and the number defined in the Chemical Component Dictionary. Similar counts are reported in the Torsion and Rings columns. '-' means no outliers of that kind were identified.

Mol	Type	Chain	Res	Link	Chirals	Torsions	Rings
3	TRS	D	3244	-	-	9/9/9/9	-
3	TRS	E	3253	-	-	9/9/9/9	-
3	TRS	F	3240	-	-	9/9/9/9	-
3	TRS	C	3252	-	-	9/9/9/9	-
3	TRS	F	3249	-	-	9/9/9/9	-
3	TRS	E	3239	-	-	9/9/9/9	-
3	TRS	B	3242	-	-	9/9/9/9	-
2	PLR	E	1504	-	-	0/6/6/6	0/1/1/1
3	TRS	A	3251	-	-	9/9/9/9	-
3	TRS	C	3250	-	-	9/9/9/9	-
2	PLR	C	1502	-	-	0/6/6/6	0/1/1/1
3	TRS	A	3241	-	-	9/9/9/9	-
2	PLR	B	1501	-	-	0/6/6/6	0/1/1/1
3	TRS	E	3246	-	-	9/9/9/9	-
3	TRS	D	3245	-	-	9/9/9/9	-
3	TRS	F	3248	-	-	9/9/9/9	-
3	TRS	A	3236	-	-	9/9/9/9	-
2	PLR	F	1505	-	-	0/6/6/6	0/1/1/1
3	TRS	B	3237	-	-	9/9/9/9	-
2	PLR	D	1503	-	-	0/6/6/6	0/1/1/1
3	TRS	C	3243	-	-	9/9/9/9	-
2	PLR	A	1500	-	-	0/6/6/6	0/1/1/1
3	TRS	E	3247	-	-	9/9/9/9	-
3	TRS	D	3238	-	-	9/9/9/9	-

All (1) bond length outliers are listed below:

Mol	Chain	Res	Type	Atoms	Z	Observed(Å)	Ideal(Å)
2	B	1501	PLR	C5-C4	2.44	1.43	1.40

All (29) bond angle outliers are listed below:

Mol	Chain	Res	Type	Atoms	Z	Observed(°)	Ideal(°)
2	B	1501	PLR	C4A-C4-C5	2.98	124.00	120.94
2	F	1505	PLR	C4A-C4-C5	2.84	123.86	120.94

Continued on next page...

Continued from previous page...

Mol	Chain	Res	Type	Atoms	Z	Observed(°)	Ideal(°)
2	D	1503	PLR	C4A-C4-C5	2.73	123.75	120.94
2	C	1502	PLR	C4A-C4-C5	2.73	123.74	120.94
2	A	1500	PLR	C4A-C4-C5	2.71	123.72	120.94
2	D	1503	PLR	C6-N1-C2	2.68	124.14	119.17
2	B	1501	PLR	C6-N1-C2	2.64	124.06	119.17
2	E	1504	PLR	C4A-C4-C5	2.57	123.58	120.94
2	D	1503	PLR	C3-C2-N1	-2.57	117.45	120.77
2	A	1500	PLR	C6-N1-C2	2.56	123.92	119.17
2	C	1502	PLR	C6-N1-C2	2.56	123.91	119.17
2	E	1504	PLR	C3-C2-N1	-2.55	117.47	120.77
2	F	1505	PLR	C6-N1-C2	2.54	123.87	119.17
2	F	1505	PLR	C3-C2-N1	-2.53	117.50	120.77
2	E	1504	PLR	C6-N1-C2	2.52	123.84	119.17
2	B	1501	PLR	C3-C2-N1	-2.49	117.55	120.77
2	C	1502	PLR	C3-C2-N1	-2.47	117.57	120.77
2	A	1500	PLR	C3-C2-N1	-2.45	117.60	120.77
2	E	1504	PLR	C2A-C2-C3	2.43	123.89	120.89
2	C	1502	PLR	C2A-C2-C3	2.36	123.80	120.89
2	D	1503	PLR	C2A-C2-C3	2.36	123.80	120.89
2	F	1505	PLR	C2A-C2-C3	2.32	123.75	120.89
2	B	1501	PLR	C2A-C2-C3	2.12	123.51	120.89
2	B	1501	PLR	C4A-C4-C3	-2.12	116.91	120.50
2	A	1500	PLR	C2A-C2-C3	2.06	123.43	120.89
2	E	1504	PLR	O3P-P-O1P	2.05	118.70	110.68
2	A	1500	PLR	O3P-P-O1P	2.04	118.68	110.68
2	F	1505	PLR	C4A-C4-C3	-2.01	117.10	120.50
2	D	1503	PLR	O3P-P-O1P	2.00	118.52	110.68

There are no chirality outliers.

All (162) torsion outliers are listed below:

Mol	Chain	Res	Type	Atoms
3	D	3244	TRS	N-C-C1-O1
3	D	3244	TRS	N-C-C2-O2
3	E	3253	TRS	N-C-C3-O3
3	F	3240	TRS	N-C-C2-O2
3	F	3249	TRS	N-C-C1-O1
3	F	3249	TRS	N-C-C3-O3
3	E	3239	TRS	N-C-C1-O1
3	E	3239	TRS	N-C-C2-O2
3	B	3242	TRS	N-C-C3-O3
3	A	3251	TRS	N-C-C1-O1

Continued on next page...

Continued from previous page...

Mol	Chain	Res	Type	Atoms
3	A	3241	TRS	N-C-C2-O2
3	A	3241	TRS	N-C-C3-O3
3	E	3246	TRS	N-C-C1-O1
3	E	3246	TRS	N-C-C2-O2
3	D	3245	TRS	N-C-C3-O3
3	F	3248	TRS	N-C-C2-O2
3	F	3248	TRS	N-C-C3-O3
3	A	3236	TRS	N-C-C3-O3
3	B	3237	TRS	N-C-C1-O1
3	B	3237	TRS	N-C-C3-O3
3	C	3243	TRS	N-C-C3-O3
3	D	3238	TRS	C3-C-C2-O2
3	D	3238	TRS	N-C-C2-O2
3	D	3244	TRS	C3-C-C1-O1
3	D	3244	TRS	C1-C-C2-O2
3	E	3253	TRS	C2-C-C1-O1
3	E	3253	TRS	C2-C-C3-O3
3	F	3240	TRS	C3-C-C2-O2
3	C	3252	TRS	C3-C-C1-O1
3	F	3249	TRS	C2-C-C1-O1
3	F	3249	TRS	C1-C-C2-O2
3	F	3249	TRS	C1-C-C3-O3
3	E	3239	TRS	C3-C-C1-O1
3	E	3239	TRS	C1-C-C2-O2
3	E	3239	TRS	C2-C-C3-O3
3	B	3242	TRS	C3-C-C2-O2
3	B	3242	TRS	C1-C-C3-O3
3	A	3251	TRS	C2-C-C1-O1
3	C	3250	TRS	C3-C-C2-O2
3	C	3250	TRS	C1-C-C3-O3
3	A	3241	TRS	C3-C-C2-O2
3	A	3241	TRS	C1-C-C3-O3
3	E	3246	TRS	C2-C-C1-O1
3	E	3246	TRS	C1-C-C2-O2
3	E	3246	TRS	C2-C-C3-O3
3	D	3245	TRS	C2-C-C3-O3
3	F	3248	TRS	C1-C-C2-O2
3	F	3248	TRS	C1-C-C3-O3
3	A	3236	TRS	C3-C-C2-O2
3	A	3236	TRS	C1-C-C3-O3
3	B	3237	TRS	C3-C-C1-O1
3	B	3237	TRS	C3-C-C2-O2

Continued on next page...

Continued from previous page...

Mol	Chain	Res	Type	Atoms
3	B	3237	TRS	C2-C-C3-O3
3	C	3243	TRS	C1-C-C3-O3
3	D	3238	TRS	C3-C-C1-O1
3	D	3238	TRS	C1-C-C3-O3
3	D	3244	TRS	C2-C-C1-O1
3	D	3244	TRS	C3-C-C2-O2
3	D	3244	TRS	C1-C-C3-O3
3	D	3244	TRS	N-C-C3-O3
3	E	3253	TRS	N-C-C1-O1
3	E	3253	TRS	C3-C-C2-O2
3	E	3253	TRS	N-C-C2-O2
3	E	3253	TRS	C1-C-C3-O3
3	F	3240	TRS	C3-C-C1-O1
3	F	3240	TRS	N-C-C1-O1
3	F	3240	TRS	C1-C-C2-O2
3	F	3240	TRS	C1-C-C3-O3
3	F	3240	TRS	N-C-C3-O3
3	C	3252	TRS	N-C-C1-O1
3	C	3252	TRS	C3-C-C2-O2
3	C	3252	TRS	C2-C-C3-O3
3	C	3252	TRS	N-C-C3-O3
3	F	3249	TRS	C3-C-C1-O1
3	F	3249	TRS	N-C-C2-O2
3	E	3239	TRS	C2-C-C1-O1
3	E	3239	TRS	N-C-C3-O3
3	B	3242	TRS	C2-C-C1-O1
3	B	3242	TRS	N-C-C1-O1
3	B	3242	TRS	N-C-C2-O2
3	B	3242	TRS	C2-C-C3-O3
3	A	3251	TRS	C3-C-C1-O1
3	A	3251	TRS	C1-C-C2-O2
3	A	3251	TRS	N-C-C2-O2
3	A	3251	TRS	C1-C-C3-O3
3	A	3251	TRS	N-C-C3-O3
3	C	3250	TRS	C3-C-C1-O1
3	C	3250	TRS	N-C-C2-O2
3	C	3250	TRS	N-C-C3-O3
3	A	3241	TRS	C3-C-C1-O1
3	A	3241	TRS	C1-C-C2-O2
3	A	3241	TRS	C2-C-C3-O3
3	E	3246	TRS	N-C-C3-O3
3	D	3245	TRS	C2-C-C1-O1

Continued on next page...

Continued from previous page...

Mol	Chain	Res	Type	Atoms
3	D	3245	TRS	N-C-C1-O1
3	D	3245	TRS	C3-C-C2-O2
3	D	3245	TRS	N-C-C2-O2
3	D	3245	TRS	C1-C-C3-O3
3	F	3248	TRS	C2-C-C1-O1
3	F	3248	TRS	N-C-C1-O1
3	A	3236	TRS	C3-C-C1-O1
3	A	3236	TRS	N-C-C2-O2
3	A	3236	TRS	C2-C-C3-O3
3	B	3237	TRS	C2-C-C1-O1
3	B	3237	TRS	N-C-C2-O2
3	B	3237	TRS	C1-C-C3-O3
3	C	3243	TRS	C3-C-C1-O1
3	C	3243	TRS	N-C-C1-O1
3	C	3243	TRS	C1-C-C2-O2
3	C	3243	TRS	N-C-C2-O2
3	C	3243	TRS	C2-C-C3-O3
3	E	3247	TRS	C3-C-C1-O1
3	E	3247	TRS	N-C-C1-O1
3	E	3247	TRS	C1-C-C2-O2
3	E	3247	TRS	N-C-C2-O2
3	E	3247	TRS	C2-C-C3-O3
3	E	3247	TRS	N-C-C3-O3
3	D	3238	TRS	N-C-C1-O1
3	D	3238	TRS	C1-C-C2-O2
3	D	3238	TRS	N-C-C3-O3
3	D	3244	TRS	C2-C-C3-O3
3	E	3253	TRS	C3-C-C1-O1
3	E	3253	TRS	C1-C-C2-O2
3	F	3240	TRS	C2-C-C1-O1
3	F	3240	TRS	C2-C-C3-O3
3	C	3252	TRS	C2-C-C1-O1
3	C	3252	TRS	C1-C-C2-O2
3	C	3252	TRS	C1-C-C3-O3
3	F	3249	TRS	C3-C-C2-O2
3	F	3249	TRS	C2-C-C3-O3
3	E	3239	TRS	C3-C-C2-O2
3	E	3239	TRS	C1-C-C3-O3
3	B	3242	TRS	C3-C-C1-O1
3	B	3242	TRS	C1-C-C2-O2
3	A	3251	TRS	C3-C-C2-O2
3	A	3251	TRS	C2-C-C3-O3

Continued on next page...

Continued from previous page...

Mol	Chain	Res	Type	Atoms
3	C	3250	TRS	C2-C-C1-O1
3	C	3250	TRS	C1-C-C2-O2
3	C	3250	TRS	C2-C-C3-O3
3	A	3241	TRS	C2-C-C1-O1
3	E	3246	TRS	C3-C-C1-O1
3	E	3246	TRS	C3-C-C2-O2
3	E	3246	TRS	C1-C-C3-O3
3	D	3245	TRS	C3-C-C1-O1
3	D	3245	TRS	C1-C-C2-O2
3	F	3248	TRS	C3-C-C1-O1
3	F	3248	TRS	C3-C-C2-O2
3	F	3248	TRS	C2-C-C3-O3
3	A	3236	TRS	C2-C-C1-O1
3	A	3236	TRS	C1-C-C2-O2
3	B	3237	TRS	C1-C-C2-O2
3	C	3243	TRS	C2-C-C1-O1
3	C	3243	TRS	C3-C-C2-O2
3	E	3247	TRS	C2-C-C1-O1
3	E	3247	TRS	C3-C-C2-O2
3	E	3247	TRS	C1-C-C3-O3
3	D	3238	TRS	C2-C-C1-O1
3	D	3238	TRS	C2-C-C3-O3
3	C	3252	TRS	N-C-C2-O2
3	C	3250	TRS	N-C-C1-O1
3	A	3241	TRS	N-C-C1-O1
3	A	3236	TRS	N-C-C1-O1

There are no ring outliers.

19 monomers are involved in 80 short contacts:

Mol	Chain	Res	Type	Clashes	Symm-Clashes
3	D	3244	TRS	5	0
3	E	3253	TRS	3	0
3	F	3240	TRS	5	0
3	C	3252	TRS	7	0
3	F	3249	TRS	4	0
3	E	3239	TRS	4	0
3	B	3242	TRS	5	0
3	A	3251	TRS	7	0
3	C	3250	TRS	6	0
2	C	1502	PLR	1	0
2	B	1501	PLR	1	0

Continued on next page...

Continued from previous page...

Mol	Chain	Res	Type	Clashes	Symm-Clashes
3	E	3246	TRS	7	0
3	D	3245	TRS	1	0
3	F	3248	TRS	8	0
3	A	3236	TRS	5	0
2	F	1505	PLR	1	0
3	B	3237	TRS	2	0
3	C	3243	TRS	5	0
3	D	3238	TRS	4	0

5.7 Other polymers [i](#)

There are no such residues in this entry.

5.8 Polymer linkage issues [i](#)

There are no chain breaks in this entry.

6 Fit of model and data

6.1 Protein, DNA and RNA chains

In the following table, the column labelled ‘#RSRZ> 2’ contains the number (and percentage) of RSRZ outliers, followed by percent RSRZ outliers for the chain as percentile scores relative to all X-ray entries and entries of similar resolution. The OWAB column contains the minimum, median, 95th percentile and maximum values of the occupancy-weighted average B-factor per residue. The column labelled ‘Q< 0.9’ lists the number of (and percentage) of residues with an average occupancy less than 0.9.

Mol	Chain	Analysed	<RSRZ>	#RSRZ>2	OWAB(Å ²)	Q<0.9
1	A	455/466 (97%)	0.06	21 (4%) 32 39	16, 26, 46, 58	0
1	B	463/466 (99%)	0.04	27 (5%) 23 29	16, 27, 47, 56	0
1	C	454/466 (97%)	0.00	20 (4%) 34 41	13, 25, 47, 59	0
1	D	454/466 (97%)	0.03	25 (5%) 25 31	16, 26, 45, 53	0
1	E	463/466 (99%)	0.02	24 (5%) 27 34	14, 24, 51, 64	0
1	F	454/466 (97%)	0.01	18 (3%) 38 45	14, 25, 45, 55	0
All	All	2743/2796 (98%)	0.03	135 (4%) 29 36	13, 26, 47, 64	0

All (135) RSRZ outliers are listed below:

Mol	Chain	Res	Type	RSRZ
1	C	115	ASN	7.4
1	F	115	ASN	6.1
1	E	12	GLU	5.7
1	A	115	ASN	5.4
1	E	115	ASN	5.2
1	A	116	GLY	5.2
1	B	308	GLY	5.1
1	D	115	ASN	5.0
1	B	115	ASN	4.8
1	D	13	LEU	4.8
1	E	13	LEU	4.8
1	B	114	LYS	4.5
1	B	147	ALA	4.4
1	D	147	ALA	4.4
1	C	413	GLY	4.2
1	E	7	THR	4.2
1	A	308	GLY	4.1
1	D	116	GLY	4.0
1	F	385	GLY	4.0

Continued on next page...

Continued from previous page...

Mol	Chain	Res	Type	RSRZ
1	D	414	GLU	3.9
1	F	28	GLU	3.8
1	D	417	ASP	3.8
1	B	28	GLU	3.7
1	B	112	ALA	3.7
1	E	310	ILE	3.7
1	C	414	GLU	3.6
1	E	28	GLU	3.6
1	D	27	ALA	3.5
1	D	385	GLY	3.5
1	A	28	GLU	3.5
1	B	116	GLY	3.4
1	F	417	ASP	3.4
1	D	114	LYS	3.4
1	A	12	GLU	3.3
1	C	415	ALA	3.3
1	A	27	ALA	3.3
1	D	459	GLN	3.3
1	A	387	ASP	3.3
1	C	31	ARG	3.3
1	B	416	THR	3.3
1	C	114	LYS	3.2
1	A	386	GLU	3.2
1	F	147	ALA	3.2
1	F	27	ALA	3.2
1	A	307	GLY	3.1
1	D	185	GLY	3.1
1	D	308	GLY	3.1
1	A	414	GLU	3.0
1	B	414	GLU	3.0
1	E	415	ALA	2.9
1	A	30	LYS	2.9
1	B	309	GLN	2.9
1	C	112	ALA	2.9
1	E	306	LEU	2.9
1	A	114	LYS	2.8
1	D	28	GLU	2.8
1	E	308	GLY	2.8
1	E	309	GLN	2.8
1	B	297	GLN	2.8
1	D	113	PRO	2.8
1	C	116	GLY	2.8

Continued on next page...

Continued from previous page...

Mol	Chain	Res	Type	RSRZ
1	B	384	ASP	2.7
1	D	26	ILE	2.7
1	E	114	LYS	2.7
1	B	311	GLY	2.6
1	C	13	LEU	2.6
1	B	148	ALA	2.6
1	D	305	TYR	2.6
1	F	114	LYS	2.6
1	A	154	LYS	2.6
1	C	28	GLU	2.6
1	D	149	GLY	2.5
1	E	413	GLY	2.5
1	E	22	SER	2.5
1	E	23	ILE	2.5
1	A	186	GLN	2.5
1	F	459	GLN	2.5
1	B	257	ASP	2.5
1	F	310	ILE	2.5
1	D	257	ASP	2.4
1	E	416	THR	2.4
1	A	385	GLY	2.4
1	B	385	GLY	2.4
1	A	34	LEU	2.4
1	D	460	GLN	2.4
1	E	186	GLN	2.4
1	B	153	ASP	2.3
1	F	307	GLY	2.3
1	E	19	GLY	2.3
1	F	414	GLU	2.3
1	C	417	ASP	2.3
1	B	307	GLY	2.3
1	C	385	GLY	2.3
1	F	26	ILE	2.3
1	E	8	ASP	2.3
1	B	113	PRO	2.3
1	B	293	GLU	2.3
1	E	116	GLY	2.3
1	E	385	GLY	2.3
1	F	183	ARG	2.3
1	D	233	ASP	2.3
1	B	143	LYS	2.3
1	B	11	SER	2.3

Continued on next page...

Continued from previous page...

Mol	Chain	Res	Type	RSRZ
1	D	386	GLU	2.3
1	C	183	ARG	2.2
1	D	293	GLU	2.2
1	B	31	ARG	2.2
1	B	303	VAL	2.2
1	F	13	LEU	2.2
1	E	11	SER	2.2
1	C	149	GLY	2.2
1	D	232	ALA	2.2
1	A	192	LYS	2.2
1	F	149	GLY	2.2
1	C	27	ALA	2.2
1	C	416	THR	2.1
1	B	417	ASP	2.1
1	C	144	ARG	2.1
1	A	310	ILE	2.1
1	E	305	TYR	2.1
1	C	307	GLY	2.1
1	D	310	ILE	2.1
1	E	113	PRO	2.1
1	B	305	TYR	2.1
1	F	113	PRO	2.1
1	F	384	ASP	2.1
1	C	113	PRO	2.1
1	B	26	ILE	2.1
1	D	186	GLN	2.1
1	A	293	GLU	2.1
1	E	26	ILE	2.0
1	F	116	GLY	2.0
1	C	305	TYR	2.0
1	A	384	ASP	2.0
1	A	450	ASP	2.0

6.2 Non-standard residues in protein, DNA, RNA chains [i](#)

There are no non-standard protein/DNA/RNA residues in this entry.

6.3 Carbohydrates [i](#)

There are no carbohydrates in this entry.

6.4 Ligands [i](#)

In the following table, the Atoms column lists the number of modelled atoms in the group and the number defined in the chemical component dictionary. The B-factors column lists the minimum, median, 95th percentile and maximum values of B factors of atoms in the group. The column labelled 'Q< 0.9' lists the number of atoms with occupancy less than 0.9.

Mol	Type	Chain	Res	Atoms	RSCC	RSR	B-factors(Å ²)	Q<0.9
3	TRS	E	3253	8/8	0.72	0.30	62,62,62,62	0
3	TRS	B	3242	8/8	0.74	0.29	63,65,66,67	0
3	TRS	C	3250	8/8	0.77	0.35	55,56,57,57	0
3	TRS	F	3240	8/8	0.78	0.28	60,61,61,61	0
3	TRS	C	3243	8/8	0.78	0.28	58,60,60,60	0
3	TRS	A	3251	8/8	0.81	0.33	48,49,50,51	0
3	TRS	D	3245	8/8	0.83	0.33	65,65,65,66	0
3	TRS	E	3239	8/8	0.84	0.28	47,48,49,49	0
3	TRS	C	3252	8/8	0.84	0.38	54,54,54,55	0
3	TRS	D	3238	8/8	0.84	0.26	54,55,55,56	0
3	TRS	A	3241	8/8	0.85	0.24	65,66,66,66	0
3	TRS	D	3244	8/8	0.86	0.30	58,58,59,59	0
3	TRS	E	3247	8/8	0.86	0.23	47,47,48,49	0
3	TRS	F	3248	8/8	0.86	0.21	56,58,59,59	0
3	TRS	A	3236	8/8	0.89	0.27	64,64,65,65	0
3	TRS	B	3237	8/8	0.90	0.28	73,73,74,74	0
3	TRS	E	3246	8/8	0.90	0.19	48,51,51,53	0
3	TRS	F	3249	8/8	0.92	0.21	60,60,60,61	0
2	PLR	F	1505	15/15	0.97	0.10	20,24,25,27	0
2	PLR	A	1500	15/15	0.97	0.12	26,27,27,28	0
2	PLR	E	1504	15/15	0.97	0.11	17,21,22,22	0
2	PLR	D	1503	15/15	0.97	0.10	23,27,29,30	0
2	PLR	B	1501	15/15	0.98	0.09	23,24,26,26	0
2	PLR	C	1502	15/15	0.98	0.11	18,22,22,23	0

6.5 Other polymers [i](#)

There are no such residues in this entry.