



wwPDB X-ray Structure Validation Summary Report ⓘ

Nov 1, 2023 – 09:35 PM EDT

PDB ID : 3MI0
Title : Crystal Structure of Mycobacterium Tuberculosis Proteasome at 2.2 Å
Authors : Li, D.; Li, H.
Deposited on : 2010-04-09
Resolution : 2.20 Å(reported)

This is a wwPDB X-ray Structure Validation Summary Report for a publicly released PDB entry.

We welcome your comments at validation@mail.wwpdb.org

A user guide is available at

<https://www.wwpdb.org/validation/2017/XrayValidationReportHelp>

with specific help available everywhere you see the ⓘ symbol.

The types of validation reports are described at

<https://www.wwpdb.org/validation/2017/FAQs#types>.

The following versions of software and data (see [references ⓘ](#)) were used in the production of this report:

MolProbity : 4.02b-467
Mogul : 1.8.5 (274361), CSD as541be (2020)
Xtriage (Phenix) : 1.13
EDS : 2.36
buster-report : 1.1.7 (2018)
Percentile statistics : 20191225.v01 (using entries in the PDB archive December 25th 2019)
Refmac : 5.8.0158
CCP4 : 7.0.044 (Gargrove)
Ideal geometry (proteins) : Engh & Huber (2001)
Ideal geometry (DNA, RNA) : Parkinson et al. (1996)
Validation Pipeline (wwPDB-VP) : 2.36

1 Overall quality at a glance

The following experimental techniques were used to determine the structure:

X-RAY DIFFRACTION

The reported resolution of this entry is 2.20 Å.

Percentile scores (ranging between 0-100) for global validation metrics of the entry are shown in the following graphic. The table shows the number of entries on which the scores are based.

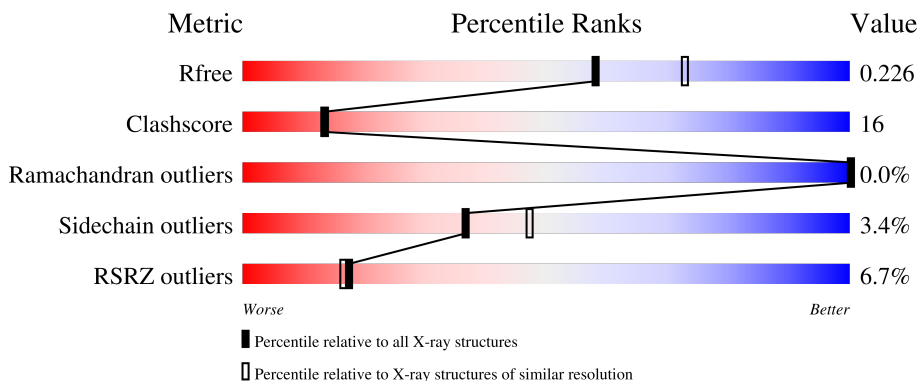











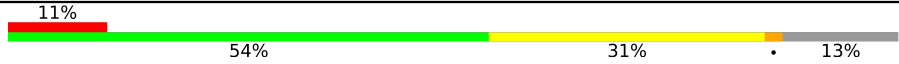
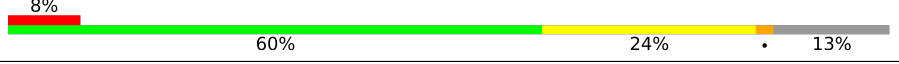

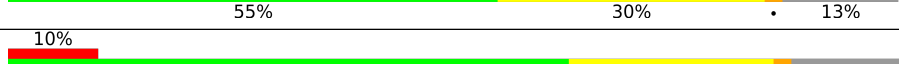
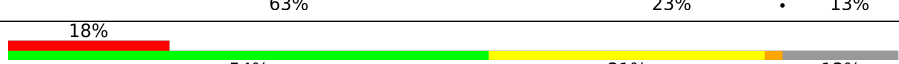
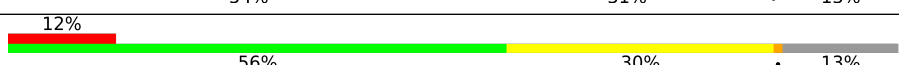
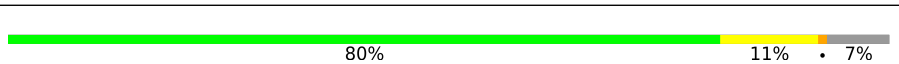
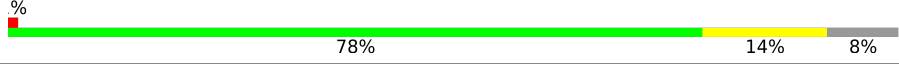
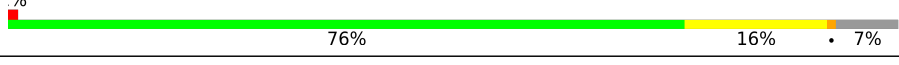
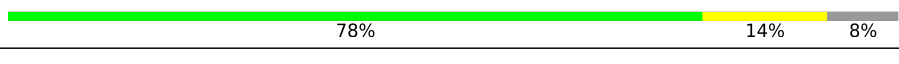
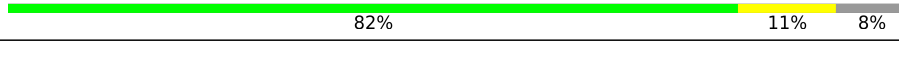

Metric	Whole archive (#Entries)	Similar resolution (#Entries, resolution range(Å))
R_{free}	130704	4898 (2.20-2.20)
Clashscore	141614	5594 (2.20-2.20)
Ramachandran outliers	138981	5503 (2.20-2.20)
Sidechain outliers	138945	5504 (2.20-2.20)
RSRZ outliers	127900	4800 (2.20-2.20)

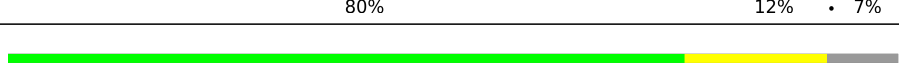
The table below summarises the geometric issues observed across the polymeric chains and their fit to the electron density. The red, orange, yellow and green segments of the lower bar indicate the fraction of residues that contain outliers for ≥ 3 , 2, 1 and 0 types of geometric quality criteria respectively. A grey segment represents the fraction of residues that are not modelled. The numeric value for each fraction is indicated below the corresponding segment, with a dot representing fractions $\leq 5\%$. The upper red bar (where present) indicates the fraction of residues that have poor fit to the electron density. The numeric value is given above the bar.

Mol	Chain	Length	Quality of chain
1	1	248	 7% 64% 21% 13%
1	A	248	 12% 60% 24% 13%
1	B	248	 6% 59% 24% 14%
1	D	248	 24% 50% 34% 14%
1	F	248	 7% 60% 27% 11%

Continued on next page...

Continued from previous page...

Mol	Chain	Length	Quality of chain
1	I	248	
1	K	248	
1	M	248	
1	O	248	
1	Q	248	
1	S	248	
1	U	248	
1	W	248	
1	Y	248	
2	2	240	
2	C	240	
2	E	240	
2	G	240	
2	H	240	
2	J	240	
2	L	240	
2	N	240	
2	P	240	
2	R	240	
2	T	240	
2	V	240	
2	X	240	
2	Z	240	

The following table lists non-polymeric compounds, carbohydrate monomers and non-standard residues in protein, DNA, RNA chains that are outliers for geometric or electron-density-fit criteria:

Mol	Type	Chain	Res	Chirality	Geometry	Clashes	Electron density
3	DMF	2	108	-	-	X	-
3	DMF	2	112	-	-	X	X
3	DMF	2	4	-	-	X	-
3	DMF	C	103	-	-	X	-
3	DMF	D	251	-	-	X	-
3	DMF	D	253	-	-	-	X
3	DMF	E	20	-	-	X	-
3	DMF	E	73	-	-	-	X
3	DMF	E	75	-	-	X	-
3	DMF	F	249	-	-	-	X
3	DMF	G	119	-	-	X	-
3	DMF	G	12	-	-	X	-
3	DMF	G	64	-	-	X	-
3	DMF	H	117	-	-	-	X
3	DMF	H	43	-	-	X	-
3	DMF	J	123	-	-	X	-
3	DMF	J	45	-	-	-	X
3	DMF	K	250	-	-	X	-
3	DMF	L	81	-	-	-	X
3	DMF	L	97	-	-	X	-
3	DMF	N	104	-	-	X	X
3	DMF	N	118	-	-	X	-
3	DMF	N	22	-	-	X	-
3	DMF	N	90	-	-	X	-
3	DMF	N	93	-	-	X	-
3	DMF	P	107	-	-	X	-
3	DMF	P	14	-	-	X	-
3	DMF	Q	250	-	-	X	-
3	DMF	R	59	-	-	X	X
3	DMF	R	95	-	-	-	X
3	DMF	T	102	-	-	-	X
3	DMF	T	113	-	-	X	-
3	DMF	T	84	-	-	-	X
3	DMF	U	250	-	-	X	-
3	DMF	V	116	-	-	X	-
3	DMF	V	120	-	-	X	-
3	DMF	V	27	-	-	X	-
3	DMF	V	32	-	-	X	-
3	DMF	V	42	-	-	X	-
3	DMF	V	83	-	-	X	-
3	DMF	W	250	-	-	X	-
3	DMF	Z	114	-	-	-	X

2 Entry composition [i](#)

There are 5 unique types of molecules in this entry. The entry contains 50080 atoms, of which 0 are hydrogens and 0 are deuteriums.

In the tables below, the ZeroOcc column contains the number of atoms modelled with zero occupancy, the AltConf column contains the number of residues with at least one atom in alternate conformation and the Trace column contains the number of residues modelled with at most 2 atoms.

- Molecule 1 is a protein called Proteasome subunit alpha.

Mol	Chain	Residues	Atoms					ZeroOcc	AltConf	Trace
			Total	C	N	O	S			
1	A	215	Total 1654	C 1035	N 303	O 313	S 3	0	0	0
1	B	213	Total 1643	C 1028	N 301	O 311	S 3	0	0	0
1	D	214	Total 1650	C 1033	N 302	O 312	S 3	0	0	0
1	F	220	Total 1699	C 1068	N 308	O 320	S 3	0	0	0
1	I	216	Total 1669	C 1048	N 304	O 314	S 3	0	0	0
1	K	216	Total 1666	C 1045	N 304	O 314	S 3	0	0	0
1	M	216	Total 1666	C 1045	N 304	O 314	S 3	0	0	0
1	O	216	Total 1666	C 1045	N 304	O 314	S 3	0	0	0
1	Q	215	Total 1658	C 1039	N 303	O 313	S 3	0	0	0
1	S	216	Total 1665	C 1044	N 304	O 314	S 3	0	0	0
1	U	216	Total 1662	C 1041	N 304	O 314	S 3	0	0	0
1	W	216	Total 1669	C 1048	N 304	O 314	S 3	0	0	0
1	Y	216	Total 1666	C 1045	N 304	O 314	S 3	0	0	0
1	1	215	Total 1658	C 1039	N 303	O 313	S 3	0	0	0

- Molecule 2 is a protein called Proteasome subunit beta.

Mol	Chain	Residues	Atoms					ZeroOcc	AltConf	Trace
2	C	222	Total 1638	C 1027	N 282	O 324	S 5	0	0	0
2	E	223	Total 1642	C 1029	N 283	O 325	S 5	0	0	0
2	G	222	Total 1638	C 1027	N 282	O 324	S 5	0	0	0
2	H	222	Total 1638	C 1027	N 282	O 324	S 5	0	0	0
2	J	222	Total 1638	C 1027	N 282	O 324	S 5	0	0	0
2	L	223	Total 1642	C 1029	N 283	O 325	S 5	0	0	0
2	N	222	Total 1638	C 1027	N 282	O 324	S 5	0	0	0
2	P	222	Total 1638	C 1027	N 282	O 324	S 5	0	0	0
2	R	239	Total 1767	C 1103	N 310	O 349	S 5	0	0	0
2	T	223	Total 1642	C 1029	N 283	O 325	S 5	0	0	0
2	V	239	Total 1767	C 1103	N 310	O 349	S 5	0	0	0
2	X	223	Total 1642	C 1029	N 283	O 325	S 5	0	0	0
2	Z	223	Total 1642	C 1029	N 283	O 325	S 5	0	0	0
2	2	223	Total 1642	C 1029	N 283	O 325	S 5	0	0	0

There are 84 discrepancies between the modelled and reference sequences:

Chain	Residue	Modelled	Actual	Comment	Reference
C	535	HIS	-	expression tag	UNP O33245
C	536	HIS	-	expression tag	UNP O33245
C	537	HIS	-	expression tag	UNP O33245
C	538	HIS	-	expression tag	UNP O33245
C	539	HIS	-	expression tag	UNP O33245
C	540	HIS	-	expression tag	UNP O33245
E	535	HIS	-	expression tag	UNP O33245
E	536	HIS	-	expression tag	UNP O33245
E	537	HIS	-	expression tag	UNP O33245
E	538	HIS	-	expression tag	UNP O33245
E	539	HIS	-	expression tag	UNP O33245
E	540	HIS	-	expression tag	UNP O33245

Continued on next page...

Continued from previous page...

Chain	Residue	Modelled	Actual	Comment	Reference
G	535	HIS	-	expression tag	UNP O33245
G	536	HIS	-	expression tag	UNP O33245
G	537	HIS	-	expression tag	UNP O33245
G	538	HIS	-	expression tag	UNP O33245
G	539	HIS	-	expression tag	UNP O33245
G	540	HIS	-	expression tag	UNP O33245
H	535	HIS	-	expression tag	UNP O33245
H	536	HIS	-	expression tag	UNP O33245
H	537	HIS	-	expression tag	UNP O33245
H	538	HIS	-	expression tag	UNP O33245
H	539	HIS	-	expression tag	UNP O33245
H	540	HIS	-	expression tag	UNP O33245
J	535	HIS	-	expression tag	UNP O33245
J	536	HIS	-	expression tag	UNP O33245
J	537	HIS	-	expression tag	UNP O33245
J	538	HIS	-	expression tag	UNP O33245
J	539	HIS	-	expression tag	UNP O33245
J	540	HIS	-	expression tag	UNP O33245
L	535	HIS	-	expression tag	UNP O33245
L	536	HIS	-	expression tag	UNP O33245
L	537	HIS	-	expression tag	UNP O33245
L	538	HIS	-	expression tag	UNP O33245
L	539	HIS	-	expression tag	UNP O33245
L	540	HIS	-	expression tag	UNP O33245
N	535	HIS	-	expression tag	UNP O33245
N	536	HIS	-	expression tag	UNP O33245
N	537	HIS	-	expression tag	UNP O33245
N	538	HIS	-	expression tag	UNP O33245
N	539	HIS	-	expression tag	UNP O33245
N	540	HIS	-	expression tag	UNP O33245
P	535	HIS	-	expression tag	UNP O33245
P	536	HIS	-	expression tag	UNP O33245
P	537	HIS	-	expression tag	UNP O33245
P	538	HIS	-	expression tag	UNP O33245
P	539	HIS	-	expression tag	UNP O33245
P	540	HIS	-	expression tag	UNP O33245
R	535	HIS	-	expression tag	UNP O33245
R	536	HIS	-	expression tag	UNP O33245
R	537	HIS	-	expression tag	UNP O33245
R	538	HIS	-	expression tag	UNP O33245
R	539	HIS	-	expression tag	UNP O33245
R	540	HIS	-	expression tag	UNP O33245

Continued on next page...

Continued from previous page...

Chain	Residue	Modelled	Actual	Comment	Reference
T	535	HIS	-	expression tag	UNP O33245
T	536	HIS	-	expression tag	UNP O33245
T	537	HIS	-	expression tag	UNP O33245
T	538	HIS	-	expression tag	UNP O33245
T	539	HIS	-	expression tag	UNP O33245
T	540	HIS	-	expression tag	UNP O33245
V	535	HIS	-	expression tag	UNP O33245
V	536	HIS	-	expression tag	UNP O33245
V	537	HIS	-	expression tag	UNP O33245
V	538	HIS	-	expression tag	UNP O33245
V	539	HIS	-	expression tag	UNP O33245
V	540	HIS	-	expression tag	UNP O33245
X	535	HIS	-	expression tag	UNP O33245
X	536	HIS	-	expression tag	UNP O33245
X	537	HIS	-	expression tag	UNP O33245
X	538	HIS	-	expression tag	UNP O33245
X	539	HIS	-	expression tag	UNP O33245
X	540	HIS	-	expression tag	UNP O33245
Z	535	HIS	-	expression tag	UNP O33245
Z	536	HIS	-	expression tag	UNP O33245
Z	537	HIS	-	expression tag	UNP O33245
Z	538	HIS	-	expression tag	UNP O33245
Z	539	HIS	-	expression tag	UNP O33245
Z	540	HIS	-	expression tag	UNP O33245
2	535	HIS	-	expression tag	UNP O33245
2	536	HIS	-	expression tag	UNP O33245
2	537	HIS	-	expression tag	UNP O33245
2	538	HIS	-	expression tag	UNP O33245
2	539	HIS	-	expression tag	UNP O33245
2	540	HIS	-	expression tag	UNP O33245

- Molecule 3 is DIMETHYLFORMAMIDE (three-letter code: DMF) (formula: C₃H₇NO).

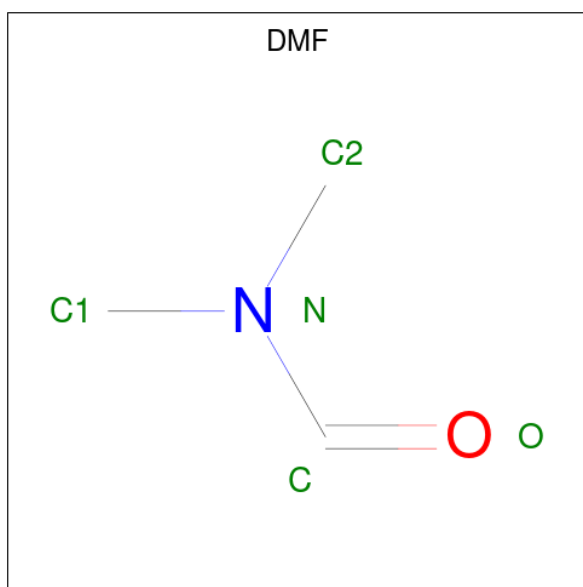

Mol	Chain	Residues	Atoms				ZeroOcc	AltConf
			Total	C	N	O		
3	A	1	5	3	1	1	0	0
3	A	1	5	3	1	1	0	0
3	B	1	5	3	1	1	0	0
3	B	1	5	3	1	1	0	0
3	C	1	5	3	1	1	0	0
3	C	1	5	3	1	1	0	0
3	C	1	5	3	1	1	0	0
3	C	1	5	3	1	1	0	0
3	C	1	5	3	1	1	0	0
3	C	1	5	3	1	1	0	0
3	C	1	5	3	1	1	0	0
3	D	1	5	3	1	1	0	0
3	D	1	5	3	1	1	0	0
3	D	1	5	3	1	1	0	0

Continued on next page...

Continued from previous page...

Mol	Chain	Residues	Atoms				ZeroOcc	AltConf
3	D	1	Total	C	N	O	0	0
			5	3	1	1		
3	D	1	Total	C	N	O	0	0
			5	3	1	1		
3	E	1	Total	C	N	O	0	0
			5	3	1	1		
3	E	1	Total	C	N	O	0	0
			5	3	1	1		
3	E	1	Total	C	N	O	0	0
			5	3	1	1		
3	E	1	Total	C	N	O	0	0
			5	3	1	1		
3	E	1	Total	C	N	O	0	0
			5	3	1	1		
3	F	1	Total	C	N	O	0	0
			5	3	1	1		
3	F	1	Total	C	N	O	0	0
			5	3	1	1		
3	F	1	Total	C	N	O	0	0
			5	3	1	1		
3	G	1	Total	C	N	O	0	0
			5	3	1	1		
3	G	1	Total	C	N	O	0	0
			5	3	1	1		
3	G	1	Total	C	N	O	0	0
			5	3	1	1		
3	G	1	Total	C	N	O	0	0
			5	3	1	1		
3	G	1	Total	C	N	O	0	0
			5	3	1	1		
3	G	1	Total	C	N	O	0	0
			5	3	1	1		
3	G	1	Total	C	N	O	0	0
			5	3	1	1		
3	H	1	Total	C	N	O	0	0
			5	3	1	1		

Continued on next page...

Continued from previous page...

Mol	Chain	Residues	Atoms				ZeroOcc	AltConf
3	H	1	Total 5	C 3	N 1	O 1	0	0
3	H	1	Total 5	C 3	N 1	O 1	0	0
3	H	1	Total 5	C 3	N 1	O 1	0	0
3	H	1	Total 5	C 3	N 1	O 1	0	0
3	H	1	Total 5	C 3	N 1	O 1	0	0
3	I	1	Total 5	C 3	N 1	O 1	0	0
3	I	1	Total 5	C 3	N 1	O 1	0	0
3	J	1	Total 5	C 3	N 1	O 1	0	0
3	J	1	Total 5	C 3	N 1	O 1	0	0
3	J	1	Total 5	C 3	N 1	O 1	0	0
3	K	1	Total 5	C 3	N 1	O 1	0	0
3	K	1	Total 5	C 3	N 1	O 1	0	0
3	K	1	Total 5	C 3	N 1	O 1	0	0
3	K	1	Total 5	C 3	N 1	O 1	0	0
3	L	1	Total 5	C 3	N 1	O 1	0	0
3	L	1	Total 5	C 3	N 1	O 1	0	0
3	L	1	Total 5	C 3	N 1	O 1	0	0
3	L	1	Total 5	C 3	N 1	O 1	0	0
3	M	1	Total 5	C 3	N 1	O 1	0	0
3	M	1	Total 5	C 3	N 1	O 1	0	0
3	M	1	Total 5	C 3	N 1	O 1	0	0

Continued on next page...

Continued from previous page...

Mol	Chain	Residues	Atoms				ZeroOcc	AltConf
3	M	1	Total 5	C 3	N 1	O 1	0	0
3	N	1	Total 5	C 3	N 1	O 1	0	0
3	N	1	Total 5	C 3	N 1	O 1	0	0
3	N	1	Total 5	C 3	N 1	O 1	0	0
3	N	1	Total 5	C 3	N 1	O 1	0	0
3	N	1	Total 5	C 3	N 1	O 1	0	0
3	O	1	Total 5	C 3	N 1	O 1	0	0
3	O	1	Total 5	C 3	N 1	O 1	0	0
3	O	1	Total 5	C 3	N 1	O 1	0	0
3	P	1	Total 5	C 3	N 1	O 1	0	0
3	P	1	Total 5	C 3	N 1	O 1	0	0
3	P	1	Total 5	C 3	N 1	O 1	0	0
3	P	1	Total 5	C 3	N 1	O 1	0	0
3	P	1	Total 5	C 3	N 1	O 1	0	0
3	P	1	Total 5	C 3	N 1	O 1	0	0
3	P	1	Total 5	C 3	N 1	O 1	0	0
3	P	1	Total 5	C 3	N 1	O 1	0	0
3	Q	1	Total 5	C 3	N 1	O 1	0	0
3	Q	1	Total 5	C 3	N 1	O 1	0	0
3	Q	1	Total 5	C 3	N 1	O 1	0	0
3	R	1	Total 5	C 3	N 1	O 1	0	0

Continued on next page...

Continued from previous page...

Mol	Chain	Residues	Atoms				ZeroOcc	AltConf
3	R	1	Total 5	C 3	N 1	O 1	0	0
3	R	1	Total 5	C 3	N 1	O 1	0	0
3	R	1	Total 5	C 3	N 1	O 1	0	0
3	R	1	Total 5	C 3	N 1	O 1	0	0
3	S	1	Total 5	C 3	N 1	O 1	0	0
3	S	1	Total 5	C 3	N 1	O 1	0	0
3	T	1	Total 5	C 3	N 1	O 1	0	0
3	T	1	Total 5	C 3	N 1	O 1	0	0
3	T	1	Total 5	C 3	N 1	O 1	0	0
3	T	1	Total 5	C 3	N 1	O 1	0	0
3	T	1	Total 5	C 3	N 1	O 1	0	0
3	T	1	Total 5	C 3	N 1	O 1	0	0
3	T	1	Total 5	C 3	N 1	O 1	0	0
3	U	1	Total 5	C 3	N 1	O 1	0	0
3	U	1	Total 5	C 3	N 1	O 1	0	0
3	V	1	Total 5	C 3	N 1	O 1	0	0
3	V	1	Total 5	C 3	N 1	O 1	0	0
3	V	1	Total 5	C 3	N 1	O 1	0	0
3	V	1	Total 5	C 3	N 1	O 1	0	0
3	V	1	Total 5	C 3	N 1	O 1	0	0
3	V	1	Total 5	C 3	N 1	O 1	0	0
3	V	1	Total 5	C 3	N 1	O 1	0	0

Continued on next page...

Continued from previous page...

Mol	Chain	Residues	Atoms				ZeroOcc	AltConf
3	V	1	Total 5	C 3	N 1	O 1	0	0
3	V	1	Total 5	C 3	N 1	O 1	0	0
3	W	1	Total 5	C 3	N 1	O 1	0	0
3	W	1	Total 5	C 3	N 1	O 1	0	0
3	X	1	Total 5	C 3	N 1	O 1	0	0
3	X	1	Total 5	C 3	N 1	O 1	0	0
3	X	1	Total 5	C 3	N 1	O 1	0	0
3	X	1	Total 5	C 3	N 1	O 1	0	0
3	X	1	Total 5	C 3	N 1	O 1	0	0
3	X	1	Total 5	C 3	N 1	O 1	0	0
3	Y	1	Total 5	C 3	N 1	O 1	0	0
3	Y	1	Total 5	C 3	N 1	O 1	0	0
3	Y	1	Total 5	C 3	N 1	O 1	0	0
3	Z	1	Total 5	C 3	N 1	O 1	0	0
3	Z	1	Total 5	C 3	N 1	O 1	0	0
3	Z	1	Total 5	C 3	N 1	O 1	0	0
3	Z	1	Total 5	C 3	N 1	O 1	0	0
3	1	1	Total 5	C 3	N 1	O 1	0	0
3	2	1	Total 5	C 3	N 1	O 1	0	0
3	2	1	Total 5	C 3	N 1	O 1	0	0
3	2	1	Total 5	C 3	N 1	O 1	0	0
3	2	1	Total 5	C 3	N 1	O 1	0	0

Continued on next page...

Continued from previous page...

Mol	Chain	Residues	Atoms				ZeroOcc	AltConf
3	2	1	Total	C	N	O	0	0
			5	3	1	1		
3	2	1	Total	C	N	O	0	0
			5	3	1	1		
3	2	1	Total	C	N	O	0	0
			5	3	1	1		
3	2	1	Total	C	N	O	0	0
			5	3	1	1		

- Molecule 4 is (2R,3S,4R)-2-[(S)-(1S)-cyclohex-2-en-1-yl(hydroxy)methyl]-4-ethyl-3-hydroxy-3-methyl-5-oxopyrrolidine-2-carbaldehyde (three-letter code: SA6) (formula: C₁₅H₂₃NO₄).

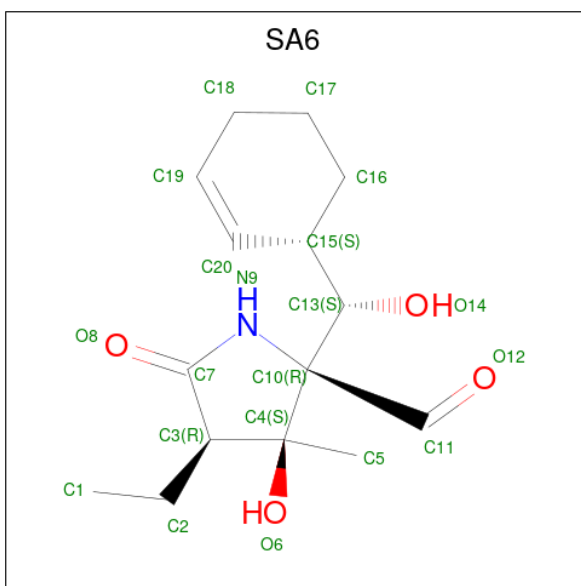

Mol	Chain	Residues	Atoms				ZeroOcc	AltConf
4	C	1	Total	C	N	O	0	0
			20	15	1	4		
4	E	1	Total	C	N	O	0	0
			20	15	1	4		
4	G	1	Total	C	N	O	0	0
			20	15	1	4		
4	H	1	Total	C	N	O	0	0
			20	15	1	4		
4	J	1	Total	C	N	O	0	0
			20	15	1	4		
4	L	1	Total	C	N	O	0	0
			20	15	1	4		
4	N	1	Total	C	N	O	0	0
			20	15	1	4		

Continued on next page...

Continued from previous page...

Mol	Chain	Residues	Atoms				ZeroOcc	AltConf
4	P	1	Total	C	N	O	0	0
			20	15	1	4		
4	R	1	Total	C	N	O	0	0
			20	15	1	4		
4	T	1	Total	C	N	O	0	0
			20	15	1	4		
4	V	1	Total	C	N	O	0	0
			20	15	1	4		
4	X	1	Total	C	N	O	0	0
			20	15	1	4		
4	Z	1	Total	C	N	O	0	0
			20	15	1	4		
4	2	1	Total	C	N	O	0	0
			20	15	1	4		

- Molecule 5 is water.

Mol	Chain	Residues	Atoms		ZeroOcc	AltConf
5	A	43	Total	O	0	0
			43	43		
5	B	41	Total	O	0	0
			41	41		
5	C	163	Total	O	0	0
			163	163		
5	D	40	Total	O	0	0
			40	40		
5	E	166	Total	O	0	0
			166	166		
5	F	58	Total	O	0	0
			58	58		
5	G	131	Total	O	0	0
			131	131		
5	H	148	Total	O	0	0
			148	148		
5	I	52	Total	O	0	0
			52	52		
5	J	142	Total	O	0	0
			142	142		
5	K	45	Total	O	0	0
			45	45		
5	L	153	Total	O	0	0
			153	153		

Continued on next page...

Continued from previous page...

Mol	Chain	Residues	Atoms	ZeroOcc	AltConf
5	M	40	Total O 40 40	0	0
5	N	154	Total O 154 154	0	0
5	O	47	Total O 47 47	0	0
5	P	139	Total O 139 139	0	0
5	Q	38	Total O 38 38	0	0
5	R	170	Total O 170 170	0	0
5	S	42	Total O 42 42	0	0
5	T	116	Total O 116 116	0	0
5	U	49	Total O 49 49	0	0
5	V	177	Total O 177 177	0	0
5	W	35	Total O 35 35	0	0
5	X	150	Total O 150 150	0	0
5	Y	28	Total O 28 28	0	0
5	Z	123	Total O 123 123	0	0
5	1	47	Total O 47 47	0	0
5	2	143	Total O 143 143	0	0

3 Residue-property plots [i](#)

These plots are drawn for all protein, RNA, DNA and oligosaccharide chains in the entry. The first graphic for a chain summarises the proportions of the various outlier classes displayed in the second graphic. The second graphic shows the sequence view annotated by issues in geometry and electron density. Residues are color-coded according to the number of geometric quality criteria for which they contain at least one outlier: green = 0, yellow = 1, orange = 2 and red = 3 or more. A red dot above a residue indicates a poor fit to the electron density ($RSRZ > 2$). Stretches of 2 or more consecutive residues without any outlier are shown as a green connector. Residues present in the sample, but not in the model, are shown in grey.

- Molecule 1: Proteasome subunit alpha

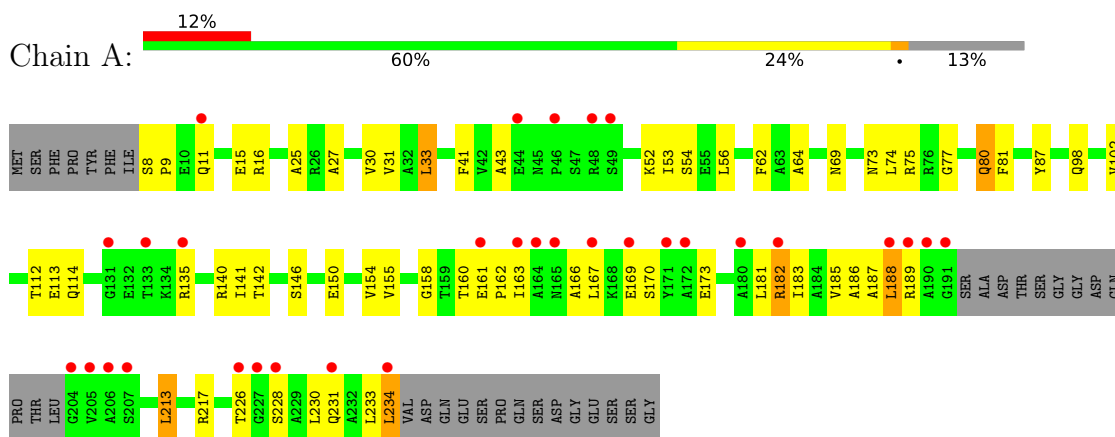

- Molecule 1: Proteasome subunit alpha

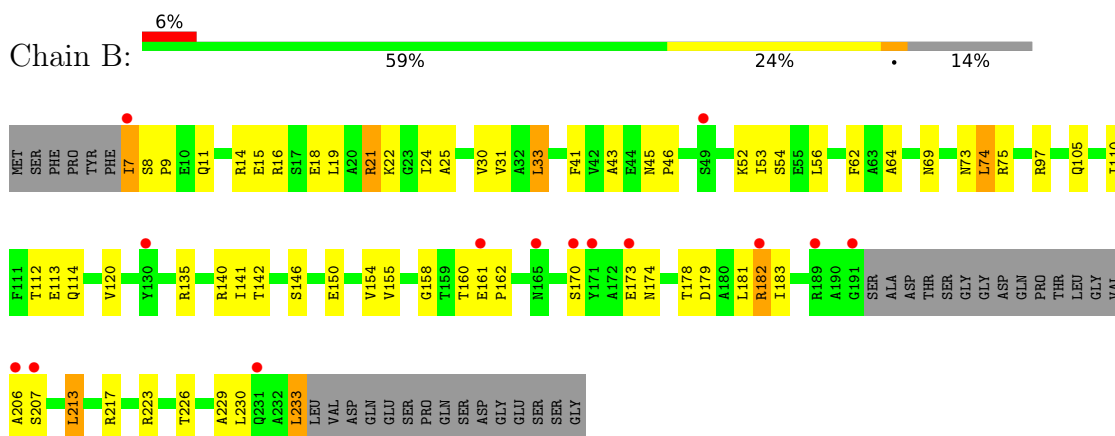

- Molecule 1: Proteasome subunit alpha

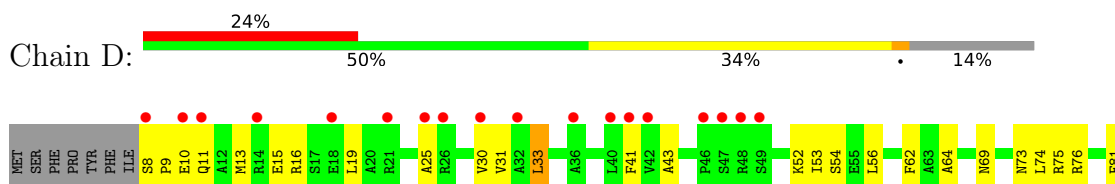

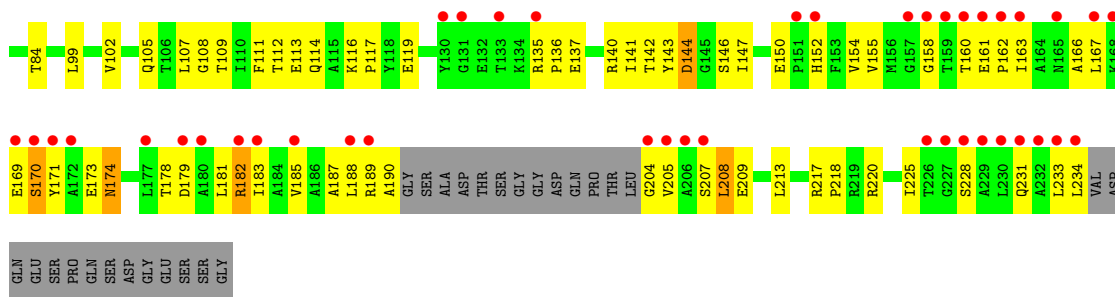

● Molecule 1: Proteasome subunit alpha

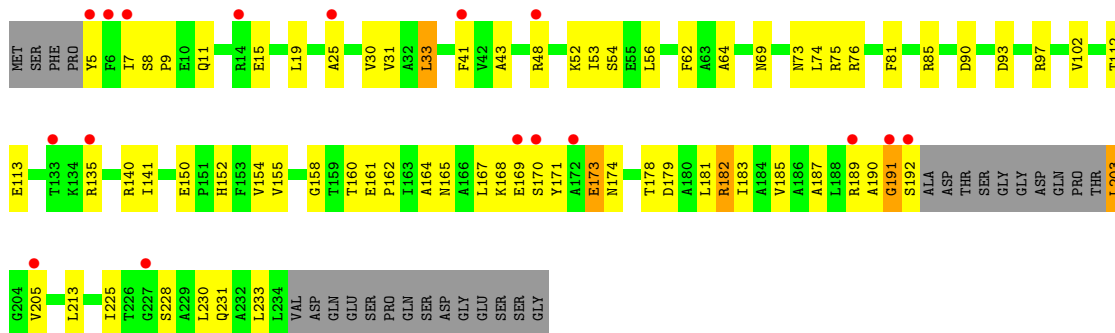

● Molecule 1: Proteasome subunit alpha

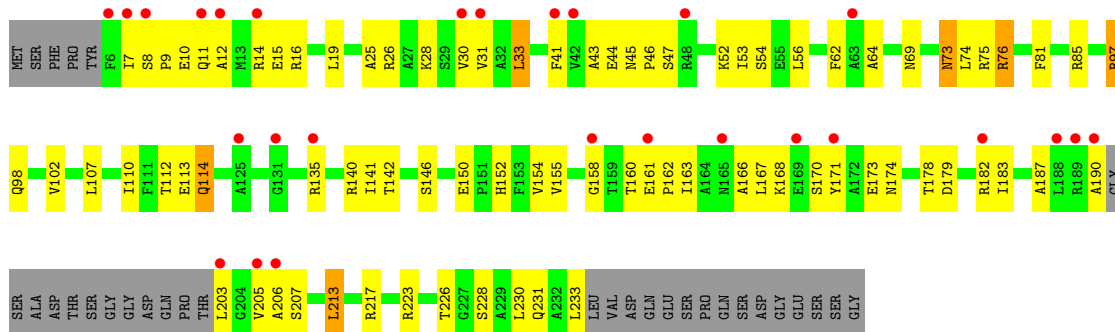

● Molecule 1: Proteasome subunit alpha

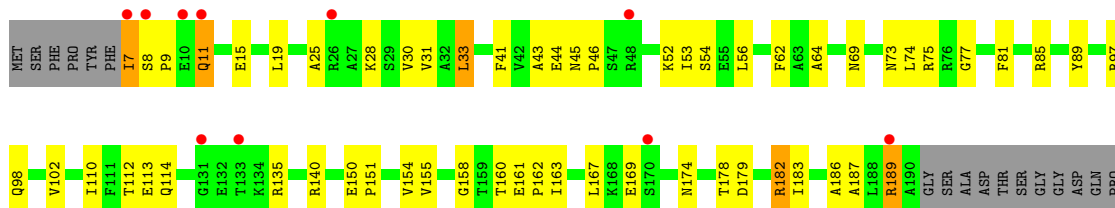

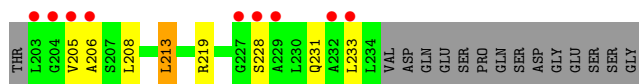

• Molecule 1: Proteasome subunit alpha

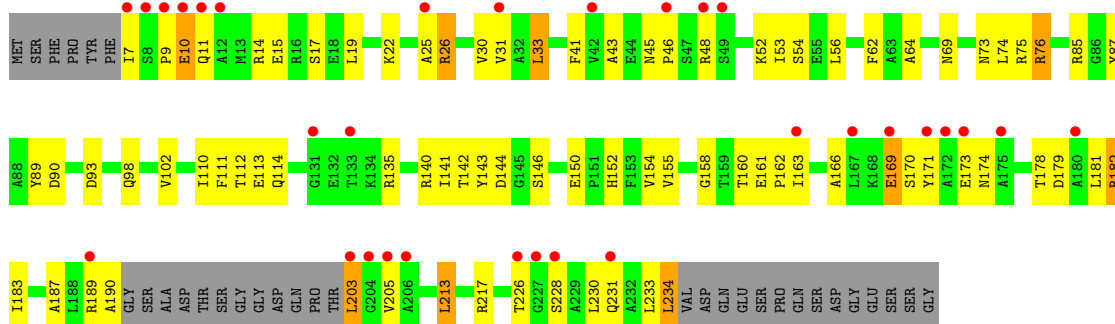

• Molecule 1: Proteasome subunit alpha

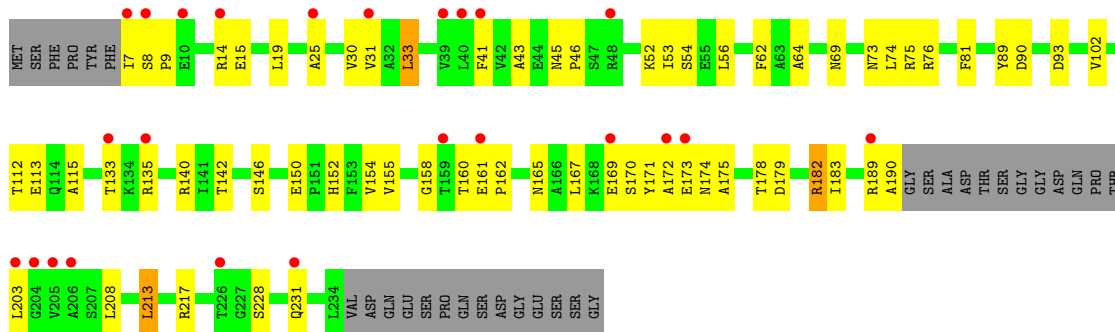

• Molecule 1: Proteasome subunit alpha

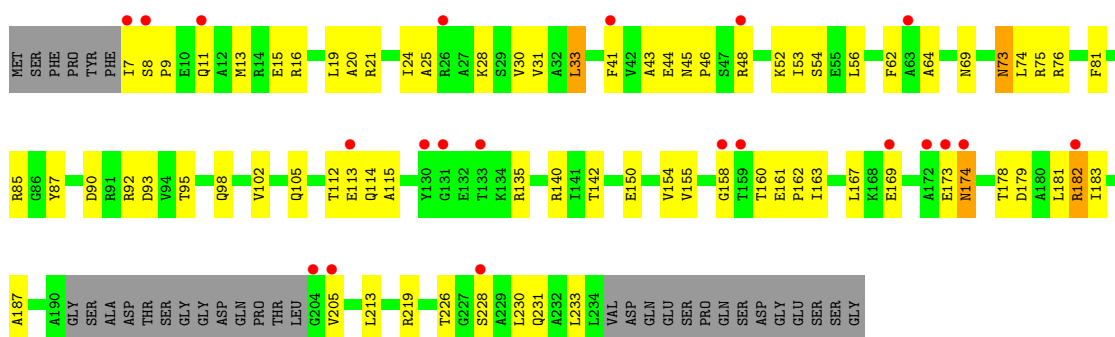

• Molecule 1: Proteasome subunit alpha



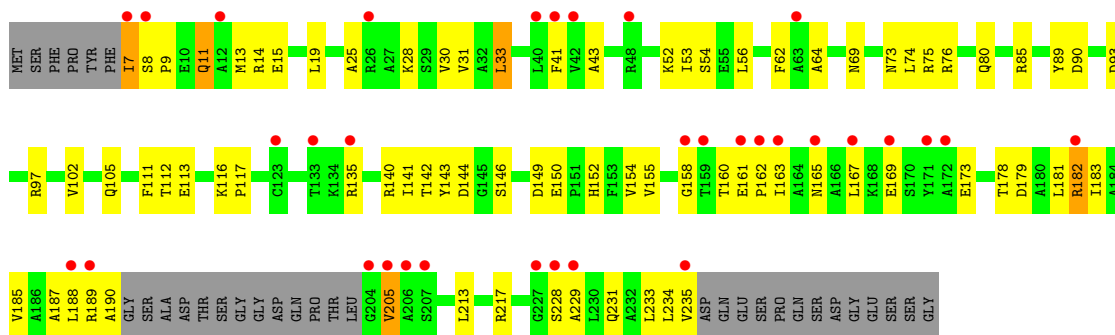

• Molecule 1: Proteasome subunit alpha

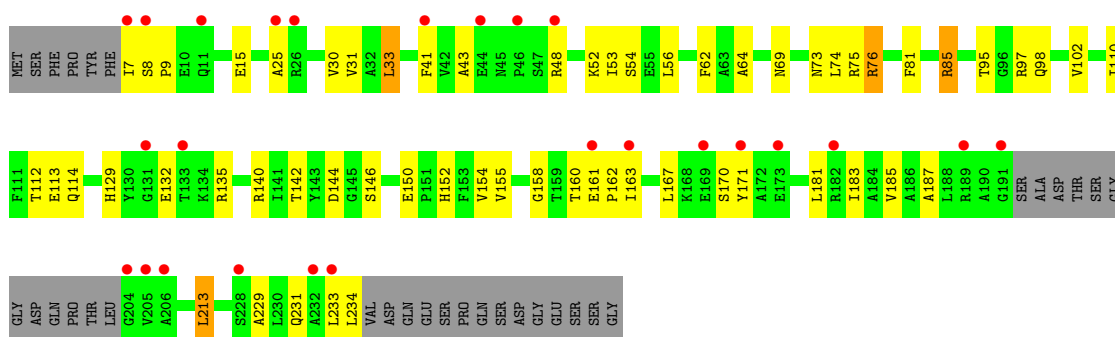

• Molecule 1: Proteasome subunit alpha

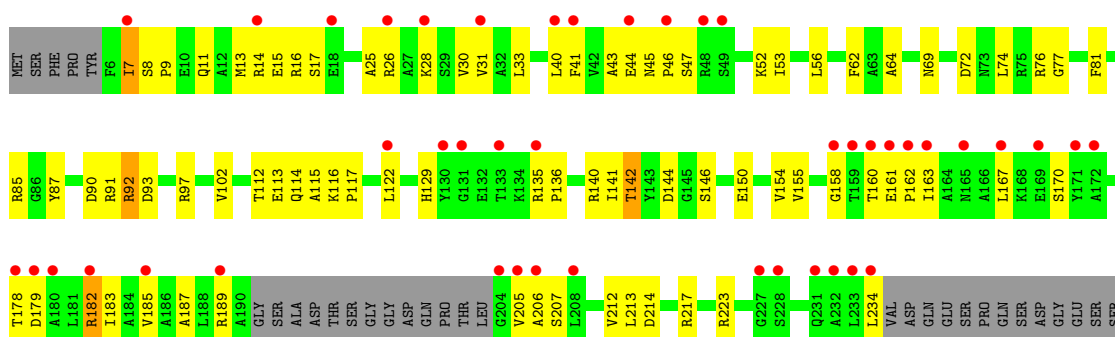

• Molecule 1: Proteasome subunit alpha

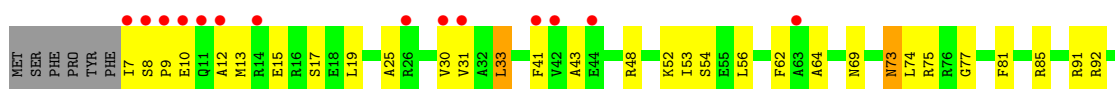

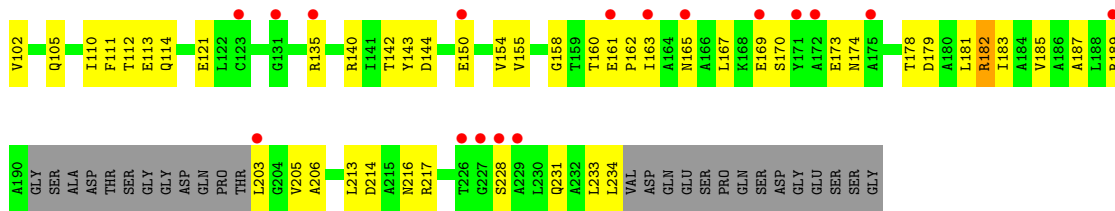

• Molecule 1: Proteasome subunit alpha

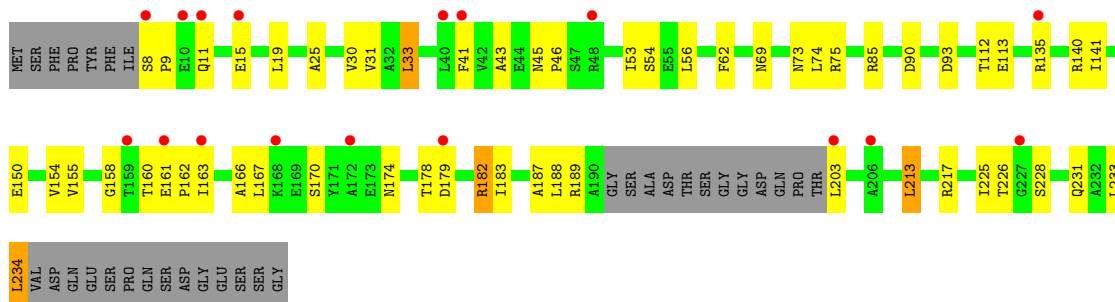

• Molecule 2: Proteasome subunit beta

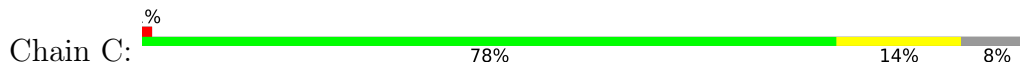

• Molecule 2: Proteasome subunit beta

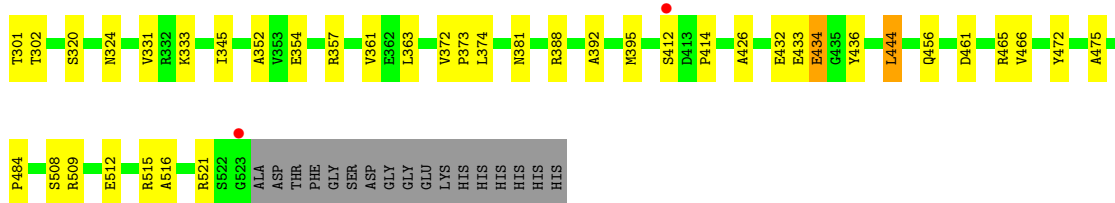
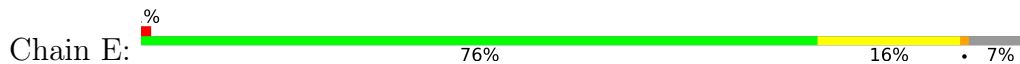

• Molecule 2: Proteasome subunit beta

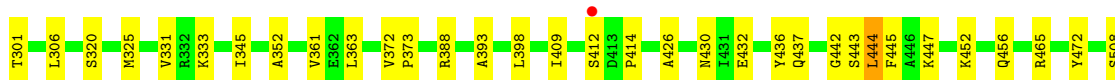
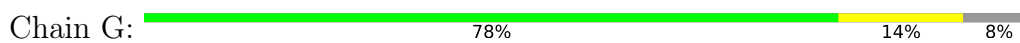

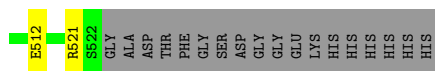

• Molecule 2: Proteasome subunit beta

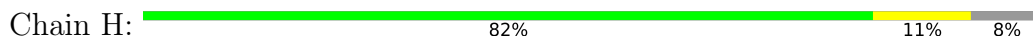

• Molecule 2: Proteasome subunit beta

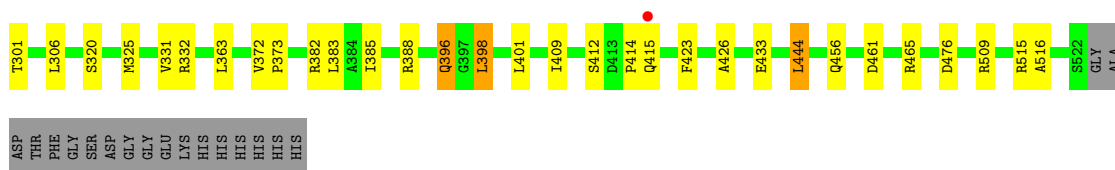
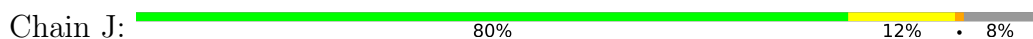

• Molecule 2: Proteasome subunit beta

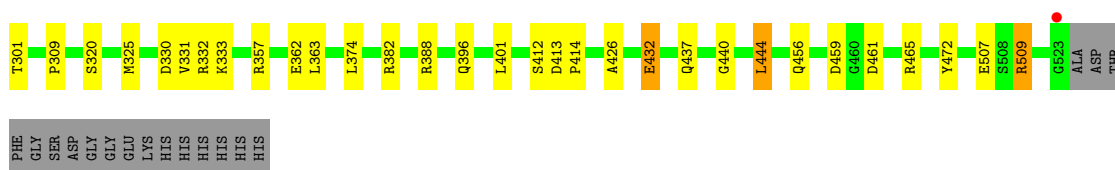
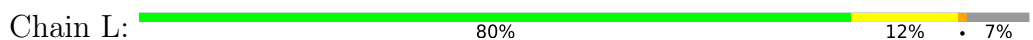

• Molecule 2: Proteasome subunit beta

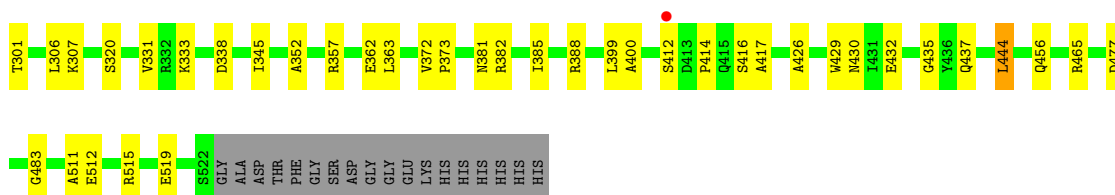

• Molecule 2: Proteasome subunit beta

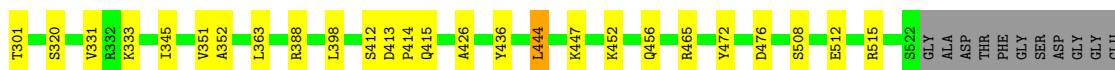
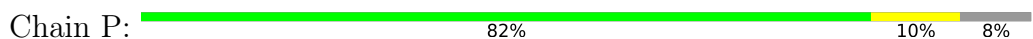

LYS
HIS
HIS
HIS
HIS
HIS
HIS

• Molecule 2: Proteasome subunit beta

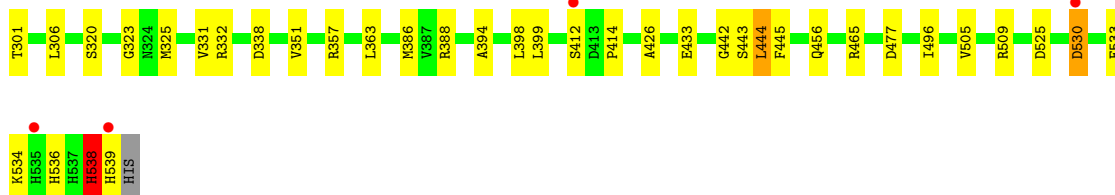
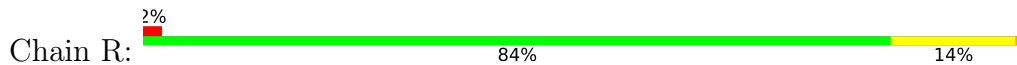

• Molecule 2: Proteasome subunit beta

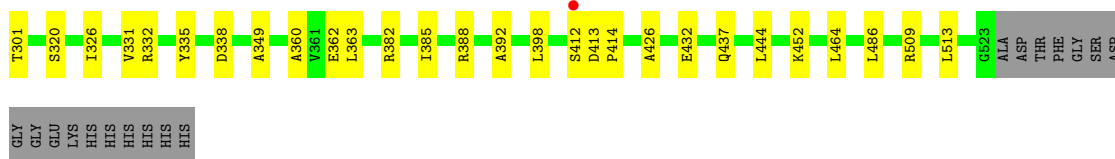
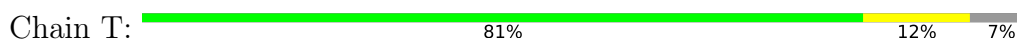

• Molecule 2: Proteasome subunit beta

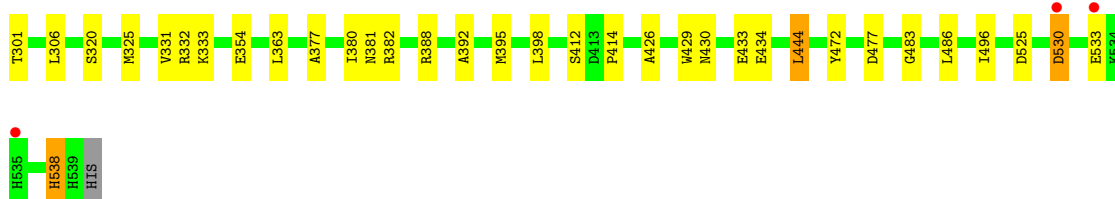
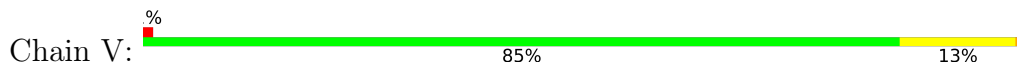

• Molecule 2: Proteasome subunit beta

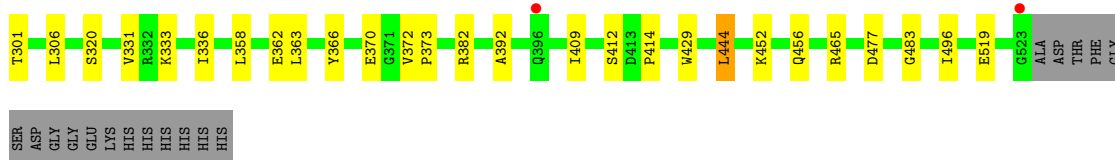
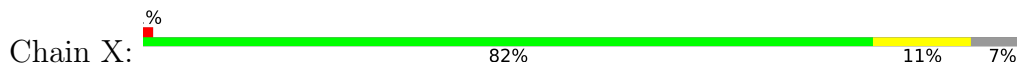

• Molecule 2: Proteasome subunit beta

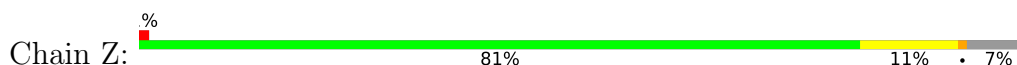

PHE
GLY
SER
ASP
GLY
GLY
GLY
GLU
LYS
HIS
HIS
HIS
HIS
HIS
HIS

● Molecule 2: Proteasome subunit beta

Chain 2:  80% 11% 7%

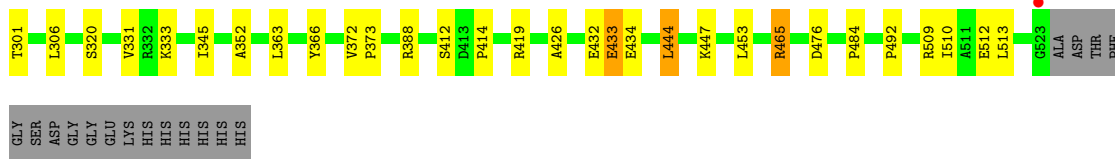

GLY
SER
ASP
GLY
GLY
GLU
LYS
HIS
HIS
HIS
HIS
HIS
HIS

4 Data and refinement statistics

Property	Value	Source
Space group	P 1 21 1	Depositor
Cell constants a, b, c, α , β , γ	170.37Å 118.44Å 195.25Å 90.00° 113.02° 90.00°	Depositor
Resolution (Å)	24.95 – 2.20 25.11 – 2.12	Depositor EDS
% Data completeness (in resolution range)	92.0 (24.95-2.20) 89.2 (25.11-2.12)	Depositor EDS
R_{merge}	0.12	Depositor
R_{sym}	(Not available)	Depositor
$\langle I/\sigma(I) \rangle$ ¹	1.78 (at 2.11Å)	Xtrriage
Refinement program	CNS	Depositor
R, R_{free}	0.205 , 0.234 0.199 , 0.226	Depositor DCC
R_{free} test set	18918 reflections (4.99%)	wwPDB-VP
Wilson B-factor (Å ²)	22.6	Xtrriage
Anisotropy	0.230	Xtrriage
Bulk solvent k_{sol} (e/Å ³), B_{sol} (Å ²)	0.32 , 56.1	EDS
L-test for twinning ²	$\langle L \rangle = 0.49$, $\langle L^2 \rangle = 0.32$	Xtrriage
Estimated twinning fraction	0.008 for h,-k,-h-l	Xtrriage
F_o, F_c correlation	0.94	EDS
Total number of atoms	50080	wwPDB-VP
Average B, all atoms (Å ²)	40.0	wwPDB-VP

Xtrriage's analysis on translational NCS is as follows: *The largest off-origin peak in the Patterson function is 4.53% of the height of the origin peak. No significant pseudotranslation is detected.*

¹Intensities estimated from amplitudes.

²Theoretical values of $\langle |L| \rangle$, $\langle L^2 \rangle$ for acentric reflections are 0.5, 0.333 respectively for untwinned datasets, and 0.375, 0.2 for perfectly twinned datasets.

5 Model quality [i](#)

5.1 Standard geometry [i](#)

Bond lengths and bond angles in the following residue types are not validated in this section: DMF, SA6

The Z score for a bond length (or angle) is the number of standard deviations the observed value is removed from the expected value. A bond length (or angle) with $|Z| > 5$ is considered an outlier worth inspection. RMSZ is the root-mean-square of all Z scores of the bond lengths (or angles).

Mol	Chain	Bond lengths		Bond angles	
		RMSZ	# Z >5	RMSZ	# Z >5
1	1	0.53	0/1683	0.73	1/2274 (0.0%)
1	A	0.49	0/1679	0.72	1/2268 (0.0%)
1	B	0.52	0/1668	0.71	1/2253 (0.0%)
1	D	0.46	0/1675	0.69	1/2263 (0.0%)
1	F	0.51	0/1726	0.74	2/2332 (0.1%)
1	I	0.51	0/1695	0.73	4/2290 (0.2%)
1	K	0.51	0/1691	0.71	1/2285 (0.0%)
1	M	0.51	0/1691	0.74	2/2285 (0.1%)
1	O	0.51	0/1691	0.72	1/2285 (0.0%)
1	Q	0.47	0/1683	0.69	1/2274 (0.0%)
1	S	0.50	0/1690	0.72	2/2284 (0.1%)
1	U	0.49	0/1687	0.71	3/2279 (0.1%)
1	W	0.44	0/1695	0.68	1/2290 (0.0%)
1	Y	0.48	0/1691	0.72	1/2285 (0.0%)
2	2	0.65	0/1666	0.79	0/2259
2	C	0.71	0/1662	0.84	2/2254 (0.1%)
2	E	0.73	0/1666	0.81	0/2259
2	G	0.66	0/1662	0.77	0/2254
2	H	0.70	0/1662	0.79	0/2254
2	J	0.71	0/1662	0.81	0/2254
2	L	0.70	0/1666	0.80	0/2259
2	N	0.69	0/1662	0.81	1/2254 (0.0%)
2	P	0.69	0/1662	0.79	0/2254
2	R	0.71	0/1797	0.81	3/2435 (0.1%)
2	T	0.66	0/1666	0.77	1/2259 (0.0%)
2	V	0.70	0/1797	0.78	1/2435 (0.0%)
2	X	0.64	0/1666	0.78	0/2259
2	Z	0.62	0/1666	0.75	0/2259
All	All	0.60	0/47207	0.76	30/63895 (0.0%)

There are no bond length outliers.

The worst 5 of 30 bond angle outliers are listed below:

Mol	Chain	Res	Type	Atoms	Z	Observed(°)	Ideal(°)
1	Y	213	LEU	N-CA-C	-5.99	94.82	111.00
2	R	338	ASP	CB-CG-OD1	5.80	123.52	118.30
1	M	76	ARG	NE-CZ-NH2	-5.77	117.42	120.30
1	I	213	LEU	N-CA-C	-5.71	95.60	111.00
1	K	213	LEU	N-CA-C	-5.70	95.61	111.00

There are no chirality outliers.

There are no planarity outliers.

5.2 Too-close contacts [i](#)

In the following table, the Non-H and H(model) columns list the number of non-hydrogen atoms and hydrogen atoms in the chain respectively. The H(added) column lists the number of hydrogen atoms added and optimized by MolProbity. The Clashes column lists the number of clashes within the asymmetric unit, whereas Symm-Clashes lists symmetry-related clashes.

Mol	Chain	Non-H	H(model)	H(added)	Clashes	Symm-Clashes
1	1	1658	0	1659	55	0
1	A	1654	0	1651	68	0
1	B	1643	0	1639	82	0
1	D	1650	0	1648	99	0
1	F	1699	0	1696	70	0
1	I	1669	0	1668	96	0
1	K	1666	0	1670	67	0
1	M	1666	0	1670	78	0
1	O	1666	0	1670	67	0
1	Q	1658	0	1659	82	0
1	S	1665	0	1668	86	0
1	U	1662	0	1662	51	0
1	W	1669	0	1668	70	0
1	Y	1666	0	1670	80	0
2	2	1642	0	1632	39	0
2	C	1638	0	1629	33	0
2	E	1642	0	1632	47	0
2	G	1638	0	1629	43	0
2	H	1638	0	1629	33	0
2	J	1638	0	1629	43	0
2	L	1642	0	1632	31	0
2	N	1638	0	1629	44	0
2	P	1638	0	1629	31	0

Continued on next page...

Continued from previous page...

Mol	Chain	Non-H	H(model)	H(added)	Clashes	Symm-Clashes
2	R	1767	0	1729	46	0
2	T	1642	0	1632	21	0
2	V	1767	0	1729	40	0
2	X	1642	0	1632	25	0
2	Z	1642	0	1632	26	0
3	1	5	0	7	0	0
3	2	40	0	56	27	0
3	A	10	0	14	1	0
3	B	10	0	14	2	0
3	C	35	0	49	15	0
3	D	25	0	35	6	0
3	E	30	0	42	16	0
3	F	15	0	21	1	0
3	G	45	0	63	31	0
3	H	30	0	42	12	0
3	I	10	0	14	2	0
3	J	15	0	21	7	0
3	K	20	0	28	11	0
3	L	20	0	28	5	0
3	M	20	0	28	0	0
3	N	25	0	35	26	0
3	O	15	0	21	1	0
3	P	40	0	56	14	0
3	Q	15	0	21	9	0
3	R	25	0	35	13	0
3	S	10	0	14	1	0
3	T	30	0	42	15	0
3	U	10	0	14	8	0
3	V	45	0	63	48	0
3	W	10	0	14	7	0
3	X	25	0	35	7	0
3	Y	15	0	21	4	0
3	Z	20	0	28	8	0
4	2	20	0	22	4	0
4	C	20	0	22	3	0
4	E	20	0	22	3	0
4	G	20	0	22	3	0
4	H	20	0	22	5	0
4	J	20	0	22	2	0
4	L	20	0	22	3	0
4	N	20	0	22	3	0
4	P	20	0	22	4	0

Continued on next page...

Continued from previous page...

Mol	Chain	Non-H	H(model)	H(added)	Clashes	Symm-Clashes
4	R	20	0	22	3	0
4	T	20	0	22	3	0
4	V	20	0	22	4	0
4	X	20	0	22	4	0
4	Z	20	0	22	3	0
5	1	47	0	0	1	0
5	2	143	0	0	7	0
5	A	43	0	0	4	0
5	B	41	0	0	6	0
5	C	163	0	0	10	0
5	D	40	0	0	8	0
5	E	166	0	0	9	0
5	F	58	0	0	5	0
5	G	131	0	0	2	0
5	H	148	0	0	7	0
5	I	52	0	0	10	0
5	J	142	0	0	10	0
5	K	45	0	0	5	0
5	L	153	0	0	12	0
5	M	40	0	0	5	0
5	N	154	0	0	5	0
5	O	47	0	0	5	0
5	P	139	0	0	6	0
5	Q	38	0	0	9	0
5	R	170	0	0	7	0
5	S	42	0	0	8	0
5	T	116	0	0	7	0
5	U	49	0	0	4	0
5	V	177	0	0	14	0
5	W	35	0	0	4	0
5	X	150	0	0	7	0
5	Y	28	0	0	6	0
5	Z	123	0	0	4	0
All	All	50080	0	47491	1521	0

The all-atom clashscore is defined as the number of clashes found per 1000 atoms (including hydrogen atoms). The all-atom clashscore for this structure is 16.

The worst 5 of 1521 close contacts within the same asymmetric unit are listed below, sorted by their clash magnitude.

Atom-1	Atom-2	Interatomic distance (Å)	Clash overlap (Å)
1:B:7:ILE:HG21	1:B:11:GLN:CG	1.63	1.27
1:F:7:ILE:CG2	1:F:11:GLN:HB3	1.65	1.27
3:R:92:DMF:H21	5:R:1869:HOH:O	1.30	1.23
1:O:9:PRO:HD2	1:U:15:GLU:CG	1.69	1.21
1:A:80:GLN:C	1:A:80:GLN:HE21	1.45	1.20

There are no symmetry-related clashes.

5.3 Torsion angles [i](#)

5.3.1 Protein backbone [i](#)

In the following table, the Percentiles column shows the percent Ramachandran outliers of the chain as a percentile score with respect to all X-ray entries followed by that with respect to entries of similar resolution.

The Analysed column shows the number of residues for which the backbone conformation was analysed, and the total number of residues.

Mol	Chain	Analysed	Favoured	Allowed	Outliers	Percentiles	
1	1	211/248 (85%)	199 (94%)	12 (6%)	0	100	100
1	A	211/248 (85%)	203 (96%)	8 (4%)	0	100	100
1	B	209/248 (84%)	201 (96%)	8 (4%)	0	100	100
1	D	210/248 (85%)	201 (96%)	9 (4%)	0	100	100
1	F	216/248 (87%)	209 (97%)	6 (3%)	1 (0%)	29	31
1	I	212/248 (86%)	201 (95%)	11 (5%)	0	100	100
1	K	212/248 (86%)	202 (95%)	10 (5%)	0	100	100
1	M	212/248 (86%)	201 (95%)	11 (5%)	0	100	100
1	O	212/248 (86%)	199 (94%)	13 (6%)	0	100	100
1	Q	211/248 (85%)	198 (94%)	13 (6%)	0	100	100
1	S	212/248 (86%)	203 (96%)	9 (4%)	0	100	100
1	U	212/248 (86%)	200 (94%)	12 (6%)	0	100	100
1	W	212/248 (86%)	199 (94%)	13 (6%)	0	100	100
1	Y	212/248 (86%)	202 (95%)	10 (5%)	0	100	100
2	2	221/240 (92%)	220 (100%)	1 (0%)	0	100	100
2	C	220/240 (92%)	219 (100%)	1 (0%)	0	100	100

Continued on next page...

Continued from previous page...

Mol	Chain	Analysed	Favoured	Allowed	Outliers	Percentiles	
2	E	221/240 (92%)	219 (99%)	2 (1%)	0	100	100
2	G	220/240 (92%)	218 (99%)	2 (1%)	0	100	100
2	H	220/240 (92%)	219 (100%)	1 (0%)	0	100	100
2	J	220/240 (92%)	219 (100%)	1 (0%)	0	100	100
2	L	221/240 (92%)	218 (99%)	3 (1%)	0	100	100
2	N	220/240 (92%)	218 (99%)	2 (1%)	0	100	100
2	P	220/240 (92%)	218 (99%)	2 (1%)	0	100	100
2	R	237/240 (99%)	236 (100%)	1 (0%)	0	100	100
2	T	221/240 (92%)	220 (100%)	1 (0%)	0	100	100
2	V	237/240 (99%)	234 (99%)	3 (1%)	0	100	100
2	X	221/240 (92%)	219 (99%)	2 (1%)	0	100	100
2	Z	221/240 (92%)	218 (99%)	3 (1%)	0	100	100
All	All	6084/6832 (89%)	5913 (97%)	170 (3%)	1 (0%)	100	100

All (1) Ramachandran outliers are listed below:

Mol	Chain	Res	Type
1	F	191	GLY

5.3.2 Protein sidechains [i](#)

In the following table, the Percentiles column shows the percent sidechain outliers of the chain as a percentile score with respect to all X-ray entries followed by that with respect to entries of similar resolution.

The Analysed column shows the number of residues for which the sidechain conformation was analysed, and the total number of residues.

Mol	Chain	Analysed	Rotameric	Outliers	Percentiles	
1	1	165/192 (86%)	158 (96%)	7 (4%)	30	38
1	A	164/192 (85%)	155 (94%)	9 (6%)	21	26
1	B	163/192 (85%)	154 (94%)	9 (6%)	21	26
1	D	164/192 (85%)	152 (93%)	12 (7%)	14	15
1	F	169/192 (88%)	161 (95%)	8 (5%)	26	33
1	I	166/192 (86%)	161 (97%)	5 (3%)	41	53

Continued on next page...

Continued from previous page...

Mol	Chain	Analysed	Rotameric	Outliers	Percentiles	
1	K	166/192 (86%)	157 (95%)	9 (5%)	22	26
1	M	166/192 (86%)	155 (93%)	11 (7%)	16	19
1	O	166/192 (86%)	161 (97%)	5 (3%)	41	53
1	Q	165/192 (86%)	158 (96%)	7 (4%)	30	38
1	S	166/192 (86%)	158 (95%)	8 (5%)	25	32
1	U	165/192 (86%)	160 (97%)	5 (3%)	41	53
1	W	166/192 (86%)	160 (96%)	6 (4%)	35	45
1	Y	166/192 (86%)	159 (96%)	7 (4%)	30	38
2	2	165/178 (93%)	160 (97%)	5 (3%)	41	53
2	C	165/178 (93%)	163 (99%)	2 (1%)	71	83
2	E	165/178 (93%)	161 (98%)	4 (2%)	49	62
2	G	165/178 (93%)	163 (99%)	2 (1%)	71	83
2	H	165/178 (93%)	162 (98%)	3 (2%)	59	72
2	J	165/178 (93%)	161 (98%)	4 (2%)	49	62
2	L	165/178 (93%)	160 (97%)	5 (3%)	41	53
2	N	165/178 (93%)	162 (98%)	3 (2%)	59	72
2	P	165/178 (93%)	163 (99%)	2 (1%)	71	83
2	R	177/178 (99%)	173 (98%)	4 (2%)	50	63
2	T	165/178 (93%)	160 (97%)	5 (3%)	41	53
2	V	177/178 (99%)	173 (98%)	4 (2%)	50	63
2	X	165/178 (93%)	162 (98%)	3 (2%)	59	72
2	Z	165/178 (93%)	162 (98%)	3 (2%)	59	72
All	All	4651/5180 (90%)	4494 (97%)	157 (3%)	37	47

5 of 157 residues with a non-rotameric sidechain are listed below:

Mol	Chain	Res	Type
2	T	486	LEU
2	Z	444	LEU
1	U	69	ASN
1	W	142	THR
1	1	182	ARG

Sometimes sidechains can be flipped to improve hydrogen bonding and reduce clashes. 5 of 92 such sidechains are listed below:

Mol	Chain	Res	Type
2	R	538	HIS
2	V	456	GLN
1	S	73	ASN
1	U	69	ASN
1	W	114	GLN

5.3.3 RNA [i](#)

There are no RNA molecules in this entry.

5.4 Non-standard residues in protein, DNA, RNA chains [i](#)

There are no non-standard protein/DNA/RNA residues in this entry.

5.5 Carbohydrates [i](#)

There are no monosaccharides in this entry.

5.6 Ligand geometry [i](#)

137 ligands are modelled in this entry.

In the following table, the Counts columns list the number of bonds (or angles) for which Mogul statistics could be retrieved, the number of bonds (or angles) that are observed in the model and the number of bonds (or angles) that are defined in the Chemical Component Dictionary. The Link column lists molecule types, if any, to which the group is linked. The Z score for a bond length (or angle) is the number of standard deviations the observed value is removed from the expected value. A bond length (or angle) with $|Z| > 2$ is considered an outlier worth inspection. RMSZ is the root-mean-square of all Z scores of the bond lengths (or angles).

Mol	Type	Chain	Res	Link	Bond lengths			Bond angles		
					Counts	RMSZ	$\# Z > 2$	Counts	RMSZ	$\# Z > 2$
3	DMF	Y	251	-	4,4,4	0.30	0	4,4,4	0.41	0
3	DMF	T	115	-	4,4,4	0.31	0	4,4,4	0.48	0
3	DMF	J	45	-	4,4,4	0.29	0	4,4,4	0.31	0
3	DMF	R	89	-	4,4,4	0.40	0	4,4,4	0.67	0
3	DMF	H	117	-	4,4,4	0.40	0	4,4,4	0.78	0
4	SA6	J	300	2	17,21,21	3.20	9 (52%)	23,32,32	1.48	3 (13%)
3	DMF	V	39	-	4,4,4	0.32	0	4,4,4	0.37	0
3	DMF	V	32	-	4,4,4	0.31	0	4,4,4	0.47	0
3	DMF	G	64	-	4,4,4	0.31	0	4,4,4	0.37	0
3	DMF	T	102	-	4,4,4	0.16	0	4,4,4	0.13	0

Mol	Type	Chain	Res	Link	Bond lengths			Bond angles		
					Counts	RMSZ	# Z > 2	Counts	RMSZ	# Z > 2
3	DMF	2	49	-	4,4,4	0.24	0	4,4,4	0.48	0
3	DMF	R	80	-	4,4,4	0.29	0	4,4,4	0.37	0
3	DMF	V	83	-	4,4,4	0.24	0	4,4,4	0.42	0
3	DMF	P	14	-	4,4,4	0.27	0	4,4,4	0.41	0
3	DMF	Z	114	-	4,4,4	0.33	0	4,4,4	0.45	0
3	DMF	O	250	-	4,4,4	0.34	0	4,4,4	0.38	0
4	SA6	X	300	2	17,21,21	3.06	9 (52%)	23,32,32	1.58	2 (8%)
3	DMF	C	88	-	4,4,4	0.32	0	4,4,4	0.48	0
3	DMF	P	107	-	4,4,4	0.23	0	4,4,4	0.44	0
4	SA6	V	300	2	17,21,21	3.05	8 (47%)	23,32,32	1.37	3 (13%)
3	DMF	K	251	-	4,4,4	0.31	0	4,4,4	0.17	0
3	DMF	1	249	-	4,4,4	0.29	0	4,4,4	0.36	0
3	DMF	E	75	-	4,4,4	0.27	0	4,4,4	0.41	0
3	DMF	E	20	-	4,4,4	0.30	0	4,4,4	0.44	0
3	DMF	X	15	-	4,4,4	0.31	0	4,4,4	0.45	0
3	DMF	D	250	-	4,4,4	0.33	0	4,4,4	0.39	0
3	DMF	I	250	-	4,4,4	0.27	0	4,4,4	0.33	0
3	DMF	V	116	-	4,4,4	0.44	0	4,4,4	1.03	0
3	DMF	O	249	-	4,4,4	0.25	0	4,4,4	0.51	0
3	DMF	P	86	-	4,4,4	0.29	0	4,4,4	0.40	0
3	DMF	Z	18	-	4,4,4	0.23	0	4,4,4	0.42	0
3	DMF	G	77	-	4,4,4	0.44	0	4,4,4	0.41	0
3	DMF	H	72	-	4,4,4	0.31	0	4,4,4	0.40	0
3	DMF	P	2	-	4,4,4	0.27	0	4,4,4	0.52	0
3	DMF	C	47	-	4,4,4	0.55	0	4,4,4	0.23	0
3	DMF	H	71	-	4,4,4	0.50	0	4,4,4	0.37	0
3	DMF	2	112	-	4,4,4	0.18	0	4,4,4	0.38	0
3	DMF	M	249	-	4,4,4	0.30	0	4,4,4	0.42	0
3	DMF	N	90	-	4,4,4	0.30	0	4,4,4	0.44	0
3	DMF	C	38	-	4,4,4	0.17	0	4,4,4	0.51	0
3	DMF	W	249	-	4,4,4	0.30	0	4,4,4	0.40	0
3	DMF	S	249	-	4,4,4	0.28	0	4,4,4	0.36	0
3	DMF	J	123	-	4,4,4	0.30	0	4,4,4	0.40	0
3	DMF	2	4	-	4,4,4	0.31	0	4,4,4	0.45	0
3	DMF	A	250	-	4,4,4	0.47	0	4,4,4	0.50	0
3	DMF	Y	250	-	4,4,4	0.66	0	4,4,4	0.32	0
3	DMF	W	250	-	4,4,4	0.29	0	4,4,4	0.44	0
3	DMF	S	250	-	4,4,4	0.68	0	4,4,4	0.35	0
3	DMF	J	110	-	4,4,4	0.34	0	4,4,4	0.58	0
3	DMF	2	101	-	4,4,4	0.33	0	4,4,4	0.41	0
4	SA6	T	300	2	17,21,21	3.12	7 (41%)	23,32,32	1.75	4 (17%)
3	DMF	D	252	-	4,4,4	0.29	0	4,4,4	0.38	0

Mol	Type	Chain	Res	Link	Bond lengths			Bond angles		
					Counts	RMSZ	# Z > 2	Counts	RMSZ	# Z > 2
3	DMF	E	100	-	4,4,4	0.30	0	4,4,4	0.46	0
3	DMF	G	12	-	4,4,4	0.29	0	4,4,4	0.42	0
3	DMF	H	91	-	4,4,4	0.28	0	4,4,4	0.45	0
4	SA6	G	300	2	17,21,21	2.98	7 (41%)	23,32,32	1.46	3 (13%)
3	DMF	N	93	-	4,4,4	0.32	0	4,4,4	0.39	0
3	DMF	T	113	-	4,4,4	0.24	0	4,4,4	0.42	0
3	DMF	B	250	-	4,4,4	0.29	0	4,4,4	0.34	0
3	DMF	P	56	-	4,4,4	0.30	0	4,4,4	0.44	0
3	DMF	C	69	-	4,4,4	0.28	0	4,4,4	0.45	0
3	DMF	K	252	-	4,4,4	0.28	0	4,4,4	0.36	0
3	DMF	T	10	-	4,4,4	0.34	0	4,4,4	0.50	0
3	DMF	U	250	-	4,4,4	0.68	0	4,4,4	0.32	0
4	SA6	Z	300	2	17,21,21	3.30	11 (64%)	23,32,32	1.49	3 (13%)
3	DMF	H	66	-	4,4,4	0.30	0	4,4,4	0.42	0
3	DMF	P	51	-	4,4,4	0.25	0	4,4,4	0.35	0
3	DMF	C	121	-	4,4,4	0.30	0	4,4,4	0.42	0
3	DMF	I	249	-	4,4,4	0.31	0	4,4,4	0.39	0
3	DMF	D	251	-	4,4,4	0.30	0	4,4,4	0.41	0
3	DMF	F	250	-	4,4,4	0.29	0	4,4,4	0.35	0
3	DMF	Z	54	-	4,4,4	0.34	0	4,4,4	0.47	0
3	DMF	R	92	-	4,4,4	0.29	0	4,4,4	0.40	0
3	DMF	K	250	-	4,4,4	0.27	0	4,4,4	0.33	0
3	DMF	L	97	-	4,4,4	0.29	0	4,4,4	0.43	0
3	DMF	M	252	-	4,4,4	0.32	0	4,4,4	0.37	0
3	DMF	G	24	-	4,4,4	0.30	0	4,4,4	0.40	0
3	DMF	V	27	-	4,4,4	0.30	0	4,4,4	0.34	0
3	DMF	2	57	-	4,4,4	0.30	0	4,4,4	0.32	0
3	DMF	X	16	-	4,4,4	0.28	0	4,4,4	0.39	0
3	DMF	Q	250	-	4,4,4	0.27	0	4,4,4	0.53	0
3	DMF	G	70	-	4,4,4	0.71	0	4,4,4	0.30	0
3	DMF	Y	249	-	4,4,4	0.31	0	4,4,4	0.42	0
3	DMF	K	249	-	4,4,4	0.28	0	4,4,4	0.39	0
3	DMF	F	249	-	4,4,4	0.27	0	4,4,4	0.37	0
4	SA6	C	300	2	17,21,21	2.76	6 (35%)	23,32,32	1.85	6 (26%)
3	DMF	N	104	-	4,4,4	0.33	0	4,4,4	0.39	0
3	DMF	R	59	-	4,4,4	0.31	0	4,4,4	0.40	0
4	SA6	R	300	2	17,21,21	3.53	7 (41%)	23,32,32	1.69	4 (17%)
4	SA6	L	300	2	17,21,21	3.25	8 (47%)	23,32,32	1.83	6 (26%)
3	DMF	V	120	-	4,4,4	0.34	0	4,4,4	0.43	0
3	DMF	P	33	-	4,4,4	0.27	0	4,4,4	0.25	0
3	DMF	V	42	-	4,4,4	0.29	0	4,4,4	0.47	0
3	DMF	X	122	-	4,4,4	0.30	0	4,4,4	0.34	0

Mol	Type	Chain	Res	Link	Bond lengths			Bond angles		
					Counts	RMSZ	# Z > 2	Counts	RMSZ	# Z > 2
3	DMF	Q	251	-	4,4,4	0.31	0	4,4,4	0.34	0
3	DMF	P	60	-	4,4,4	0.28	0	4,4,4	0.39	0
3	DMF	L	36	-	4,4,4	0.32	0	4,4,4	0.46	0
3	DMF	G	62	-	4,4,4	0.30	0	4,4,4	0.41	0
3	DMF	2	108	-	4,4,4	0.31	0	4,4,4	0.43	0
3	DMF	N	118	-	4,4,4	0.37	0	4,4,4	0.65	0
4	SA6	H	300	2	17,21,21	3.02	9 (52%)	23,32,32	1.54	4 (17%)
3	DMF	H	43	-	4,4,4	0.36	0	4,4,4	0.72	0
3	DMF	E	28	-	4,4,4	0.29	0	4,4,4	0.21	0
3	DMF	M	251	-	4,4,4	0.31	0	4,4,4	0.32	0
3	DMF	2	52	-	4,4,4	0.32	0	4,4,4	0.42	0
3	DMF	G	98	-	4,4,4	0.31	0	4,4,4	0.41	0
3	DMF	G	119	-	4,4,4	0.28	0	4,4,4	0.35	0
3	DMF	D	249	-	4,4,4	0.58	0	4,4,4	0.35	0
3	DMF	X	40	-	4,4,4	0.31	0	4,4,4	0.40	0
3	DMF	T	84	-	4,4,4	0.08	0	4,4,4	0.15	0
3	DMF	L	81	-	4,4,4	0.29	0	4,4,4	0.33	0
3	DMF	C	103	-	4,4,4	0.31	0	4,4,4	0.35	0
4	SA6	2	300	2	17,21,21	2.40	5 (29%)	23,32,32	1.78	6 (26%)
3	DMF	Q	249	-	4,4,4	0.30	0	4,4,4	0.40	0
3	DMF	U	249	-	4,4,4	0.28	0	4,4,4	0.33	0
3	DMF	T	29	-	4,4,4	0.29	0	4,4,4	0.39	0
4	SA6	N	300	2	17,21,21	2.65	7 (41%)	23,32,32	1.66	5 (21%)
3	DMF	R	95	-	4,4,4	0.34	0	4,4,4	0.38	0
3	DMF	F	251	-	4,4,4	0.20	0	4,4,4	0.38	0
3	DMF	D	253	-	4,4,4	0.26	0	4,4,4	0.32	0
3	DMF	X	41	-	4,4,4	0.54	0	4,4,4	0.34	0
3	DMF	O	251	-	4,4,4	0.40	0	4,4,4	0.78	0
3	DMF	2	87	-	4,4,4	0.30	0	4,4,4	0.43	0
3	DMF	V	109	-	4,4,4	0.22	0	4,4,4	0.31	0
3	DMF	A	249	-	4,4,4	0.58	0	4,4,4	0.27	0
3	DMF	C	63	-	4,4,4	0.28	0	4,4,4	0.50	0
3	DMF	V	82	-	4,4,4	0.34	0	4,4,4	0.41	0
3	DMF	Z	94	-	4,4,4	0.27	0	4,4,4	0.38	0
4	SA6	P	300	2	17,21,21	2.83	7 (41%)	23,32,32	1.65	4 (17%)
3	DMF	B	249	-	4,4,4	0.28	0	4,4,4	0.41	0
3	DMF	E	73	-	4,4,4	0.28	0	4,4,4	0.42	0
4	SA6	E	300	2	17,21,21	2.81	8 (47%)	23,32,32	1.73	5 (21%)
3	DMF	L	50	-	4,4,4	0.23	0	4,4,4	0.28	0
3	DMF	N	22	-	4,4,4	0.31	0	4,4,4	0.35	0
3	DMF	G	111	-	4,4,4	0.25	0	4,4,4	0.34	0
3	DMF	M	250	-	4,4,4	0.31	0	4,4,4	0.35	0

Mol	Type	Chain	Res	Link	Bond lengths			Bond angles		
					Counts	RMSZ	# Z > 2	Counts	RMSZ	# Z > 2
3	DMF	E	53	-	4,4,4	0.29	0	4,4,4	0.39	0

In the following table, the Chirals column lists the number of chiral outliers, the number of chiral centers analysed, the number of these observed in the model and the number defined in the Chemical Component Dictionary. Similar counts are reported in the Torsion and Rings columns. '-' means no outliers of that kind were identified.

Mol	Type	Chain	Res	Link	Chirals	Torsions	Rings
3	DMF	Y	251	-	-	2/2/2/2	-
3	DMF	T	115	-	-	2/2/2/2	-
3	DMF	J	45	-	-	0/2/2/2	-
3	DMF	R	89	-	-	0/2/2/2	-
3	DMF	H	117	-	-	2/2/2/2	-
4	SA6	J	300	2	-	0/6/47/47	0/2/2/2
3	DMF	V	39	-	-	2/2/2/2	-
3	DMF	V	32	-	-	2/2/2/2	-
3	DMF	G	64	-	-	2/2/2/2	-
3	DMF	T	102	-	-	0/2/2/2	-
3	DMF	2	49	-	-	0/2/2/2	-
3	DMF	R	80	-	-	2/2/2/2	-
3	DMF	V	83	-	-	0/2/2/2	-
3	DMF	P	14	-	-	2/2/2/2	-
3	DMF	Z	114	-	-	0/2/2/2	-
3	DMF	O	250	-	-	0/2/2/2	-
4	SA6	X	300	2	-	0/6/47/47	0/2/2/2
3	DMF	C	88	-	-	2/2/2/2	-
3	DMF	P	107	-	-	2/2/2/2	-
4	SA6	V	300	2	-	0/6/47/47	0/2/2/2
3	DMF	K	251	-	-	2/2/2/2	-
3	DMF	1	249	-	-	0/2/2/2	-
3	DMF	E	75	-	-	2/2/2/2	-
3	DMF	E	20	-	-	2/2/2/2	-
3	DMF	X	15	-	-	2/2/2/2	-
3	DMF	D	250	-	-	2/2/2/2	-
3	DMF	I	250	-	-	0/2/2/2	-
3	DMF	V	116	-	-	0/2/2/2	-
3	DMF	O	249	-	-	2/2/2/2	-
3	DMF	P	86	-	-	2/2/2/2	-
3	DMF	Z	18	-	-	2/2/2/2	-

Continued on next page...

Continued from previous page...

Mol	Type	Chain	Res	Link	Chirals	Torsions	Rings
3	DMF	G	77	-	-	0/2/2/2	-
3	DMF	H	72	-	-	1/2/2/2	-
3	DMF	P	2	-	-	2/2/2/2	-
3	DMF	C	47	-	-	0/2/2/2	-
3	DMF	H	71	-	-	0/2/2/2	-
3	DMF	2	112	-	-	2/2/2/2	-
3	DMF	M	249	-	-	0/2/2/2	-
3	DMF	N	90	-	-	2/2/2/2	-
3	DMF	C	38	-	-	2/2/2/2	-
3	DMF	W	249	-	-	2/2/2/2	-
3	DMF	S	249	-	-	2/2/2/2	-
3	DMF	J	123	-	-	0/2/2/2	-
3	DMF	2	4	-	-	0/2/2/2	-
3	DMF	A	250	-	-	0/2/2/2	-
3	DMF	Y	250	-	-	0/2/2/2	-
3	DMF	W	250	-	-	2/2/2/2	-
3	DMF	S	250	-	-	0/2/2/2	-
3	DMF	J	110	-	-	2/2/2/2	-
3	DMF	2	101	-	-	2/2/2/2	-
4	SA6	T	300	2	-	0/6/47/47	0/2/2/2
3	DMF	D	252	-	-	2/2/2/2	-
3	DMF	E	100	-	-	2/2/2/2	-
3	DMF	G	12	-	-	2/2/2/2	-
3	DMF	H	91	-	-	2/2/2/2	-
4	SA6	G	300	2	-	1/6/47/47	0/2/2/2
3	DMF	N	93	-	-	2/2/2/2	-
3	DMF	T	113	-	-	2/2/2/2	-
3	DMF	B	250	-	-	2/2/2/2	-
3	DMF	P	56	-	-	2/2/2/2	-
3	DMF	C	69	-	-	2/2/2/2	-
3	DMF	K	252	-	-	2/2/2/2	-
3	DMF	T	10	-	-	2/2/2/2	-
3	DMF	U	250	-	-	0/2/2/2	-
4	SA6	Z	300	2	-	0/6/47/47	0/2/2/2
3	DMF	H	66	-	-	2/2/2/2	-
3	DMF	P	51	-	-	2/2/2/2	-
3	DMF	C	121	-	-	2/2/2/2	-

Continued on next page...

Continued from previous page...

Mol	Type	Chain	Res	Link	Chirals	Torsions	Rings
3	DMF	I	249	-	-	2/2/2/2	-
3	DMF	D	251	-	-	2/2/2/2	-
3	DMF	F	250	-	-	2/2/2/2	-
3	DMF	Z	54	-	-	2/2/2/2	-
3	DMF	R	92	-	-	0/2/2/2	-
3	DMF	K	250	-	-	2/2/2/2	-
3	DMF	L	97	-	-	2/2/2/2	-
3	DMF	M	252	-	-	2/2/2/2	-
3	DMF	G	24	-	-	0/2/2/2	-
3	DMF	V	27	-	-	2/2/2/2	-
3	DMF	2	57	-	-	0/2/2/2	-
3	DMF	X	16	-	-	2/2/2/2	-
3	DMF	Q	250	-	-	2/2/2/2	-
3	DMF	G	70	-	-	0/2/2/2	-
3	DMF	Y	249	-	-	2/2/2/2	-
3	DMF	K	249	-	-	1/2/2/2	-
3	DMF	F	249	-	-	0/2/2/2	-
4	SA6	C	300	2	-	1/6/47/47	0/2/2/2
3	DMF	N	104	-	-	1/2/2/2	-
3	DMF	R	59	-	-	0/2/2/2	-
4	SA6	R	300	2	-	1/6/47/47	0/2/2/2
4	SA6	L	300	2	-	2/6/47/47	0/2/2/2
3	DMF	V	120	-	-	2/2/2/2	-
3	DMF	P	33	-	-	1/2/2/2	-
3	DMF	V	42	-	-	2/2/2/2	-
3	DMF	X	122	-	-	0/2/2/2	-
3	DMF	Q	251	-	-	2/2/2/2	-
3	DMF	P	60	-	-	2/2/2/2	-
3	DMF	L	36	-	-	2/2/2/2	-
3	DMF	G	62	-	-	2/2/2/2	-
3	DMF	2	108	-	-	0/2/2/2	-
3	DMF	N	118	-	-	2/2/2/2	-
4	SA6	H	300	2	-	1/6/47/47	0/2/2/2
3	DMF	H	43	-	-	2/2/2/2	-
3	DMF	E	28	-	-	2/2/2/2	-
3	DMF	M	251	-	-	2/2/2/2	-
3	DMF	2	52	-	-	2/2/2/2	-

Continued on next page...

Continued from previous page...

Mol	Type	Chain	Res	Link	Chirals	Torsions	Rings
3	DMF	G	98	-	-	0/2/2/2	-
3	DMF	G	119	-	-	2/2/2/2	-
3	DMF	D	249	-	-	0/2/2/2	-
3	DMF	X	40	-	-	0/2/2/2	-
3	DMF	T	84	-	-	2/2/2/2	-
3	DMF	L	81	-	-	0/2/2/2	-
3	DMF	C	103	-	-	2/2/2/2	-
4	SA6	2	300	2	-	1/6/47/47	0/2/2/2
3	DMF	Q	249	-	-	0/2/2/2	-
3	DMF	U	249	-	-	2/2/2/2	-
3	DMF	T	29	-	-	2/2/2/2	-
4	SA6	N	300	2	-	1/6/47/47	0/2/2/2
3	DMF	R	95	-	-	2/2/2/2	-
3	DMF	F	251	-	-	2/2/2/2	-
3	DMF	D	253	-	-	2/2/2/2	-
3	DMF	X	41	-	-	0/2/2/2	-
3	DMF	O	251	-	-	2/2/2/2	-
3	DMF	2	87	-	-	2/2/2/2	-
3	DMF	V	109	-	-	0/2/2/2	-
3	DMF	A	249	-	-	0/2/2/2	-
3	DMF	C	63	-	-	2/2/2/2	-
3	DMF	V	82	-	-	0/2/2/2	-
3	DMF	Z	94	-	-	2/2/2/2	-
4	SA6	P	300	2	-	0/6/47/47	0/2/2/2
3	DMF	B	249	-	-	0/2/2/2	-
3	DMF	E	73	-	-	2/2/2/2	-
4	SA6	E	300	2	-	1/6/47/47	0/2/2/2
3	DMF	L	50	-	-	0/2/2/2	-
3	DMF	N	22	-	-	2/2/2/2	-
3	DMF	G	111	-	-	2/2/2/2	-
3	DMF	M	250	-	-	2/2/2/2	-
3	DMF	E	53	-	-	0/2/2/2	-

The worst 5 of 108 bond length outliers are listed below:

Mol	Chain	Res	Type	Atoms	Z	Observed(Å)	Ideal(Å)
4	R	300	SA6	C5-C4	8.28	1.62	1.52
4	T	300	SA6	C5-C4	7.72	1.61	1.52
4	Z	300	SA6	C5-C4	7.34	1.61	1.52

Continued on next page...

Continued from previous page...

Mol	Chain	Res	Type	Atoms	Z	Observed(Å)	Ideal(Å)
4	H	300	SA6	C5-C4	7.14	1.61	1.52
4	L	300	SA6	C5-C4	7.06	1.61	1.52

The worst 5 of 58 bond angle outliers are listed below:

Mol	Chain	Res	Type	Atoms	Z	Observed(°)	Ideal(°)
4	X	300	SA6	C4-C3-C7	-5.24	99.79	104.23
4	T	300	SA6	C4-C3-C7	-5.06	99.95	104.23
4	R	300	SA6	C4-C3-C7	-4.61	100.32	104.23
4	C	300	SA6	C4-C3-C7	-4.60	100.34	104.23
4	P	300	SA6	C4-C3-C7	-4.58	100.35	104.23

There are no chirality outliers.

5 of 171 torsion outliers are listed below:

Mol	Chain	Res	Type	Atoms
4	C	300	SA6	C1-C2-C3-C4
4	E	300	SA6	C1-C2-C3-C4
4	G	300	SA6	C1-C2-C3-C4
4	L	300	SA6	C1-C2-C3-C4
4	N	300	SA6	C1-C2-C3-C4

There are no ring outliers.

105 monomers are involved in 314 short contacts:

Mol	Chain	Res	Type	Clashes	Symm-Clashes
3	Y	251	DMF	2	0
3	T	115	DMF	1	0
3	J	45	DMF	1	0
3	H	117	DMF	2	0
4	J	300	SA6	2	0
3	V	39	DMF	1	0
3	V	32	DMF	5	0
3	G	64	DMF	9	0
3	T	102	DMF	3	0
3	2	49	DMF	1	0
3	R	80	DMF	1	0
3	V	83	DMF	11	0
3	P	14	DMF	5	0
3	O	250	DMF	1	0
4	X	300	SA6	4	0

Continued on next page...

Continued from previous page...

Mol	Chain	Res	Type	Clashes	Symm-Clashes
3	C	88	DMF	1	0
3	P	107	DMF	5	0
4	V	300	SA6	4	0
3	K	251	DMF	3	0
3	E	75	DMF	4	0
3	E	20	DMF	4	0
3	X	15	DMF	1	0
3	I	250	DMF	2	0
3	V	116	DMF	6	0
3	Z	18	DMF	2	0
3	P	2	DMF	1	0
3	C	47	DMF	1	0
3	H	71	DMF	1	0
3	2	112	DMF	7	0
3	N	90	DMF	7	0
3	C	38	DMF	3	0
3	W	249	DMF	2	0
3	S	249	DMF	1	0
3	J	123	DMF	6	0
3	2	4	DMF	8	0
3	Y	250	DMF	1	0
3	W	250	DMF	5	0
3	2	101	DMF	2	0
4	T	300	SA6	3	0
3	E	100	DMF	2	0
3	G	12	DMF	4	0
3	H	91	DMF	2	0
4	G	300	SA6	3	0
3	N	93	DMF	4	0
3	T	113	DMF	5	0
3	C	69	DMF	1	0
3	K	252	DMF	3	0
3	U	250	DMF	8	0
4	Z	300	SA6	3	0
3	H	66	DMF	3	0
3	D	251	DMF	4	0
3	F	250	DMF	1	0
3	Z	54	DMF	3	0
3	R	92	DMF	2	0
3	K	250	DMF	4	0
3	L	97	DMF	4	0
3	G	24	DMF	2	0

Continued on next page...

Continued from previous page...

Mol	Chain	Res	Type	Clashes	Symm-Clashes
3	V	27	DMF	8	0
3	X	16	DMF	3	0
3	Q	250	DMF	6	0
3	G	70	DMF	1	0
3	Y	249	DMF	1	0
3	K	249	DMF	1	0
4	C	300	SA6	3	0
3	N	104	DMF	7	0
3	R	59	DMF	9	0
4	R	300	SA6	3	0
4	L	300	SA6	3	0
3	V	120	DMF	8	0
3	P	33	DMF	3	0
3	V	42	DMF	7	0
3	X	122	DMF	1	0
3	Q	251	DMF	1	0
3	G	62	DMF	1	0
3	2	108	DMF	5	0
3	N	118	DMF	4	0
4	H	300	SA6	5	0
3	H	43	DMF	4	0
3	E	28	DMF	1	0
3	2	52	DMF	2	0
3	G	98	DMF	2	0
3	G	119	DMF	11	0
3	X	40	DMF	1	0
3	T	84	DMF	3	0
3	L	81	DMF	1	0
3	C	103	DMF	8	0
4	2	300	SA6	4	0
3	Q	249	DMF	2	0
3	T	29	DMF	3	0
4	N	300	SA6	3	0
3	R	95	DMF	1	0
3	D	253	DMF	2	0
3	X	41	DMF	1	0
3	2	87	DMF	2	0
3	A	249	DMF	1	0
3	C	63	DMF	1	0
3	V	82	DMF	2	0
3	Z	94	DMF	3	0
4	P	300	SA6	4	0

Continued on next page...

Continued from previous page...

Mol	Chain	Res	Type	Clashes	Symm-Clashes
3	B	249	DMF	2	0
3	E	73	DMF	3	0
4	E	300	SA6	3	0
3	N	22	DMF	4	0
3	G	111	DMF	1	0
3	E	53	DMF	2	0

The following is a two-dimensional graphical depiction of Mogul quality analysis of bond lengths, bond angles, torsion angles, and ring geometry for all instances of the Ligand of Interest. In addition, ligands with molecular weight > 250 and outliers as shown on the validation Tables will also be included. For torsion angles, if less than 5% of the Mogul distribution of torsion angles is within 10 degrees of the torsion angle in question, then that torsion angle is considered an outlier. Any bond that is central to one or more torsion angles identified as an outlier by Mogul will be highlighted in the graph. For rings, the root-mean-square deviation (RMSD) between the ring in question and similar rings identified by Mogul is calculated over all ring torsion angles. If the average RMSD is greater than 60 degrees and the minimal RMSD between the ring in question and any Mogul-identified rings is also greater than 60 degrees, then that ring is considered an outlier. The outliers are highlighted in purple. The color gray indicates Mogul did not find sufficient equivalents in the CSD to analyse the geometry.

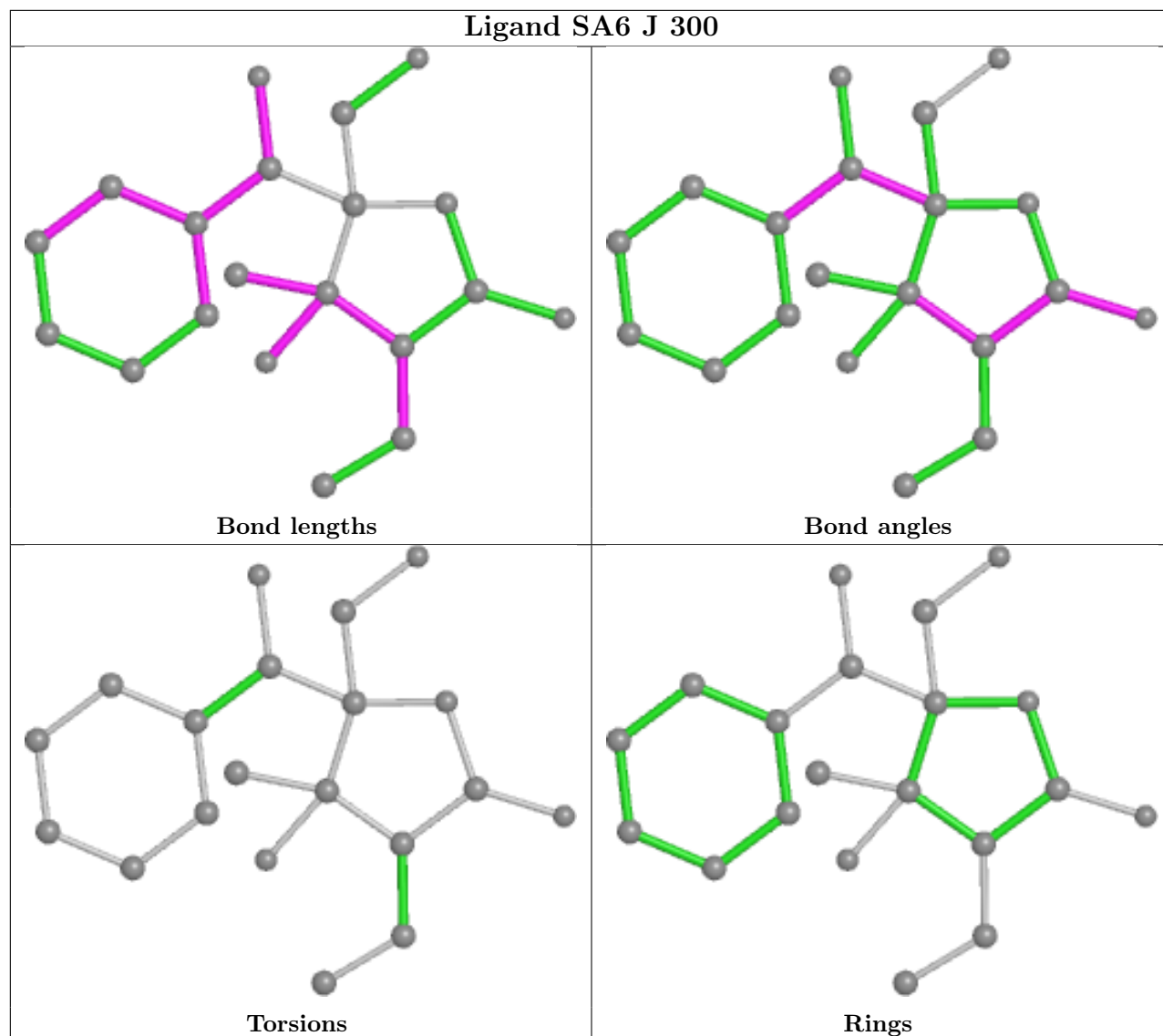

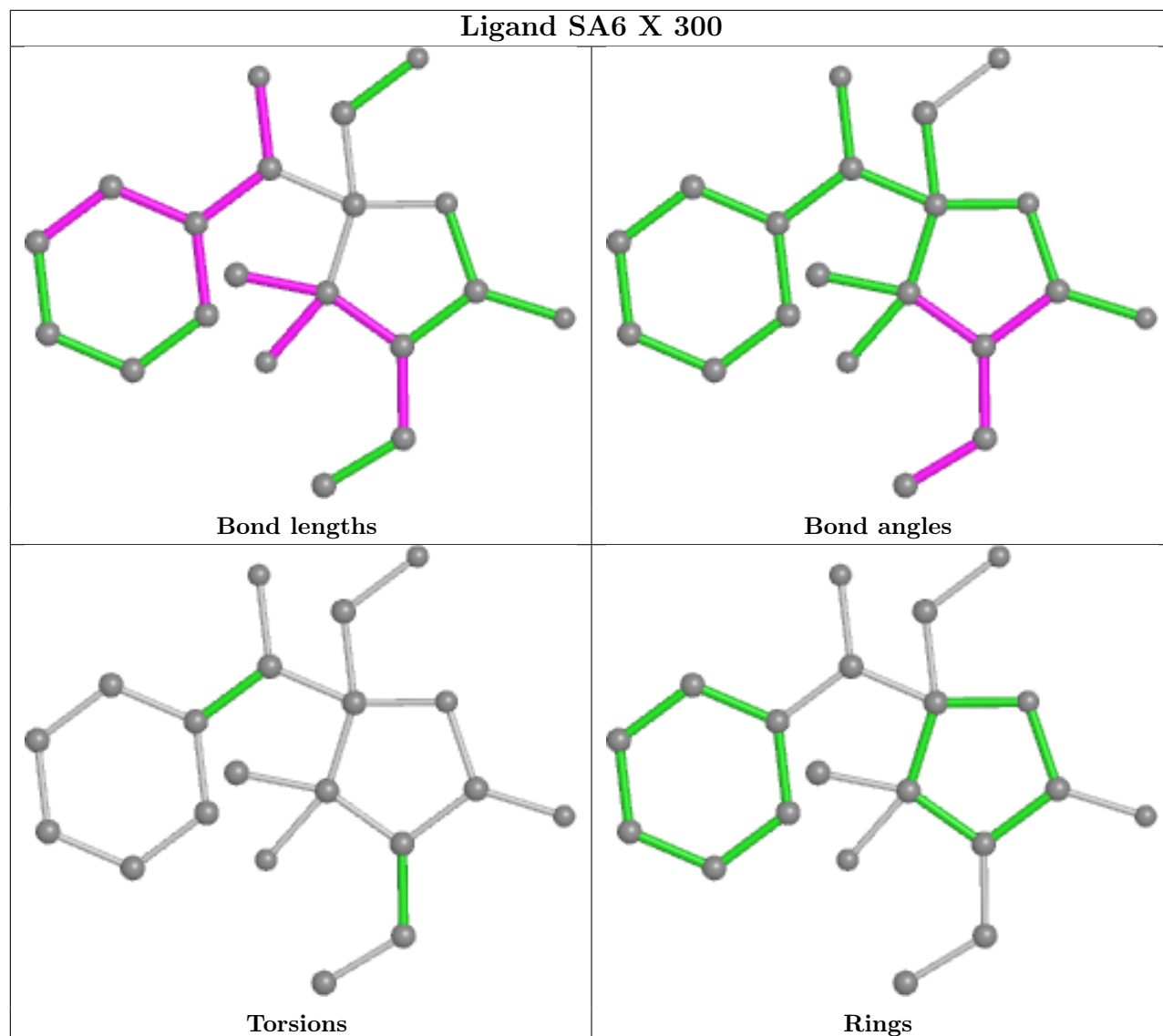

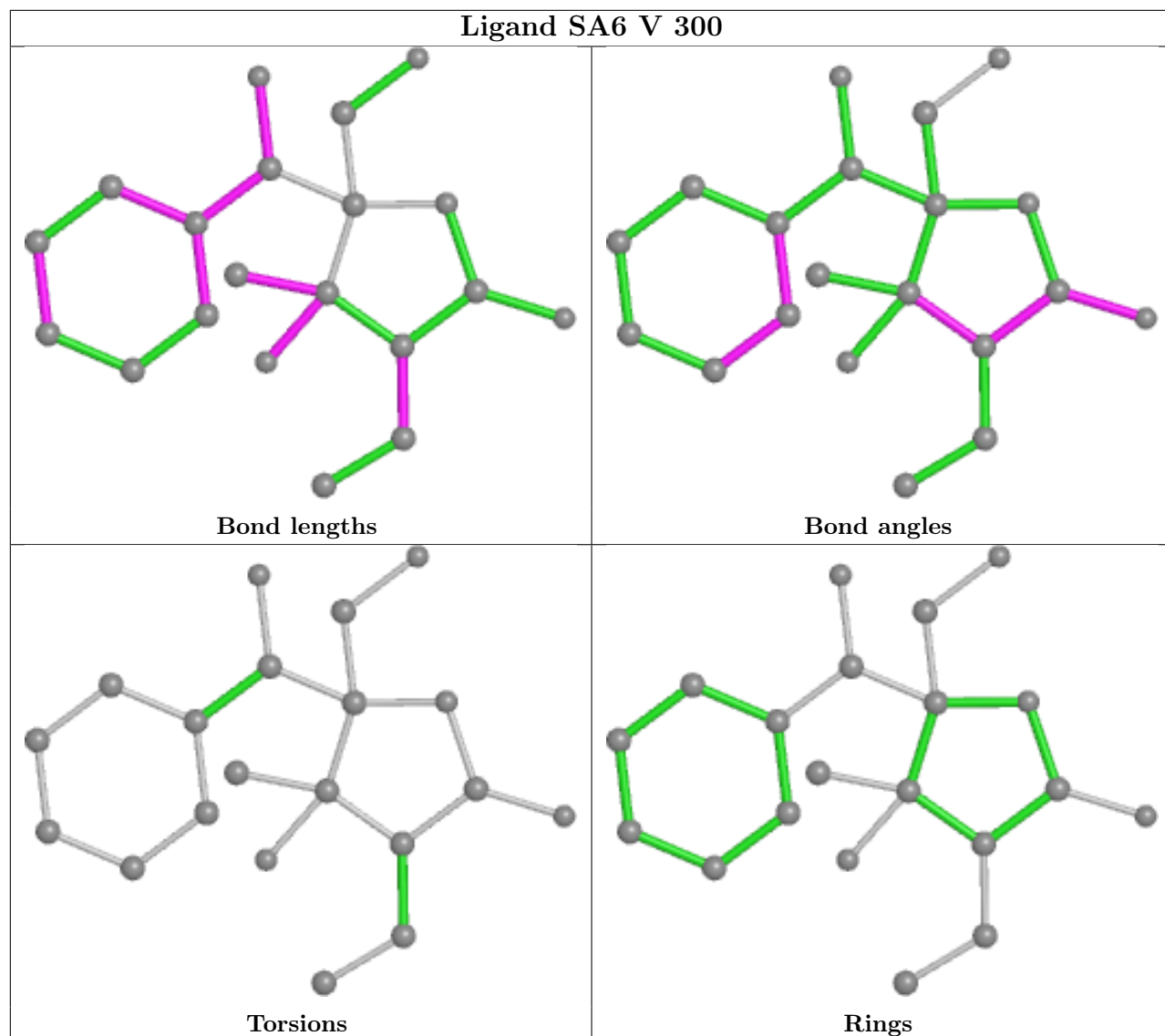

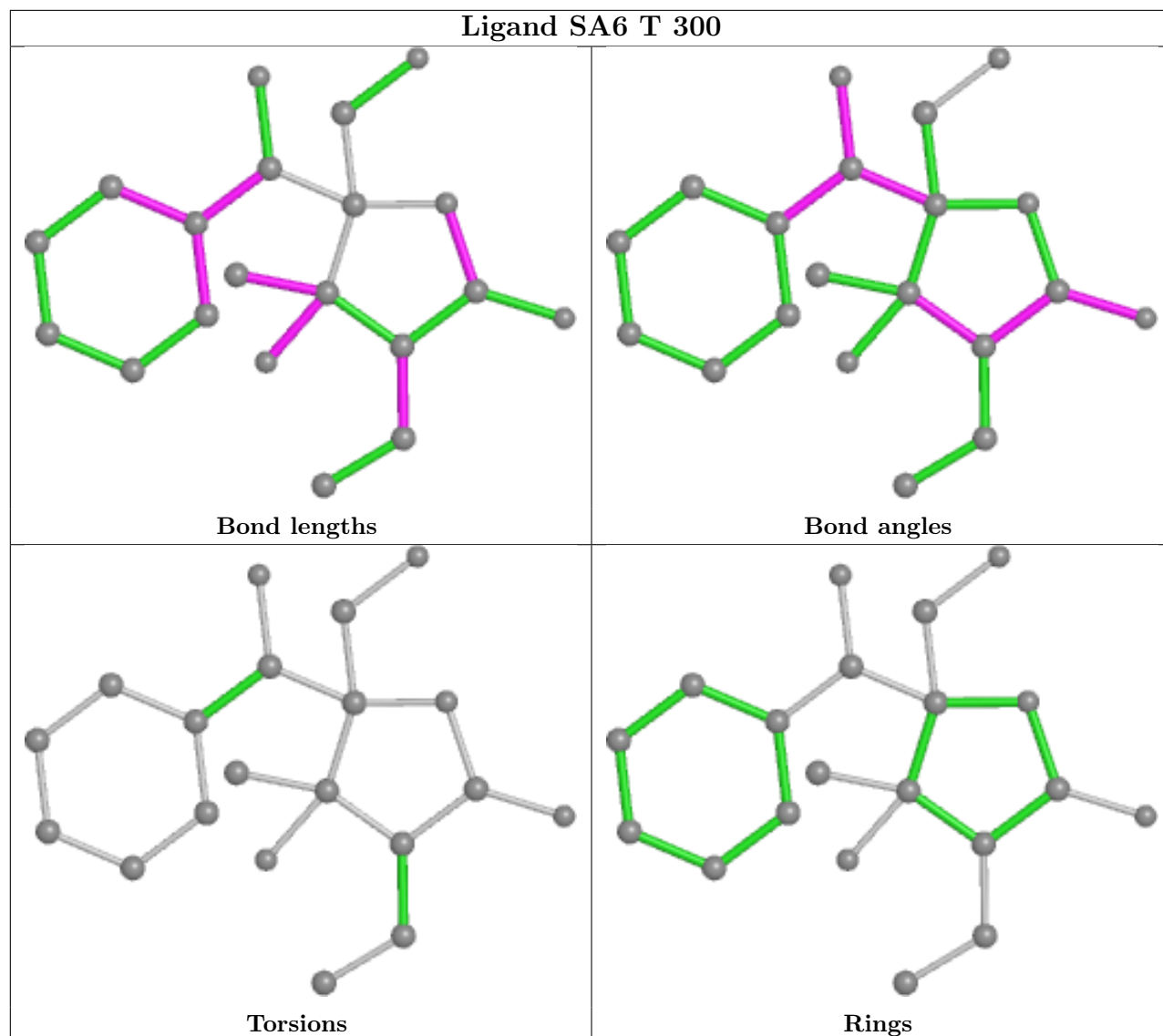

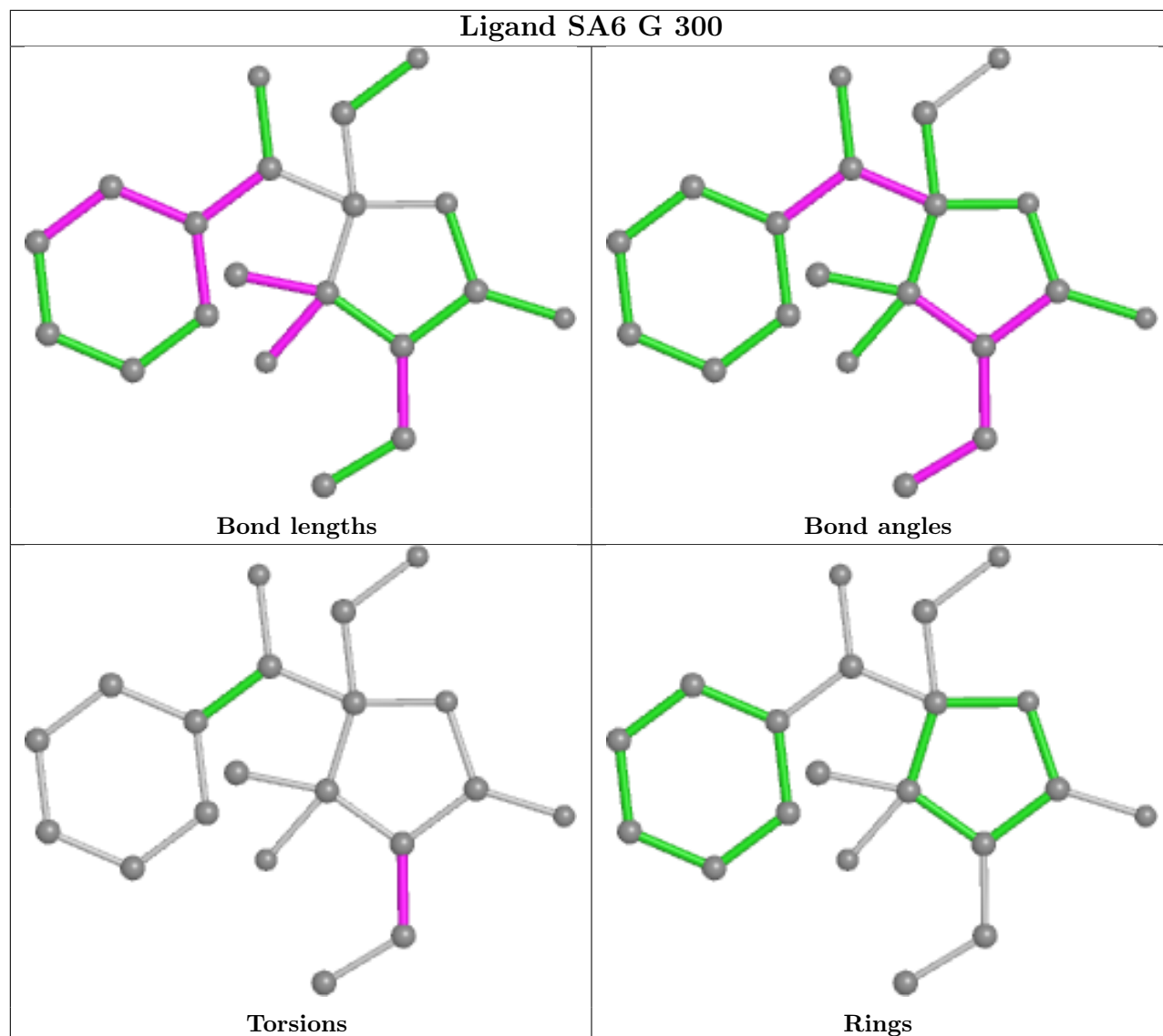

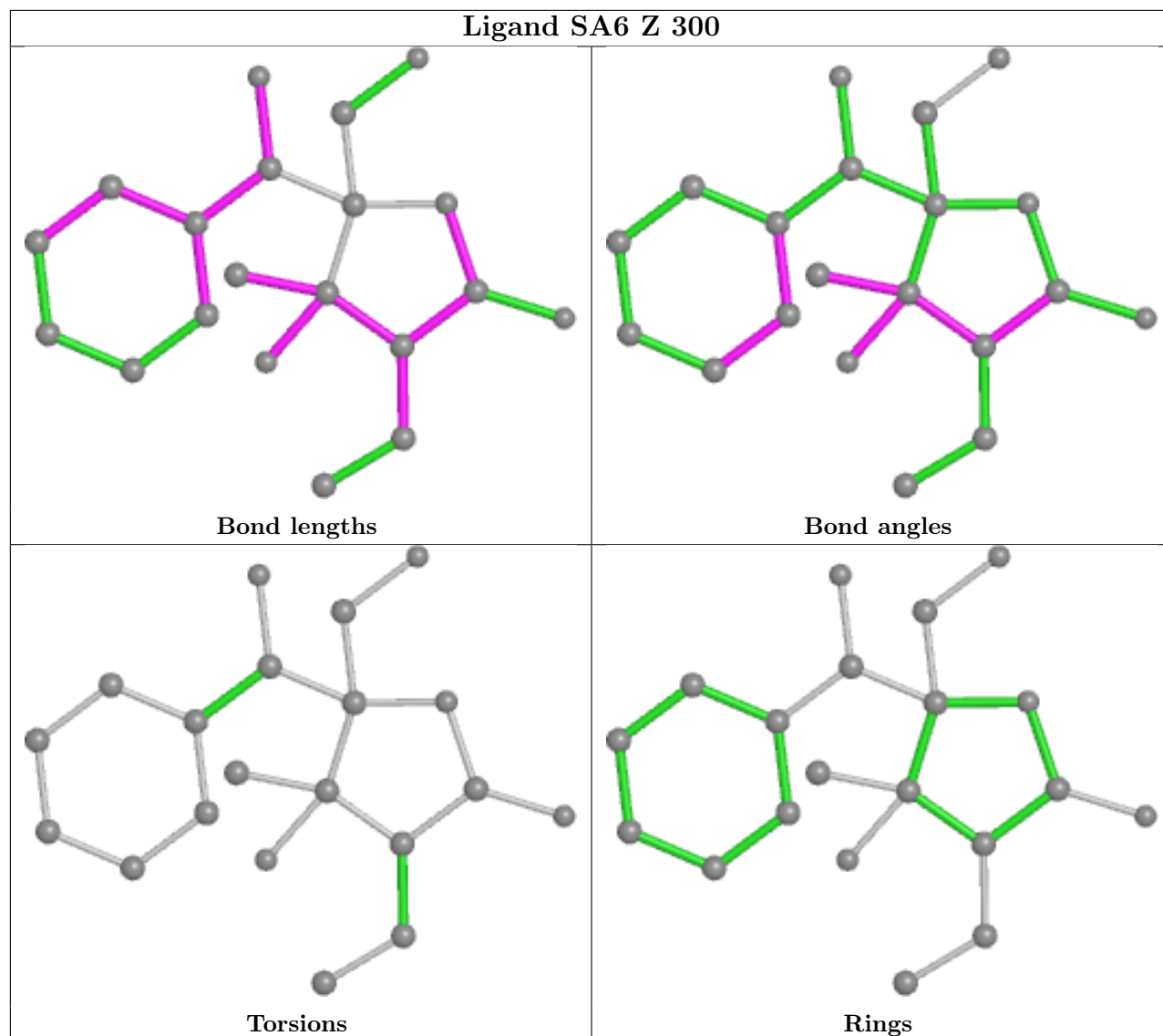

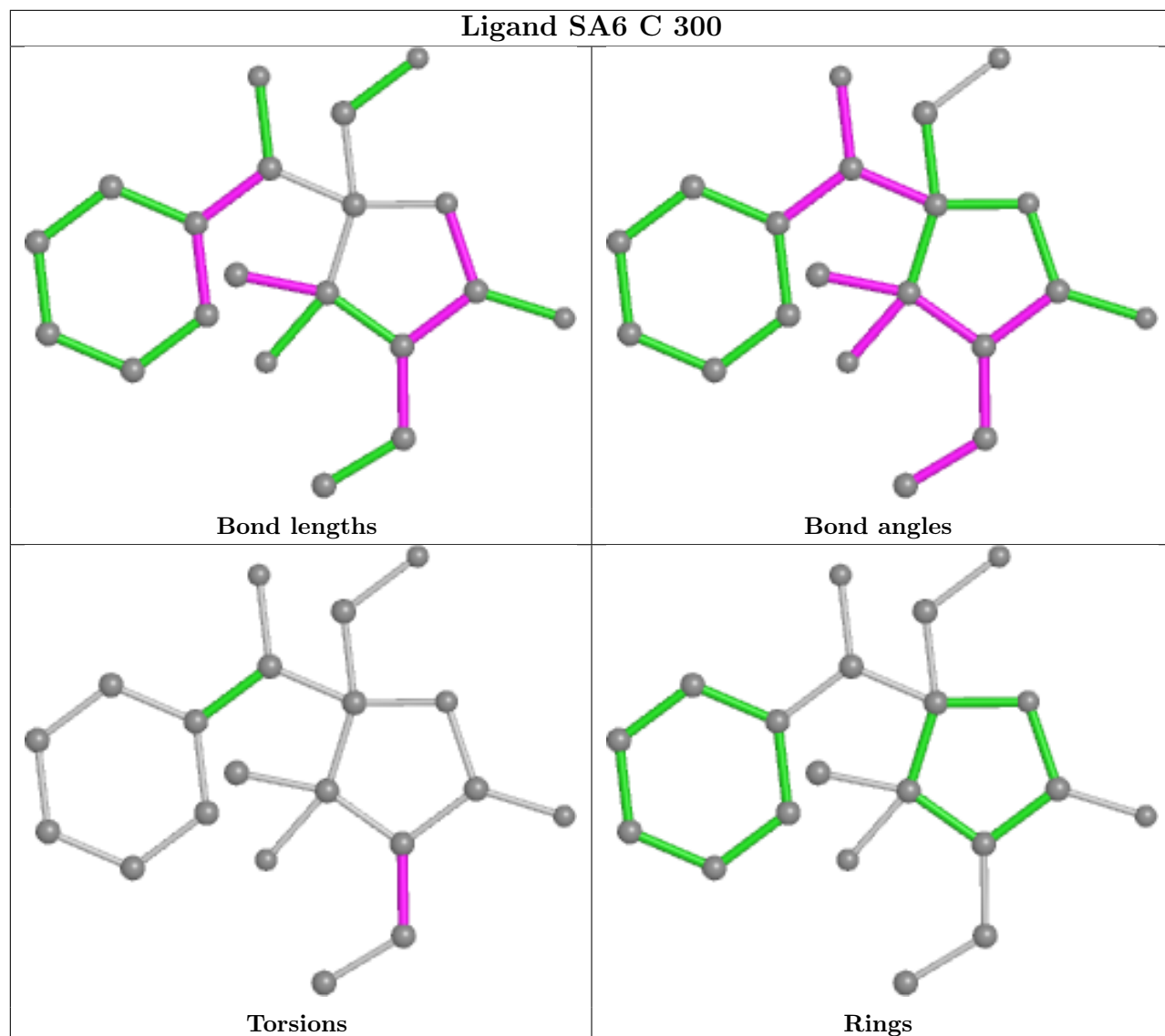

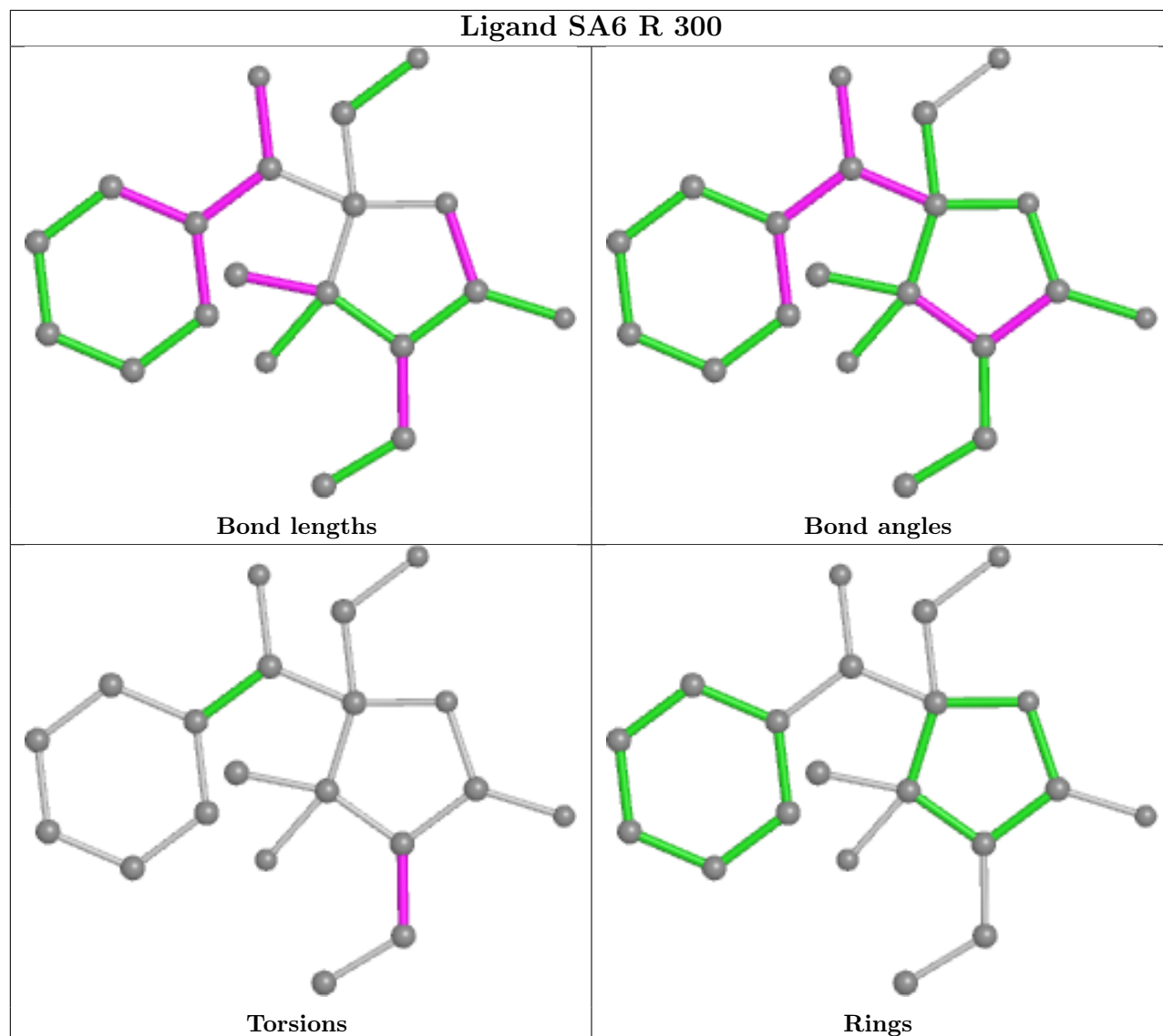

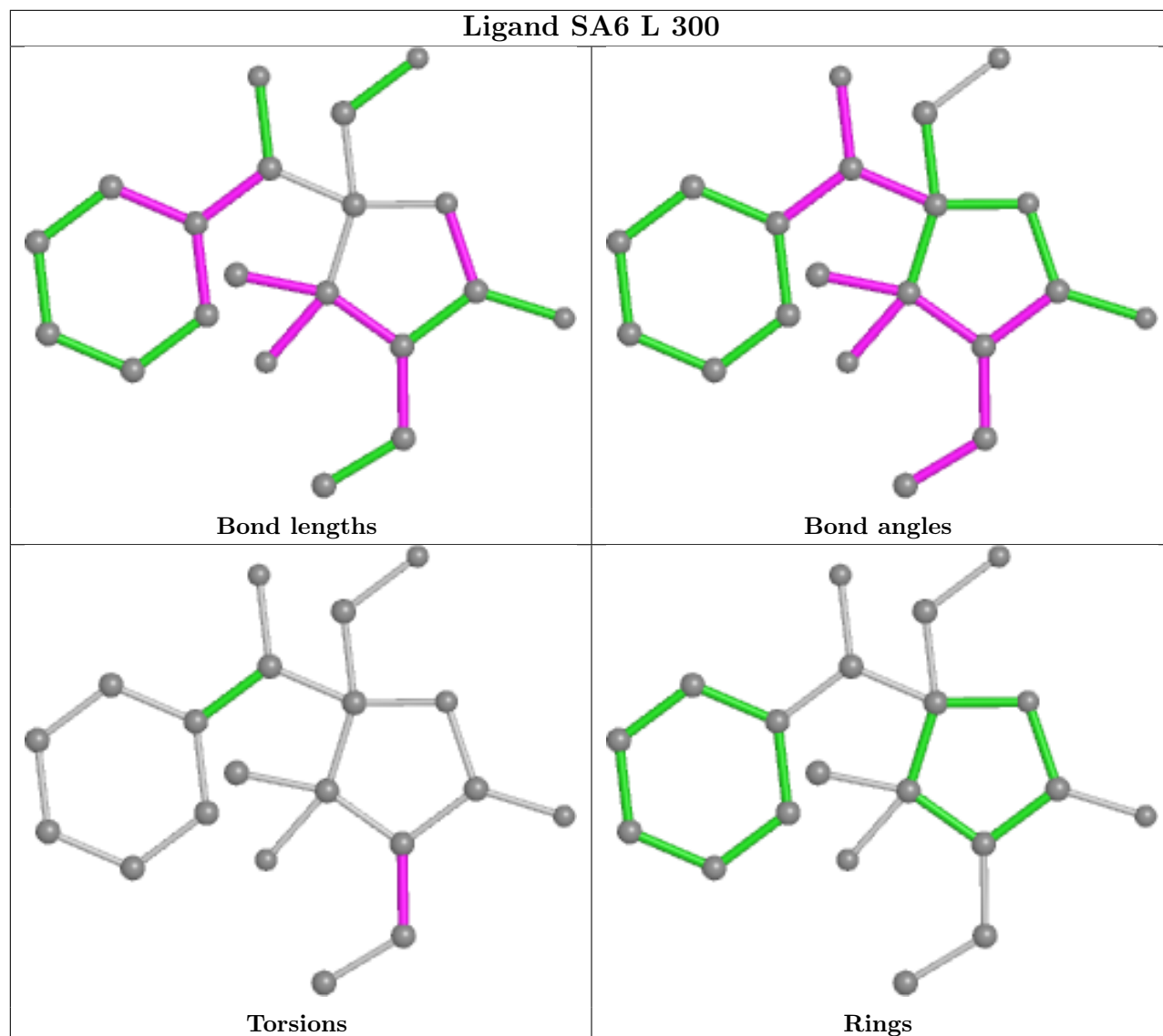

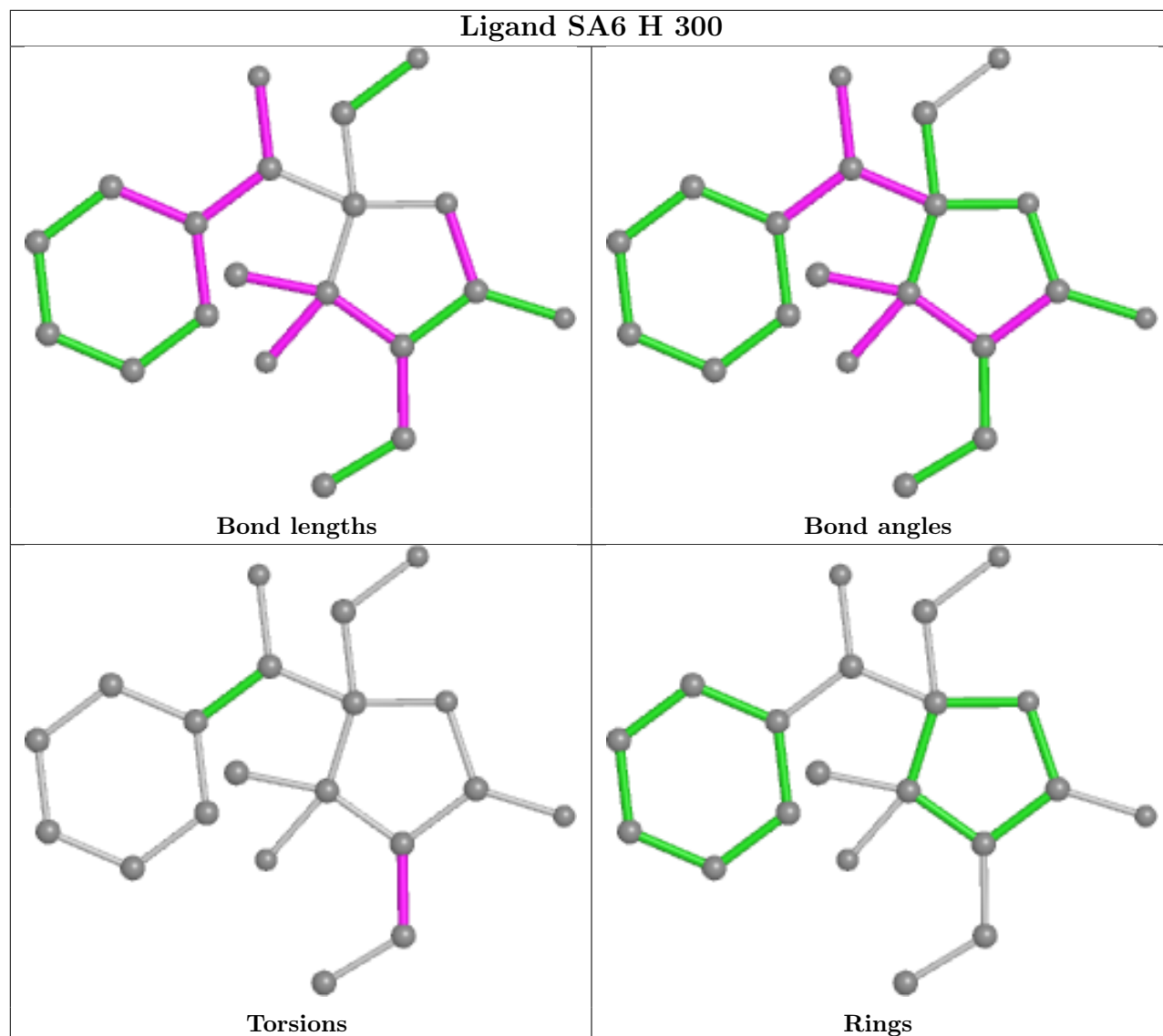

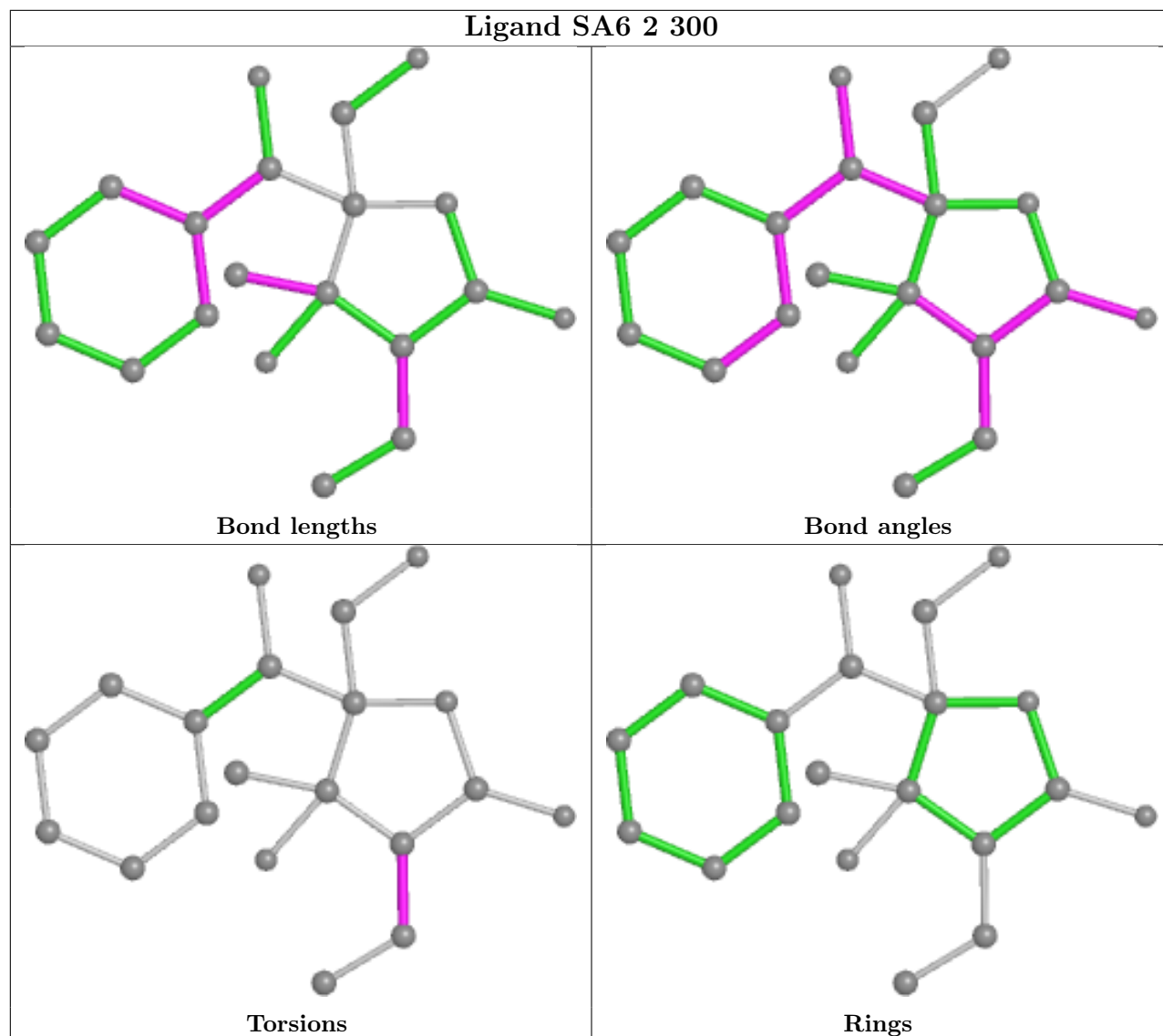

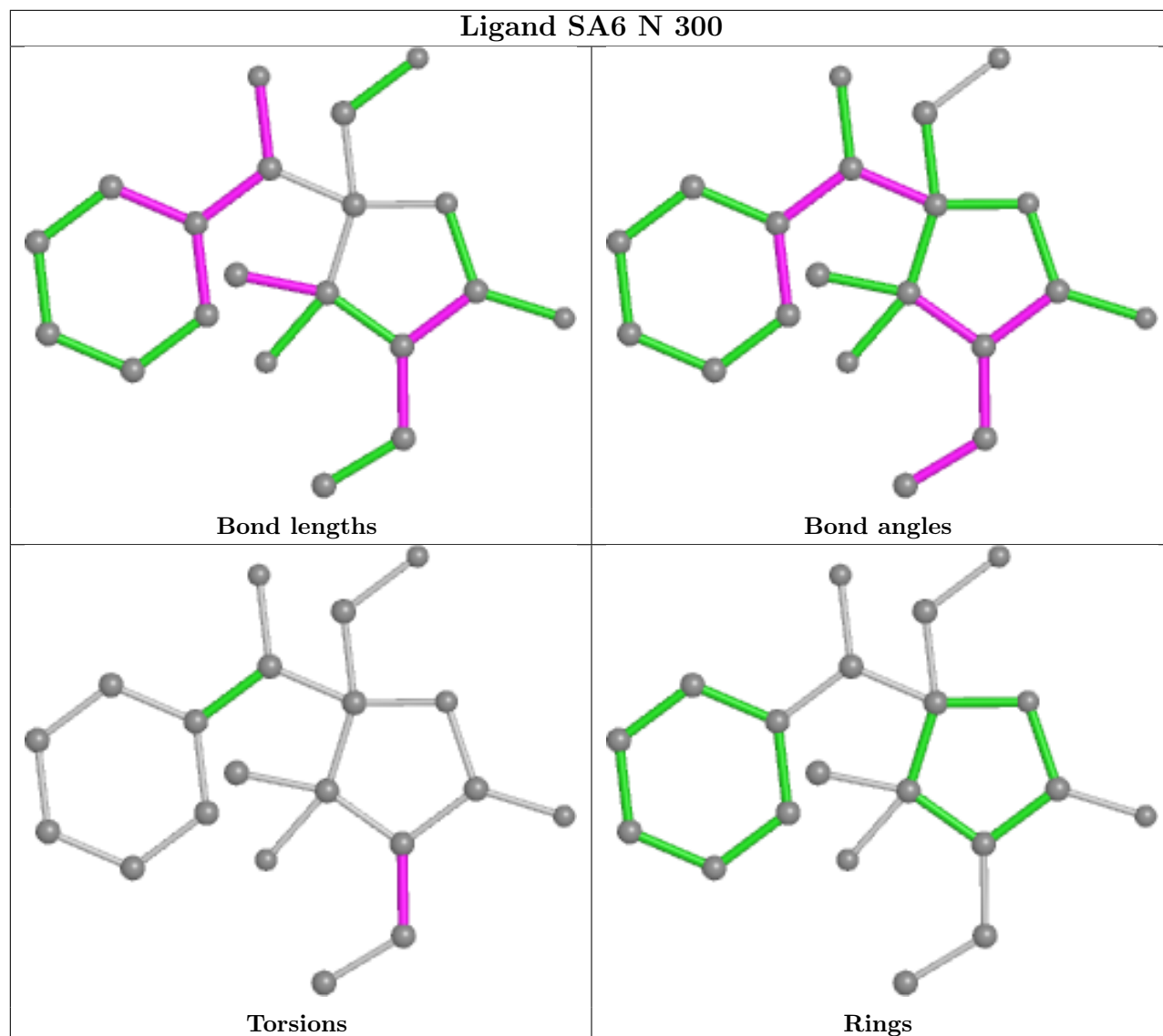

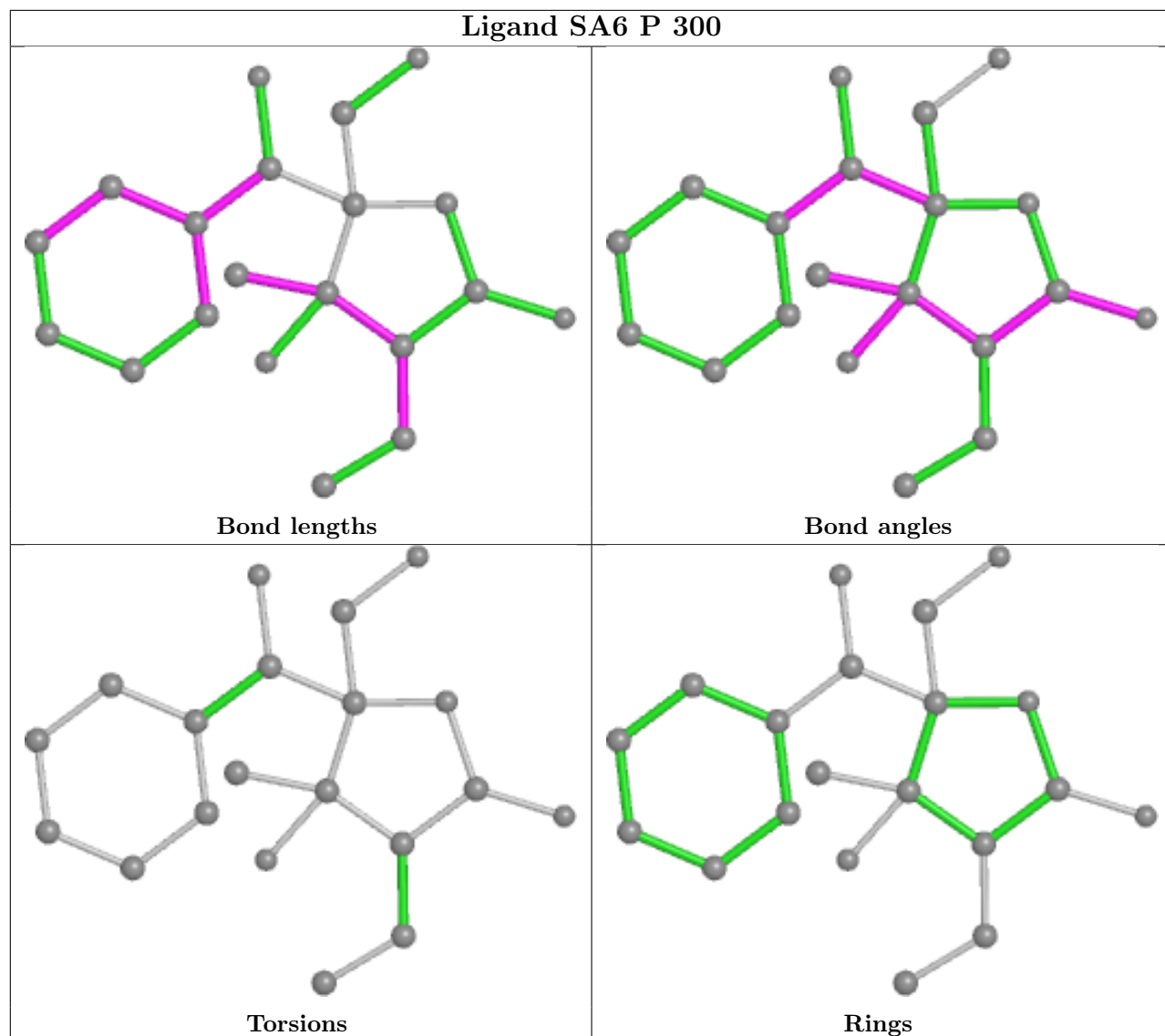

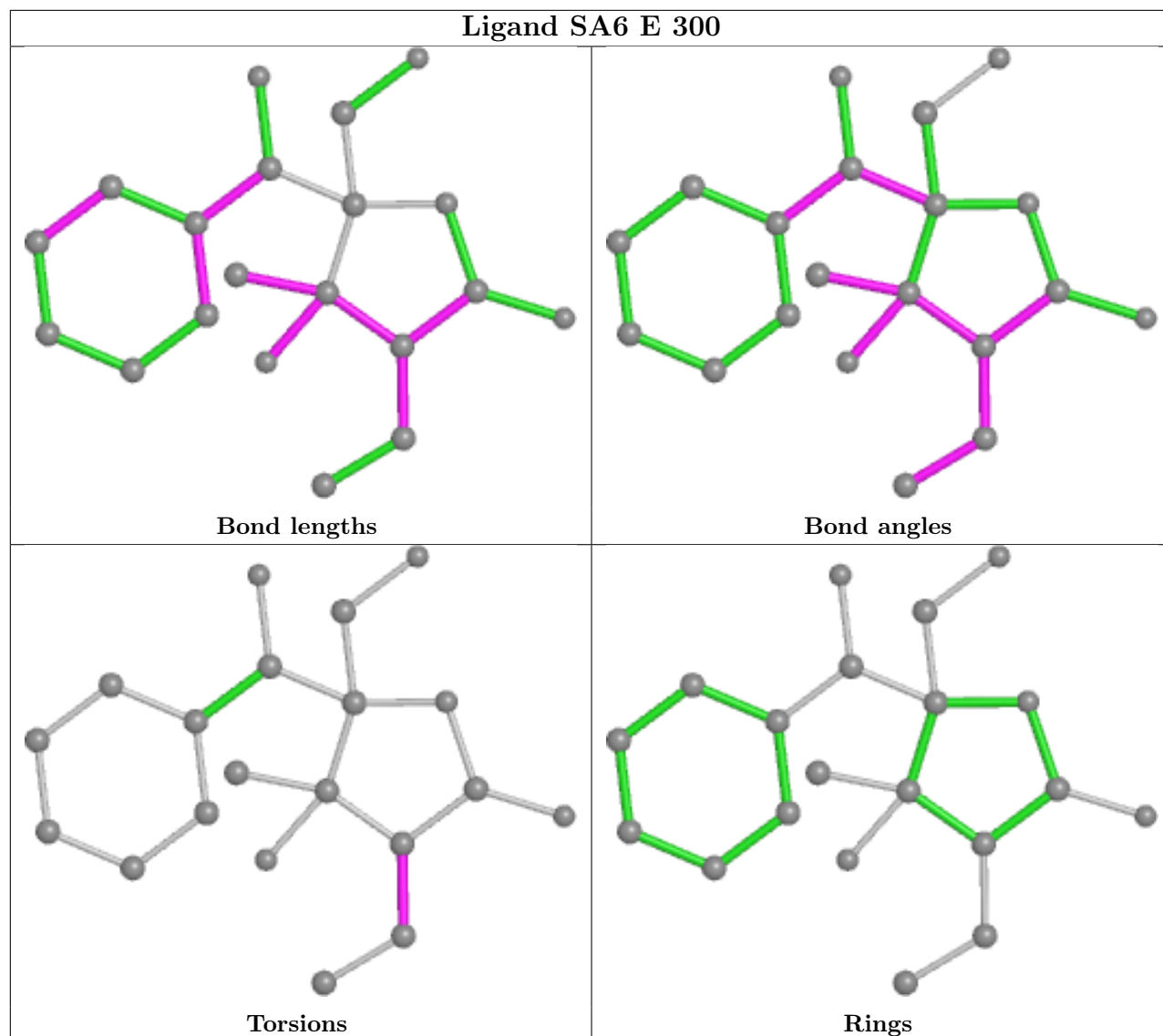

5.7 Other polymers [i](#)

There are no such residues in this entry.

5.8 Polymer linkage issues [i](#)

There are no chain breaks in this entry.

6 Fit of model and data [i](#)

6.1 Protein, DNA and RNA chains [i](#)

In the following table, the column labelled '#RSRZ > 2' contains the number (and percentage) of RSRZ outliers, followed by percent RSRZ outliers for the chain as percentile scores relative to all X-ray entries and entries of similar resolution. The OWAB column contains the minimum, median, 95th percentile and maximum values of the occupancy-weighted average B-factor per residue. The column labelled 'Q < 0.9' lists the number of (and percentage) of residues with an average occupancy less than 0.9.

Mol	Chain	Analysed	<RSRZ>	#RSRZ>2	OWAB(Å ²)	Q<0.9
1	1	215/248 (86%)	0.40	17 (7%) 12 11	19, 48, 88, 109	0
1	A	215/248 (86%)	0.68	31 (14%) 2 2	20, 54, 91, 107	0
1	B	213/248 (85%)	0.46	14 (6%) 18 17	20, 49, 88, 106	0
1	D	214/248 (86%)	1.25	59 (27%) 0 0	20, 65, 98, 110	0
1	F	220/248 (88%)	0.47	17 (7%) 13 12	17, 48, 86, 104	0
1	I	216/248 (87%)	0.57	27 (12%) 3 3	18, 52, 92, 108	0
1	K	216/248 (87%)	0.53	19 (8%) 10 8	21, 55, 92, 107	0
1	M	216/248 (87%)	0.70	31 (14%) 2 2	18, 53, 92, 104	0
1	O	216/248 (87%)	0.56	24 (11%) 5 4	17, 49, 87, 102	0
1	Q	215/248 (86%)	0.49	21 (9%) 7 6	22, 50, 86, 99	0
1	S	216/248 (87%)	0.71	33 (15%) 2 1	20, 56, 91, 104	0
1	U	216/248 (87%)	0.48	25 (11%) 4 4	16, 49, 86, 102	0
1	W	216/248 (87%)	0.97	44 (20%) 1 1	20, 63, 94, 107	0
1	Y	216/248 (87%)	0.80	31 (14%) 2 2	22, 58, 94, 123	0
2	2	223/240 (92%)	-0.47	1 (0%) 92 91	11, 21, 45, 65	0
2	C	222/240 (92%)	-0.51	2 (0%) 84 83	8, 20, 48, 79	0
2	E	223/240 (92%)	-0.49	2 (0%) 84 83	8, 20, 46, 63	0
2	G	222/240 (92%)	-0.47	1 (0%) 91 90	10, 23, 53, 75	0
2	H	222/240 (92%)	-0.50	0 100 100	9, 23, 50, 71	0
2	J	222/240 (92%)	-0.48	1 (0%) 91 90	9, 21, 49, 70	0
2	L	223/240 (92%)	-0.45	1 (0%) 92 91	8, 21, 46, 66	0
2	N	222/240 (92%)	-0.48	1 (0%) 91 90	8, 21, 47, 79	0
2	P	222/240 (92%)	-0.50	0 100 100	10, 23, 49, 73	0
2	R	239/240 (99%)	-0.50	4 (1%) 70 68	8, 20, 55, 83	0

Continued on next page...

Continued from previous page...

Mol	Chain	Analysed	<RSRZ>	#RSRZ>2	OWAB(Å ²)	Q<0.9
2	T	223/240 (92%)	-0.39	1 (0%) 92 91	10, 24, 53, 72	0
2	V	239/240 (99%)	-0.48	3 (1%) 77 75	8, 20, 63, 91	0
2	X	223/240 (92%)	-0.46	2 (0%) 84 83	10, 24, 56, 73	0
2	Z	223/240 (92%)	-0.43	3 (1%) 77 75	11, 24, 52, 69	0
All	All	6168/6832 (90%)	0.08	415 (6%) 17 16	8, 33, 84, 123	0

The worst 5 of 415 RSRZ outliers are listed below:

Mol	Chain	Res	Type	RSRZ
1	I	6	PHE	8.4
1	M	203	LEU	7.4
1	S	7	ILE	7.0
1	I	203	LEU	6.9
1	Y	8	SER	6.7

6.2 Non-standard residues in protein, DNA, RNA chains [i](#)

There are no non-standard protein/DNA/RNA residues in this entry.

6.3 Carbohydrates [i](#)

There are no monosaccharides in this entry.

6.4 Ligands [i](#)

In the following table, the Atoms column lists the number of modelled atoms in the group and the number defined in the chemical component dictionary. The B-factors column lists the minimum, median, 95th percentile and maximum values of B factors of atoms in the group. The column labelled 'Q< 0.9' lists the number of atoms with occupancy less than 0.9.

Mol	Type	Chain	Res	Atoms	RSCC	RSR	B-factors(Å ²)	Q<0.9
3	DMF	D	253	5/5	0.52	0.45	20,20,20,20	0
3	DMF	J	45	5/5	0.52	0.43	41,43,45,46	0
3	DMF	M	251	5/5	0.54	0.35	64,64,66,66	0
3	DMF	E	28	5/5	0.58	0.33	61,61,63,64	0
3	DMF	L	81	5/5	0.61	0.51	59,60,61,62	0
3	DMF	F	249	5/5	0.64	0.42	90,91,91,91	0
3	DMF	E	73	5/5	0.64	0.52	120,120,121,121	0

Continued on next page...

Continued from previous page...

Mol	Type	Chain	Res	Atoms	RSCC	RSR	B-factors(Å ²)	Q<0.9
3	DMF	X	122	5/5	0.65	0.32	20,20,20,20	0
3	DMF	T	84	5/5	0.68	0.45	59,59,60,62	0
3	DMF	K	251	5/5	0.71	0.37	63,63,64,64	0
3	DMF	2	57	5/5	0.71	0.34	54,56,57,57	0
3	DMF	O	251	5/5	0.72	0.35	20,20,20,20	0
3	DMF	X	40	5/5	0.73	0.29	84,85,85,85	0
3	DMF	V	39	5/5	0.74	0.29	60,60,61,61	0
3	DMF	N	104	5/5	0.74	0.48	20,20,20,20	0
3	DMF	Z	54	5/5	0.75	0.24	58,59,60,61	0
3	DMF	2	52	5/5	0.75	0.27	77,77,78,78	0
3	DMF	G	62	5/5	0.75	0.28	72,73,73,74	0
3	DMF	H	117	5/5	0.76	0.41	20,20,20,20	0
3	DMF	2	49	5/5	0.76	0.33	57,57,57,58	0
3	DMF	R	59	5/5	0.76	0.44	54,55,57,57	0
3	DMF	B	250	5/5	0.76	0.30	53,53,55,55	0
3	DMF	E	53	5/5	0.77	0.25	56,57,58,59	0
3	DMF	R	95	5/5	0.77	0.43	20,20,20,20	0
3	DMF	V	82	5/5	0.77	0.36	45,47,47,48	0
3	DMF	K	252	5/5	0.78	0.36	80,81,82,82	0
3	DMF	M	250	5/5	0.78	0.27	60,61,61,62	0
3	DMF	T	102	5/5	0.79	0.43	20,20,20,20	0
3	DMF	T	10	5/5	0.79	0.33	71,72,72,74	0
3	DMF	G	64	5/5	0.79	0.40	66,68,68,69	0
3	DMF	2	112	5/5	0.79	0.48	20,20,20,20	0
3	DMF	H	66	5/5	0.80	0.32	69,69,69,70	0
3	DMF	Z	114	5/5	0.80	0.44	20,20,20,20	0
3	DMF	C	63	5/5	0.80	0.23	58,59,59,60	0
3	DMF	G	24	5/5	0.80	0.40	65,67,68,68	0
3	DMF	K	249	5/5	0.80	0.21	49,50,51,52	0
3	DMF	Z	18	5/5	0.80	0.28	55,55,55,55	0
3	DMF	G	70	5/5	0.81	0.28	37,38,41,41	0
3	DMF	X	41	5/5	0.81	0.27	61,61,62,62	0
3	DMF	C	103	5/5	0.81	0.43	20,20,20,20	0
3	DMF	S	250	5/5	0.81	0.19	59,59,60,61	0
3	DMF	P	51	5/5	0.81	0.23	75,76,76,77	0
3	DMF	C	47	5/5	0.82	0.26	61,62,62,62	0
3	DMF	F	251	5/5	0.82	0.26	54,54,55,55	0
3	DMF	P	60	5/5	0.82	0.24	68,69,69,69	0
3	DMF	L	50	5/5	0.83	0.20	55,56,57,57	0
3	DMF	V	120	5/5	0.83	0.40	20,20,20,20	0
3	DMF	W	249	5/5	0.83	0.25	69,70,71,72	0
3	DMF	X	16	5/5	0.83	0.22	86,86,86,86	0

Continued on next page...

Continued from previous page...

Mol	Type	Chain	Res	Atoms	RSCC	RSR	B-factors(\AA^2)	Q<0.9
3	DMF	P	2	5/5	0.83	0.31	62,62,64,64	0
3	DMF	U	249	5/5	0.83	0.24	40,40,44,45	0
3	DMF	2	108	5/5	0.83	0.45	20,20,20,20	0
3	DMF	P	33	5/5	0.83	0.20	65,66,66,66	0
3	DMF	M	249	5/5	0.84	0.18	46,47,48,48	0
3	DMF	J	110	5/5	0.84	0.44	20,20,20,20	0
3	DMF	L	36	5/5	0.84	0.21	41,42,43,43	0
3	DMF	A	249	5/5	0.84	0.27	44,44,44,44	0
3	DMF	P	86	5/5	0.84	0.50	20,20,20,20	0
3	DMF	Q	250	5/5	0.84	0.28	84,85,85,86	0
3	DMF	E	20	5/5	0.84	0.44	76,77,77,78	0
3	DMF	Y	251	5/5	0.84	0.53	20,20,20,20	0
3	DMF	K	250	5/5	0.85	0.33	77,78,79,79	0
3	DMF	X	15	5/5	0.85	0.23	66,67,68,70	0
3	DMF	A	250	5/5	0.85	0.27	39,41,42,44	0
3	DMF	V	109	5/5	0.85	0.42	20,20,20,20	0
3	DMF	R	89	5/5	0.85	0.39	20,20,20,20	0
3	DMF	D	251	5/5	0.86	0.27	94,95,96,96	0
3	DMF	H	72	5/5	0.86	0.44	20,20,20,20	0
3	DMF	H	91	5/5	0.86	0.31	20,20,20,20	0
3	DMF	P	14	5/5	0.86	0.28	56,58,58,59	0
3	DMF	D	252	5/5	0.86	0.33	20,20,20,20	0
3	DMF	F	250	5/5	0.86	0.24	56,56,58,59	0
3	DMF	D	249	5/5	0.86	0.24	53,53,53,54	0
3	DMF	G	111	5/5	0.86	0.40	20,20,20,20	0
3	DMF	G	119	5/5	0.86	0.44	20,20,20,20	0
3	DMF	G	77	5/5	0.87	0.24	49,50,50,51	0
3	DMF	E	100	5/5	0.87	0.46	20,20,20,20	0
3	DMF	Z	94	5/5	0.87	0.45	20,20,20,20	0
3	DMF	T	113	5/5	0.87	0.48	20,20,20,20	0
3	DMF	N	22	5/5	0.87	0.29	44,45,49,50	0
3	DMF	V	27	5/5	0.87	0.32	63,63,64,64	0
3	DMF	D	250	5/5	0.87	0.21	61,63,64,65	0
3	DMF	2	101	5/5	0.87	0.38	20,20,20,20	0
3	DMF	O	250	5/5	0.87	0.21	44,45,46,48	0
3	DMF	J	123	5/5	0.87	0.53	20,20,20,20	0
3	DMF	G	12	5/5	0.88	0.34	60,61,62,63	0
3	DMF	R	80	5/5	0.88	0.19	74,75,76,76	0
3	DMF	C	121	5/5	0.88	0.24	20,20,20,20	0
3	DMF	B	249	5/5	0.88	0.22	50,51,51,53	0
3	DMF	2	4	5/5	0.88	0.22	62,62,62,62	0
3	DMF	U	250	5/5	0.88	0.21	49,50,51,51	0

Continued on next page...

Continued from previous page...

Mol	Type	Chain	Res	Atoms	RSCC	RSR	B-factors(\AA^2)	Q<0.9
3	DMF	G	98	5/5	0.88	0.45	20,20,20,20	0
3	DMF	N	93	5/5	0.88	0.32	20,20,20,20	0
3	DMF	T	29	5/5	0.88	0.22	76,76,76,76	0
3	DMF	Y	250	5/5	0.88	0.20	42,42,44,44	0
3	DMF	V	83	5/5	0.88	0.22	58,59,60,62	0
3	DMF	C	88	5/5	0.89	0.43	20,20,20,20	0
3	DMF	P	107	5/5	0.89	0.34	20,20,20,20	0
3	DMF	O	249	5/5	0.89	0.19	39,40,41,41	0
3	DMF	M	252	5/5	0.89	0.29	20,20,20,20	0
3	DMF	V	42	5/5	0.90	0.27	58,58,59,61	0
3	DMF	Q	251	5/5	0.90	0.19	53,53,56,57	0
3	DMF	E	75	5/5	0.90	0.23	64,64,64,65	0
3	DMF	H	43	5/5	0.90	0.27	82,82,83,83	0
3	DMF	S	249	5/5	0.91	0.25	54,54,55,56	0
3	DMF	L	97	5/5	0.91	0.28	20,20,20,20	0
3	DMF	1	249	5/5	0.91	0.14	45,47,48,49	0
3	DMF	W	250	5/5	0.91	0.22	63,63,64,64	0
3	DMF	H	71	5/5	0.91	0.28	54,55,55,56	0
3	DMF	N	118	5/5	0.92	0.38	20,20,20,20	0
3	DMF	V	116	5/5	0.92	0.21	20,20,20,20	0
3	DMF	C	38	5/5	0.92	0.24	64,64,65,65	0
3	DMF	V	32	5/5	0.92	0.18	73,74,74,74	0
3	DMF	C	69	5/5	0.92	0.25	48,48,50,50	0
3	DMF	Q	249	5/5	0.92	0.21	48,48,49,49	0
3	DMF	I	250	5/5	0.92	0.22	41,41,42,42	0
3	DMF	P	56	5/5	0.92	0.19	59,60,60,61	0
4	SA6	H	300	20/20	0.92	0.11	16,21,23,24	0
3	DMF	Y	249	5/5	0.93	0.22	62,64,64,65	0
3	DMF	I	249	5/5	0.93	0.18	40,42,42,43	0
3	DMF	N	90	5/5	0.93	0.32	20,20,20,20	0
3	DMF	T	115	5/5	0.93	0.39	20,20,20,20	0
4	SA6	L	300	20/20	0.93	0.10	16,19,26,27	0
3	DMF	R	92	5/5	0.94	0.33	20,20,20,20	0
4	SA6	G	300	20/20	0.94	0.09	11,19,22,24	0
4	SA6	N	300	20/20	0.94	0.10	13,18,23,26	0
4	SA6	T	300	20/20	0.94	0.10	17,22,28,29	0
4	SA6	V	300	20/20	0.94	0.10	15,17,21,22	0
4	SA6	Z	300	20/20	0.94	0.10	17,19,22,25	0
4	SA6	E	300	20/20	0.95	0.09	12,18,21,24	0
4	SA6	J	300	20/20	0.95	0.08	12,19,24,27	0
4	SA6	R	300	20/20	0.95	0.10	12,21,24,31	0
4	SA6	2	300	20/20	0.95	0.11	17,20,28,29	0

Continued on next page...

Continued from previous page...

Mol	Type	Chain	Res	Atoms	RSCC	RSR	B-factors(\AA^2)	Q<0.9
4	SA6	P	300	20/20	0.96	0.09	16,20,28,29	0
4	SA6	X	300	20/20	0.96	0.09	15,17,23,25	0
3	DMF	2	87	5/5	0.96	0.37	20,20,20,20	0
4	SA6	C	300	20/20	0.96	0.09	16,19,24,24	0

The following is a graphical depiction of the model fit to experimental electron density of all instances of the Ligand of Interest. In addition, ligands with molecular weight > 250 and outliers as shown on the geometry validation Tables will also be included. Each fit is shown from different orientation to approximate a three-dimensional view.

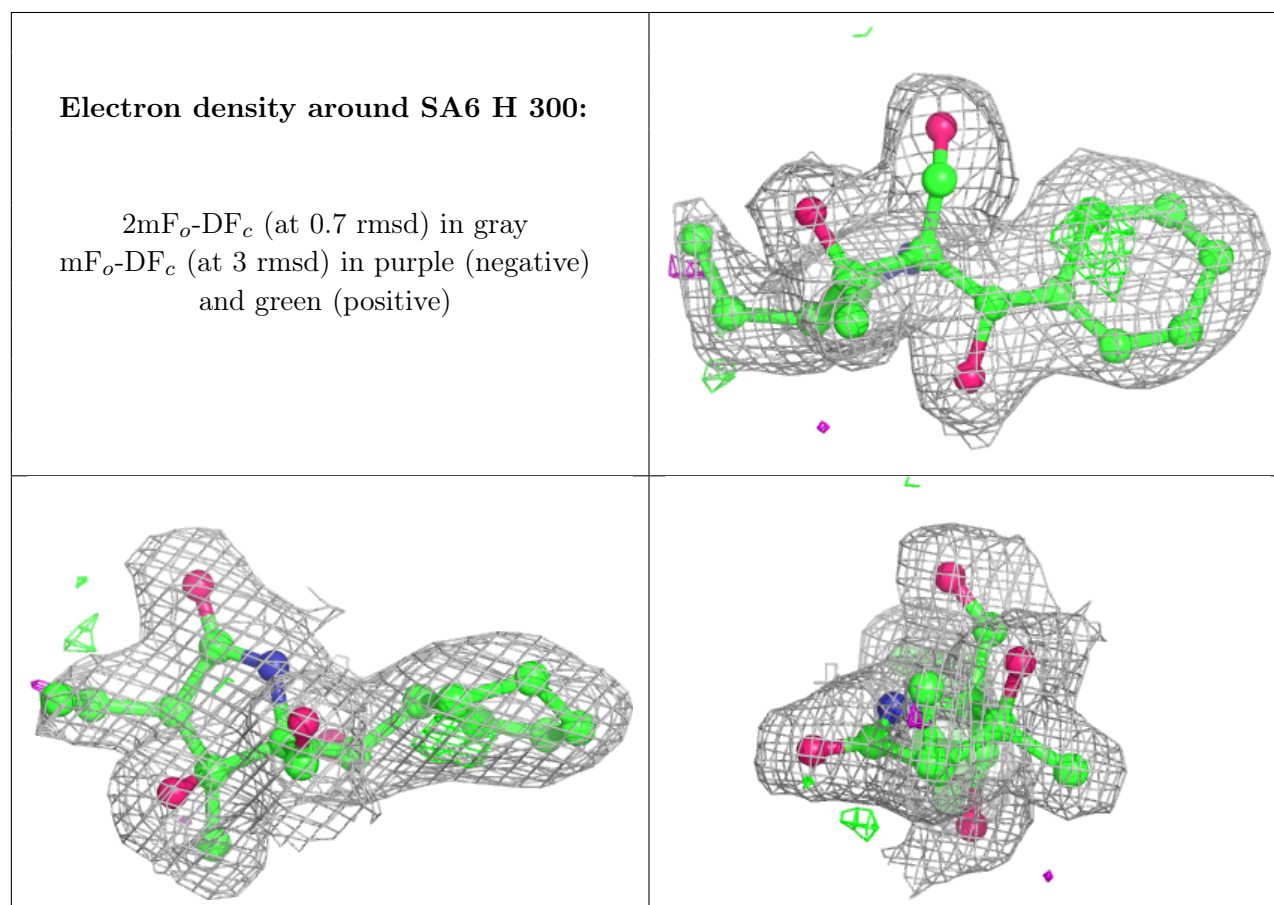

Electron density around SA6 L 300:

$2mF_o-DF_c$ (at 0.7 rmsd) in gray
 mF_o-DF_c (at 3 rmsd) in purple (negative)
and green (positive)

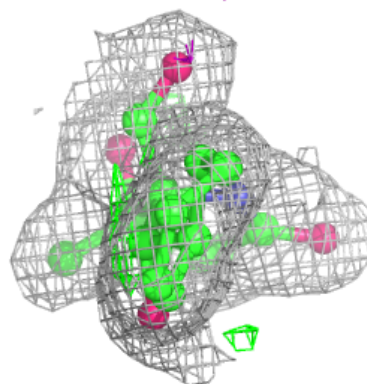
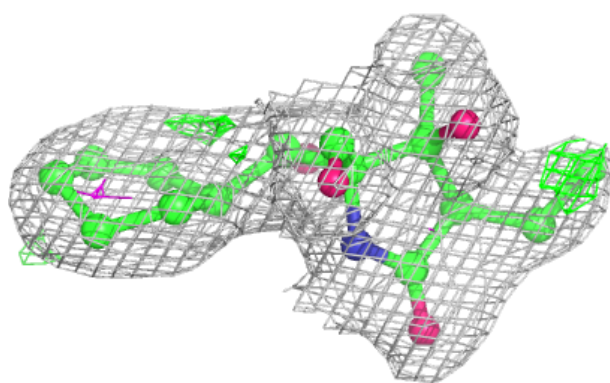
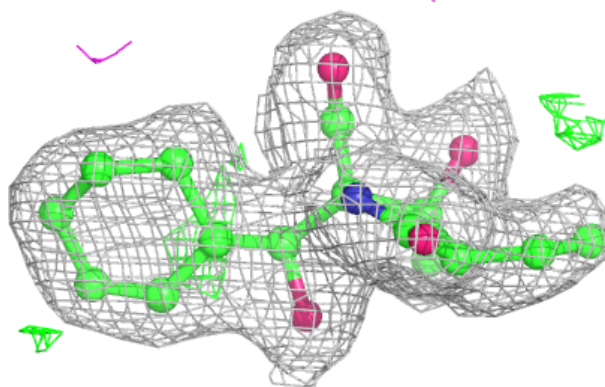
**Electron density around SA6 G 300:**

$2mF_o-DF_c$ (at 0.7 rmsd) in gray
 mF_o-DF_c (at 3 rmsd) in purple (negative)
and green (positive)

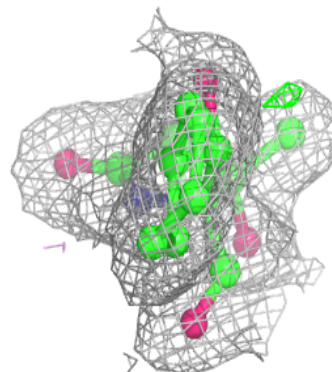
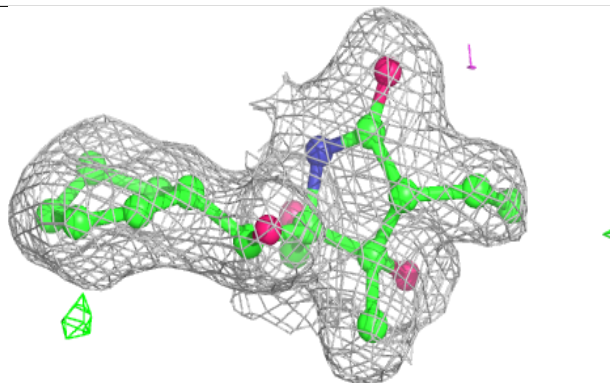
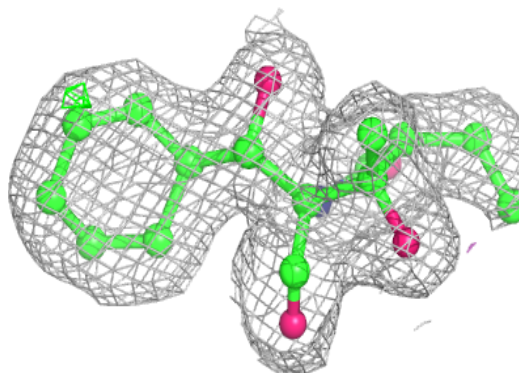

Electron density around SA6 N 300:

$2mF_o-DF_c$ (at 0.7 rmsd) in gray
 mF_o-DF_c (at 3 rmsd) in purple (negative)
and green (positive)

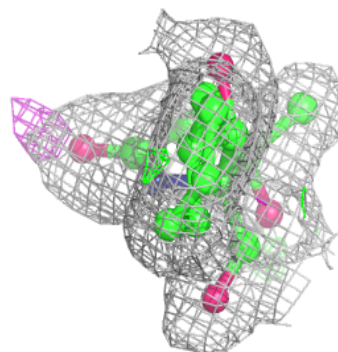
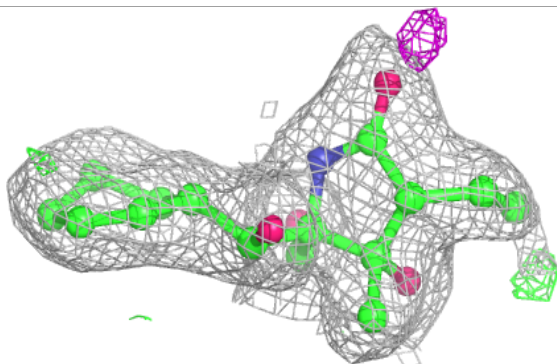
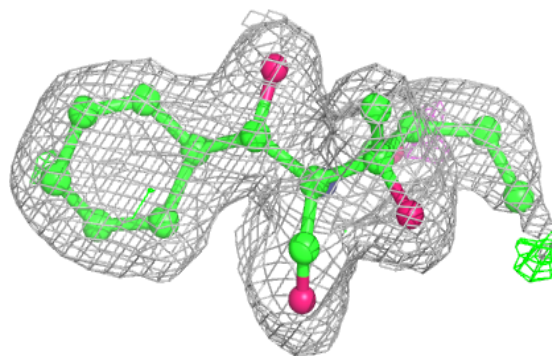
**Electron density around SA6 T 300:**

$2mF_o-DF_c$ (at 0.7 rmsd) in gray
 mF_o-DF_c (at 3 rmsd) in purple (negative)
and green (positive)

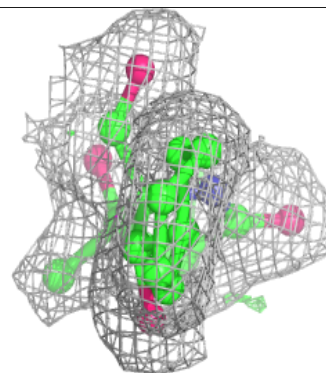
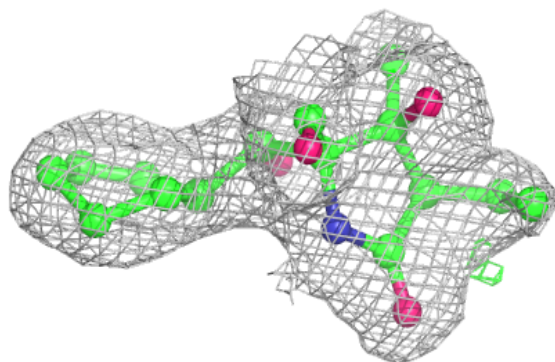
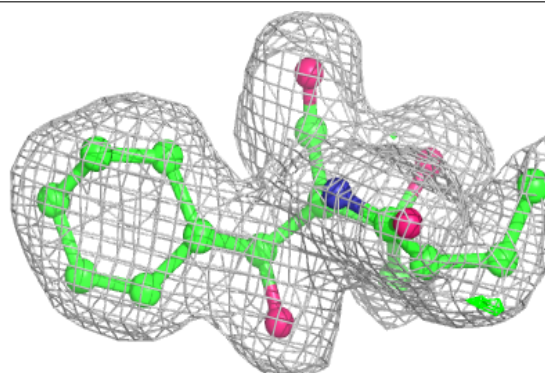

Electron density around SA6 V 300:

$2mF_o-DF_c$ (at 0.7 rmsd) in gray
 mF_o-DF_c (at 3 rmsd) in purple (negative)
and green (positive)

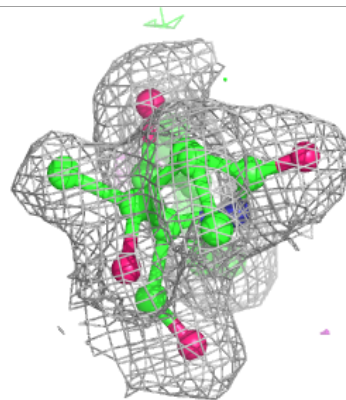
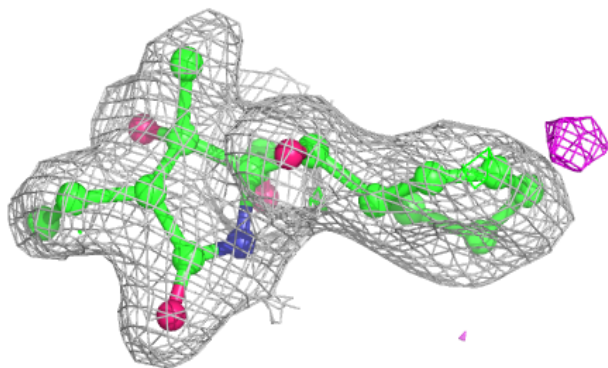
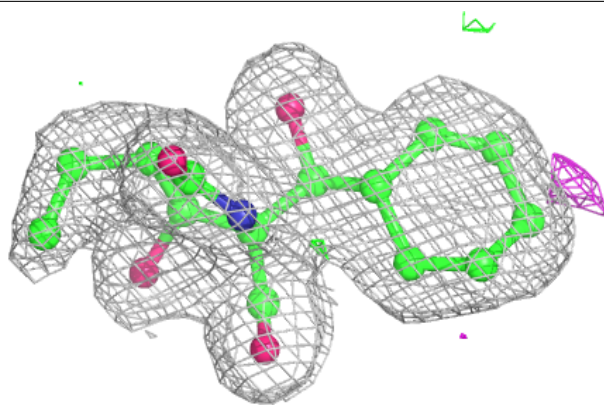
**Electron density around SA6 Z 300:**

$2mF_o-DF_c$ (at 0.7 rmsd) in gray
 mF_o-DF_c (at 3 rmsd) in purple (negative)
and green (positive)

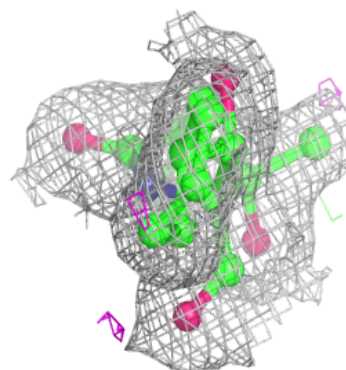
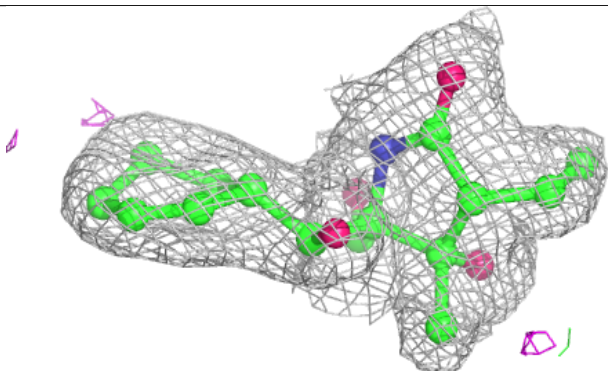
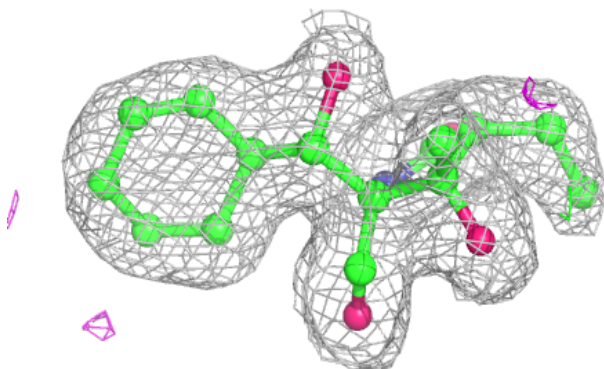

Electron density around SA6 E 300:

$2mF_o-DF_c$ (at 0.7 rmsd) in gray
 mF_o-DF_c (at 3 rmsd) in purple (negative)
and green (positive)

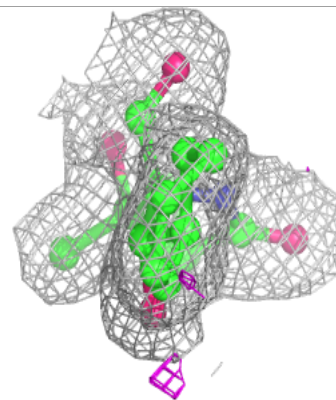
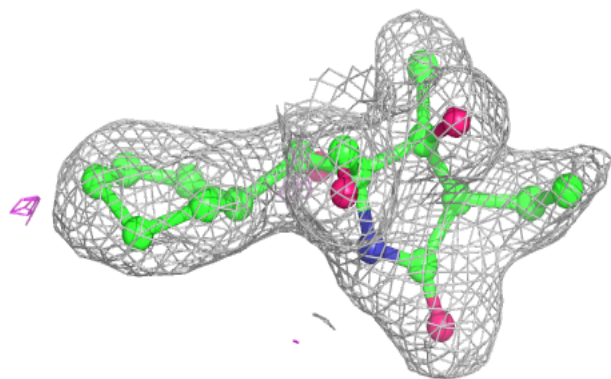
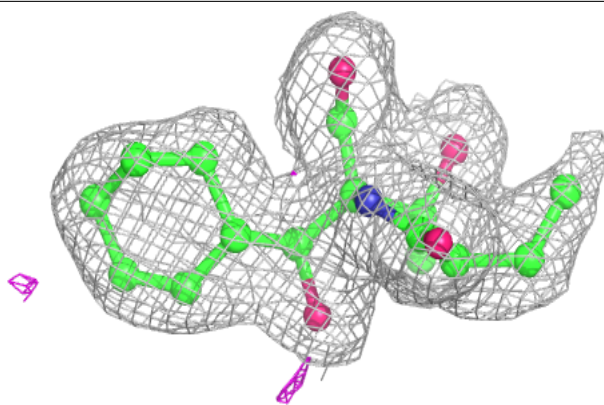
**Electron density around SA6 J 300:**

$2mF_o-DF_c$ (at 0.7 rmsd) in gray
 mF_o-DF_c (at 3 rmsd) in purple (negative)
and green (positive)

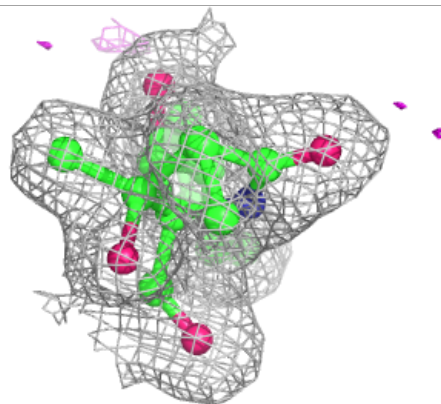
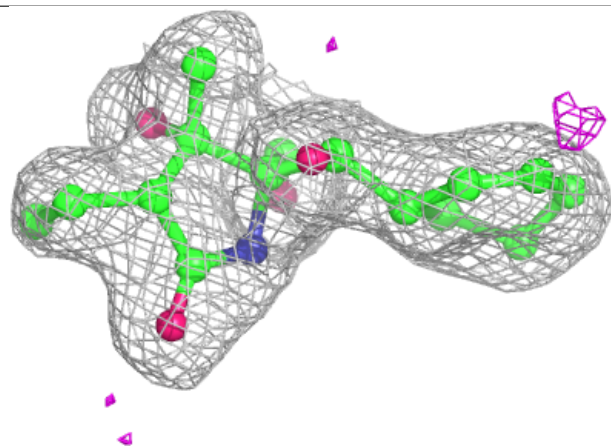
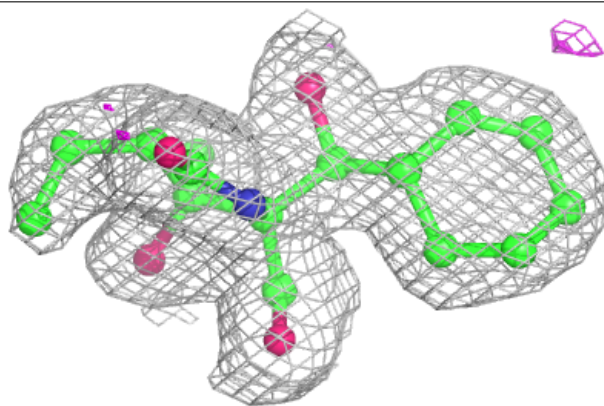

Electron density around SA6 R 300:

$2mF_o-DF_c$ (at 0.7 rmsd) in gray
 mF_o-DF_c (at 3 rmsd) in purple (negative)
and green (positive)

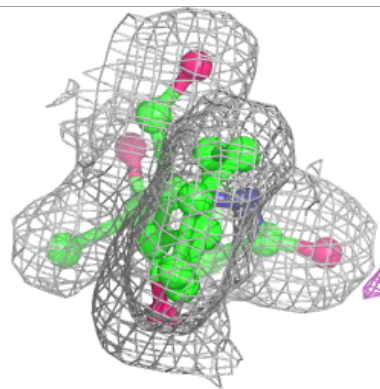
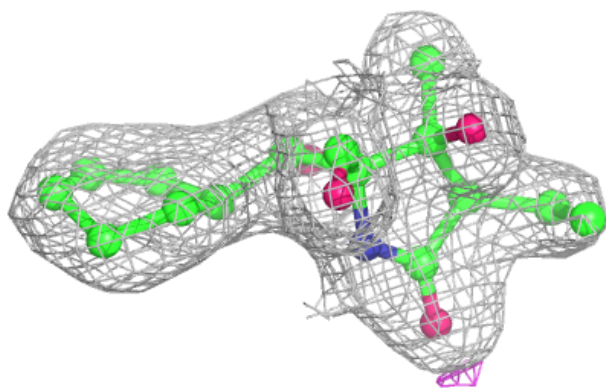
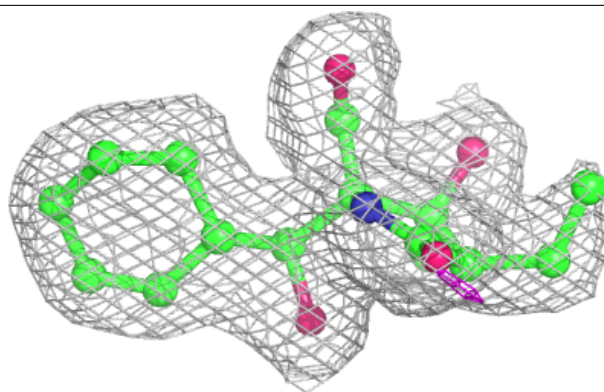
**Electron density around SA6 2 300:**

$2mF_o-DF_c$ (at 0.7 rmsd) in gray
 mF_o-DF_c (at 3 rmsd) in purple (negative)
and green (positive)

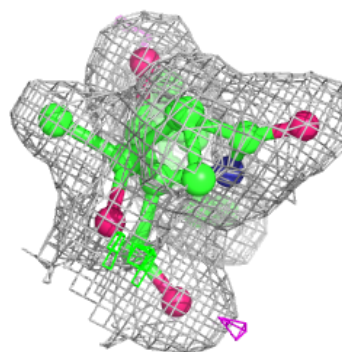
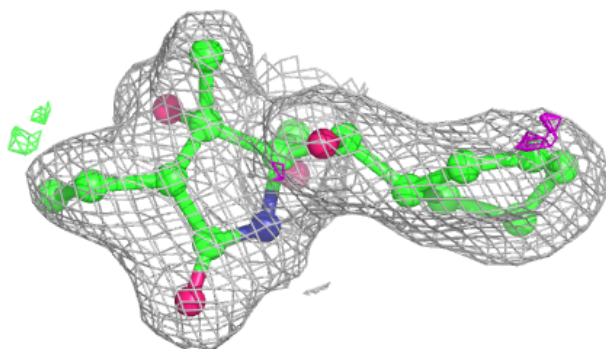
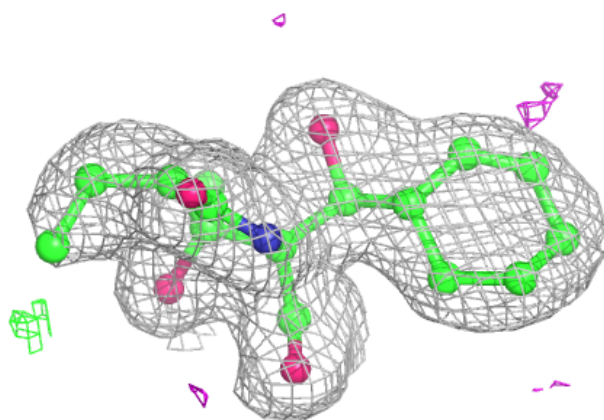

Electron density around SA6 P 300:

$2mF_o-DF_c$ (at 0.7 rmsd) in gray
 mF_o-DF_c (at 3 rmsd) in purple (negative)
and green (positive)

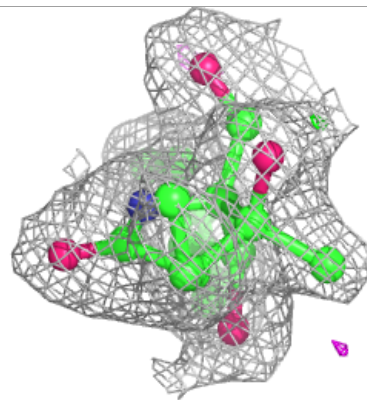
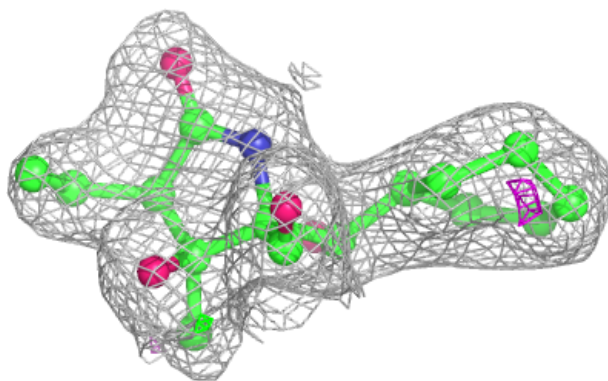
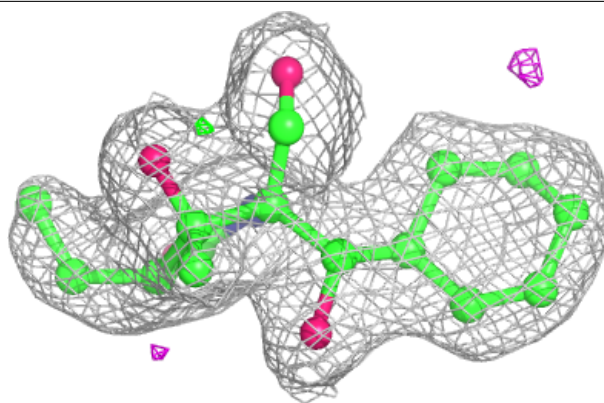
**Electron density around SA6 X 300:**

$2mF_o-DF_c$ (at 0.7 rmsd) in gray
 mF_o-DF_c (at 3 rmsd) in purple (negative)
and green (positive)

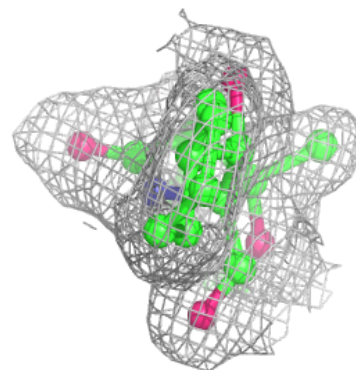
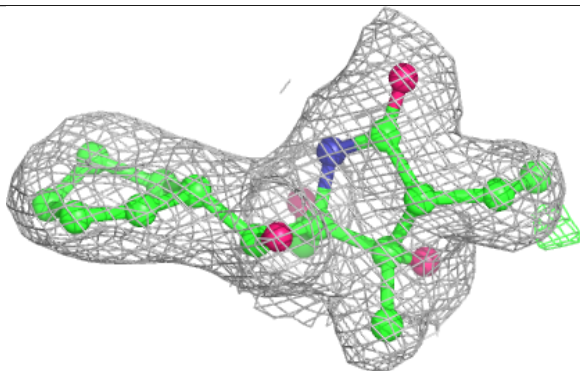
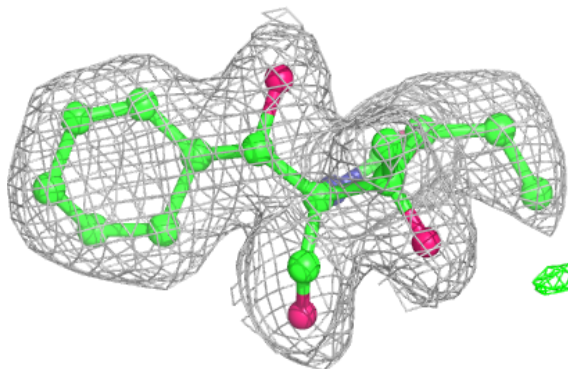

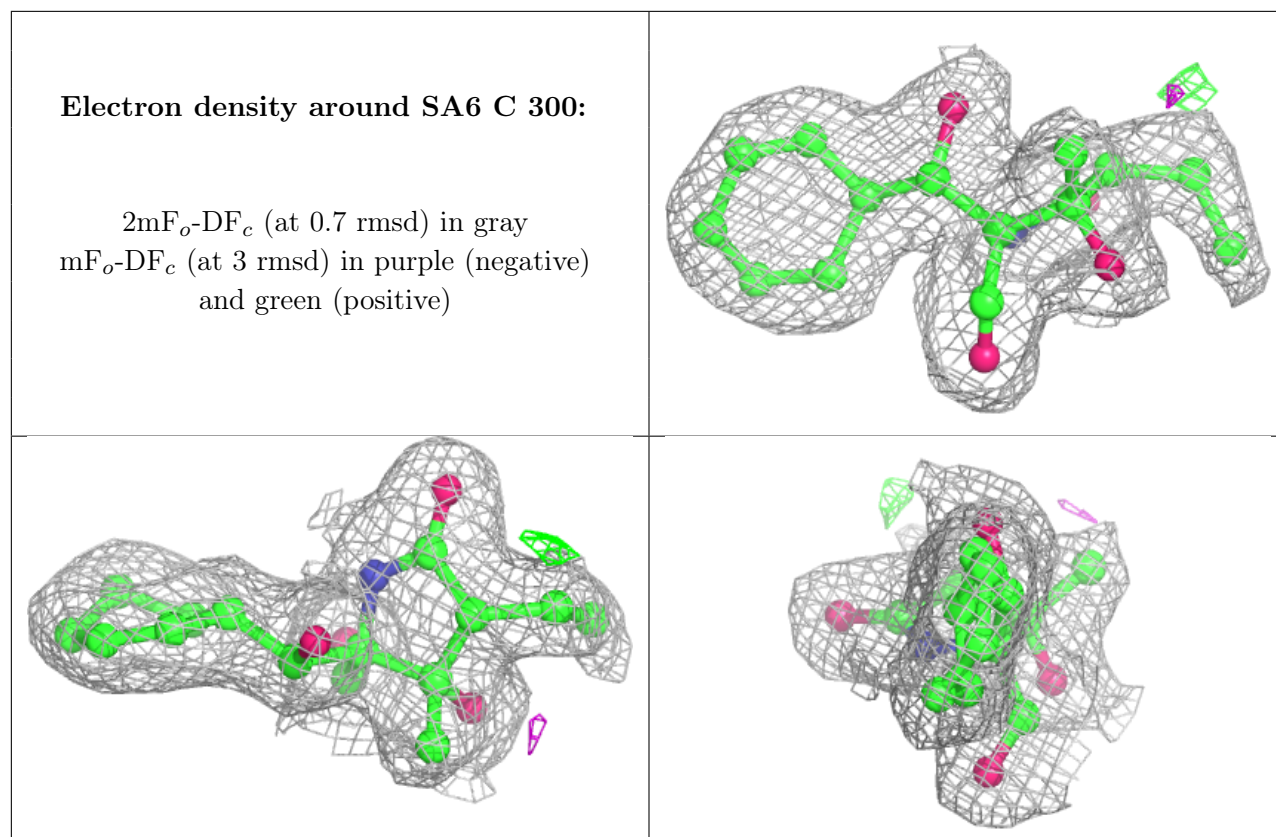

6.5 Other polymers [i](#)

There are no such residues in this entry.