



Full wwPDB EM Validation Report ⓘ

Aug 2, 2023 – 01:00 PM JST

PDB ID : 8J07
EMDB ID : EMD-35888
Title : 96nm repeat of human respiratory doublet microtubule and associated axonemal complexes
Authors : Gui, M.; Brown, A.
Deposited on : 2023-04-09
Resolution : 4.10 Å(reported)

This is a Full wwPDB EM Validation Report for a publicly released PDB entry.

We welcome your comments at validation@mail.wwpdb.org

A user guide is available at

<https://www.wwpdb.org/validation/2017/EMValidationReportHelp>

with specific help available everywhere you see the ⓘ symbol.

The types of validation reports are described at

<http://www.wwpdb.org/validation/2017/FAQs#types>.

The following versions of software and data (see [references ⓘ](#)) were used in the production of this report:

EMDB validation analysis : 0.0.1.dev50
MolProbity : 4.02b-467
Percentile statistics : 20191225.v01 (using entries in the PDB archive December 25th 2019)
MapQ : 1.9.9
Ideal geometry (proteins) : Engh & Huber (2001)
Ideal geometry (DNA, RNA) : Parkinson et al. (1996)
Validation Pipeline (wwPDB-VP) : 2.34

1 Overall quality at a glance











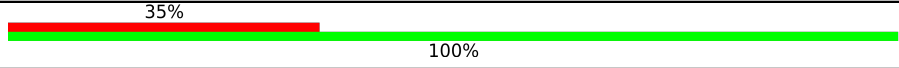
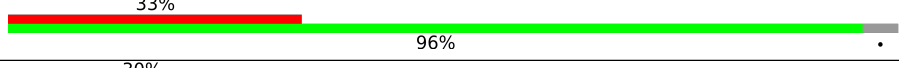

The following experimental techniques were used to determine the structure:

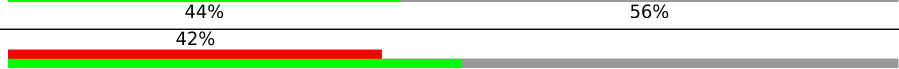
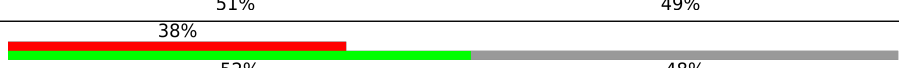
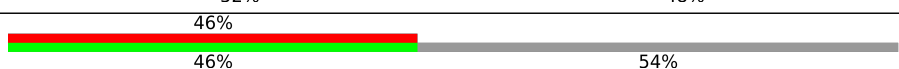
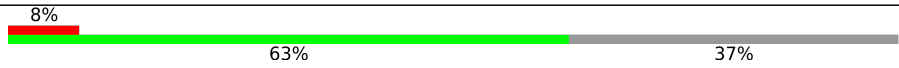
ELECTRON MICROSCOPY

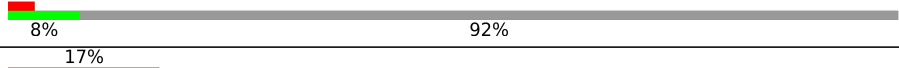
The reported resolution of this entry is 4.10 Å.

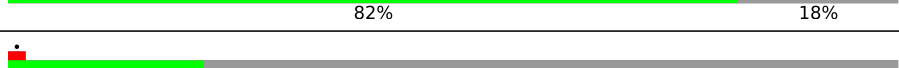
There are no overall percentile quality scores available for this entry.

The table below summarises the geometric issues observed across the polymeric chains and their fit to the map. The red, orange, yellow and green segments of the bar indicate the fraction of residues that contain outliers for ≥ 3 , 2, 1 and 0 types of geometric quality criteria respectively. A grey segment represents the fraction of residues that are not modelled. The numeric value for each fraction is indicated below the corresponding segment, with a dot representing fractions $\leq 5\%$. The upper red bar (where present) indicates the fraction of residues that have poor fit to the EM map (all-atom inclusion $< 40\%$). The numeric value is given above the bar.

Mol	Chain	Length	Quality of chain
1	0	478	
1	4	478	
2	1	740	
3	10	449	
4	11	822	
5	12	269	
5	13	269	
5	14	269	
5	8	269	
6	1A	833	
6	1B	833	
6	1C	833	
7	1D	551	
7	1E	551	
7	1F	551	
7	1G	551	
7	1H	551	

Continued on next page...

Continued from previous page...

Mol	Chain	Length	Quality of chain
7	1I	551	24% 83% 17%
7	1J	551	17% 60% 40%
8	1L	620	98%
8	1M	620	98%
8	1N	620	98%
8	1O	620	98%
8	1P	620	98%
8	1Q	620	5% 98%
9	1R	514	5% 36% 64%
9	1S	514	12% 90% 10%
9	1T	514	64% 36%
10	1V	229	13% 64% 36%
10	1W	229	12% 64% 36%
11	1Y	194	8% 89% 10%
11	1Z	194	8% 89% 11%
12	2	484	39% 96%
13	2A	177	66% 34%
13	2B	177	66% 34%
13	2C	177	66% 34%
13	2D	177	66% 34%
13	2E	177	66% 34%
13	2F	177	66% 34%
13	2G	177	45% 55%
14	2I	101	5% 50% 50%
14	2J	101	50% 50%

Continued on next page...

Continued from previous page...

Mol	Chain	Length	Quality of chain
15	2L	301	14% 92% 8%
15	2M	301	9% 92% 8%
15	2N	301	12% 92% 8%
15	2O	301	9% 92% 8%
16	2Q	552	7% 52% 48%
16	2R	552	13% 92% 8%
16	2S	552	7% 48% 52%
17	2U	169	• 66% 34%
17	2V	169	5% 66% 34%
17	2W	169	• 66% 34%
17	2X	169	• 66% 34%
17	2Y	169	• 66% 34%
17	2Z	169	• 66% 34%
18	3	523	12% 99% •
19	3A	640	• 76% 24%
19	3B	640	• 76% 24%
19	3C	640	• 76% 24%
19	3D	640	• 76% 24%
19	3E	640	• 76% 24%
19	3F	640	5% 76% 24%
20	3G	749	10% 82% 18%
20	3H	749	11% 94% 6%
20	3I	749	11% 94% 6%
20	3J	749	8% 94% 6%
20	3K	749	9% 94% 6%











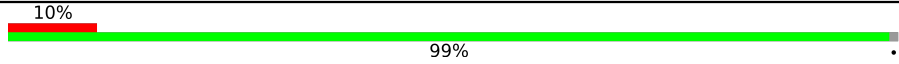
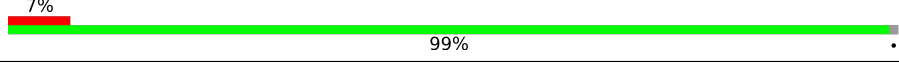
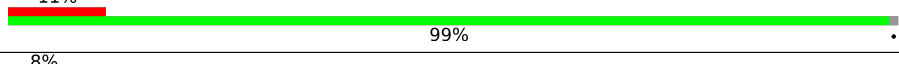
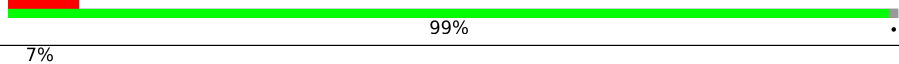

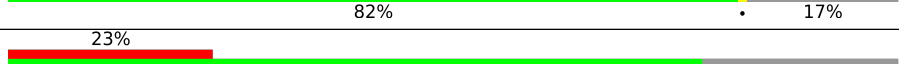
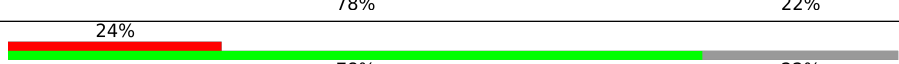
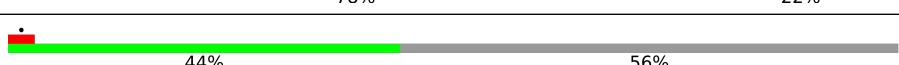

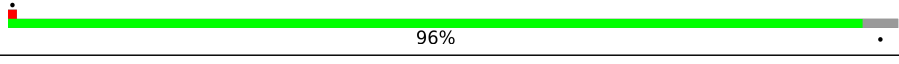

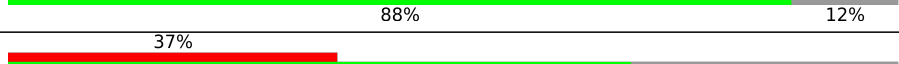
Continued on next page...

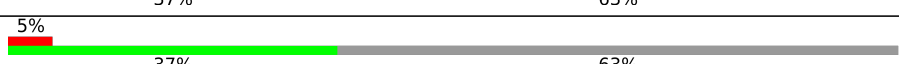
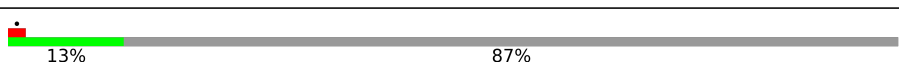
Continued from previous page...

Mol	Chain	Length	Quality of chain	
20	3L	749	23%	94% 6%
20	3M	749	11%	92% 8%
21	3O	256	11%	62% 38%
21	3P	256	13%	97% .
21	3Q	256	7%	98% .
21	3R	256	14%	98% .
21	3S	256	16%	97% .
21	3T	256	9%	98% .
21	3U	256	14%	98% .
22	3W	495	10%	79% 21%
22	3X	495	12%	97% .
22	3Y	495	5%	29% 71%
23	4A	275	.%	29% 71%
23	4B	275	46%	53% 47%
23	4C	275	17%	53% 47%
23	4D	275	39%	53% 47%
23	4E	275	11%	53% 47%
23	4F	275	50%	53% 47%
23	4G	275	13%	53% 47%
23	4H	275	46%	52% 47%
23	4I	275	13%	53% 47%
23	4J	275	28%	52% 47%
23	4K	275	24%	53% 47%
23	4L	275	52%	53% 47%
23	4M	275	19%	53% 47%

Continued on next page...

Continued from previous page...

Mol	Chain	Length	Quality of chain
24	4O	376	
24	4P	376	
24	4Q	376	
24	4R	376	
25	4S	136	
25	4T	136	
26	4U	121	
26	4V	121	
26	4W	121	
27	5	501	
28	5A	382	
28	5B	382	
28	5C	382	
29	5D	379	
29	5E	379	
29	5F	379	
30	5H	485	
30	5I	485	
30	5J	485	
31	5L	150	
31	5M	150	
32	5O	284	
32	5P	284	
32	5Q	284	
32	5R	284	

Continued on next page...

Continued from previous page...

Mol	Chain	Length	Quality of chain
32	5S	284	9% 80% 20%
32	5T	284	10% 79% 21%
32	5U	284	11% 80% 20%
32	5V	284	23% 77%
33	5X	147	86% 14%
33	5Y	147	5% 86% 14%
34	6A	222	14% 71% 29%
34	6C	222	35% 71% 28%
34	6E	222	17% 71% 29%
34	6G	222	37% 71% 29%
34	6I	222	40% 70% 29%
34	6K	222	48% 70% 29%
34	6L	222	14% 71% 29%
34	6N	222	33% 72% 28%
34	6O	222	17% 71% 29%
34	6Q	222	27% 71% 29%
34	6R	222	31% 71% 29%
34	6T	222	44% 71% 29%
34	6V	222	16% 71% 29%
35	7	874	35% 69% 31%
36	7A	201	17% 30% 70%
36	7B	201	33% 51% 49%
36	7C	201	42% 51% 49%
36	7D	201	13% 50% 50%
36	7E	201	30% 51% 49%

Continued on next page...

Continued from previous page...

Mol	Chain	Length	Quality of chain
36	7F	201	
36	7G	201	
37	7I	134	
37	7J	134	
38	8A	418	
38	8B	418	
38	8C	418	
38	8D	418	
38	8E	418	
38	8F	418	
38	8G	418	
38	8H	418	
39	8J	430	
39	8K	430	
39	8L	430	
39	8M	430	
39	8N	430	
39	8O	430	
39	8P	430	
39	8Q	430	
40	9	443	
41	A	309	
41	B	309	
41	C	309	
41	D	309	



Continued on next page...

Continued from previous page...

Mol	Chain	Length	Quality of chain
41	a	309	
41	b	309	
41	c	309	
41	d	309	
42	AC	451	
42	AE	451	
42	AG	451	
42	AI	451	
42	AK	451	
42	AM	451	
42	AO	451	
42	AQ	451	
42	AS	451	
42	AU	451	
42	AW	451	
42	AY	451	
42	AZ	451	
42	BA	451	
42	BC	451	
42	BE	451	
42	BG	451	
42	BI	451	
42	BK	451	
42	BM	451	
42	BO	451	



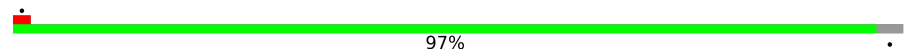
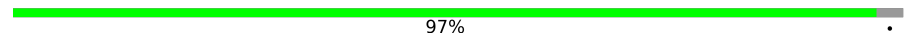
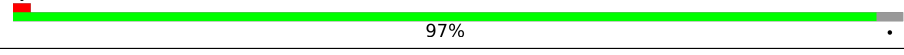
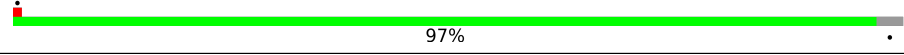
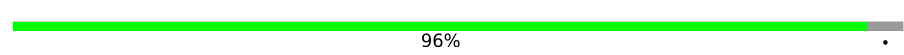

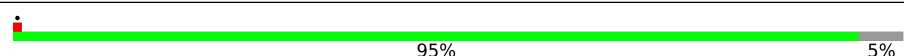
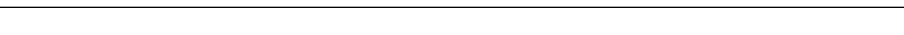
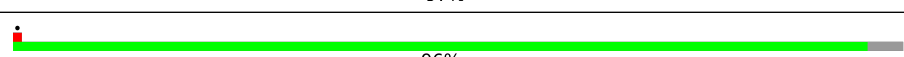
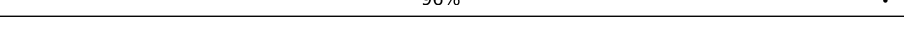
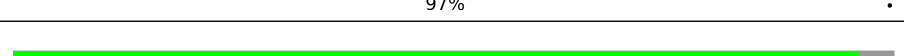
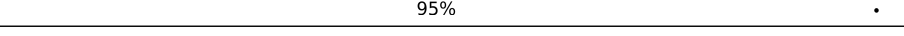
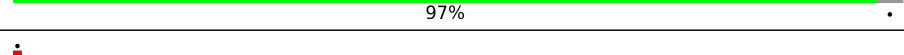
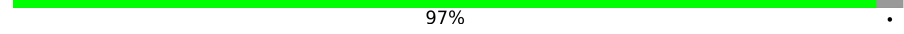
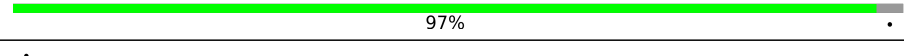
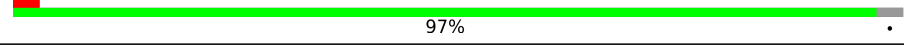
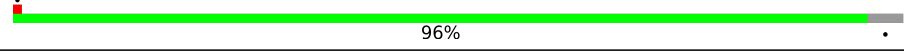
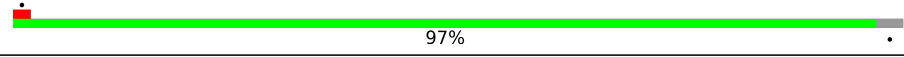
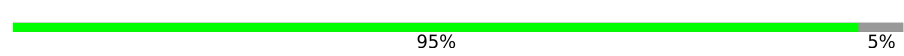
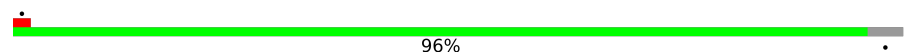
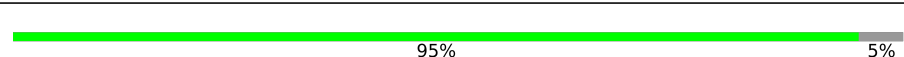
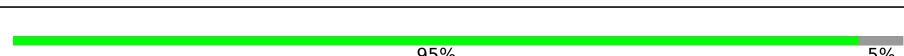
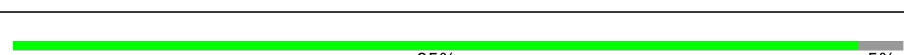
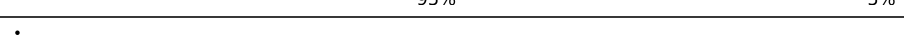
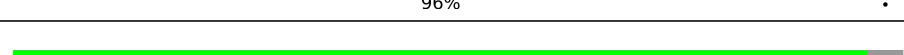

Continued on next page...

Continued from previous page...

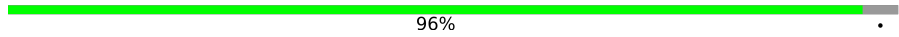
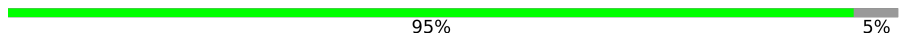
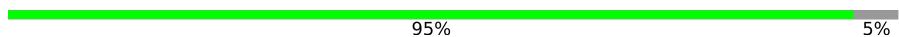
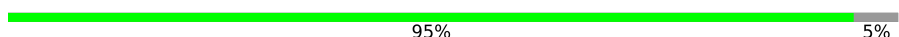
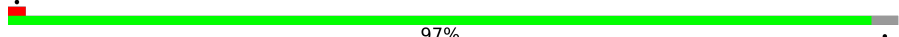
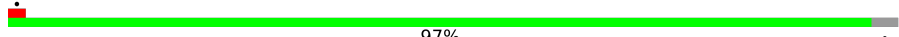
Mol	Chain	Length	Quality of chain
42	BQ	451	 97%
42	BS	451	 97%
42	BU	451	 97%
42	BW	451	 97%
42	BY	451	 96%
42	CC	451	 97%
42	CE	451	 95% 5%
42	CG	451	 97%
42	CI	451	 96%
42	CK	451	 97%
42	CM	451	 95%
42	CO	451	 97%
42	CQ	451	 97%
42	CS	451	 97%
42	CU	451	 97%
42	CW	451	 96%
42	CY	451	 97%
42	DC	451	 95% 5%
42	DE	451	 96%
42	DG	451	 95% 5%
42	DI	451	 95% 5%
42	DK	451	 95% 5%
42	DM	451	 96%
42	DO	451	 96%
42	DQ	451	 95% 5%

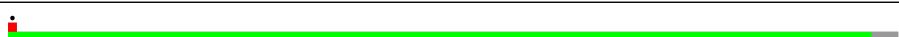

Continued on next page...

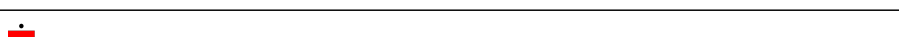
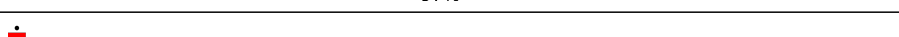
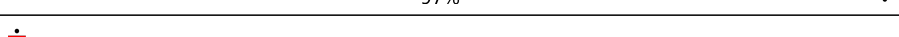
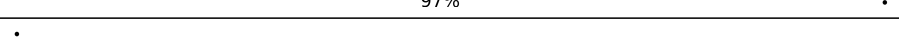
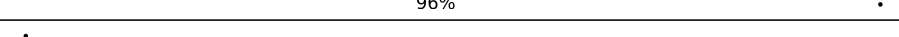
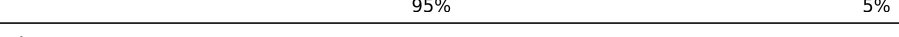
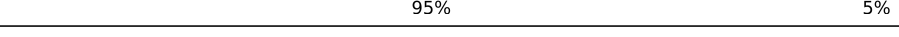
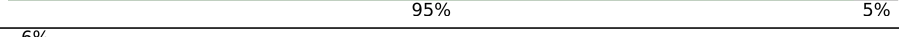
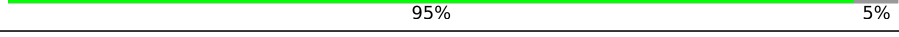
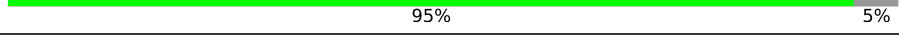
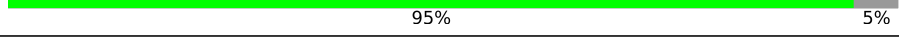
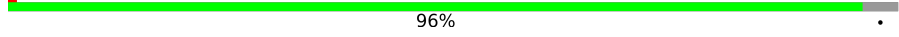
Continued from previous page...

Mol	Chain	Length	Quality of chain
42	DS	451	 96% .
42	DU	451	 95% 5% .
42	DW	451	 95% 5% .
42	DY	451	 95% 5% .
42	EC	451	 97% .
42	EE	451	 97% .
42	EG	451	 97% .
42	EI	451	 97% .
42	EK	451	 97% .
42	EM	451	 97% .
42	EO	451	 97% .
42	EQ	451	 97% .
42	ES	451	 97% .
42	EU	451	 97% .
42	EW	451	 97% .
42	EY	451	 97% .
42	FC	451	 96% .
42	FE	451	 95% 5% .
42	FG	451	 95% 5% .
42	FI	451	 95% 5% .
42	FK	451	 6% 95% 5% .
42	FM	451	 95% 5% .
42	FO	451	 95% 5% .
42	FQ	451	 96% .
42	FS	451	 96% .

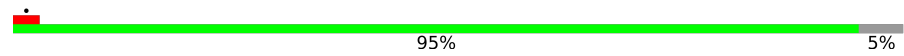
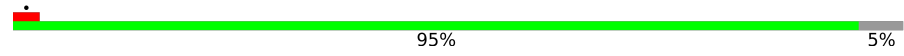
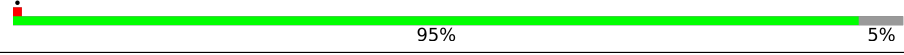
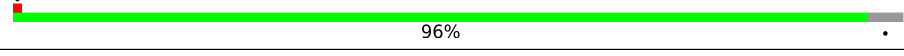
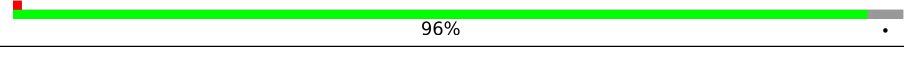
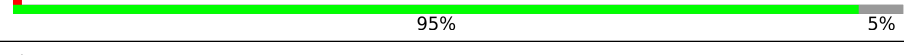
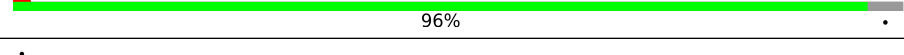
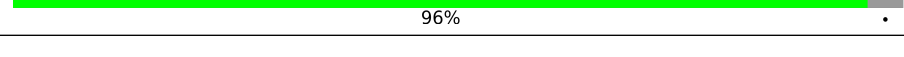
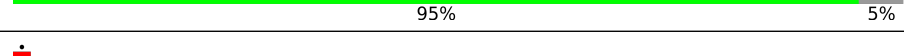
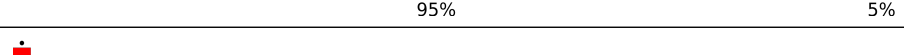
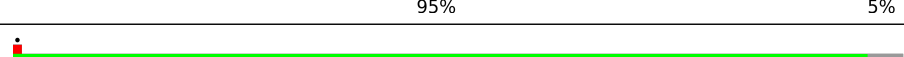
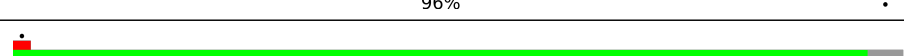
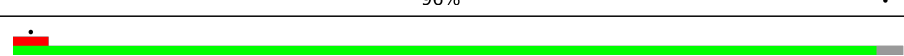
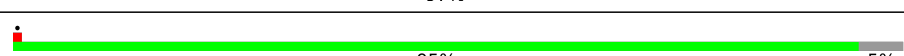
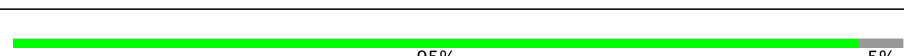
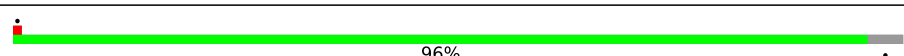
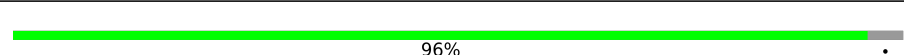
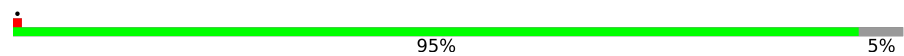
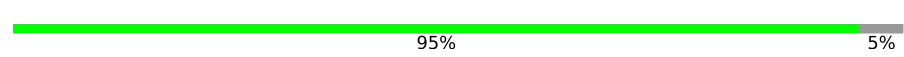
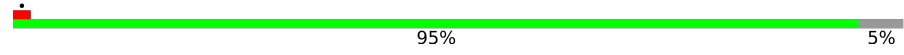
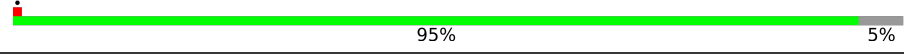
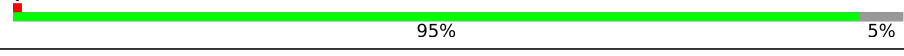
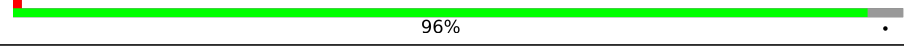
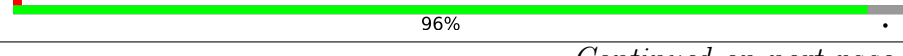

Continued on next page...

Continued from previous page...

Mol	Chain	Length	Quality of chain
42	FU	451	 95% 5%
42	FW	451	 95% 5%
42	FY	451	 95% 5%
42	GC	451	 96% .
42	GE	451	 96% .
42	GG	451	 95% 5%
42	GI	451	 96% .
42	GK	451	 96% .
42	GM	451	 95% 5%
42	GO	451	 95% 5%
42	GQ	451	 95% 5%
42	GS	451	 96% .
42	GU	451	 96% .
42	GW	451	 97% .
42	GY	451	 95% 5%
42	HA	451	 95% 5%
42	HC	451	 96% .
42	HE	451	 96% .
42	HG	451	 95% 5%
42	HI	451	 95% 5%
42	HK	451	 95% 5%
42	HM	451	 95% 5%
42	HO	451	 95% 5%
42	HQ	451	 96% .
42	HS	451	 96% .



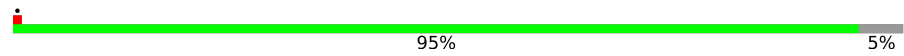
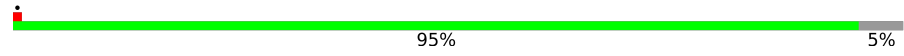
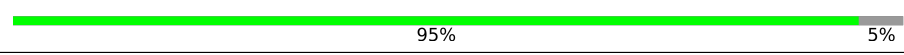
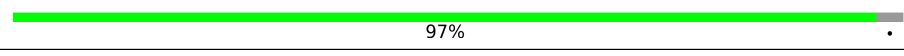
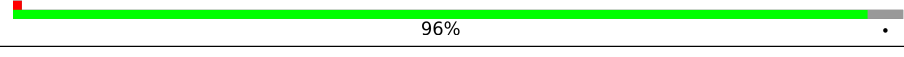
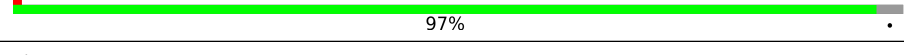
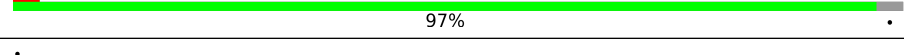
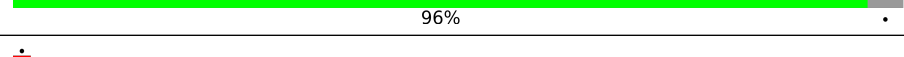
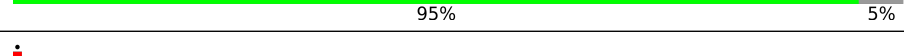
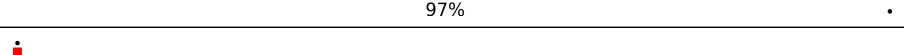
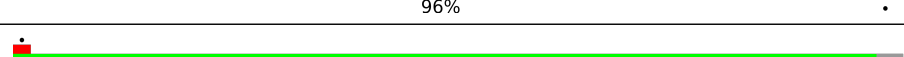
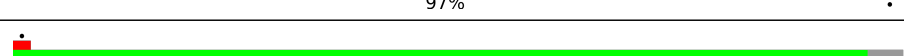
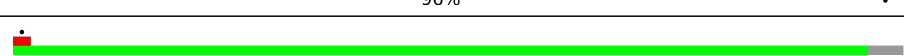
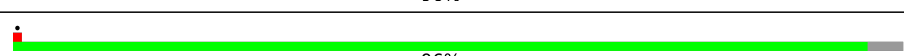
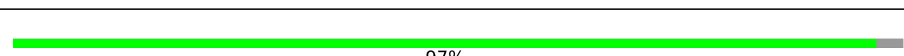
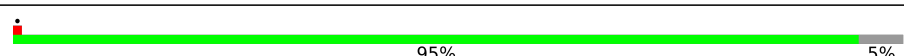
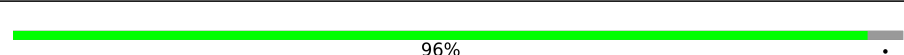
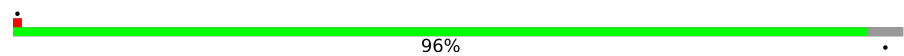
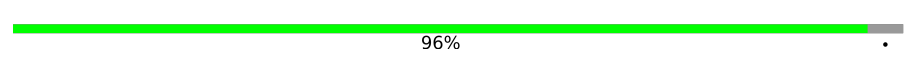
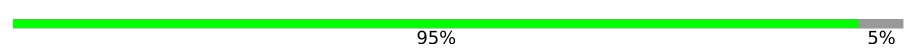
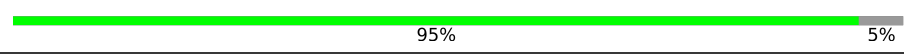
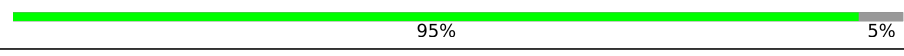
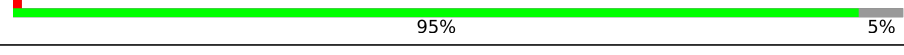
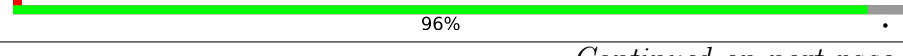



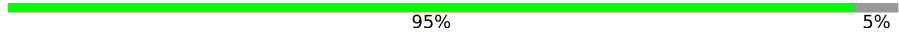
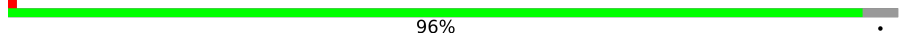
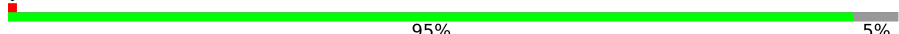
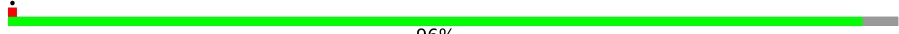

Continued on next page...

Continued from previous page...

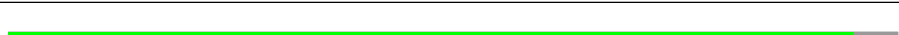
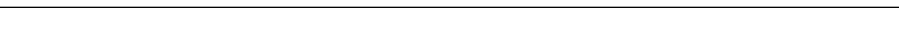
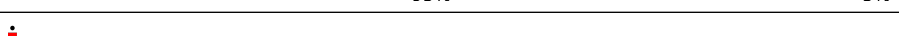
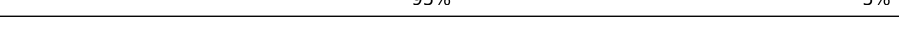
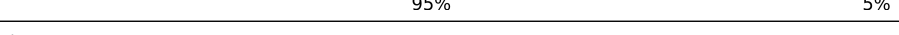
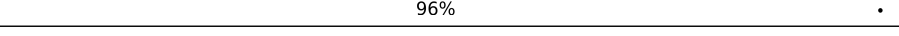
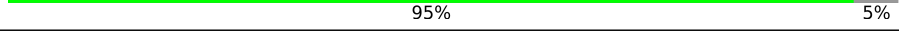
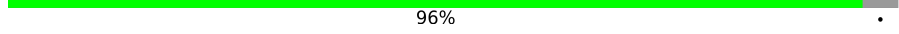
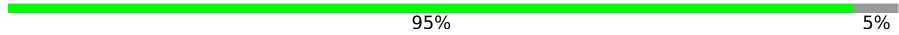
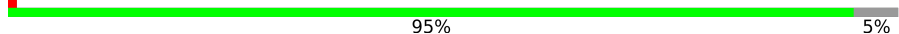
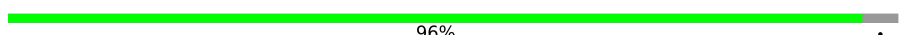
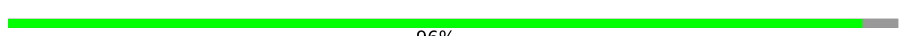
Mol	Chain	Length	Quality of chain
42	HU	451	 95% 5%
42	HW	451	 95% 5%
42	HY	451	 95% 5%
42	IA	451	 97% .
42	IC	451	 96% .
42	IE	451	 97% .
42	IG	451	 97% .
42	II	451	 96% .
42	IK	451	 95% 5%
42	IM	451	 97% .
42	IO	451	 96% .
42	IQ	451	 97% .
42	IS	451	 96% .
42	IU	451	 96% .
42	IW	451	 96% .
42	IY	451	 97% .
42	JC	451	 95% 5%
42	JE	451	 96% .
42	JG	451	 96% .
42	JI	451	 96% .
42	JK	451	 95% 5%
42	JM	451	 95% 5%
42	JO	451	 95% 5%
42	JQ	451	 95% 5%
42	JS	451	 96% .

Continued on next page...

Continued from previous page...

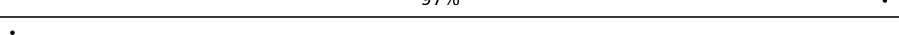
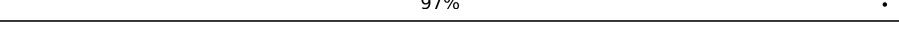
Mol	Chain	Length	Quality of chain
42	JU	451	 95% 5%
42	JW	451	 96% .
42	JY	451	 95% 5%
42	KC	451	 96% .
42	KE	451	 96% .
42	KG	451	 95% 5%
42	KI	451	 95% 5%
42	KK	451	 95% 5%
42	KM	451	 95% 5%
42	KO	451	 95% 5%
42	KQ	451	 96% .
42	KS	451	 95% 5%
42	KU	451	 96% .
42	KW	451	 95% 5%
42	KY	451	 95% 5%
42	LC	451	 96% .
42	LE	451	 96% .
42	LG	451	 96% .
42	LI	451	 96% .
42	LK	451	 96% .
42	LM	451	 97% .
42	LO	451	 97% .
42	LQ	451	 97% .
42	LS	451	 97% .
42	LU	451	 96% .

Continued on next page...

Continued from previous page...

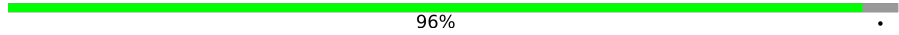
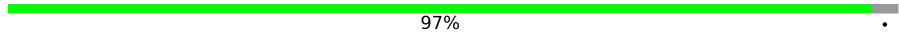
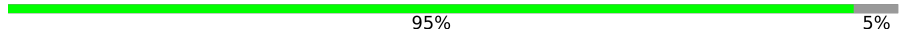
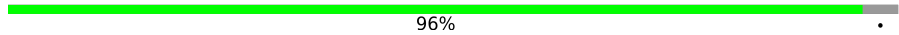
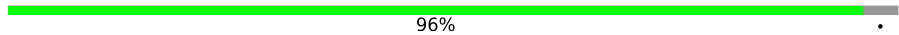
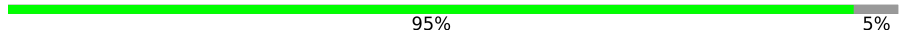
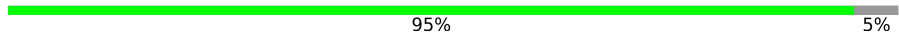
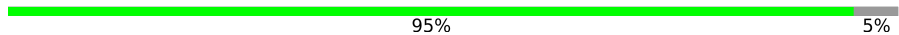
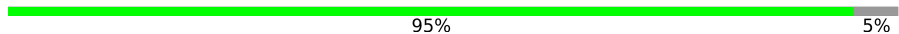
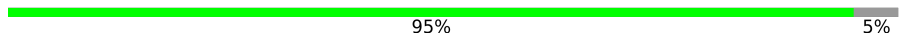
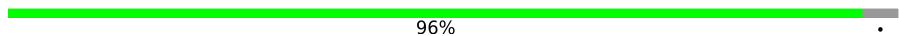
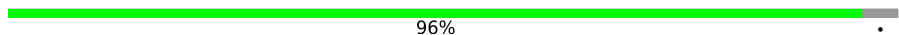
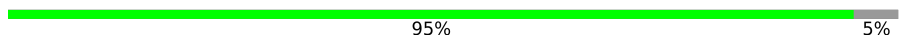
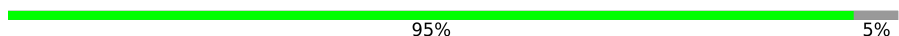
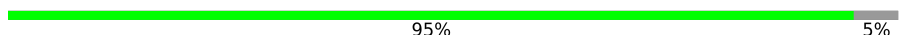
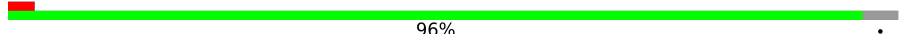
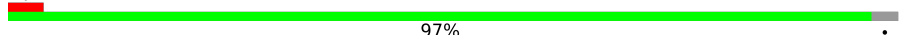
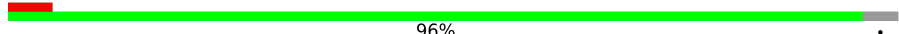
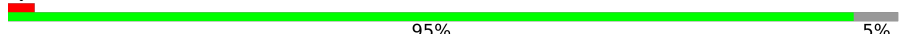
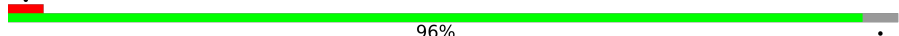
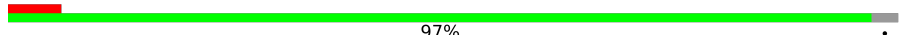
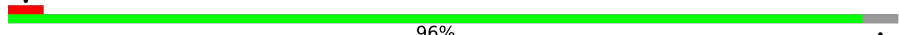
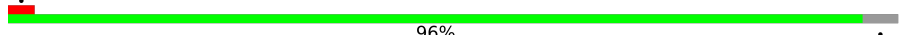
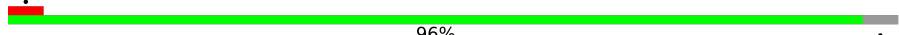
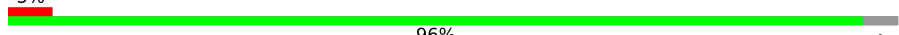
Mol	Chain	Length	Quality of chain
42	LW	451	 96% .
42	LY	451	 97% .
42	MA	451	 95% 5%
42	MC	451	 96% .
42	ME	451	 96% .
42	MG	451	 95% 5%
42	MI	451	 95% 5%
42	MK	451	 95% 5%
42	MM	451	 95% 5%
42	MO	451	 95% 5%
42	MQ	451	 96% .
42	MS	451	 96% .
42	MU	451	 95% 5%
42	MW	451	 95% 5%
42	MY	451	 95% 5%
42	NA	451	 96% .
42	NC	451	 97% .
42	NE	451	 96% .
42	NG	451	 95% 5%
42	NI	451	 96% .
42	NK	451	 97% .
42	NM	451	 96% .
42	NO	451	 96% .
42	NQ	451	 96% .
42	NS	451	 96% .

Continued on next page...

Continued from previous page...

Mol	Chain	Length	Quality of chain
42	NU	451	 5% 96% •
42	NW	451	 96% •
42	OA	451	 96% •
42	OC	451	 96% •
42	OE	451	 96% •
42	OG	451	 96% •
42	OI	451	 96% •
42	OK	451	 97% •
42	OM	451	 97% •
42	OO	451	 96% •
42	OQ	451	 96% •
42	OS	451	 96% •
42	OU	451	 96% •
42	OW	451	 96% •
42	OY	451	 96% •
42	PA	451	 95% •
42	PC	451	 96% •
42	PE	451	 96% •
42	PG	451	 95% 5%
42	PI	451	 95% 5%
42	PK	451	 95% 5%
42	PM	451	 95% 5%
42	PO	451	 95% 5%
42	PQ	451	 96% •
42	PS	451	 96% •

Continued on next page...

Continued from previous page...

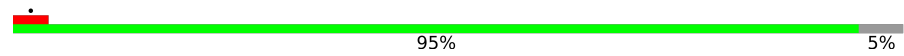
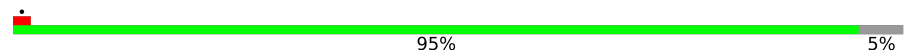
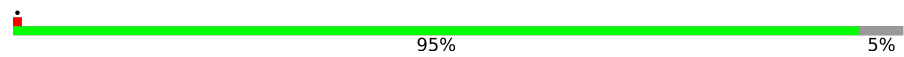
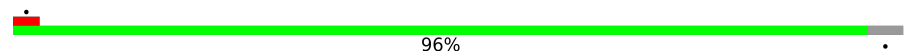
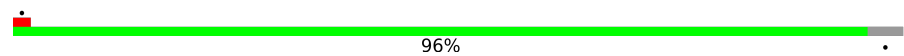
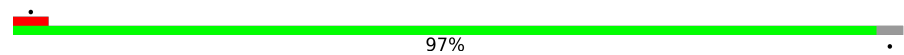
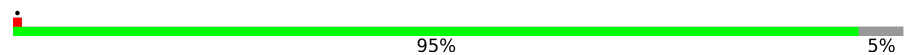
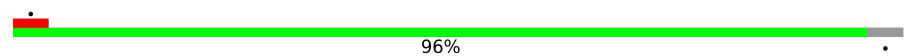
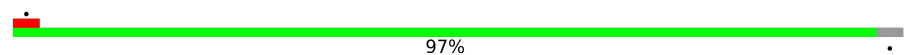
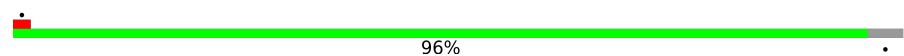
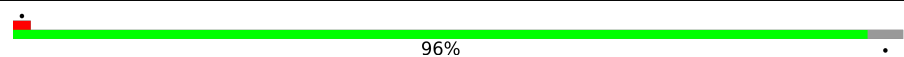
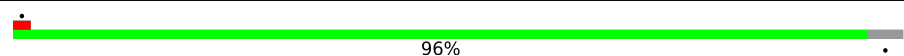
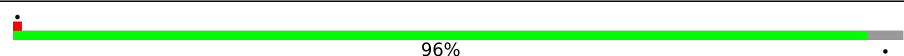
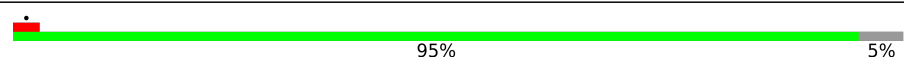
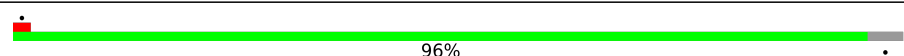
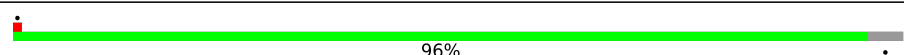
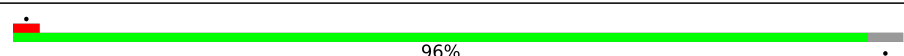
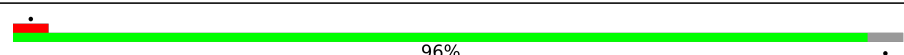
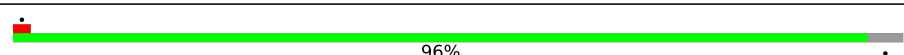
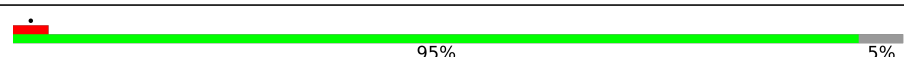
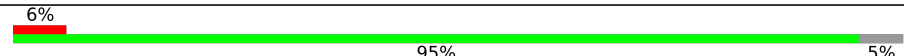
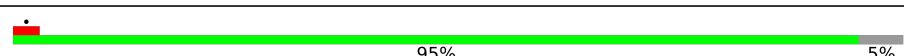
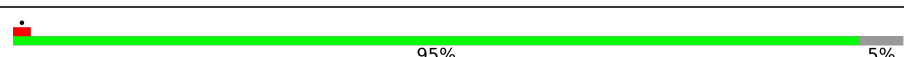
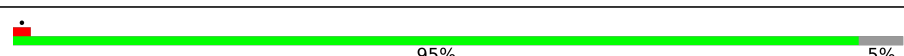
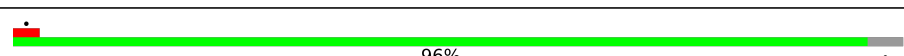
Mol	Chain	Length	Quality of chain
42	PU	451	 95% 5%
42	PW	451	 95% 5%
42	PY	451	 95% 5%
42	QA	451	 96% .
42	QC	451	 96% .
42	QE	451	 97% .
42	QG	451	 95% 5%
42	QI	451	 96% .
42	QK	451	 97% .
42	QM	451	 96% .
42	QO	451	 96% .
42	QQ	451	 96% .
42	QS	451	 96% .
42	QU	451	 95% 5%
42	QW	451	 96% .
42	QY	451	 96% .
42	RA	451	 96% .
42	RC	451	 96% .
42	RE	451	 96% .
42	RG	451	 95% 5%
42	RI	451	 6% 95% 5%
42	RK	451	 95% 5%
42	RM	451	 95% 5%
42	RO	451	 95% 5%
42	RQ	451	 96% .

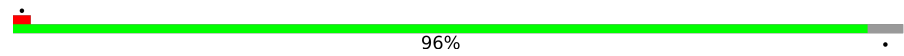
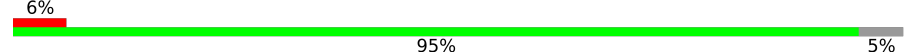
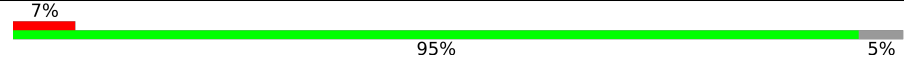
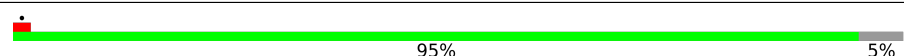
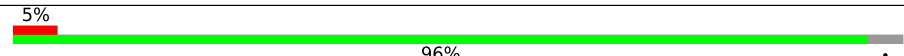
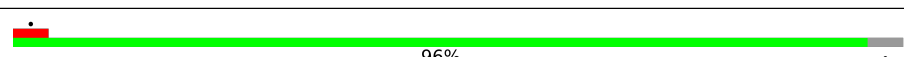
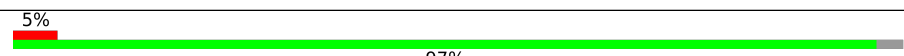
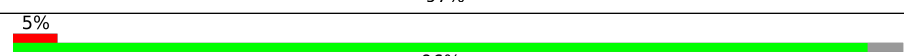
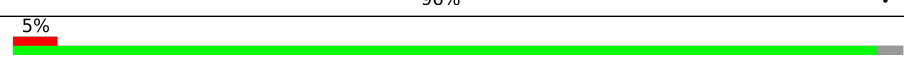
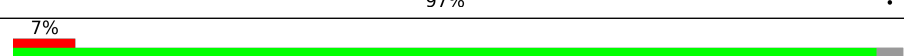
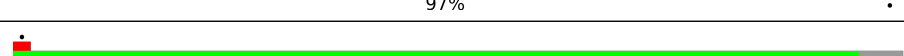
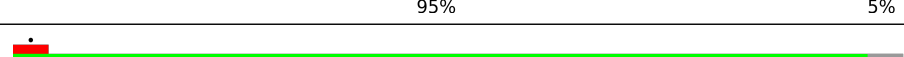
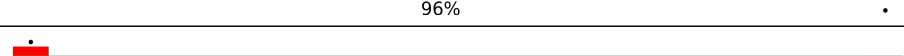
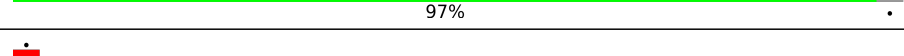
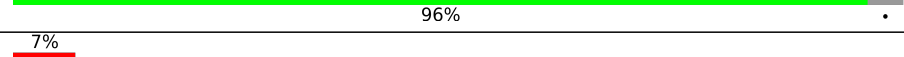
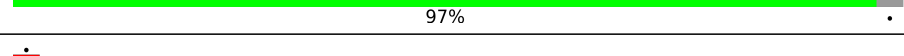
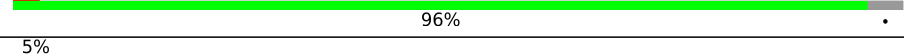
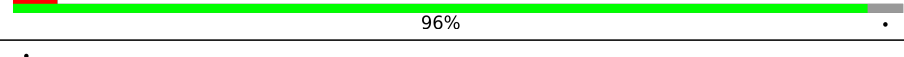
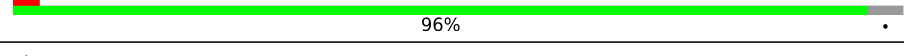
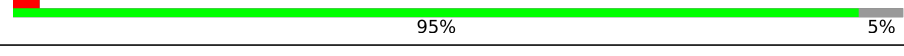
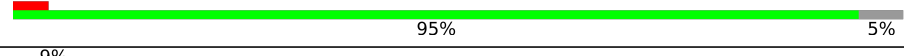
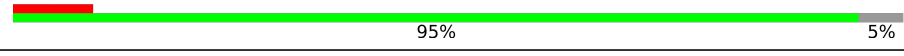
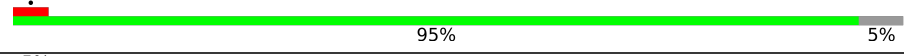
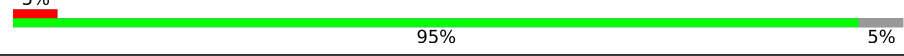
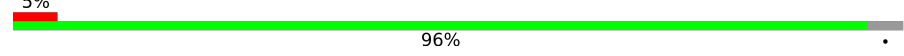

Continued on next page...

Continued from previous page...

Mol	Chain	Length	Quality of chain
42	RS	451	 96%
42	RU	451	 95%
42	RW	451	 95%
42	RY	451	 95%
42	SC	451	 96%
42	SE	451	 96%
42	SG	451	 97%
42	SI	451	 96%
42	SK	451	 97%
42	SM	451	 97%
42	SO	451	 95%
42	SQ	451	 96%
42	SS	451	 97%
42	SU	451	 96%
42	SW	451	 97%
42	SY	451	 96%
42	TC	451	 96%
42	TE	451	 96%
42	TG	451	 95%
42	TI	451	 95%
42	TK	451	 95%
42	TM	451	 95%
42	TO	451	 95%
42	TQ	451	 96%
42	TS	451	 96%

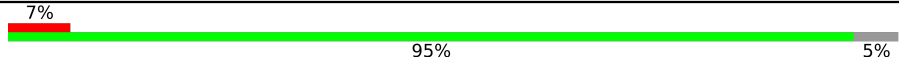
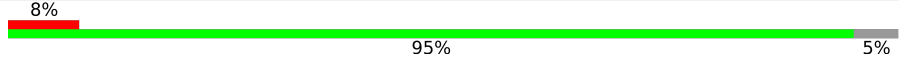
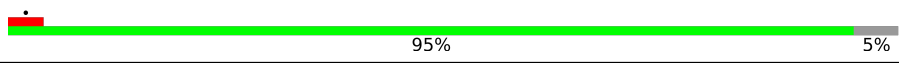
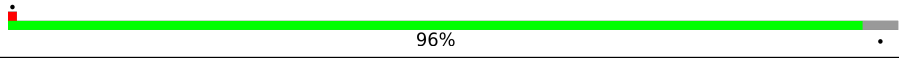
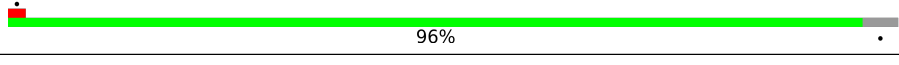
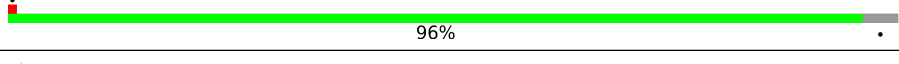
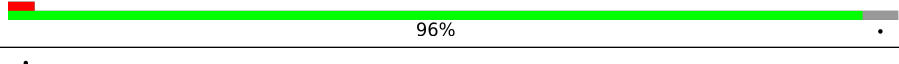
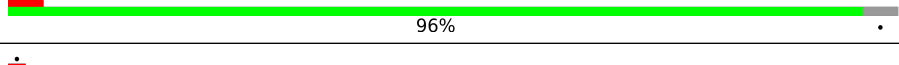
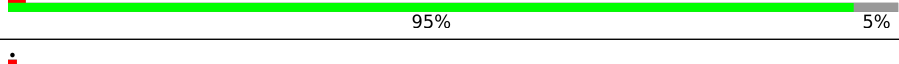
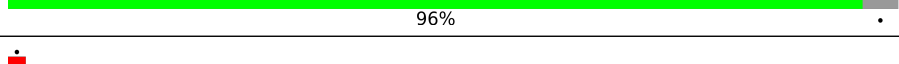
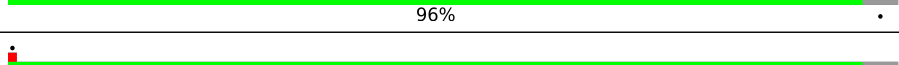
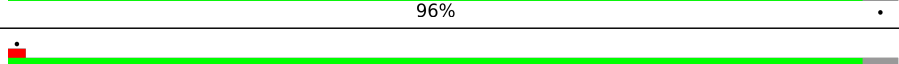
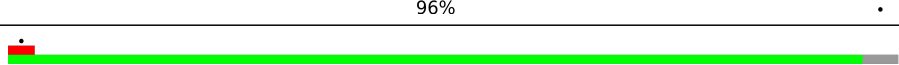
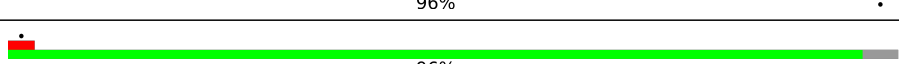
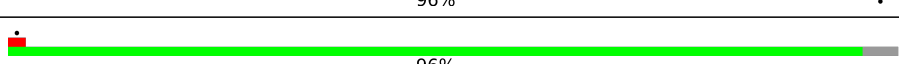
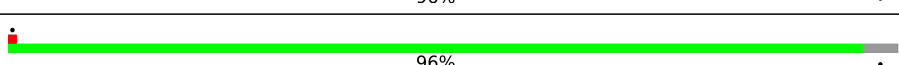
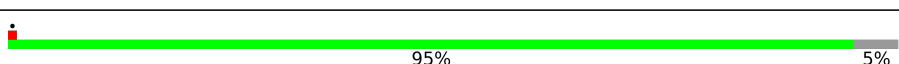
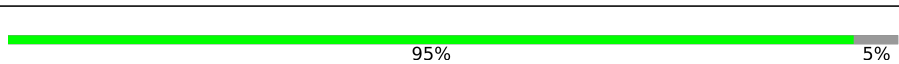
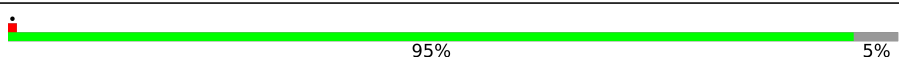
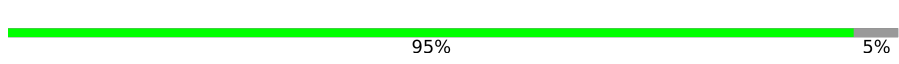
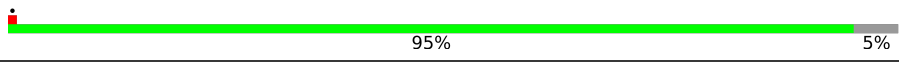
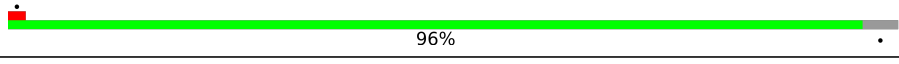
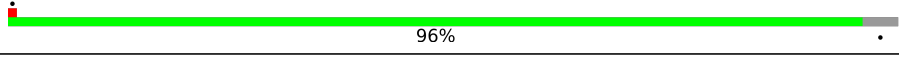
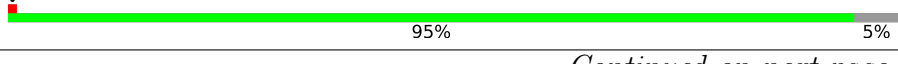

Continued on next page...

Continued from previous page...

Mol	Chain	Length	Quality of chain
42	TU	451	 7% 95% 5%
42	TW	451	 8% 95% 5%
42	TY	451	 95% 5%
42	UC	451	 96% .
42	UE	451	 96% .
42	UG	451	 96% .
42	UI	451	 96% .
42	UK	451	 96% .
42	UM	451	 95% 5%
42	UO	451	 96% .
42	UQ	451	 96% .
42	US	451	 96% .
42	UU	451	 96% .
42	UW	451	 96% .
42	UY	451	 96% .
42	VC	451	 96% .
42	VE	451	 96% .
42	VG	451	 95% 5%
42	VI	451	 95% 5%
42	VK	451	 95% 5%
42	VM	451	 95% 5%
42	VO	451	 95% 5%
42	VQ	451	 96% .
42	VS	451	 96% .
42	VU	451	 95% 5%

Continued on next page...

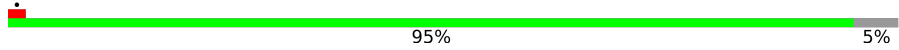
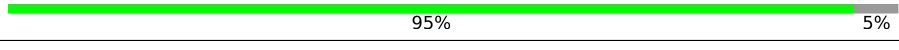
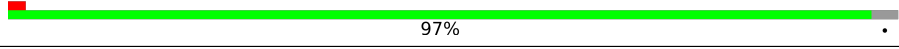
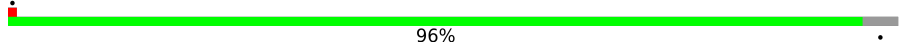
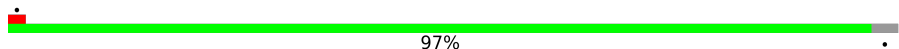
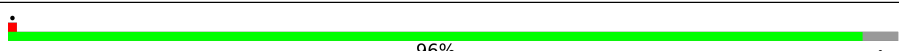
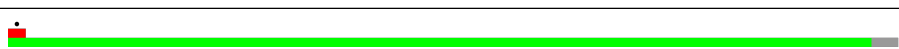
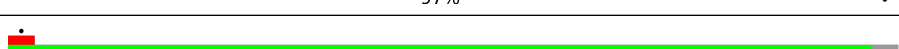
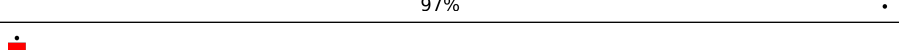
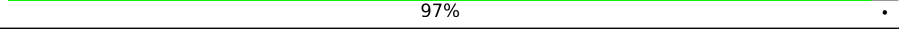
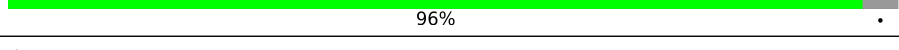
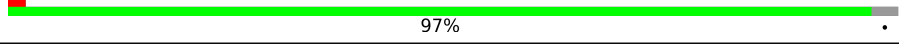
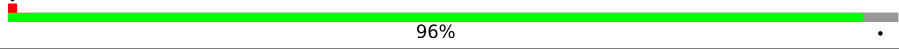
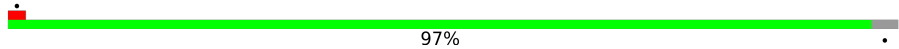
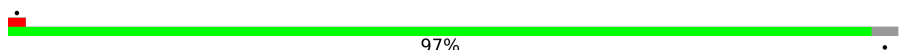
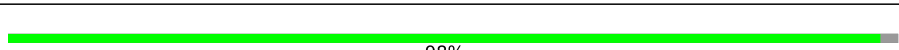
Continued from previous page...

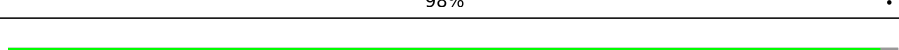
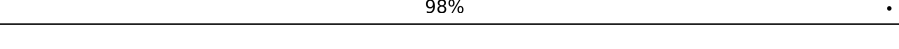
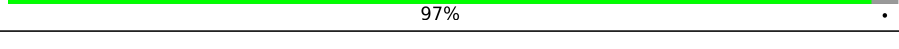
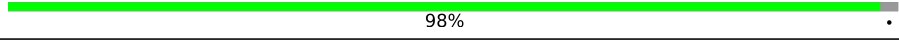
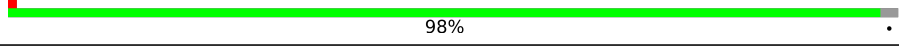
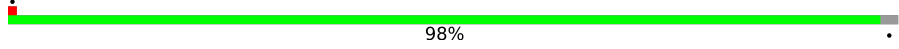
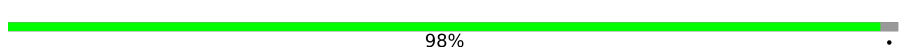
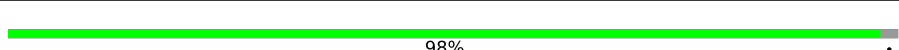
Mol	Chain	Length	Quality of chain
42	VW	451	 95% 5%
42	VY	451	 95% 5%
42	WA	451	 97% .
42	WC	451	 96% .
42	WE	451	 97% .
42	WG	451	 96% .
42	WI	451	 97% .
42	WK	451	 97% .
42	WM	451	 97% .
42	WO	451	 96% .
42	WQ	451	 97% .
42	WS	451	 96% .
42	WU	451	 97% .
42	WW	451	 97% .
43	AB	445	 98% .
43	AD	445	 98% .
43	AF	445	 98% .
43	AH	445	 97% .
43	AJ	445	 98% .
43	AL	445	 98% .
43	AN	445	 98% .
43	AP	445	 98% .
43	AR	445	 98% .
43	AT	445	 98% .
43	AV	445	 98% .





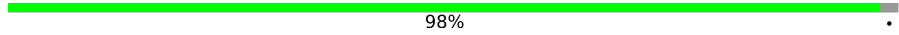
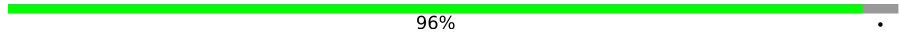
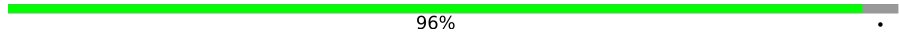
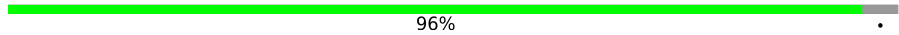
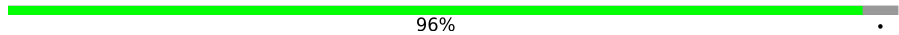
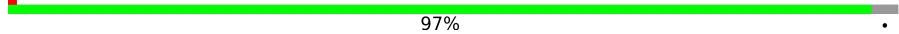
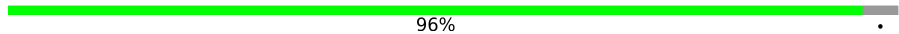
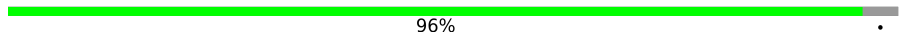
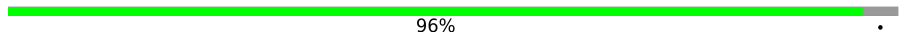
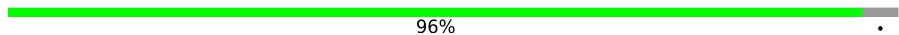
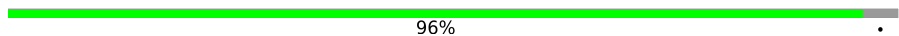
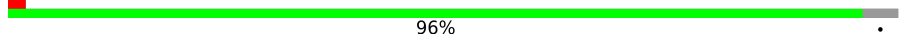
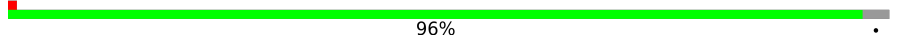
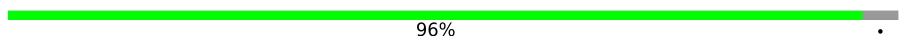
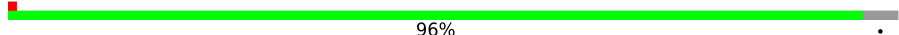
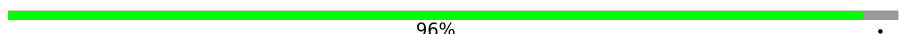
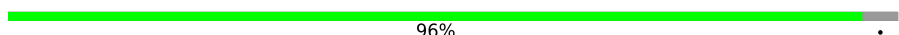
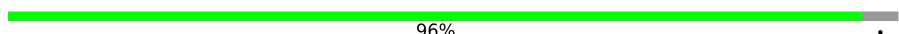
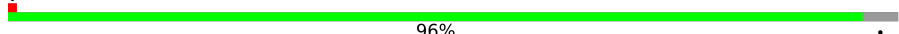
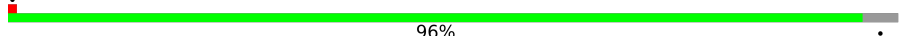
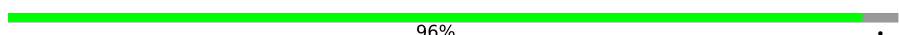
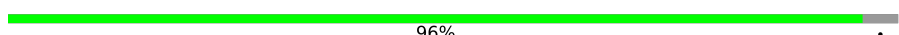
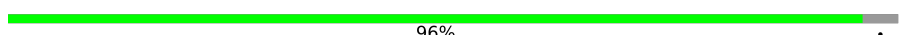
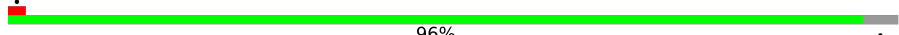
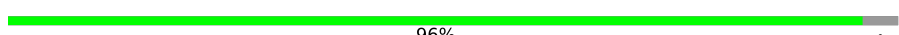

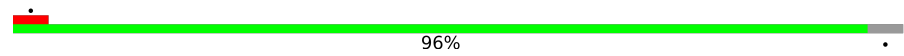
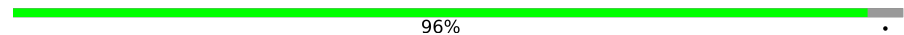
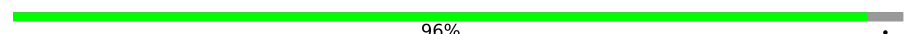
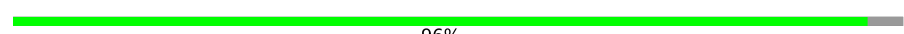

Continued on next page...

Continued from previous page...

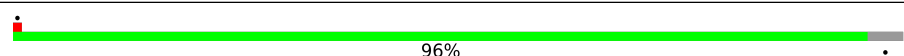
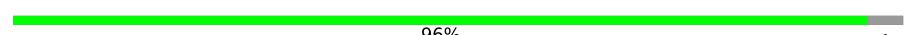
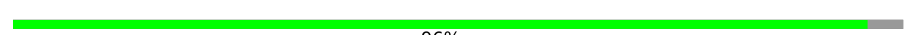
Mol	Chain	Length	Quality of chain
43	AX	445	 98%
43	BB	445	 96%
43	BD	445	 96%
43	BF	445	 96%
43	BH	445	 96%
43	BJ	445	 97%
43	BL	445	 96%
43	BN	445	 96%
43	BP	445	 96%
43	BR	445	 96%
43	BT	445	 96%
43	BV	445	 96%
43	BX	445	 96%
43	CB	445	 96%
43	CD	445	 96%
43	CF	445	 96%
43	CH	445	 96%
43	CJ	445	 96%
43	CL	445	 96%
43	CN	445	 96%
43	CP	445	 96%
43	CR	445	 96%
43	CT	445	 96%
43	CV	445	 96%
43	CX	445	 96%

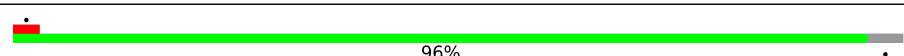
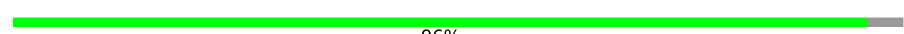
Continued on next page...

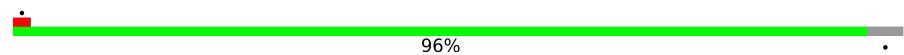
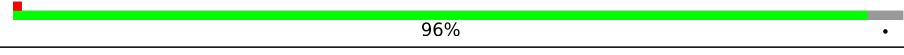
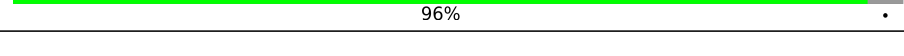
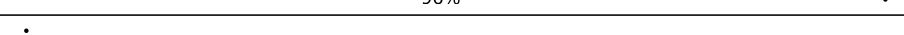
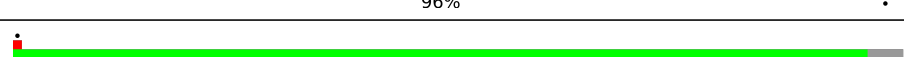
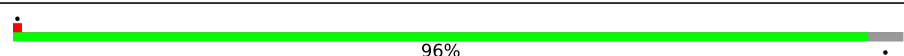
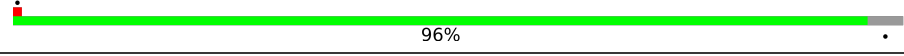
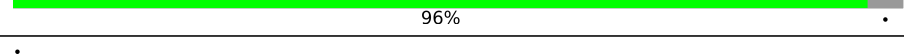
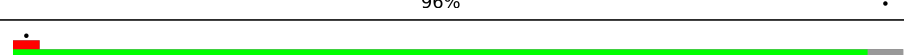
Continued from previous page...

Mol	Chain	Length	Quality of chain
43	CZ	445	 96%
43	DB	445	 96%
43	DD	445	 96%
43	DF	445	 96%
43	DH	445	 96%
43	DJ	445	 96%
43	DL	445	 96%
43	DN	445	 96%
43	DP	445	 96%
43	DR	445	 96%
43	DT	445	 96%
43	DV	445	 96%
43	DX	445	 96%
43	DZ	445	 96%
43	EB	445	 96%
43	ED	445	 96%
43	EF	445	 96%
43	EH	445	 96%
43	EJ	445	 96%
43	EL	445	 96%
43	EN	445	 96%
43	EP	445	 96%
43	ER	445	 96%
43	ET	445	 96%
43	EV	445	 96%

Continued on next page...

Continued from previous page...

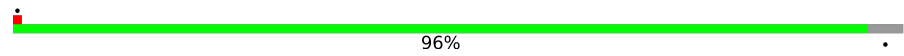
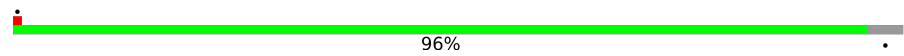
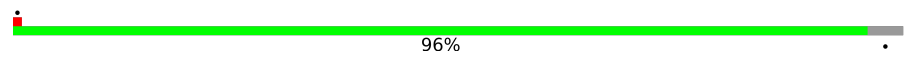
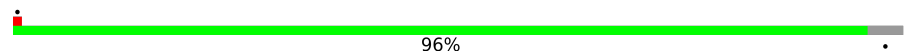
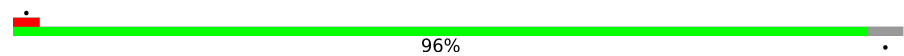
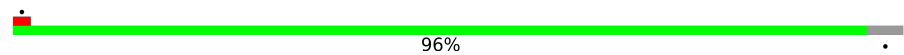
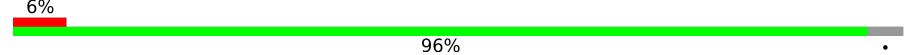
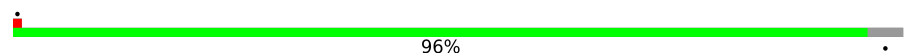
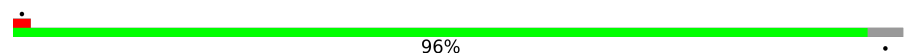
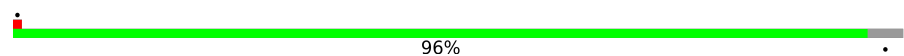
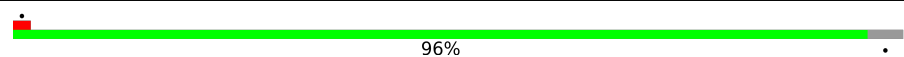
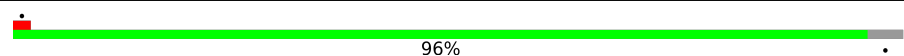
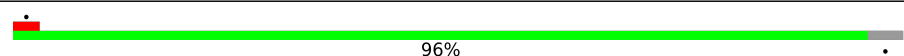
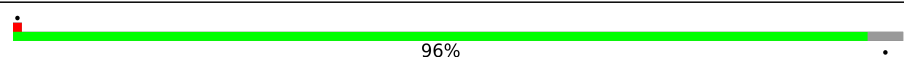
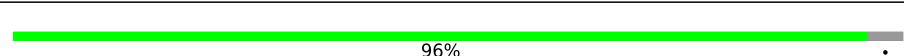
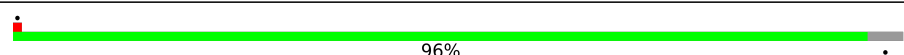
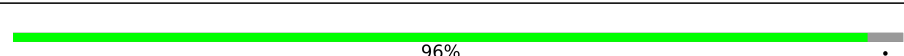
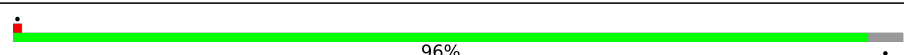
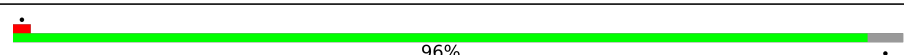
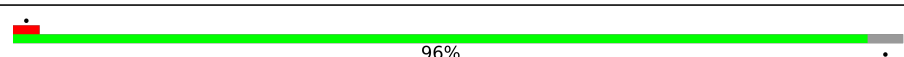
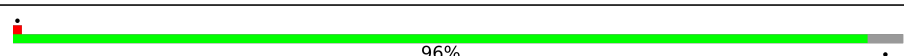
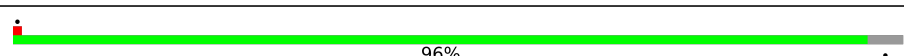
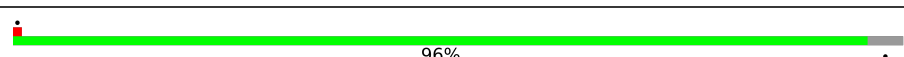
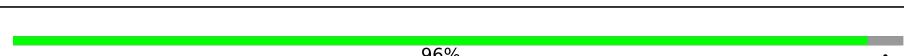
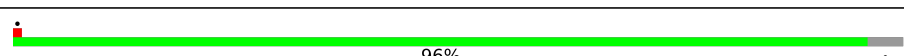
Mol	Chain	Length	Quality of chain
43	EX	445	 96%
43	EZ	445	 96%
43	FB	445	 96%
43	FD	445	 96%
43	FF	445	 96%
43	FH	445	 96%
43	FJ	445	 96%
43	FL	445	 96%
43	FN	445	 96%
43	FP	445	 96%
43	FR	445	 96%
43	FT	445	 96%
43	FV	445	 96%
43	FX	445	 96%
43	FZ	445	 96%
43	GB	445	 96%
43	GD	445	 96%
43	GF	445	 96%
43	GH	445	 96%
43	GJ	445	 96%
43	GL	445	 96%
43	GN	445	 96%
43	GP	445	 96%
43	GR	445	 96%
43	GT	445	 96%

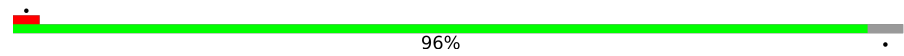
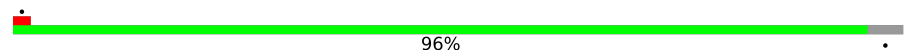
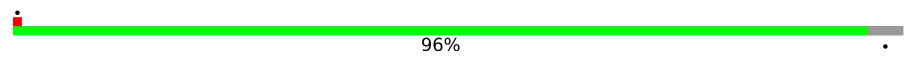
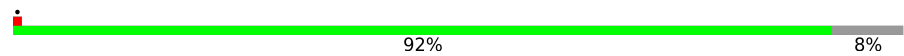
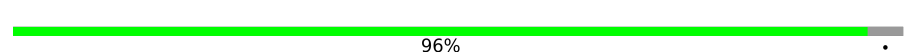
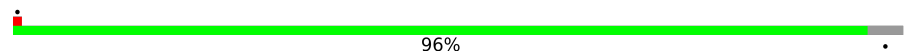
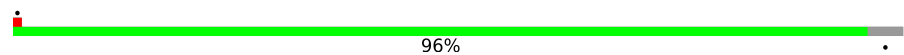
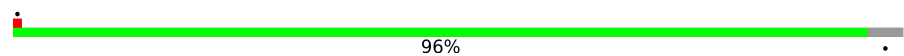
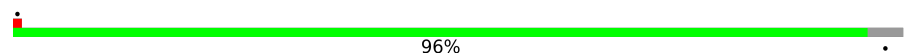
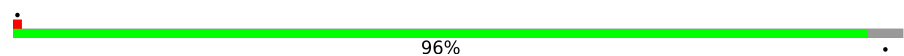
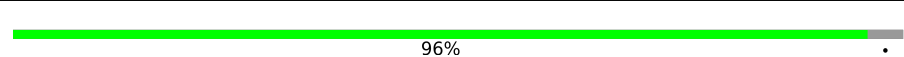
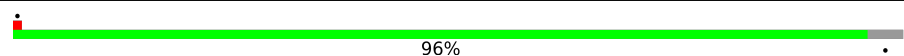
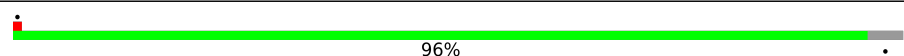
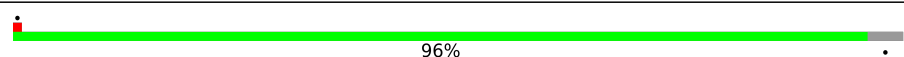
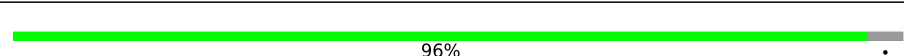
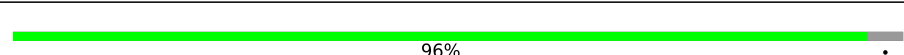
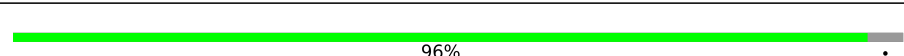
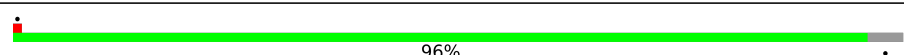
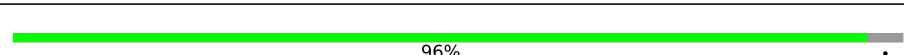
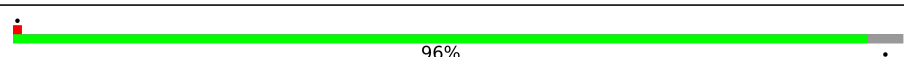
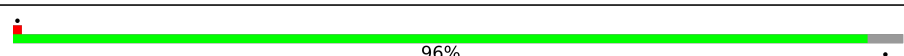
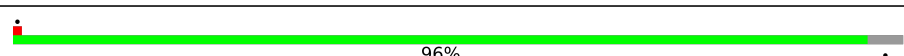
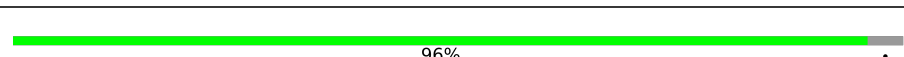
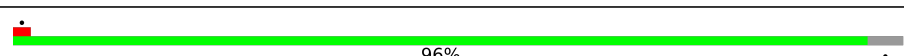
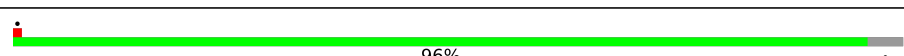

Continued on next page...

Continued from previous page...

Mol	Chain	Length	Quality of chain
43	GV	445	 96%
43	GX	445	 96%
43	GZ	445	 96%
43	HB	445	 92% 8%
43	HD	445	 96%
43	HF	445	 96%
43	HH	445	 96%
43	HJ	445	 96%
43	HL	445	 96%
43	HN	445	 96%
43	HP	445	 96%
43	HR	445	 96%
43	HT	445	 96%
43	HV	445	 96%
43	HX	445	 96%
43	HZ	445	 96%
43	IB	445	 96%
43	ID	445	 96%
43	IF	445	 96%
43	IH	445	 96%
43	IJ	445	 96%
43	IL	445	 96%
43	IN	445	 96%
43	IP	445	 96%
43	IR	445	 96%

Continued on next page...

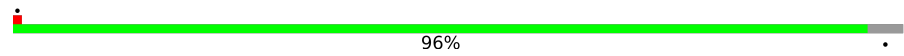
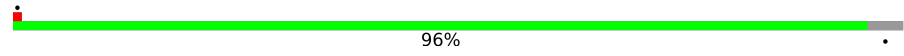
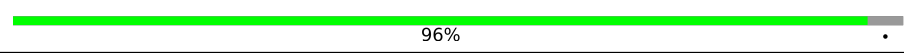
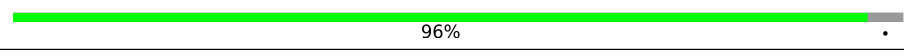
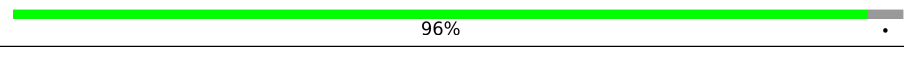
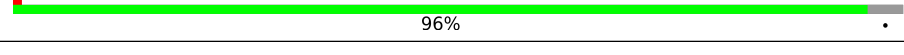
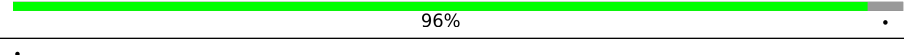
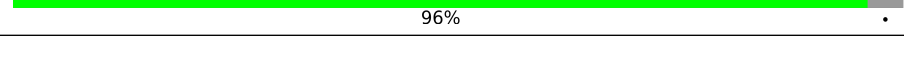
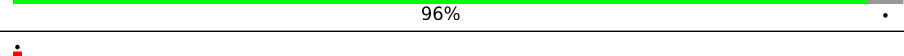
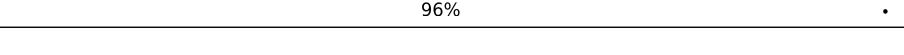
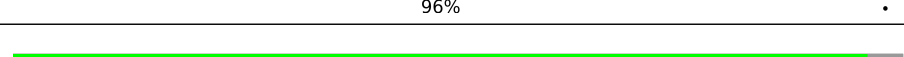
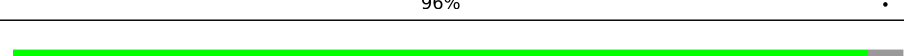
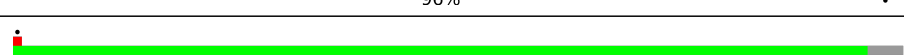
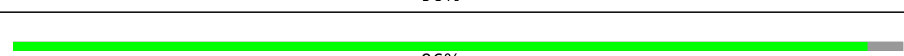
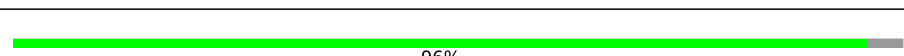
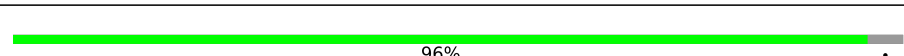
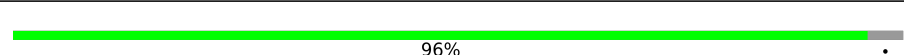
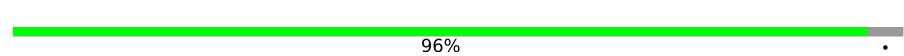
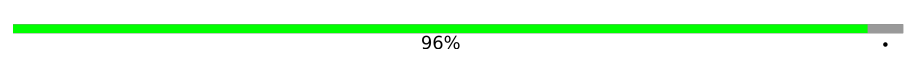
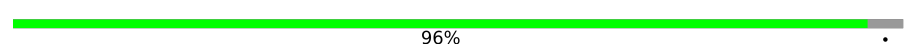
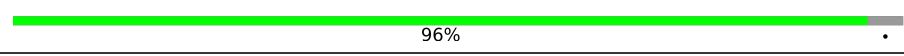
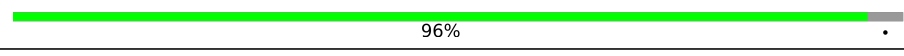
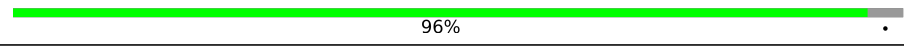
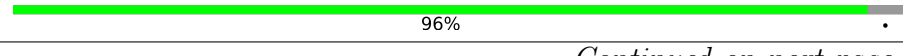
Continued from previous page...

Mol	Chain	Length	Quality of chain
43	IT	445	 96%
43	IV	445	 96%
43	IX	445	 96%
43	JB	445	 96%
43	JD	445	 96%
43	JF	445	 96%
43	JH	445	 96%
43	JJ	445	 96%
43	JL	445	 96%
43	JN	445	 96%
43	JP	445	 96%
43	JR	445	 96%
43	JT	445	 96%
43	JV	445	 96%
43	JX	445	 96%
43	JZ	445	 96%
43	KB	445	 96%
43	KD	445	 96%
43	KF	445	 96%
43	KH	445	 96%
43	KJ	445	 96%
43	KL	445	 96%
43	KN	445	 96%
43	KP	445	 96%
43	KR	445	 96%

Continued on next page...

Continued from previous page...

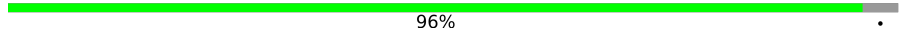
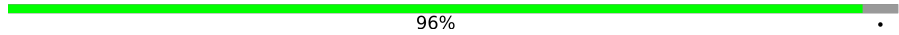
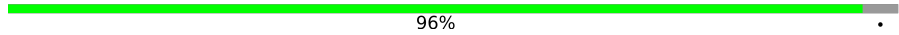
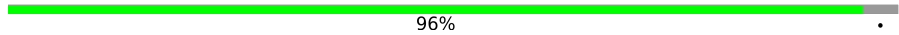
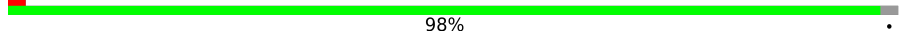
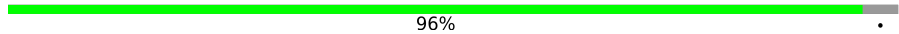
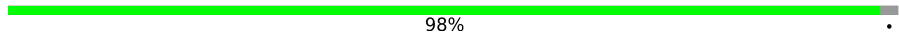
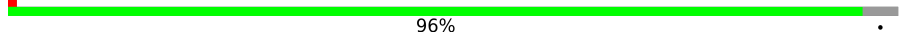
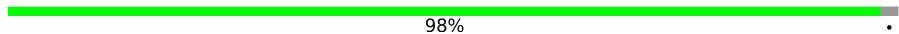
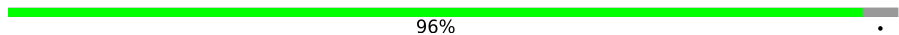
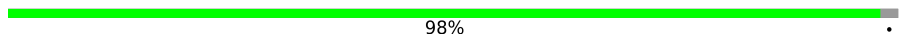
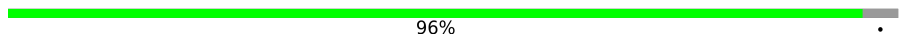
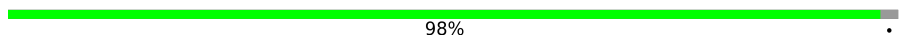
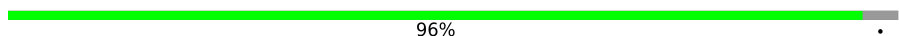
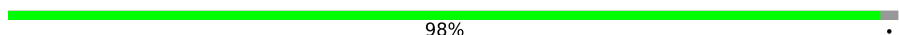
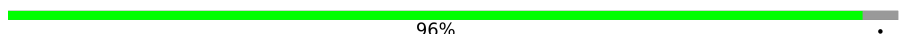
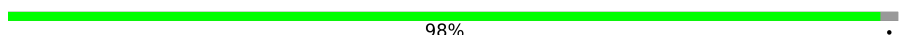
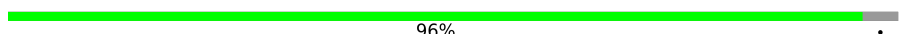
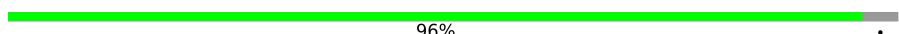
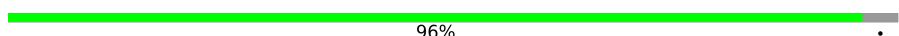
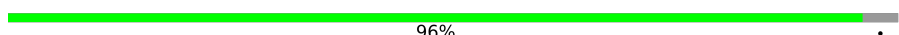
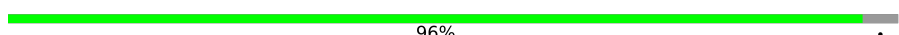
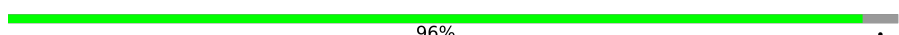
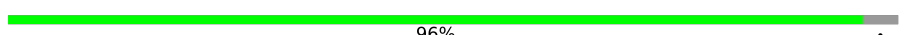
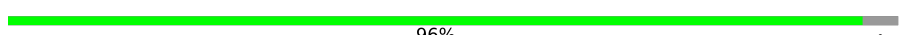
Mol	Chain	Length	Quality of chain
43	KT	445	 96%
43	KV	445	 96%
43	KX	445	 96%
43	KZ	445	 96%
43	LB	445	 98%
43	LD	445	 96%
43	LF	445	 98%
43	LH	445	 96%
43	LJ	445	 98%
43	LL	445	 96%
43	LN	445	 98%
43	LP	445	 96%
43	LR	445	 98%
43	LT	445	 96%
43	LV	445	 98%
43	LX	445	 96%
43	LZ	445	 98%
43	MD	445	 96%
43	MF	445	 96%
43	MH	445	 96%
43	MJ	445	 96%
43	ML	445	 96%
43	MN	445	 96%
43	MP	445	 96%
43	MR	445	 96%

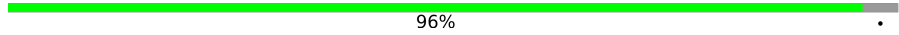
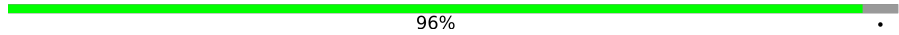
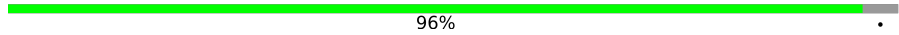
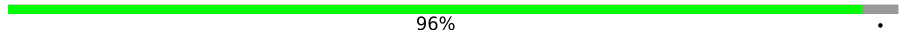
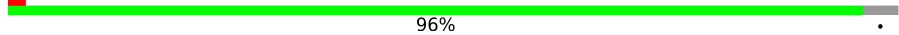
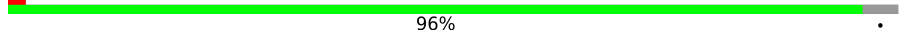
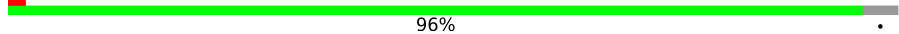
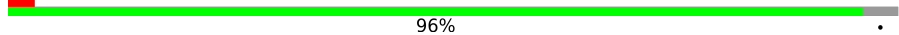
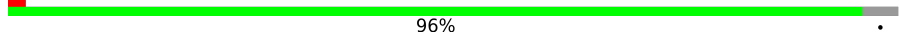
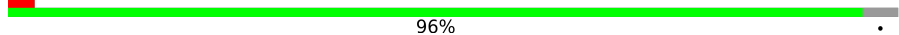
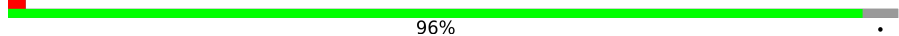
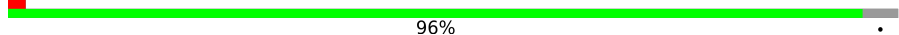
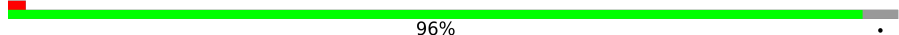
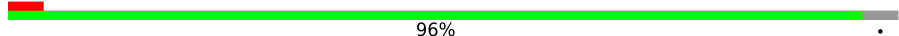
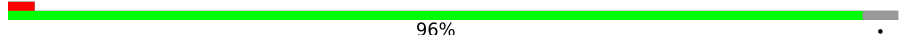
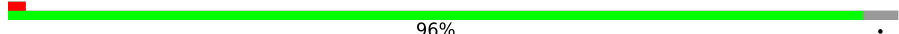
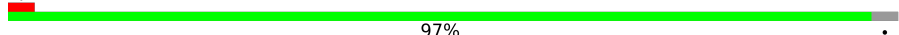
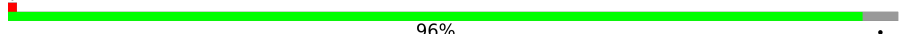
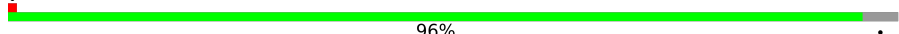
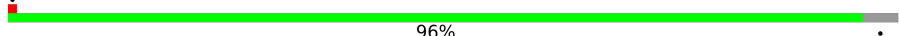
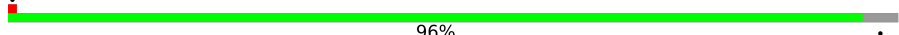
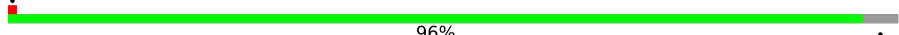
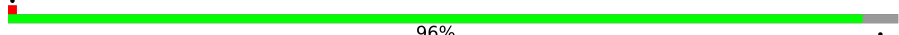
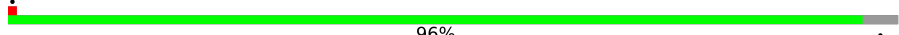
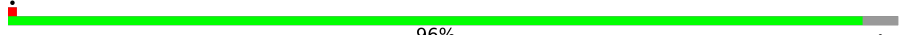

Continued on next page...

Continued from previous page...

Mol	Chain	Length	Quality of chain
43	MT	445	 96%
43	MV	445	 96%
43	MX	445	 96%
43	MZ	445	 96%
43	NB	445	 96%
43	ND	445	 96%
43	NF	445	 96%
43	NH	445	 96%
43	NJ	445	 96%
43	NL	445	 96%
43	NN	445	 96%
43	NP	445	 96%
43	NR	445	 96%
43	NT	445	 96%
43	NV	445	 96%
43	NX	445	 96%
43	NZ	445	 97%
43	OB	445	 96%
43	OD	445	 96%
43	OF	445	 96%
43	OH	445	 96%
43	OJ	445	 96%
43	OL	445	 96%
43	ON	445	 96%
43	OP	445	 96%

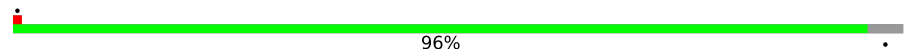
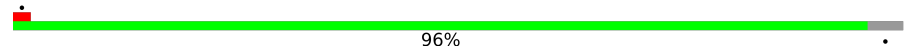
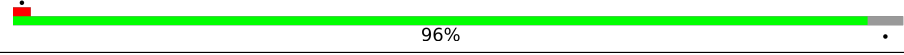
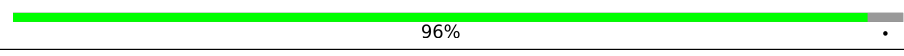
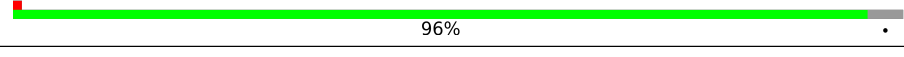
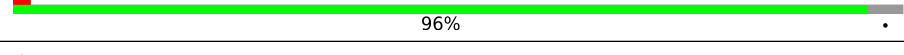
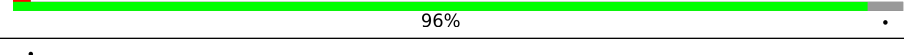
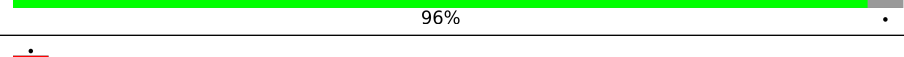
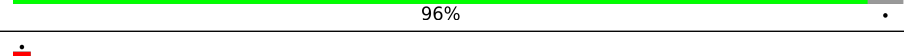
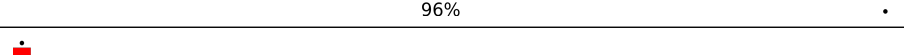
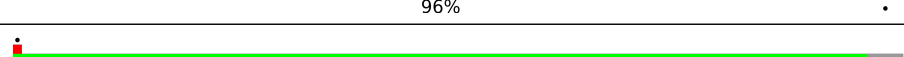
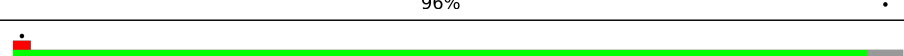
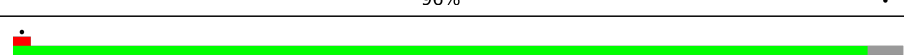
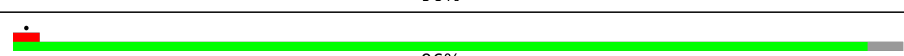
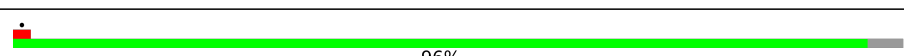
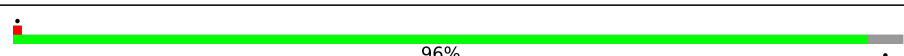
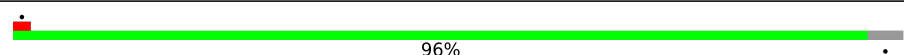
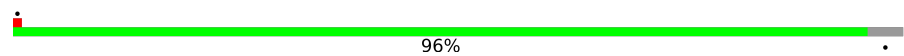
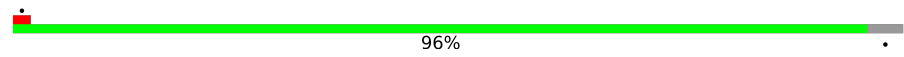
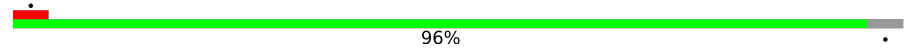
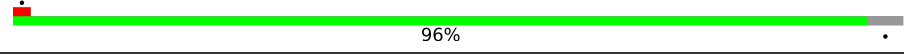
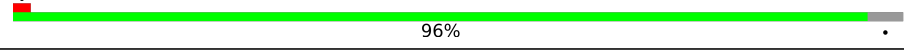
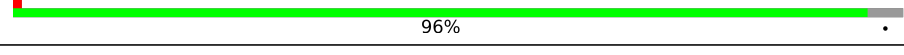
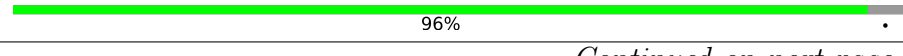

Continued on next page...

Continued from previous page...

Mol	Chain	Length	Quality of chain
43	OR	445	 96%
43	OT	445	 96%
43	OV	445	 96%
43	OX	445	 96%
43	PB	445	 96%
43	PD	445	 96%
43	PF	445	 96%
43	PH	445	 96%
43	PJ	445	 96%
43	PL	445	 96%
43	PN	445	 96%
43	PP	445	 96%
43	PR	445	 96%
43	PT	445	 96%
43	PV	445	 96%
43	PX	445	 96%
43	QB	445	 96%
43	QD	445	 96%
43	QF	445	 96%
43	QH	445	 96%
43	QJ	445	 96%
43	QL	445	 96%
43	QN	445	 96%
43	QP	445	 96%
43	QR	445	 96%

Continued on next page...

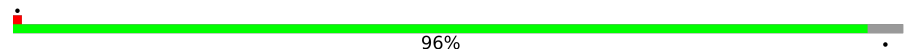
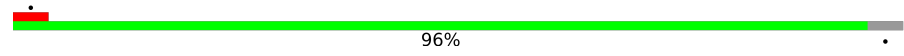
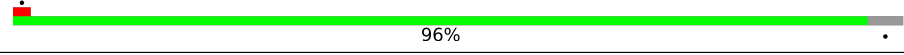
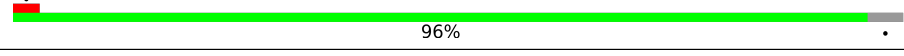
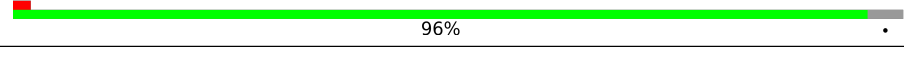
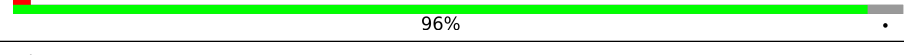
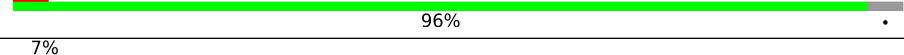
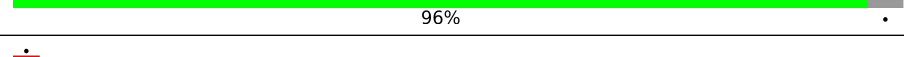
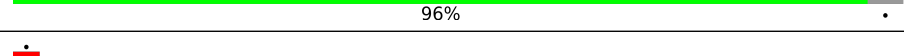
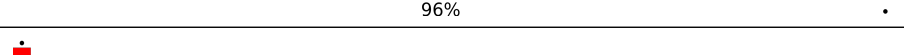
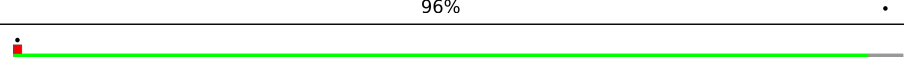
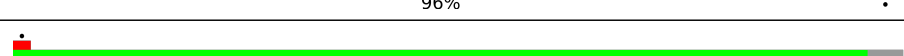
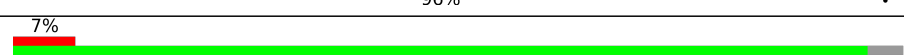
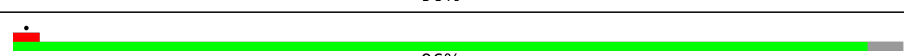
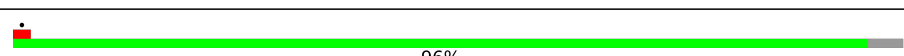
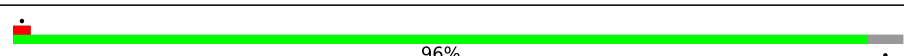
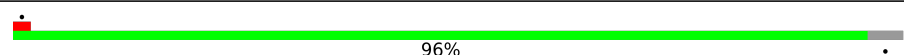
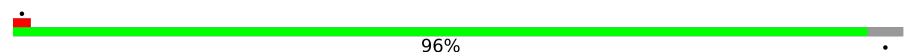
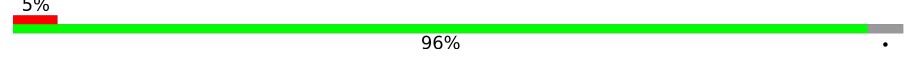
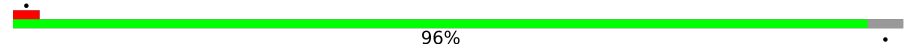
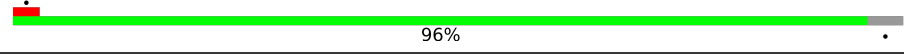
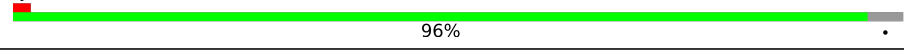
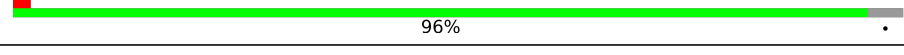
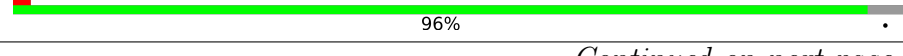
Continued from previous page...

Mol	Chain	Length	Quality of chain
43	QT	445	 96%
43	QV	445	 96%
43	QX	445	 96%
43	RB	445	 96%
43	RD	445	 96%
43	RF	445	 96%
43	RH	445	 96%
43	RJ	445	 96%
43	RL	445	 96%
43	RN	445	 96%
43	RP	445	 96%
43	RR	445	 96%
43	RT	445	 96%
43	RV	445	 96%
43	RX	445	 96%
43	SB	445	 96%
43	SD	445	 96%
43	SF	445	 96%
43	SH	445	 96%
43	SJ	445	 96%
43	SL	445	 96%
43	SN	445	 96%
43	SP	445	 96%
43	SR	445	 96%
43	ST	445	 96%

Continued on next page...

Continued from previous page...

Mol	Chain	Length	Quality of chain
43	SV	445	5% 96%
43	SX	445	96%
43	TB	445	96%
43	TD	445	96%
43	TF	445	96%
43	TH	445	96%
43	TJ	445	7% 96%
43	TL	445	7% 96%
43	TN	445	5% 96%
43	TP	445	96%
43	TR	445	96%
43	TT	445	96%
43	TV	445	7% 96%
43	TX	445	5% 96%
43	TZ	445	96%
43	UB	445	96%
43	UD	445	96%
43	UF	445	96%
43	UH	445	96%
43	UJ	445	96%
43	UL	445	96%
43	UN	445	96%
43	UP	445	96%
43	UR	445	96%
43	UT	445	96%

Continued on next page...

Continued from previous page...

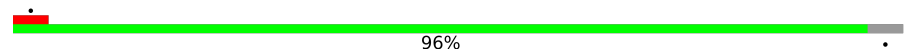
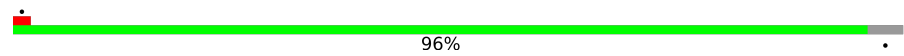
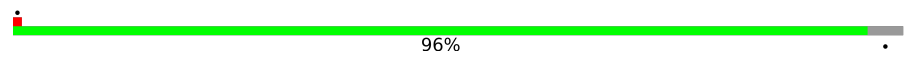
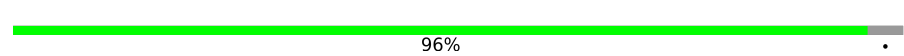
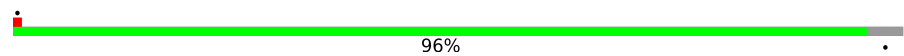
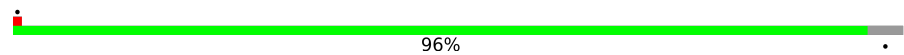
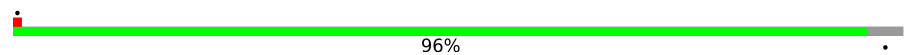
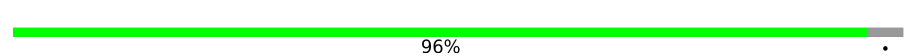
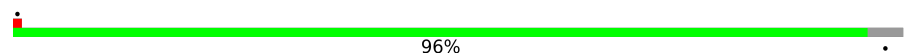
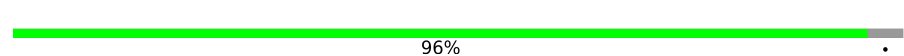
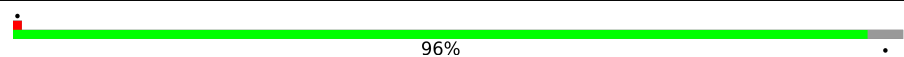
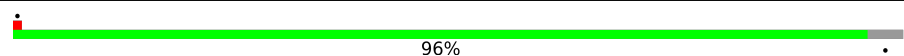
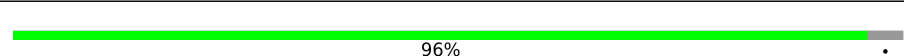
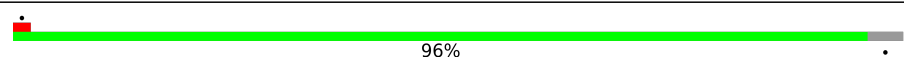
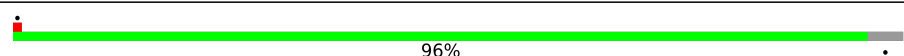
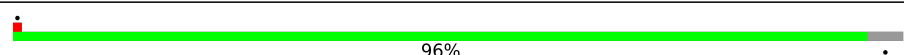
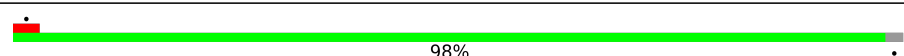
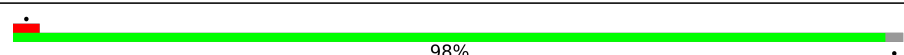
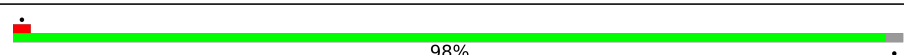
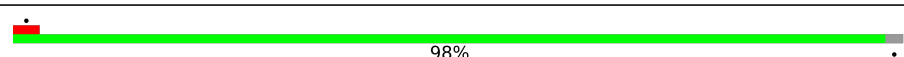
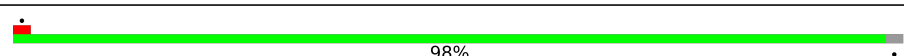
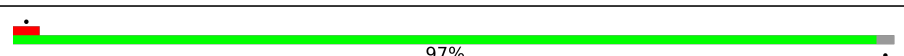
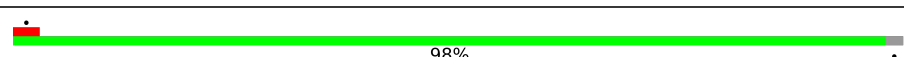
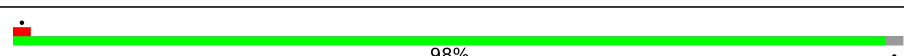
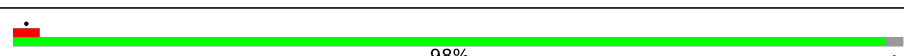
Mol	Chain	Length	Quality of chain
43	UV	445	 96%
43	UX	445	 96%
43	UZ	445	 96%
43	VB	445	 96%
43	VD	445	 96%
43	VF	445	 96%
43	VH	445	 96%
43	VJ	445	 96%
43	VL	445	 96%
43	VN	445	 96%
43	VP	445	 96%
43	VR	445	 96%
43	VT	445	 96%
43	VV	445	 96%
43	VX	445	 96%
43	VZ	445	 96%
43	WB	445	 98%
43	WD	445	 98%
43	WF	445	 98%
43	WH	445	 98%
43	WJ	445	 98%
43	WL	445	 97%
43	WN	445	 98%
43	WP	445	 98%
43	WR	445	 98%

Continued on next page...

Continued from previous page...

Mol	Chain	Length	Quality of chain
43	WT	445	98%
43	WV	445	98%
43	WX	445	98%
44	E	560	13% 30% 70%
44	F	560	10% 39% 61%
44	e	560	13% 39% 61%
44	f	560	8% 38% 62%
45	G	716	9% 64% 36%
45	H	716	14% 65% 35%
45	I	716	9% 65% 35%
45	J	716	15% 66% 34%
45	g	716	32% 65% 35%
45	h	716	20% 66% 34%
45	i	716	17% 65% 35%
45	j	716	17% 66% 34%
46	K	151	13% 21% 79%
46	L	151	7% 23% 77%
46	k	151	21% 21% 79%
46	l	151	9% 25% 75%
47	M	276	15% 100%
47	N	276	32% 93% 7%
47	O	276	44% 100%
47	P	276	26% 95% 5%
47	m	276	29% 100%
47	n	276	49% 95% 5%









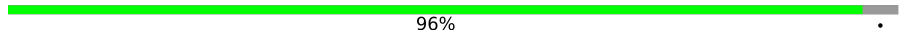
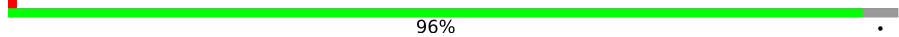
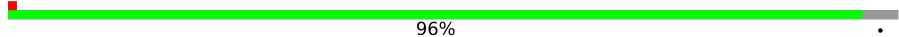
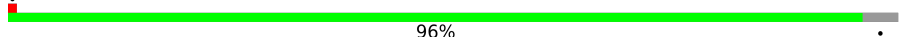
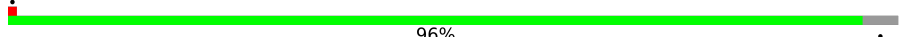
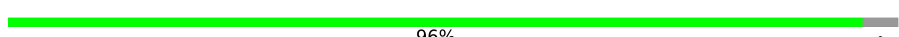
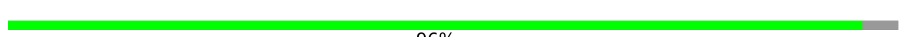

Continued on next page...

Continued from previous page...

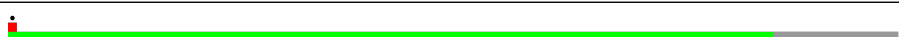
Mol	Chain	Length	Quality of chain
47	o	276	28% 100%
47	p	276	21% 95% 5%
48	Q	230	25% 76% 24%
48	R	230	16% 84%
48	q	230	28% 90% 10%
48	r	230	18% 82%
49	S	311	31% 93% 7%
49	s	311	19% 93% 7%
50	T	348	15% 97% .
50	t	348	27% 93% 7%
51	U	316	27% 94% 6%
51	V	316	53% 94% 6%
51	u	316	37% 94% 6%
51	v	316	33% 94% 6%
52	W	149	51% 95% 5%
53	X	212	35% 91% 9%
53	Y	212	50% 91% 9%
53	x	212	18% 91% 9%
53	y	212	39% 91% 9%
54	XA	193	96% .
54	XB	193	96% .
54	XC	193	96% .
54	XD	193	96% .
54	XE	193	96% .
54	XF	193	96% .

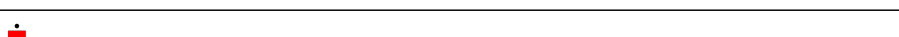
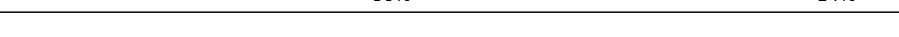
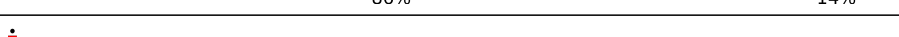
Continued on next page...

Continued from previous page...

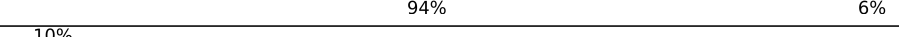
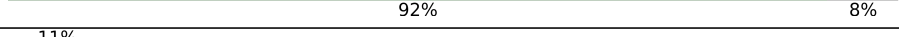
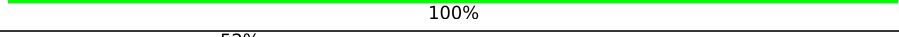
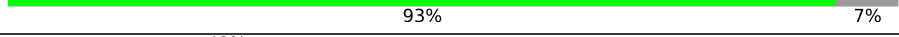
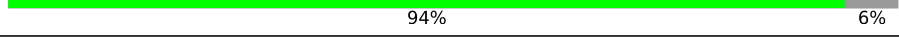
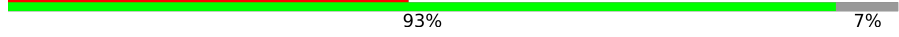
Mol	Chain	Length	Quality of chain
54	XG	193	 96%
54	XH	193	 96%
54	XI	193	 96%
54	XJ	193	 96%
54	XK	193	 96%
54	XL	193	 96%
54	XM	193	 96%
55	YB	257	 86% 14%
55	YC	257	 86% 14%
55	YD	257	 86% 14%
55	YF	257	 86% 14%
55	YG	257	 86% 14%
55	YH	257	 86% 14%
55	YI	257	 86% 14%
55	YJ	257	 86% 14%
55	YK	257	 86% 14%
55	YL	257	 86% 14%
55	YM	257	 86% 14%
56	Z	228	 26% 94% 6%
56	z	228	 10% 92% 8%
57	a0	72	 11% 100%
58	a1	89	 52% 93% 7%
58	a2	89	 49% 94% 6%
58	a3	89	 45% 93% 7%
58	a4	89	 40% 99%

Continued on next page...

Continued from previous page...

Mol	Chain	Length	Quality of chain
58	a5	89	8% 94% 6%
58	a6	89	6% 93% 7%
58	a7	89	24% 96% .
58	a8	89	19% 97% .
58	a9	89	47% 96% .
58	b0	89	35% 100%
58	b1	89	40% 94% ..
58	b2	89	85% 99% .
58	b3	89	52% 98% .
58	b4	89	40% 94% 6%
58	b5	89	47% 94% 6%
58	b6	89	40% 93% 7%
58	b7	89	31% 97% .
58	b8	89	42% 98% .
58	b9	89	37% 100%
58	c0	89	74% 96% .
58	l1	89	9% 100%
58	l2	89	. 100%
58	l3	89	. 100%
58	l4	89	. 100%
58	l5	89	100%
58	l6	89	. 100%
58	n1	89	31% 100%
58	n2	89	9% 100%
58	n3	89	17% 100%

Continued on next page...

Continued from previous page...

Mol	Chain	Length	Quality of chain
58	n4	89	8% 100%
58	n5	89	36% 100%
58	n6	89	9% 100%
58	p1	89	34% 100%
58	p2	89	12% 100%
58	p3	89	12% 100%
58	p4	89	9% 100%
58	p5	89	29% 100%
58	p6	89	11% 100%
58	r1	89	44% 100%
58	r2	89	17% 100%
58	r3	89	35% 100%
58	r4	89	9% 100%
58	r5	89	47% 100%
58	r6	89	19% 100%
59	c1	240	25% 95% 5%
60	c2	791	25% 80% 20%
61	c3	177	8% 25% 75%
61	c4	177	8% 31% 69%
61	c5	177	9% 34% 66%
61	c6	177	7% 34% 66%
62	d0	1237	45% 88% 12%
63	d1	767	20% 68% 32%
64	d2	1149	36% 79% 21%
65	d3	475	54% 88% 12%











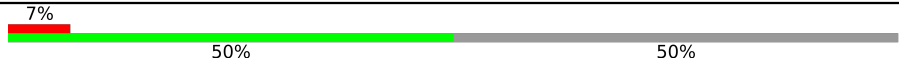

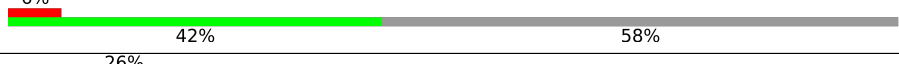

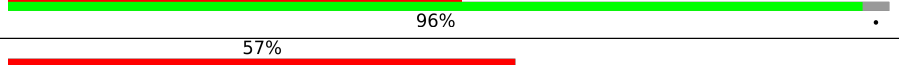
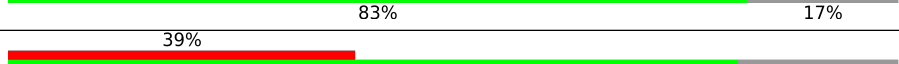
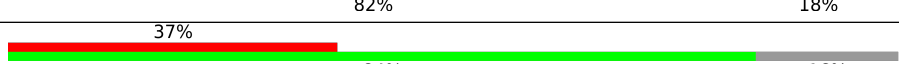
Continued on next page...

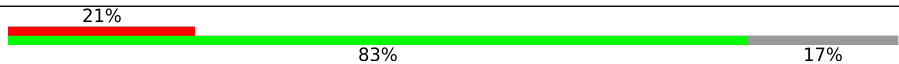
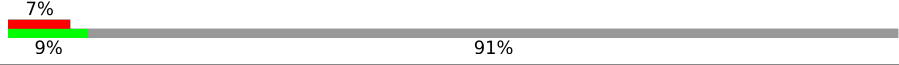
Continued from previous page...

Mol	Chain	Length	Quality of chain
66	d4	365	53% 98%
67	d5	377	24% 100%
67	d6	377	17% 100%
67	d7	377	23% 98%
67	d8	377	66% 100%
67	d9	377	46% 97%
67	f1	377	28% 98%
68	e0	258	52% 81% 19%
68	e1	258	28% 77% 23%
68	e2	258	23% 81% 19%
68	e3	258	52% 77% 23%
68	e4	258	62% 78% 22%
68	e5	258	17% 77% 23%
68	e6	258	19% 77% 23%
68	e7	258	39% 77% 23%
68	e8	258	34% 81% 19%
68	e9	258	47% 77% 23%
69	f2	172	22% 85% 15%
70	g1	3960	49% 99%
71	g2	4024	10% 13% 87%
71	g4	4024	8% 11% 89%
72	g3	4116	6% 14% 86%
73	g5	4158	60% 96%
74	g6	4265	40% 98%
75	h1	941	41% 59%

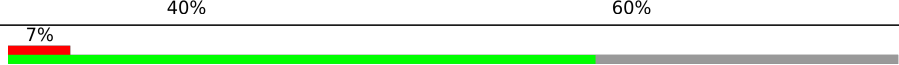
Continued on next page...

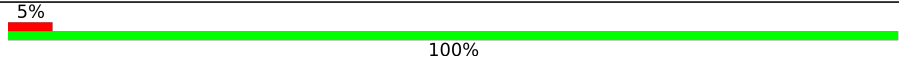
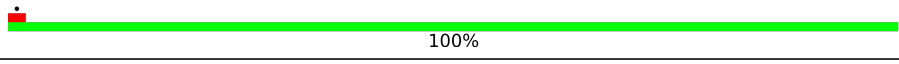
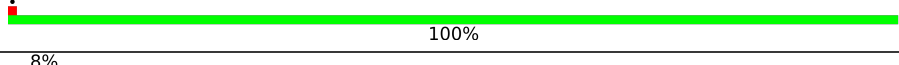
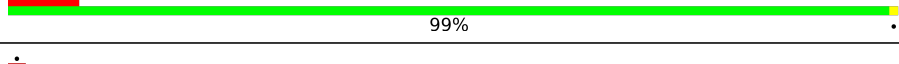
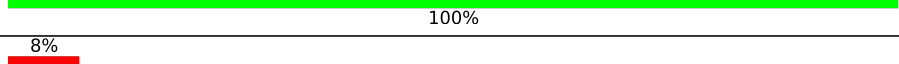
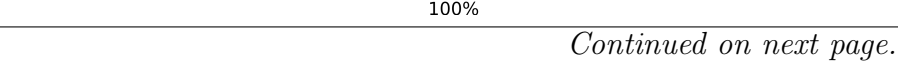
Continued from previous page...

Mol	Chain	Length	Quality of chain
75	h2	941	
76	h3	1142	
76	h4	1142	
77	i1	555	
78	i2	377	
79	i3	233	
80	i4	1250	
80	i5	1250	
81	i6	1665	
81	i8	1665	
82	i7	1854	
82	i9	1854	
83	j1	872	
83	j2	872	
84	j3	308	
85	j4	611	
86	k1	891	
87	k2	848	
88	k3	716	
89	k4	96	
89	m4	96	
89	o4	96	
89	q4	96	
90	k5	96	
90	m5	96	

Continued on next page...

Continued from previous page...

Mol	Chain	Length	Quality of chain
90	o5	96	9% 100%
90	q5	96	18% 100%
91	k8	4589	29% 97%
92	k9	4427	58% 98%
93	l7	142	74% 26%
93	n7	142	56% 80% 20%
93	p7	142	54% 80% 20%
93	r7	142	61% 80% 20%
94	l8	113	90% 10%
94	n8	113	67% 91% 9%
94	p8	113	65% 91% 9%
94	r8	113	70% 80% 20%
95	m0	211	41% 100%
95	q0	211	42% 100%
95	s0	211	37% 100%
95	u0	211	40% 100%
96	m1	699	8% 75% 25%
96	o1	699	8% 75% 25%
96	q1	699	12% 75% 25%
96	s1	699	8% 59% 41%
97	m2	605	15% 87% 13%
97	o2	605	14% 87% 13%
97	q2	605	20% 87% 13%
97	s2	605	6% 66% 34%
98	m3	190	100% 100%





Continued on next page...

Continued from previous page...

Mol	Chain	Length	Quality of chain
98	o3	190	100% 100%
98	q3	190	100% 100%
99	m6	670	25% 52% 48%
99	o6	670	16% 28% 72%
99	q6	670	27% 52% 48%
99	s6	670	24% 52% 48%
99	u6	670	13% 32% 68%
100	m7	1044	21% 57% 43%
100	q7	1044	21% 57% 43%
100	s7	1044	19% 57% 43%
100	u7	1044	21% 57% 43%
101	m8	595	34% 70% 30%
101	o8	595	24% 40% 60%
101	q8	595	38% 70% 30%
101	s8	595	33% 70% 30%
101	u8	595	13% 39% 61%
102	m9	672	5% 30% 70%
102	q9	672	5% 30% 70%
102	s9	672	5% 30% 70%
102	u9	672	5% 30% 70%
103	n0	4624	51% 99%
103	p0	4624	51% 99%
103	r0	4624	55% 99%
103	t0	4624	18% 82%
104	n9	4486	75% 100%

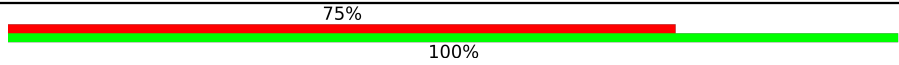
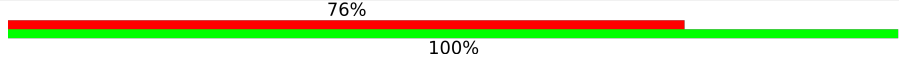
Continued on next page...

Continued from previous page...

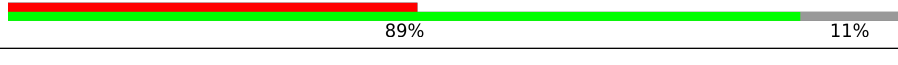
Mol	Chain	Length	Quality of chain
104	p9	4486	 <p>75% 100%</p>
104	r9	4486	 <p>76% 100%</p>
104	t9	4486	 <p>16% 84%</p>
105	v1	330	 <p>40% 60%</p>
105	v2	330	 <p>40% 60%</p>
105	v3	330	 <p>40% 60%</p>
106	w	464	 <p>46% 89% 11%</p>

2 Entry composition [i](#)

There are 109 unique types of molecules in this entry. The entry contains 3163608 atoms, of which 0 are hydrogens and 0 are deuteriums.

In the tables below, the AltConf column contains the number of residues with at least one atom in alternate conformation and the Trace column contains the number of residues modelled with at most 2 atoms.

- Molecule 1 is a protein called Dynein regulatory complex subunit 4.

Mol	Chain	Residues	Atoms					AltConf	Trace
			Total	C	N	O	S		
1	0	478	Total	C	N	O	S	0	0
			3952	2457	723	755	17		
1	4	459	Total	C	N	O	S	0	0
			3831	2381	702	731	17		

- Molecule 2 is a protein called Dynein regulatory complex protein 1.

Mol	Chain	Residues	Atoms					AltConf	Trace
			Total	C	N	O	S		
2	1	540	Total	C	N	O	S	0	0
			4537	2883	782	856	16		

- Molecule 3 is a protein called Dynein regulatory complex protein 10.

Mol	Chain	Residues	Atoms					AltConf	Trace
			Total	C	N	O	S		
3	10	346	Total	C	N	O	S	0	0
			2851	1772	519	546	14		

- Molecule 4 is a protein called Dynein regulatory complex protein 11.

Mol	Chain	Residues	Atoms					AltConf	Trace
			Total	C	N	O	S		
4	11	616	Total	C	N	O	S	0	0
			4998	3226	858	890	24		

- Molecule 5 is a protein called Dynein regulatory complex protein 8.

Mol	Chain	Residues	Atoms					AltConf	Trace
			Total	C	N	O	S		
5	12	118	Total	C	N	O	S	0	0
			961	610	161	186	4		
5	13	138	Total	C	N	O	S	0	0
			1128	717	190	216	5		
5	14	140	Total	C	N	O	S	0	0
			1143	725	195	218	5		

Continued on next page...

Continued from previous page...

Mol	Chain	Residues	Atoms					AltConf	Trace
			Total	C	N	O	S		
5	8	124	1009	644	167	194	4	0	0

- Molecule 6 is a protein called EF-hand domain-containing family member B.

Mol	Chain	Residues	Atoms					AltConf	Trace
			Total	C	N	O	S		
6	1A	523	4234	2686	744	789	15	0	0
6	1B	554	4483	2850	787	830	16	0	0
6	1C	90	729	477	129	121	2	0	0

- Molecule 7 is a protein called Cilia- and flagella-associated protein 45.

Mol	Chain	Residues	Atoms					AltConf	Trace
			Total	C	N	O	S		
7	1D	46	385	243	67	74	1	0	0
7	1E	382	3250	1975	624	632	19	0	0
7	1F	452	3849	2336	749	744	20	0	0
7	1G	121	1034	626	212	195	1	0	0
7	1H	176	1491	914	283	284	10	0	0
7	1I	456	3890	2362	756	751	21	0	0
7	1J	332	2861	1723	568	557	13	0	0

- Molecule 8 is a protein called Cilia- and flagella-associated protein 52.

Mol	Chain	Residues	Atoms					AltConf	Trace
			Total	C	N	O	S		
8	1L	610	4717	2978	827	882	30	0	0
8	1M	610	4717	2978	827	882	30	0	0
8	1N	610	4717	2978	827	882	30	0	0
8	1O	610	4717	2978	827	882	30	0	0

Continued on next page...

Continued from previous page...

Mol	Chain	Residues	Atoms					AltConf	Trace
8	1P	610	Total	C	N	O	S	0	0
			4717	2978	827	882	30		
8	1Q	610	Total	C	N	O	S	0	0
			4717	2978	827	882	30		

- Molecule 9 is a protein called Cilia- and flagella-associated protein 53.

Mol	Chain	Residues	Atoms					AltConf	Trace
9	1R	186	Total	C	N	O	S	0	0
			1587	979	297	304	7		
9	1S	463	Total	C	N	O	S	0	0
			3926	2403	744	761	18		
9	1T	330	Total	C	N	O	S	0	0
			2794	1703	531	546	14		

- Molecule 10 is a protein called Cilia- and flagella-associated protein 95.

Mol	Chain	Residues	Atoms					AltConf	Trace
10	1V	146	Total	C	N	O	S	0	0
			1197	757	206	230	4		
10	1W	146	Total	C	N	O	S	0	0
			1197	757	206	230	4		

- Molecule 11 is a protein called Cilia- and flagella-associated protein 107.

Mol	Chain	Residues	Atoms					AltConf	Trace
11	1Y	174	Total	C	N	O	S	0	0
			1470	945	263	259	3		
11	1Z	173	Total	C	N	O	S	0	0
			1463	940	262	258	3		

There are 2 discrepancies between the modelled and reference sequences:

Chain	Residue	Modelled	Actual	Comment	Reference
1Y	191	PHE	LEU	conflict	UNP Q8N1D5
1Z	191	PHE	LEU	conflict	UNP Q8N1D5

- Molecule 12 is a protein called Dynein regulatory complex subunit 2.

Mol	Chain	Residues	Atoms					AltConf	Trace
12	2	464	Total	C	N	O	S	0	0
			3869	2435	679	740	15		

- Molecule 13 is a protein called Protein Flattop.

Mol	Chain	Residues	Atoms					AltConf	Trace
13	2A	116	Total	C	N	O	S	0	0
			900	572	158	167	3		
13	2B	116	Total	C	N	O	S	0	0
			900	572	158	167	3		
13	2C	116	Total	C	N	O	S	0	0
			900	572	158	167	3		
13	2D	116	Total	C	N	O	S	0	0
			900	572	158	167	3		
13	2E	116	Total	C	N	O	S	0	0
			900	572	158	167	3		
13	2F	116	Total	C	N	O	S	0	0
			900	572	158	167	3		
13	2G	79	Total	C	N	O	S	0	0
			600	383	109	105	3		

- Molecule 14 is a protein called Cilia- and flagella-associated protein 141.

Mol	Chain	Residues	Atoms					AltConf	Trace
14	2I	50	Total	C	N	O	S	0	0
			423	269	75	76	3		
14	2J	50	Total	C	N	O	S	0	0
			423	269	75	76	3		

- Molecule 15 is a protein called Cilia- and flagella-associated protein 161.

Mol	Chain	Residues	Atoms					AltConf	Trace
15	2L	277	Total	C	N	O	S	0	0
			2227	1403	397	415	12		
15	2M	277	Total	C	N	O	S	0	0
			2227	1403	397	415	12		
15	2N	277	Total	C	N	O	S	0	0
			2227	1403	397	415	12		
15	2O	277	Total	C	N	O	S	0	0
			2227	1403	397	415	12		

- Molecule 16 is a protein called Cilia- and flagella- associated protein 210.

Mol	Chain	Residues	Atoms					AltConf	Trace
16	2Q	289	Total	C	N	O	S	0	0
			2505	1552	480	463	10		
16	2R	506	Total	C	N	O	S	0	0
			4289	2667	796	810	16		

Continued on next page...

Continued from previous page...

Mol	Chain	Residues	Atoms					AltConf	Trace
			Total	C	N	O	S		
16	2S	265	2205	1373	400	423	9	0	0

- Molecule 17 is a protein called Cilia- and flagella-associated protein 276.

Mol	Chain	Residues	Atoms					AltConf	Trace
			Total	C	N	O	S		
17	2U	112	906	568	166	171	1	0	0
17	2V	112	906	568	166	171	1	0	0
17	2W	112	906	568	166	171	1	0	0
17	2X	112	906	568	166	171	1	0	0
17	2Y	112	906	568	166	171	1	0	0
17	2Z	112	906	568	166	171	1	0	0

- Molecule 18 is a protein called Dynein regulatory complex subunit 3.

Mol	Chain	Residues	Atoms					AltConf	Trace
			Total	C	N	O	S		
18	3	516	4225	2648	719	833	25	0	0

- Molecule 19 is a protein called EF-hand domain-containing protein 1.

Mol	Chain	Residues	Atoms					AltConf	Trace
			Total	C	N	O	S		
19	3A	485	3992	2576	667	735	14	0	0
19	3B	485	3992	2576	667	735	14	0	0
19	3C	484	3984	2570	666	734	14	0	0
19	3D	485	3992	2576	667	735	14	0	0
19	3E	485	3992	2576	667	735	14	0	0
19	3F	484	3984	2570	666	734	14	0	0

- Molecule 20 is a protein called EF-hand domain-containing family member C2.

Mol	Chain	Residues	Atoms					AltConf	Trace
			Total	C	N	O	S		
20	3G	613	Total 5053	C 3263	N 841	O 925	S 24	0	0
20	3H	701	Total 5797	C 3742	N 964	O 1063	S 28	0	0
20	3I	702	Total 5808	C 3748	N 968	O 1064	S 28	0	0
20	3J	701	Total 5797	C 3742	N 964	O 1063	S 28	0	0
20	3K	701	Total 5797	C 3742	N 964	O 1063	S 28	0	0
20	3L	702	Total 5808	C 3748	N 968	O 1064	S 28	0	0
20	3M	687	Total 5692	C 3675	N 944	O 1045	S 28	0	0

- Molecule 21 is a protein called Enkurin.

Mol	Chain	Residues	Atoms					AltConf	Trace
			Total	C	N	O	S		
21	3O	159	Total 1304	C 829	N 227	O 243	S 5	0	0
21	3P	248	Total 2010	C 1283	N 348	O 370	S 9	0	0
21	3Q	250	Total 2023	C 1290	N 350	O 373	S 10	0	0
21	3R	250	Total 2023	C 1290	N 350	O 373	S 10	0	0
21	3S	248	Total 2010	C 1283	N 348	O 370	S 9	0	0
21	3T	250	Total 2023	C 1290	N 350	O 373	S 10	0	0
21	3U	250	Total 2023	C 1290	N 350	O 373	S 10	0	0

- Molecule 22 is a protein called Meiosis-specific nuclear structural protein 1.

Mol	Chain	Residues	Atoms					AltConf	Trace
			Total	C	N	O	S		
22	3W	392	Total 3353	C 2065	N 611	O 656	S 21	0	0
22	3X	480	Total 4115	C 2547	N 753	O 793	S 22	0	0
22	3Y	143	Total 1225	C 770	N 223	O 227	S 5	0	0

- Molecule 23 is a protein called Protein FAM166B.

Mol	Chain	Residues	Atoms					AltConf	Trace
23	4A	80	Total	C	N	O	S	0	0
			619	405	108	103	3		
23	4B	145	Total	C	N	O	S	0	0
			1080	698	187	189	6		
23	4C	145	Total	C	N	O	S	0	0
			1080	698	187	189	6		
23	4D	145	Total	C	N	O	S	0	0
			1080	698	187	189	6		
23	4E	146	Total	C	N	O	S	0	0
			1085	701	188	190	6		
23	4F	145	Total	C	N	O	S	0	0
			1080	698	187	189	6		
23	4G	146	Total	C	N	O	S	0	0
			1085	701	188	190	6		
23	4H	145	Total	C	N	O	S	0	0
			1080	698	187	189	6		
23	4I	145	Total	C	N	O	S	0	0
			1080	698	187	189	6		
23	4J	145	Total	C	N	O	S	0	0
			1080	698	187	189	6		
23	4K	146	Total	C	N	O	S	0	0
			1085	701	188	190	6		
23	4L	145	Total	C	N	O	S	0	0
			1080	698	187	189	6		
23	4M	146	Total	C	N	O	S	0	0
			1085	701	188	190	6		

- Molecule 24 is a protein called Nucleoside diphosphate kinase 7.

Mol	Chain	Residues	Atoms					AltConf	Trace
24	4O	371	Total	C	N	O	S	0	0
			2943	1873	506	543	21		
24	4P	371	Total	C	N	O	S	0	0
			2943	1873	506	543	21		
24	4Q	371	Total	C	N	O	S	0	0
			2943	1873	506	543	21		
24	4R	371	Total	C	N	O	S	0	0
			2943	1873	506	543	21		

- Molecule 25 is a protein called Piercer of microtubule wall 1 protein.

Mol	Chain	Residues	Atoms					AltConf	Trace
25	4S	113	Total	C	N	O	S	0	0
			905	566	165	169	5		

Continued on next page...

Continued from previous page...

Mol	Chain	Residues	Atoms					AltConf	Trace
			Total	C	N	O	S		
25	4T	113	905	566	165	169	5	0	0

- Molecule 26 is a protein called Piercer of microtubule wall 2 protein.

Mol	Chain	Residues	Atoms					AltConf	Trace
			Total	C	N	O	S		
26	4U	94	750	478	127	139	6	0	0
26	4V	94	750	478	127	139	6	0	0
26	4W	53	411	267	64	74	6	0	0

- Molecule 27 is a protein called Dynein regulatory complex subunit 5.

Mol	Chain	Residues	Atoms					AltConf	Trace
			Total	C	N	O	S		
27	5	303	2377	1498	427	442	10	0	0

- Molecule 28 is a protein called RIB43A-like with coiled-coils protein 2.

Mol	Chain	Residues	Atoms					AltConf	Trace
			Total	C	N	O	S		
28	5A	268	2218	1353	432	423	10	0	0
28	5B	368	3089	1886	608	584	11	0	0
28	5C	170	1423	871	278	271	3	0	0

- Molecule 29 is a protein called RIB43A-like with coiled-coils protein 1.

Mol	Chain	Residues	Atoms					AltConf	Trace
			Total	C	N	O	S		
29	5D	89	744	447	154	141	2	0	0
29	5E	335	2728	1650	530	533	15	0	0
29	5F	266	2158	1308	413	424	13	0	0

- Molecule 30 is a protein called Sperm-associated antigen 8.

Mol	Chain	Residues	Atoms					AltConf	Trace
30	5H	179	Total	C	N	O	S	0	0
			1459	919	260	271	9		
30	5I	179	Total	C	N	O	S	0	0
			1459	919	260	271	9		
30	5J	63	Total	C	N	O	S	0	0
			511	317	92	98	4		

- Molecule 31 is a protein called Uncharacterized protein CFAP68.

Mol	Chain	Residues	Atoms					AltConf	Trace
31	5L	89	Total	C	N	O	S	0	0
			763	481	135	143	4		
31	5M	89	Total	C	N	O	S	0	0
			763	481	135	143	4		

- Molecule 32 is a protein called Cilia- and flagella-associated protein 77.

Mol	Chain	Residues	Atoms					AltConf	Trace
32	5O	80	Total	C	N	O	S	0	0
			693	442	131	118	2		
32	5P	226	Total	C	N	O	S	0	0
			1849	1169	349	323	8		
32	5Q	224	Total	C	N	O	S	0	0
			1831	1158	345	320	8		
32	5R	226	Total	C	N	O	S	0	0
			1849	1169	349	323	8		
32	5S	226	Total	C	N	O	S	0	0
			1849	1169	349	323	8		
32	5T	224	Total	C	N	O	S	0	0
			1831	1158	345	320	8		
32	5U	226	Total	C	N	O	S	0	0
			1849	1169	349	323	8		
32	5V	66	Total	C	N	O	S	0	0
			522	330	95	94	3		

- Molecule 33 is a protein called Uncharacterized protein CFAP90.

Mol	Chain	Residues	Atoms					AltConf	Trace
33	5X	127	Total	C	N	O	S	0	0
			1045	659	195	190	1		
33	5Y	127	Total	C	N	O	S	0	0
			1045	659	195	190	1		

- Molecule 34 is a protein called Sperm acrosome-associated protein 9.

Mol	Chain	Residues	Atoms					AltConf	Trace
			Total	C	N	O	S		
34	6A	157	Total 1263	C 788	N 225	O 240	S 10	0	0
34	6C	159	Total 1278	C 799	N 227	O 242	S 10	0	0
34	6E	157	Total 1263	C 788	N 225	O 240	S 10	0	0
34	6G	157	Total 1263	C 788	N 225	O 240	S 10	0	0
34	6I	157	Total 1263	C 788	N 225	O 240	S 10	0	0
34	6K	157	Total 1263	C 788	N 225	O 240	S 10	0	0
34	6L	157	Total 1263	C 788	N 225	O 240	S 10	0	0
34	6N	159	Total 1278	C 799	N 227	O 242	S 10	0	0
34	6O	157	Total 1263	C 788	N 225	O 240	S 10	0	0
34	6Q	157	Total 1263	C 788	N 225	O 240	S 10	0	0
34	6R	157	Total 1263	C 788	N 225	O 240	S 10	0	0
34	6T	157	Total 1263	C 788	N 225	O 240	S 10	0	0
34	6V	157	Total 1263	C 788	N 225	O 240	S 10	0	0

- Molecule 35 is a protein called Dynein regulatory complex subunit 7.

Mol	Chain	Residues	Atoms					AltConf	Trace
			Total	C	N	O	S		
35	7	601	Total 4993	C 3174	N 854	O 931	S 34	0	0

- Molecule 36 is a protein called Protein FAM166C.

Mol	Chain	Residues	Atoms					AltConf	Trace
			Total	C	N	O	S		
36	7A	60	Total 462	C 295	N 81	O 84	S 2	0	0
36	7B	102	Total 825	C 526	N 147	O 148	S 4	0	0
36	7C	102	Total 825	C 526	N 147	O 148	S 4	0	0

Continued on next page...

Continued from previous page...

Mol	Chain	Residues	Atoms					AltConf	Trace
36	7D	101	Total	C	N	O	S	0	0
			818	521	146	147	4		
36	7E	102	Total	C	N	O	S	0	0
			825	526	147	148	4		
36	7F	102	Total	C	N	O	S	0	0
			825	526	147	148	4		
36	7G	101	Total	C	N	O	S	0	0
			818	521	146	147	4		

- Molecule 37 is a protein called Cilia- and flagella-associated protein 144.

Mol	Chain	Residues	Atoms					AltConf	Trace
37	7I	111	Total	C	N	O	S	0	0
			945	594	179	170	2		
37	7J	111	Total	C	N	O	S	0	0
			945	594	179	170	2		

- Molecule 38 is a protein called Tektin-1.

Mol	Chain	Residues	Atoms					AltConf	Trace
38	8A	202	Total	C	N	O	S	0	0
			1615	1002	293	311	9		
38	8B	391	Total	C	N	O	S	0	0
			3185	1978	576	619	12		
38	8C	391	Total	C	N	O	S	0	0
			3185	1978	576	619	12		
38	8D	391	Total	C	N	O	S	0	0
			3185	1978	576	619	12		
38	8E	391	Total	C	N	O	S	0	0
			3185	1978	576	619	12		
38	8F	391	Total	C	N	O	S	0	0
			3185	1978	576	619	12		
38	8G	340	Total	C	N	O	S	0	0
			2770	1723	493	544	10		
38	8H	36	Total	C	N	O		0	0
			305	188	63	54			

- Molecule 39 is a protein called Tektin-2.

Mol	Chain	Residues	Atoms					AltConf	Trace
39	8J	58	Total	C	N	O	S	0	0
			498	300	100	97	1		

Continued on next page...

Continued from previous page...

Mol	Chain	Residues	Atoms					AltConf	Trace
39	8K	381	Total	C	N	O	S	0	0
			3088	1891	567	615	15		
39	8L	378	Total	C	N	O	S	0	0
			3063	1877	561	610	15		
39	8M	383	Total	C	N	O	S	0	0
			3109	1907	570	617	15		
39	8N	384	Total	C	N	O	S	0	0
			3117	1911	571	620	15		
39	8O	384	Total	C	N	O	S	0	0
			3117	1911	571	620	15		
39	8P	360	Total	C	N	O	S	0	0
			2916	1789	531	581	15		
39	8Q	23	Total	C	N	O	S	0	0
			192	117	38	36	1		

- Molecule 40 is a protein called Dynein regulatory complex protein 9.

Mol	Chain	Residues	Atoms					AltConf	Trace
40	9	278	Total	C	N	O	S	0	0
			2336	1466	407	451	12		

- Molecule 41 is a protein called Radial spoke head 1 homolog.

Mol	Chain	Residues	Atoms					AltConf	Trace
41	A	210	Total	C	N	O	S	0	0
			1710	1066	308	334	2		
41	B	210	Total	C	N	O	S	0	0
			1710	1066	308	334	2		
41	C	210	Total	C	N	O	S	0	0
			1710	1066	308	334	2		
41	D	210	Total	C	N	O	S	0	0
			1710	1066	308	334	2		
41	a	210	Total	C	N	O	S	0	0
			1710	1066	308	334	2		
41	b	210	Total	C	N	O	S	0	0
			1710	1066	308	334	2		
41	c	210	Total	C	N	O	S	0	0
			1710	1066	308	334	2		
41	d	210	Total	C	N	O	S	0	0
			1710	1066	308	334	2		

- Molecule 42 is a protein called Tubulin alpha-1A chain.

Mol	Chain	Residues	Atoms					AltConf	Trace
42	AZ	439	Total 3429	C 2170	N 583	O 654	S 22	0	0
42	AC	439	Total 3429	C 2170	N 583	O 654	S 22	0	0
42	AE	439	Total 3429	C 2170	N 583	O 654	S 22	0	0
42	AG	439	Total 3429	C 2170	N 583	O 654	S 22	0	0
42	AI	439	Total 3429	C 2170	N 583	O 654	S 22	0	0
42	AK	439	Total 3429	C 2170	N 583	O 654	S 22	0	0
42	AM	439	Total 3429	C 2170	N 583	O 654	S 22	0	0
42	AO	439	Total 3429	C 2170	N 583	O 654	S 22	0	0
42	AQ	439	Total 3429	C 2170	N 583	O 654	S 22	0	0
42	AS	439	Total 3429	C 2170	N 583	O 654	S 22	0	0
42	AU	439	Total 3429	C 2170	N 583	O 654	S 22	0	0
42	AW	439	Total 3429	C 2170	N 583	O 654	S 22	0	0
42	AY	439	Total 3429	C 2170	N 583	O 654	S 22	0	0
42	BA	439	Total 3429	C 2170	N 583	O 654	S 22	0	0
42	BC	439	Total 3429	C 2170	N 583	O 654	S 22	0	0
42	BE	432	Total 3383	C 2143	N 575	O 643	S 22	0	0
42	BG	439	Total 3429	C 2170	N 583	O 654	S 22	0	0
42	BI	432	Total 3383	C 2143	N 575	O 643	S 22	0	0
42	BK	439	Total 3429	C 2170	N 583	O 654	S 22	0	0
42	BM	433	Total 3387	C 2145	N 576	O 644	S 22	0	0
42	BO	439	Total 3429	C 2170	N 583	O 654	S 22	0	0
42	BQ	439	Total 3429	C 2170	N 583	O 654	S 22	0	0

Continued on next page...

Continued from previous page...

Mol	Chain	Residues	Atoms					AltConf	Trace
			Total	C	N	O	S		
42	BS	439	Total 3429	C 2170	N 583	O 654	S 22	0	0
42	BU	439	Total 3429	C 2170	N 583	O 654	S 22	0	0
42	BW	439	Total 3429	C 2170	N 583	O 654	S 22	0	0
42	BY	432	Total 3383	C 2143	N 575	O 643	S 22	0	0
42	CC	439	Total 3429	C 2170	N 583	O 654	S 22	0	0
42	CE	430	Total 3371	C 2137	N 573	O 639	S 22	0	0
42	CG	439	Total 3429	C 2170	N 583	O 654	S 22	0	0
42	CI	431	Total 3377	C 2140	N 574	O 641	S 22	0	0
42	CK	439	Total 3429	C 2170	N 583	O 654	S 22	0	0
42	CM	431	Total 3377	C 2140	N 574	O 641	S 22	0	0
42	CO	439	Total 3429	C 2170	N 583	O 654	S 22	0	0
42	CQ	439	Total 3429	C 2170	N 583	O 654	S 22	0	0
42	CS	439	Total 3429	C 2170	N 583	O 654	S 22	0	0
42	CU	439	Total 3429	C 2170	N 583	O 654	S 22	0	0
42	CW	431	Total 3377	C 2140	N 574	O 641	S 22	0	0
42	CY	439	Total 3429	C 2170	N 583	O 654	S 22	0	0
42	DC	430	Total 3371	C 2137	N 573	O 639	S 22	0	0
42	DE	431	Total 3379	C 2141	N 574	O 642	S 22	0	0
42	DG	430	Total 3371	C 2137	N 573	O 639	S 22	0	0
42	DI	430	Total 3371	C 2137	N 573	O 639	S 22	0	0
42	DK	430	Total 3371	C 2137	N 573	O 639	S 22	0	0

Continued on next page...

Continued from previous page...

Mol	Chain	Residues	Atoms					AltConf	Trace
			Total	C	N	O	S		
42	DM	431	Total 3379	C 2141	N 574	O 642	S 22	0	0
42	DO	431	Total 3379	C 2141	N 574	O 642	S 22	0	0
42	DQ	430	Total 3371	C 2137	N 573	O 639	S 22	0	0
42	DS	431	Total 3379	C 2141	N 574	O 642	S 22	0	0
42	DU	430	Total 3371	C 2137	N 573	O 639	S 22	0	0
42	DW	430	Total 3371	C 2137	N 573	O 639	S 22	0	0
42	DY	430	Total 3371	C 2137	N 573	O 639	S 22	0	0
42	EC	439	Total 3429	C 2170	N 583	O 654	S 22	0	0
42	EE	439	Total 3429	C 2170	N 583	O 654	S 22	0	0
42	EG	438	Total 3423	C 2167	N 582	O 652	S 22	0	0
42	EI	439	Total 3429	C 2170	N 583	O 654	S 22	0	0
42	EK	438	Total 3423	C 2167	N 582	O 652	S 22	0	0
42	EM	438	Total 3423	C 2167	N 582	O 652	S 22	0	0
42	EO	438	Total 3423	C 2167	N 582	O 652	S 22	0	0
42	EQ	439	Total 3429	C 2170	N 583	O 654	S 22	0	0
42	ES	439	Total 3429	C 2170	N 583	O 654	S 22	0	0
42	EU	438	Total 3423	C 2167	N 582	O 652	S 22	0	0
42	EW	439	Total 3429	C 2170	N 583	O 654	S 22	0	0
42	EY	438	Total 3423	C 2167	N 582	O 652	S 22	0	0
42	FC	431	Total 3379	C 2141	N 574	O 642	S 22	0	0
42	FE	428	Total 3357	C 2130	N 571	O 634	S 22	0	0

Continued on next page...

Continued from previous page...

Mol	Chain	Residues	Atoms					AltConf	Trace
			Total	C	N	O	S		
42	FG	430	3371	2137	573	639	22	0	0
42	FI	430	3371	2137	573	639	22	0	0
42	FK	430	3371	2137	573	639	22	0	0
42	FM	430	3371	2137	573	639	22	0	0
42	FO	430	3371	2137	573	639	22	0	0
42	FQ	431	3379	2141	574	642	22	0	0
42	FS	431	3379	2141	574	642	22	0	0
42	FU	430	3371	2137	573	639	22	0	0
42	FW	430	3371	2137	573	639	22	0	0
42	FY	430	3371	2137	573	639	22	0	0
42	GC	431	3379	2141	574	642	22	0	0
42	GE	432	3385	2144	575	644	22	0	0
42	GG	430	3373	2138	573	640	22	0	0
42	GI	431	3379	2141	574	642	22	0	0
42	GK	433	3396	2151	577	646	22	0	0
42	GM	430	3373	2138	573	640	22	0	0
42	GO	430	3373	2138	573	640	22	0	0
42	GQ	430	3371	2137	573	639	22	0	0
42	GS	431	3379	2141	574	642	22	0	0
42	GU	432	3383	2143	575	643	22	0	0
42	GW	439	3429	2170	583	654	22	0	0

Continued on next page...

Continued from previous page...

Mol	Chain	Residues	Atoms					AltConf	Trace
			Total	C	N	O	S		
42	GY	428	Total 3357	C 2130	N 571	O 634	S 22	0	0
42	HA	430	Total 3371	C 2137	N 573	O 639	S 22	0	0
42	HC	431	Total 3379	C 2141	N 574	O 642	S 22	0	0
42	HE	431	Total 3379	C 2141	N 574	O 642	S 22	0	0
42	HG	430	Total 3371	C 2137	N 573	O 639	S 22	0	0
42	HI	430	Total 3371	C 2137	N 573	O 639	S 22	0	0
42	HK	430	Total 3371	C 2137	N 573	O 639	S 22	0	0
42	HM	430	Total 3371	C 2137	N 573	O 639	S 22	0	0
42	HO	430	Total 3371	C 2137	N 573	O 639	S 22	0	0
42	HQ	431	Total 3379	C 2141	N 574	O 642	S 22	0	0
42	HS	431	Total 3379	C 2141	N 574	O 642	S 22	0	0
42	HU	430	Total 3371	C 2137	N 573	O 639	S 22	0	0
42	HW	430	Total 3371	C 2137	N 573	O 639	S 22	0	0
42	HY	430	Total 3371	C 2137	N 573	O 639	S 22	0	0
42	IA	439	Total 3429	C 2170	N 583	O 654	S 22	0	0
42	IC	432	Total 3385	C 2144	N 575	O 644	S 22	0	0
42	IE	439	Total 3429	C 2170	N 583	O 654	S 22	0	0
42	IG	438	Total 3423	C 2167	N 582	O 652	S 22	0	0
42	II	432	Total 3385	C 2144	N 575	O 644	S 22	0	0
42	IK	430	Total 3373	C 2138	N 573	O 640	S 22	0	0
42	IM	438	Total 3423	C 2167	N 582	O 652	S 22	0	0

Continued on next page...

Continued from previous page...

Mol	Chain	Residues	Atoms					AltConf	Trace
			Total	C	N	O	S		
42	IO	431	Total 3379	C 2141	N 574	O 642	S 22	0	0
42	IQ	439	Total 3429	C 2170	N 583	O 654	S 22	0	0
42	IS	432	Total 3385	C 2144	N 575	O 644	S 22	0	0
42	IU	432	Total 3387	C 2145	N 575	O 645	S 22	0	0
42	IW	431	Total 3379	C 2141	N 574	O 642	S 22	0	0
42	IY	438	Total 3423	C 2167	N 582	O 652	S 22	0	0
42	JC	430	Total 3371	C 2137	N 573	O 639	S 22	0	0
42	JE	431	Total 3379	C 2141	N 574	O 642	S 22	0	0
42	JG	433	Total 3396	C 2151	N 577	O 646	S 22	0	0
42	JI	431	Total 3379	C 2141	N 574	O 642	S 22	0	0
42	JK	429	Total 3365	C 2134	N 572	O 637	S 22	0	0
42	JM	429	Total 3365	C 2134	N 572	O 637	S 22	0	0
42	JO	430	Total 3373	C 2138	N 573	O 640	S 22	0	0
42	JQ	430	Total 3371	C 2137	N 573	O 639	S 22	0	0
42	JS	431	Total 3379	C 2141	N 574	O 642	S 22	0	0
42	JU	429	Total 3365	C 2134	N 572	O 637	S 22	0	0
42	JW	431	Total 3377	C 2140	N 574	O 641	S 22	0	0
42	JY	430	Total 3371	C 2137	N 573	O 639	S 22	0	0
42	KC	431	Total 3379	C 2141	N 574	O 642	S 22	0	0
42	KE	431	Total 3379	C 2141	N 574	O 642	S 22	0	0
42	KG	430	Total 3371	C 2137	N 573	O 639	S 22	0	0

Continued on next page...

Continued from previous page...

Mol	Chain	Residues	Atoms					AltConf	Trace
			Total	C	N	O	S		
42	KI	430	3371	2137	573	639	22	0	0
42	KK	430	3371	2137	573	639	22	0	0
42	KM	430	3371	2137	573	639	22	0	0
42	KO	430	3371	2137	573	639	22	0	0
42	KQ	431	3379	2141	574	642	22	0	0
42	KS	430	3371	2137	573	639	22	0	0
42	KU	435	3409	2160	579	648	22	0	0
42	KW	430	3371	2137	573	639	22	0	0
42	KY	430	3371	2137	573	639	22	0	0
42	LC	433	3389	2146	576	645	22	0	0
42	LE	433	3389	2146	576	645	22	0	0
42	LG	432	3383	2143	575	643	22	0	0
42	LI	431	3379	2141	574	642	22	0	0
42	LK	431	3379	2141	574	642	22	0	0
42	LM	438	3423	2167	582	652	22	0	0
42	LO	438	3423	2167	582	652	22	0	0
42	LQ	438	3423	2167	582	652	22	0	0
42	LS	439	3429	2170	583	654	22	0	0
42	LU	432	3385	2144	575	644	22	0	0
42	LW	434	3397	2150	577	648	22	0	0
42	LY	439	3429	2170	583	654	22	0	0

Continued on next page...

Continued from previous page...

Mol	Chain	Residues	Atoms					AltConf	Trace
			Total	C	N	O	S		
42	MA	430	Total 3371	C 2137	N 573	O 639	S 22	0	0
42	MC	431	Total 3379	C 2141	N 574	O 642	S 22	0	0
42	ME	431	Total 3379	C 2141	N 574	O 642	S 22	0	0
42	MG	430	Total 3371	C 2137	N 573	O 639	S 22	0	0
42	MI	430	Total 3371	C 2137	N 573	O 639	S 22	0	0
42	MK	430	Total 3371	C 2137	N 573	O 639	S 22	0	0
42	MM	430	Total 3371	C 2137	N 573	O 639	S 22	0	0
42	MO	430	Total 3371	C 2137	N 573	O 639	S 22	0	0
42	MQ	431	Total 3379	C 2141	N 574	O 642	S 22	0	0
42	MS	431	Total 3379	C 2141	N 574	O 642	S 22	0	0
42	MU	430	Total 3371	C 2137	N 573	O 639	S 22	0	0
42	MW	430	Total 3371	C 2137	N 573	O 639	S 22	0	0
42	MY	430	Total 3371	C 2137	N 573	O 639	S 22	0	0
42	NA	431	Total 3379	C 2141	N 574	O 642	S 22	0	0
42	NC	439	Total 3429	C 2170	N 583	O 654	S 22	0	0
42	NE	434	Total 3397	C 2150	N 577	O 648	S 22	0	0
42	NG	430	Total 3373	C 2138	N 573	O 640	S 22	0	0
42	NI	432	Total 3385	C 2144	N 575	O 644	S 22	0	0
42	NK	438	Total 3423	C 2167	N 582	O 652	S 22	0	0
42	NM	431	Total 3379	C 2141	N 574	O 642	S 22	0	0
42	NO	432	Total 3387	C 2145	N 575	O 645	S 22	0	0

Continued on next page...

Continued from previous page...

Mol	Chain	Residues	Atoms					AltConf	Trace
			Total	C	N	O	S		
42	NQ	432	Total 3385	C 2144	N 575	O 644	S 22	0	0
42	NS	435	Total 3406	C 2156	N 579	O 649	S 22	0	0
42	NU	433	Total 3396	C 2151	N 577	O 646	S 22	0	0
42	NW	433	Total 3393	C 2148	N 576	O 647	S 22	0	0
42	OA	431	Total 3379	C 2141	N 574	O 642	S 22	0	0
42	OC	434	Total 3402	C 2154	N 578	O 648	S 22	0	0
42	OE	433	Total 3393	C 2148	N 576	O 647	S 22	0	0
42	OG	432	Total 3383	C 2143	N 575	O 643	S 22	0	0
42	OI	434	Total 3402	C 2154	N 578	O 648	S 22	0	0
42	OK	438	Total 3423	C 2167	N 582	O 652	S 22	0	0
42	OM	438	Total 3423	C 2167	N 582	O 652	S 22	0	0
42	OO	432	Total 3387	C 2145	N 575	O 645	S 22	0	0
42	OQ	433	Total 3393	C 2148	N 576	O 647	S 22	0	0
42	OS	432	Total 3385	C 2144	N 575	O 644	S 22	0	0
42	OU	433	Total 3396	C 2151	N 577	O 646	S 22	0	0
42	OW	435	Total 3406	C 2156	N 579	O 649	S 22	0	0
42	OY	432	Total 3387	C 2145	N 575	O 645	S 22	0	0
42	PA	431	Total 3379	C 2141	N 574	O 642	S 22	0	0
42	PC	431	Total 3379	C 2141	N 574	O 642	S 22	0	0
42	PE	431	Total 3379	C 2141	N 574	O 642	S 22	0	0
42	PG	430	Total 3371	C 2137	N 573	O 639	S 22	0	0

Continued on next page...

Continued from previous page...

Mol	Chain	Residues	Atoms					AltConf	Trace
			Total	C	N	O	S		
42	PI	430	Total 3371	C 2137	N 573	O 639	S 22	0	0
42	PK	430	Total 3371	C 2137	N 573	O 639	S 22	0	0
42	PM	430	Total 3371	C 2137	N 573	O 639	S 22	0	0
42	PO	430	Total 3371	C 2137	N 573	O 639	S 22	0	0
42	PQ	431	Total 3379	C 2141	N 574	O 642	S 22	0	0
42	PS	431	Total 3379	C 2141	N 574	O 642	S 22	0	0
42	PU	430	Total 3371	C 2137	N 573	O 639	S 22	0	0
42	PW	430	Total 3371	C 2137	N 573	O 639	S 22	0	0
42	PY	430	Total 3371	C 2137	N 573	O 639	S 22	0	0
42	QA	431	Total 3379	C 2141	N 574	O 642	S 22	0	0
42	QC	432	Total 3385	C 2144	N 575	O 644	S 22	0	0
42	QE	439	Total 3429	C 2170	N 583	O 654	S 22	0	0
42	QG	430	Total 3373	C 2138	N 573	O 640	S 22	0	0
42	QI	431	Total 3379	C 2141	N 574	O 642	S 22	0	0
42	QK	438	Total 3423	C 2167	N 582	O 652	S 22	0	0
42	QM	435	Total 3407	C 2157	N 579	O 649	S 22	0	0
42	QO	434	Total 3400	C 2153	N 578	O 647	S 22	0	0
42	QQ	432	Total 3385	C 2144	N 575	O 644	S 22	0	0
42	QS	431	Total 3379	C 2141	N 574	O 642	S 22	0	0
42	QU	429	Total 3365	C 2134	N 572	O 637	S 22	0	0
42	QW	431	Total 3379	C 2141	N 574	O 642	S 22	0	0

Continued on next page...

Continued from previous page...

Mol	Chain	Residues	Atoms					AltConf	Trace
42	QY	432	Total 3387	C 2145	N 575	O 645	S 22	0	0
42	RA	431	Total 3379	C 2141	N 574	O 642	S 22	0	0
42	RC	431	Total 3379	C 2141	N 574	O 642	S 22	0	0
42	RE	431	Total 3379	C 2141	N 574	O 642	S 22	0	0
42	RG	430	Total 3371	C 2137	N 573	O 639	S 22	0	0
42	RI	430	Total 3371	C 2137	N 573	O 639	S 22	0	0
42	RK	430	Total 3371	C 2137	N 573	O 639	S 22	0	0
42	RM	430	Total 3371	C 2137	N 573	O 639	S 22	0	0
42	RO	430	Total 3371	C 2137	N 573	O 639	S 22	0	0
42	RQ	431	Total 3379	C 2141	N 574	O 642	S 22	0	0
42	RS	431	Total 3379	C 2141	N 574	O 642	S 22	0	0
42	RU	430	Total 3371	C 2137	N 573	O 639	S 22	0	0
42	RW	430	Total 3371	C 2137	N 573	O 639	S 22	0	0
42	RY	430	Total 3371	C 2137	N 573	O 639	S 22	0	0
42	SC	434	Total 3402	C 2154	N 578	O 648	S 22	0	0
42	SE	432	Total 3385	C 2144	N 575	O 644	S 22	0	0
42	SG	438	Total 3423	C 2167	N 582	O 652	S 22	0	0
42	SI	434	Total 3402	C 2154	N 578	O 648	S 22	0	0
42	SK	438	Total 3423	C 2167	N 582	O 652	S 22	0	0
42	SM	438	Total 3423	C 2167	N 582	O 652	S 22	0	0
42	SO	430	Total 3373	C 2138	N 573	O 640	S 22	0	0

Continued on next page...

Continued from previous page...

Mol	Chain	Residues	Atoms					AltConf	Trace
			Total	C	N	O	S		
42	SQ	431	Total 3379	C 2141	N 574	O 642	S 22	0	0
42	SS	439	Total 3429	C 2170	N 583	O 654	S 22	0	0
42	SU	432	Total 3387	C 2145	N 575	O 645	S 22	0	0
42	SW	439	Total 3429	C 2170	N 583	O 654	S 22	0	0
42	SY	433	Total 3391	C 2147	N 576	O 646	S 22	0	0
42	TC	431	Total 3379	C 2141	N 574	O 642	S 22	0	0
42	TE	431	Total 3379	C 2141	N 574	O 642	S 22	0	0
42	TG	430	Total 3371	C 2137	N 573	O 639	S 22	0	0
42	TI	430	Total 3371	C 2137	N 573	O 639	S 22	0	0
42	TK	430	Total 3371	C 2137	N 573	O 639	S 22	0	0
42	TM	430	Total 3371	C 2137	N 573	O 639	S 22	0	0
42	TO	430	Total 3371	C 2137	N 573	O 639	S 22	0	0
42	TQ	431	Total 3379	C 2141	N 574	O 642	S 22	0	0
42	TS	431	Total 3379	C 2141	N 574	O 642	S 22	0	0
42	TU	430	Total 3371	C 2137	N 573	O 639	S 22	0	0
42	TW	430	Total 3371	C 2137	N 573	O 639	S 22	0	0
42	TY	430	Total 3371	C 2137	N 573	O 639	S 22	0	0
42	UC	434	Total 3397	C 2150	N 577	O 648	S 22	0	0
42	UE	431	Total 3379	C 2141	N 574	O 642	S 22	0	0
42	UG	431	Total 3377	C 2140	N 574	O 641	S 22	0	0
42	UI	431	Total 3379	C 2141	N 574	O 642	S 22	0	0

Continued on next page...

Continued from previous page...

Mol	Chain	Residues	Atoms					AltConf	Trace
			Total	C	N	O	S		
42	UK	431	Total 3379	C 2141	N 574	O 642	S 22	0	0
42	UM	430	Total 3373	C 2138	N 573	O 640	S 22	0	0
42	UO	431	Total 3379	C 2141	N 574	O 642	S 22	0	0
42	UQ	431	Total 3379	C 2141	N 574	O 642	S 22	0	0
42	US	431	Total 3379	C 2141	N 574	O 642	S 22	0	0
42	UU	432	Total 3383	C 2143	N 575	O 643	S 22	0	0
42	UW	432	Total 3385	C 2144	N 575	O 644	S 22	0	0
42	UY	432	Total 3387	C 2145	N 575	O 645	S 22	0	0
42	VC	431	Total 3379	C 2141	N 574	O 642	S 22	0	0
42	VE	431	Total 3379	C 2141	N 574	O 642	S 22	0	0
42	VG	430	Total 3371	C 2137	N 573	O 639	S 22	0	0
42	VI	430	Total 3371	C 2137	N 573	O 639	S 22	0	0
42	VK	430	Total 3371	C 2137	N 573	O 639	S 22	0	0
42	VM	430	Total 3371	C 2137	N 573	O 639	S 22	0	0
42	VO	430	Total 3371	C 2137	N 573	O 639	S 22	0	0
42	VQ	431	Total 3379	C 2141	N 574	O 642	S 22	0	0
42	VS	431	Total 3379	C 2141	N 574	O 642	S 22	0	0
42	VU	430	Total 3371	C 2137	N 573	O 639	S 22	0	0
42	VW	430	Total 3371	C 2137	N 573	O 639	S 22	0	0
42	VY	430	Total 3371	C 2137	N 573	O 639	S 22	0	0
42	WA	439	Total 3429	C 2170	N 583	O 654	S 22	0	0

Continued on next page...

Continued from previous page...

Mol	Chain	Residues	Atoms					AltConf	Trace
			Total	C	N	O	S		
42	WC	432	Total 3385	C 2144	N 575	O 644	S 22	0	0
42	WE	439	Total 3429	C 2170	N 583	O 654	S 22	0	0
42	WG	432	Total 3383	C 2143	N 575	O 643	S 22	0	0
42	WI	439	Total 3429	C 2170	N 583	O 654	S 22	0	0
42	WK	439	Total 3429	C 2170	N 583	O 654	S 22	0	0
42	WM	439	Total 3429	C 2170	N 583	O 654	S 22	0	0
42	WO	431	Total 3379	C 2141	N 574	O 642	S 22	0	0
42	WQ	439	Total 3429	C 2170	N 583	O 654	S 22	0	0
42	WS	432	Total 3383	C 2143	N 575	O 643	S 22	0	0
42	WU	439	Total 3429	C 2170	N 583	O 654	S 22	0	0
42	WW	439	Total 3429	C 2170	N 583	O 654	S 22	0	0

- Molecule 43 is a protein called Tubulin beta-4B chain.

Mol	Chain	Residues	Atoms					AltConf	Trace
			Total	C	N	O	S		
43	AB	437	Total 3433	C 2155	N 585	O 667	S 26	0	0
43	AD	437	Total 3433	C 2155	N 585	O 667	S 26	0	0
43	AF	437	Total 3433	C 2155	N 585	O 667	S 26	0	0
43	AH	433	Total 3400	C 2134	N 581	O 659	S 26	0	0
43	AJ	437	Total 3433	C 2155	N 585	O 667	S 26	0	0
43	AL	434	Total 3404	C 2136	N 582	O 660	S 26	0	0
43	AN	434	Total 3404	C 2136	N 582	O 660	S 26	0	0
43	AP	437	Total 3433	C 2155	N 585	O 667	S 26	0	0

Continued on next page...

Continued from previous page...

Mol	Chain	Residues	Atoms					AltConf	Trace
			Total	C	N	O	S		
43	AR	437	Total 3433	C 2155	N 585	O 667	S 26	0	0
43	AT	437	Total 3433	C 2155	N 585	O 667	S 26	0	0
43	AV	437	Total 3433	C 2155	N 585	O 667	S 26	0	0
43	AX	437	Total 3433	C 2155	N 585	O 667	S 26	0	0
43	BB	427	Total 3356	C 2109	N 575	O 646	S 26	0	0
43	BD	426	Total 3348	C 2105	N 574	O 643	S 26	0	0
43	BF	427	Total 3356	C 2109	N 575	O 646	S 26	0	0
43	BH	426	Total 3348	C 2105	N 574	O 643	S 26	0	0
43	BJ	430	Total 3373	C 2119	N 578	O 650	S 26	0	0
43	BL	426	Total 3348	C 2105	N 574	O 643	S 26	0	0
43	BN	426	Total 3348	C 2105	N 574	O 643	S 26	0	0
43	BP	427	Total 3356	C 2109	N 575	O 646	S 26	0	0
43	BR	426	Total 3348	C 2105	N 574	O 643	S 26	0	0
43	BT	427	Total 3356	C 2109	N 575	O 646	S 26	0	0
43	BV	426	Total 3348	C 2105	N 574	O 643	S 26	0	0
43	BX	430	Total 3373	C 2119	N 578	O 650	S 26	0	0
43	CB	428	Total 3361	C 2112	N 576	O 647	S 26	0	0
43	CD	426	Total 3348	C 2105	N 574	O 643	S 26	0	0
43	CF	427	Total 3356	C 2109	N 575	O 646	S 26	0	0
43	CH	426	Total 3348	C 2105	N 574	O 643	S 26	0	0
43	CJ	427	Total 3356	C 2109	N 575	O 646	S 26	0	0

Continued on next page...

Continued from previous page...

Mol	Chain	Residues	Atoms					AltConf	Trace
			Total	C	N	O	S		
43	CL	426	Total 3348	C 2105	N 574	O 643	S 26	0	0
43	CN	426	Total 3348	C 2105	N 574	O 643	S 26	0	0
43	CP	428	Total 3361	C 2112	N 576	O 647	S 26	0	0
43	CR	426	Total 3348	C 2105	N 574	O 643	S 26	0	0
43	CT	427	Total 3356	C 2109	N 575	O 646	S 26	0	0
43	CV	426	Total 3348	C 2105	N 574	O 643	S 26	0	0
43	CX	427	Total 3356	C 2109	N 575	O 646	S 26	0	0
43	CZ	426	Total 3348	C 2105	N 574	O 643	S 26	0	0
43	DB	426	Total 3348	C 2105	N 574	O 643	S 26	0	0
43	DD	426	Total 3348	C 2105	N 574	O 643	S 26	0	0
43	DF	426	Total 3348	C 2105	N 574	O 643	S 26	0	0
43	DH	426	Total 3348	C 2105	N 574	O 643	S 26	0	0
43	DJ	426	Total 3348	C 2105	N 574	O 643	S 26	0	0
43	DL	426	Total 3348	C 2105	N 574	O 643	S 26	0	0
43	DN	426	Total 3348	C 2105	N 574	O 643	S 26	0	0
43	DP	426	Total 3348	C 2105	N 574	O 643	S 26	0	0
43	DR	426	Total 3348	C 2105	N 574	O 643	S 26	0	0
43	DT	426	Total 3348	C 2105	N 574	O 643	S 26	0	0
43	DV	426	Total 3348	C 2105	N 574	O 643	S 26	0	0
43	DX	426	Total 3348	C 2105	N 574	O 643	S 26	0	0
43	DZ	426	Total 3348	C 2105	N 574	O 643	S 26	0	0

Continued on next page...

Continued from previous page...

Mol	Chain	Residues	Atoms					AltConf	Trace
			Total	C	N	O	S		
43	EB	426	Total 3348	C 2105	N 574	O 643	S 26	0	0
43	ED	426	Total 3348	C 2105	N 574	O 643	S 26	0	0
43	EF	426	Total 3348	C 2105	N 574	O 643	S 26	0	0
43	EH	426	Total 3348	C 2105	N 574	O 643	S 26	0	0
43	EJ	426	Total 3348	C 2105	N 574	O 643	S 26	0	0
43	EL	426	Total 3348	C 2105	N 574	O 643	S 26	0	0
43	EN	428	Total 3361	C 2112	N 576	O 647	S 26	0	0
43	EP	426	Total 3348	C 2105	N 574	O 643	S 26	0	0
43	ER	426	Total 3348	C 2105	N 574	O 643	S 26	0	0
43	ET	426	Total 3348	C 2105	N 574	O 643	S 26	0	0
43	EV	426	Total 3348	C 2105	N 574	O 643	S 26	0	0
43	EX	426	Total 3348	C 2105	N 574	O 643	S 26	0	0
43	EZ	426	Total 3348	C 2105	N 574	O 643	S 26	0	0
43	FB	426	Total 3348	C 2105	N 574	O 643	S 26	0	0
43	FD	426	Total 3348	C 2105	N 574	O 643	S 26	0	0
43	FF	426	Total 3348	C 2105	N 574	O 643	S 26	0	0
43	FH	426	Total 3348	C 2105	N 574	O 643	S 26	0	0
43	FJ	426	Total 3348	C 2105	N 574	O 643	S 26	0	0
43	FL	426	Total 3348	C 2105	N 574	O 643	S 26	0	0
43	FN	427	Total 3356	C 2109	N 575	O 646	S 26	0	0
43	FP	426	Total 3348	C 2105	N 574	O 643	S 26	0	0

Continued on next page...

Continued from previous page...

Mol	Chain	Residues	Atoms					AltConf	Trace
			Total	C	N	O	S		
43	FR	426	Total 3348	C 2105	N 574	O 643	S 26	0	0
43	FT	426	Total 3348	C 2105	N 574	O 643	S 26	0	0
43	FV	426	Total 3348	C 2105	N 574	O 643	S 26	0	0
43	FX	426	Total 3348	C 2105	N 574	O 643	S 26	0	0
43	FZ	426	Total 3348	C 2105	N 574	O 643	S 26	0	0
43	GB	426	Total 3348	C 2105	N 574	O 643	S 26	0	0
43	GD	426	Total 3348	C 2105	N 574	O 643	S 26	0	0
43	GF	426	Total 3348	C 2105	N 574	O 643	S 26	0	0
43	GH	426	Total 3348	C 2105	N 574	O 643	S 26	0	0
43	GJ	426	Total 3348	C 2105	N 574	O 643	S 26	0	0
43	GL	426	Total 3348	C 2105	N 574	O 643	S 26	0	0
43	GN	428	Total 3361	C 2112	N 576	O 647	S 26	0	0
43	GP	426	Total 3348	C 2105	N 574	O 643	S 26	0	0
43	GR	426	Total 3348	C 2105	N 574	O 643	S 26	0	0
43	GT	426	Total 3348	C 2105	N 574	O 643	S 26	0	0
43	GV	426	Total 3348	C 2105	N 574	O 643	S 26	0	0
43	GX	426	Total 3348	C 2105	N 574	O 643	S 26	0	0
43	GZ	426	Total 3348	C 2105	N 574	O 643	S 26	0	0
43	HB	411	Total 3214	C 2016	N 549	O 624	S 25	0	0
43	HD	426	Total 3348	C 2105	N 574	O 643	S 26	0	0
43	HF	426	Total 3348	C 2105	N 574	O 643	S 26	0	0

Continued on next page...

Continued from previous page...

Mol	Chain	Residues	Atoms					AltConf	Trace
			Total	C	N	O	S		
43	HH	426	Total 3348	C 2105	N 574	O 643	S 26	0	0
43	HJ	426	Total 3348	C 2105	N 574	O 643	S 26	0	0
43	HL	426	Total 3348	C 2105	N 574	O 643	S 26	0	0
43	HN	427	Total 3356	C 2109	N 575	O 646	S 26	0	0
43	HP	426	Total 3348	C 2105	N 574	O 643	S 26	0	0
43	HR	426	Total 3348	C 2105	N 574	O 643	S 26	0	0
43	HT	426	Total 3348	C 2105	N 574	O 643	S 26	0	0
43	HV	426	Total 3348	C 2105	N 574	O 643	S 26	0	0
43	HX	426	Total 3348	C 2105	N 574	O 643	S 26	0	0
43	HZ	426	Total 3348	C 2105	N 574	O 643	S 26	0	0
43	IB	426	Total 3348	C 2105	N 574	O 643	S 26	0	0
43	ID	426	Total 3348	C 2105	N 574	O 643	S 26	0	0
43	IF	426	Total 3348	C 2105	N 574	O 643	S 26	0	0
43	IH	426	Total 3348	C 2105	N 574	O 643	S 26	0	0
43	IJ	426	Total 3348	C 2105	N 574	O 643	S 26	0	0
43	IL	426	Total 3348	C 2105	N 574	O 643	S 26	0	0
43	IN	428	Total 3361	C 2112	N 576	O 647	S 26	0	0
43	IP	426	Total 3348	C 2105	N 574	O 643	S 26	0	0
43	IR	426	Total 3348	C 2105	N 574	O 643	S 26	0	0
43	IT	426	Total 3348	C 2105	N 574	O 643	S 26	0	0
43	IV	426	Total 3348	C 2105	N 574	O 643	S 26	0	0

Continued on next page...

Continued from previous page...

Mol	Chain	Residues	Atoms					AltConf	Trace
			Total	C	N	O	S		
43	IX	426	Total 3348	C 2105	N 574	O 643	S 26	0	0
43	JB	426	Total 3348	C 2105	N 574	O 643	S 26	0	0
43	JD	426	Total 3348	C 2105	N 574	O 643	S 26	0	0
43	JF	426	Total 3348	C 2105	N 574	O 643	S 26	0	0
43	JH	426	Total 3348	C 2105	N 574	O 643	S 26	0	0
43	JJ	426	Total 3348	C 2105	N 574	O 643	S 26	0	0
43	JL	426	Total 3348	C 2105	N 574	O 643	S 26	0	0
43	JN	428	Total 3361	C 2112	N 576	O 647	S 26	0	0
43	JP	426	Total 3348	C 2105	N 574	O 643	S 26	0	0
43	JR	426	Total 3348	C 2105	N 574	O 643	S 26	0	0
43	JT	426	Total 3348	C 2105	N 574	O 643	S 26	0	0
43	JV	426	Total 3348	C 2105	N 574	O 643	S 26	0	0
43	JX	426	Total 3348	C 2105	N 574	O 643	S 26	0	0
43	JZ	426	Total 3348	C 2105	N 574	O 643	S 26	0	0
43	KB	426	Total 3348	C 2105	N 574	O 643	S 26	0	0
43	KD	428	Total 3361	C 2112	N 576	O 647	S 26	0	0
43	KF	426	Total 3348	C 2105	N 574	O 643	S 26	0	0
43	KH	426	Total 3348	C 2105	N 574	O 643	S 26	0	0
43	KJ	426	Total 3348	C 2105	N 574	O 643	S 26	0	0
43	KL	427	Total 3356	C 2109	N 575	O 646	S 26	0	0
43	KN	428	Total 3361	C 2112	N 576	O 647	S 26	0	0

Continued on next page...

Continued from previous page...

Mol	Chain	Residues	Atoms					AltConf	Trace
			Total	C	N	O	S		
43	KP	428	Total 3361	C 2112	N 576	O 647	S 26	0	0
43	KR	428	Total 3361	C 2112	N 576	O 647	S 26	0	0
43	KT	428	Total 3361	C 2112	N 576	O 647	S 26	0	0
43	KV	426	Total 3348	C 2105	N 574	O 643	S 26	0	0
43	KX	428	Total 3361	C 2112	N 576	O 647	S 26	0	0
43	KZ	426	Total 3348	C 2105	N 574	O 643	S 26	0	0
43	LB	436	Total 3424	C 2150	N 584	O 664	S 26	0	0
43	LD	426	Total 3348	C 2105	N 574	O 643	S 26	0	0
43	LF	436	Total 3424	C 2150	N 584	O 664	S 26	0	0
43	LH	426	Total 3348	C 2105	N 574	O 643	S 26	0	0
43	LJ	436	Total 3424	C 2150	N 584	O 664	S 26	0	0
43	LL	426	Total 3348	C 2105	N 574	O 643	S 26	0	0
43	LN	436	Total 3424	C 2150	N 584	O 664	S 26	0	0
43	LP	428	Total 3361	C 2112	N 576	O 647	S 26	0	0
43	LR	436	Total 3424	C 2150	N 584	O 664	S 26	0	0
43	LT	426	Total 3348	C 2105	N 574	O 643	S 26	0	0
43	LV	436	Total 3424	C 2150	N 584	O 664	S 26	0	0
43	LX	426	Total 3348	C 2105	N 574	O 643	S 26	0	0
43	LZ	436	Total 3424	C 2150	N 584	O 664	S 26	0	0
43	MD	426	Total 3348	C 2105	N 574	O 643	S 26	0	0
43	MF	426	Total 3348	C 2105	N 574	O 643	S 26	0	0

Continued on next page...

Continued from previous page...

Mol	Chain	Residues	Atoms					AltConf	Trace
			Total	C	N	O	S		
43	MH	426	Total 3348	C 2105	N 574	O 643	S 26	0	0
43	MJ	426	Total 3348	C 2105	N 574	O 643	S 26	0	0
43	ML	426	Total 3348	C 2105	N 574	O 643	S 26	0	0
43	MN	427	Total 3356	C 2109	N 575	O 646	S 26	0	0
43	MP	426	Total 3348	C 2105	N 574	O 643	S 26	0	0
43	MR	426	Total 3348	C 2105	N 574	O 643	S 26	0	0
43	MT	426	Total 3348	C 2105	N 574	O 643	S 26	0	0
43	MV	426	Total 3348	C 2105	N 574	O 643	S 26	0	0
43	MX	426	Total 3348	C 2105	N 574	O 643	S 26	0	0
43	MZ	426	Total 3348	C 2105	N 574	O 643	S 26	0	0
43	NB	427	Total 3356	C 2109	N 575	O 646	S 26	0	0
43	ND	428	Total 3361	C 2112	N 576	O 647	S 26	0	0
43	NF	428	Total 3361	C 2112	N 576	O 647	S 26	0	0
43	NH	428	Total 3361	C 2112	N 576	O 647	S 26	0	0
43	NJ	428	Total 3361	C 2112	N 576	O 647	S 26	0	0
43	NL	428	Total 3361	C 2112	N 576	O 647	S 26	0	0
43	NN	428	Total 3361	C 2112	N 576	O 647	S 26	0	0
43	NP	428	Total 3361	C 2112	N 576	O 647	S 26	0	0
43	NR	428	Total 3361	C 2112	N 576	O 647	S 26	0	0
43	NT	426	Total 3348	C 2105	N 574	O 643	S 26	0	0
43	NV	428	Total 3361	C 2112	N 576	O 647	S 26	0	0

Continued on next page...

Continued from previous page...

Mol	Chain	Residues	Atoms					AltConf	Trace
			Total	C	N	O	S		
43	NX	428	Total 3361	C 2112	N 576	O 647	S 26	0	0
43	NZ	430	Total 3373	C 2119	N 578	O 650	S 26	0	0
43	OB	428	Total 3361	C 2112	N 576	O 647	S 26	0	0
43	OD	429	Total 3368	C 2116	N 577	O 649	S 26	0	0
43	OF	426	Total 3348	C 2105	N 574	O 643	S 26	0	0
43	OH	426	Total 3348	C 2105	N 574	O 643	S 26	0	0
43	OJ	428	Total 3361	C 2112	N 576	O 647	S 26	0	0
43	OL	426	Total 3348	C 2105	N 574	O 643	S 26	0	0
43	ON	428	Total 3361	C 2112	N 576	O 647	S 26	0	0
43	OP	428	Total 3361	C 2112	N 576	O 647	S 26	0	0
43	OR	427	Total 3356	C 2109	N 575	O 646	S 26	0	0
43	OT	426	Total 3348	C 2105	N 574	O 643	S 26	0	0
43	OV	428	Total 3361	C 2112	N 576	O 647	S 26	0	0
43	OX	426	Total 3348	C 2105	N 574	O 643	S 26	0	0
43	PB	426	Total 3348	C 2105	N 574	O 643	S 26	0	0
43	PD	428	Total 3361	C 2112	N 576	O 647	S 26	0	0
43	PF	428	Total 3361	C 2112	N 576	O 647	S 26	0	0
43	PH	426	Total 3348	C 2105	N 574	O 643	S 26	0	0
43	PJ	426	Total 3348	C 2105	N 574	O 643	S 26	0	0
43	PL	426	Total 3348	C 2105	N 574	O 643	S 26	0	0
43	PN	427	Total 3356	C 2109	N 575	O 646	S 26	0	0

Continued on next page...

Continued from previous page...

Mol	Chain	Residues	Atoms					AltConf	Trace
			Total	C	N	O	S		
43	PP	426	Total 3348	C 2105	N 574	O 643	S 26	0	0
43	PR	426	Total 3348	C 2105	N 574	O 643	S 26	0	0
43	PT	426	Total 3348	C 2105	N 574	O 643	S 26	0	0
43	PV	426	Total 3348	C 2105	N 574	O 643	S 26	0	0
43	PX	428	Total 3361	C 2112	N 576	O 647	S 26	0	0
43	QB	426	Total 3348	C 2105	N 574	O 643	S 26	0	0
43	QD	426	Total 3348	C 2105	N 574	O 643	S 26	0	0
43	QF	426	Total 3348	C 2105	N 574	O 643	S 26	0	0
43	QH	426	Total 3348	C 2105	N 574	O 643	S 26	0	0
43	QJ	426	Total 3348	C 2105	N 574	O 643	S 26	0	0
43	QL	426	Total 3348	C 2105	N 574	O 643	S 26	0	0
43	QN	428	Total 3361	C 2112	N 576	O 647	S 26	0	0
43	QP	426	Total 3348	C 2105	N 574	O 643	S 26	0	0
43	QR	426	Total 3348	C 2105	N 574	O 643	S 26	0	0
43	QT	426	Total 3348	C 2105	N 574	O 643	S 26	0	0
43	QV	426	Total 3348	C 2105	N 574	O 643	S 26	0	0
43	QX	426	Total 3348	C 2105	N 574	O 643	S 26	0	0
43	RB	426	Total 3348	C 2105	N 574	O 643	S 26	0	0
43	RD	426	Total 3348	C 2105	N 574	O 643	S 26	0	0
43	RF	426	Total 3348	C 2105	N 574	O 643	S 26	0	0
43	RH	426	Total 3348	C 2105	N 574	O 643	S 26	0	0

Continued on next page...

Continued from previous page...

Mol	Chain	Residues	Atoms					AltConf	Trace
			Total	C	N	O	S		
43	RJ	426	Total 3348	C 2105	N 574	O 643	S 26	0	0
43	RL	426	Total 3348	C 2105	N 574	O 643	S 26	0	0
43	RN	427	Total 3356	C 2109	N 575	O 646	S 26	0	0
43	RP	426	Total 3348	C 2105	N 574	O 643	S 26	0	0
43	RR	426	Total 3348	C 2105	N 574	O 643	S 26	0	0
43	RT	426	Total 3348	C 2105	N 574	O 643	S 26	0	0
43	RV	426	Total 3348	C 2105	N 574	O 643	S 26	0	0
43	RX	426	Total 3348	C 2105	N 574	O 643	S 26	0	0
43	SB	426	Total 3348	C 2105	N 574	O 643	S 26	0	0
43	SD	426	Total 3348	C 2105	N 574	O 643	S 26	0	0
43	SF	426	Total 3348	C 2105	N 574	O 643	S 26	0	0
43	SH	426	Total 3348	C 2105	N 574	O 643	S 26	0	0
43	SJ	426	Total 3348	C 2105	N 574	O 643	S 26	0	0
43	SL	426	Total 3348	C 2105	N 574	O 643	S 26	0	0
43	SN	428	Total 3361	C 2112	N 576	O 647	S 26	0	0
43	SP	426	Total 3348	C 2105	N 574	O 643	S 26	0	0
43	SR	426	Total 3348	C 2105	N 574	O 643	S 26	0	0
43	ST	426	Total 3348	C 2105	N 574	O 643	S 26	0	0
43	SV	426	Total 3348	C 2105	N 574	O 643	S 26	0	0
43	SX	426	Total 3348	C 2105	N 574	O 643	S 26	0	0
43	TB	426	Total 3348	C 2105	N 574	O 643	S 26	0	0

Continued on next page...

Continued from previous page...

Mol	Chain	Residues	Atoms					AltConf	Trace
			Total	C	N	O	S		
43	TD	426	Total 3348	C 2105	N 574	O 643	S 26	0	0
43	TF	426	Total 3348	C 2105	N 574	O 643	S 26	0	0
43	TH	426	Total 3348	C 2105	N 574	O 643	S 26	0	0
43	TJ	426	Total 3348	C 2105	N 574	O 643	S 26	0	0
43	TL	426	Total 3348	C 2105	N 574	O 643	S 26	0	0
43	TN	427	Total 3356	C 2109	N 575	O 646	S 26	0	0
43	TP	426	Total 3348	C 2105	N 574	O 643	S 26	0	0
43	TR	426	Total 3348	C 2105	N 574	O 643	S 26	0	0
43	TT	426	Total 3348	C 2105	N 574	O 643	S 26	0	0
43	TV	426	Total 3348	C 2105	N 574	O 643	S 26	0	0
43	TX	426	Total 3348	C 2105	N 574	O 643	S 26	0	0
43	TZ	426	Total 3348	C 2105	N 574	O 643	S 26	0	0
43	UB	426	Total 3348	C 2105	N 574	O 643	S 26	0	0
43	UD	426	Total 3348	C 2105	N 574	O 643	S 26	0	0
43	UF	426	Total 3348	C 2105	N 574	O 643	S 26	0	0
43	UH	426	Total 3348	C 2105	N 574	O 643	S 26	0	0
43	UJ	426	Total 3348	C 2105	N 574	O 643	S 26	0	0
43	UL	426	Total 3348	C 2105	N 574	O 643	S 26	0	0
43	UN	428	Total 3361	C 2112	N 576	O 647	S 26	0	0
43	UP	426	Total 3348	C 2105	N 574	O 643	S 26	0	0
43	UR	426	Total 3348	C 2105	N 574	O 643	S 26	0	0

Continued on next page...

Continued from previous page...

Mol	Chain	Residues	Atoms					AltConf	Trace
			Total	C	N	O	S		
43	UT	426	Total 3348	C 2105	N 574	O 643	S 26	0	0
43	UV	426	Total 3348	C 2105	N 574	O 643	S 26	0	0
43	UX	426	Total 3348	C 2105	N 574	O 643	S 26	0	0
43	UZ	426	Total 3348	C 2105	N 574	O 643	S 26	0	0
43	VB	426	Total 3348	C 2105	N 574	O 643	S 26	0	0
43	VD	426	Total 3348	C 2105	N 574	O 643	S 26	0	0
43	VF	426	Total 3348	C 2105	N 574	O 643	S 26	0	0
43	VH	426	Total 3348	C 2105	N 574	O 643	S 26	0	0
43	VJ	426	Total 3348	C 2105	N 574	O 643	S 26	0	0
43	VL	426	Total 3348	C 2105	N 574	O 643	S 26	0	0
43	VN	427	Total 3356	C 2109	N 575	O 646	S 26	0	0
43	VP	426	Total 3348	C 2105	N 574	O 643	S 26	0	0
43	VR	426	Total 3348	C 2105	N 574	O 643	S 26	0	0
43	VT	426	Total 3348	C 2105	N 574	O 643	S 26	0	0
43	VV	426	Total 3348	C 2105	N 574	O 643	S 26	0	0
43	VX	426	Total 3348	C 2105	N 574	O 643	S 26	0	0
43	VZ	426	Total 3348	C 2105	N 574	O 643	S 26	0	0
43	WB	437	Total 3433	C 2155	N 585	O 667	S 26	0	0
43	WD	437	Total 3433	C 2155	N 585	O 667	S 26	0	0
43	WF	437	Total 3433	C 2155	N 585	O 667	S 26	0	0
43	WH	437	Total 3433	C 2155	N 585	O 667	S 26	0	0

Continued on next page...

Continued from previous page...

Mol	Chain	Residues	Atoms					AltConf	Trace
43	WJ	434	Total	C	N	O	S	0	0
			3404	2136	582	660	26		
43	WL	434	Total	C	N	O	S	0	0
			3404	2136	582	660	26		
43	WN	437	Total	C	N	O	S	0	0
			3433	2155	585	667	26		
43	WP	437	Total	C	N	O	S	0	0
			3433	2155	585	667	26		
43	WR	437	Total	C	N	O	S	0	0
			3433	2155	585	667	26		
43	WT	437	Total	C	N	O	S	0	0
			3433	2155	585	667	26		
43	WV	437	Total	C	N	O	S	0	0
			3433	2155	585	667	26		
43	WX	437	Total	C	N	O	S	0	0
			3433	2155	585	667	26		

- Molecule 44 is a protein called Radial spoke head protein 3 homolog.

Mol	Chain	Residues	Atoms					AltConf	Trace
44	E	169	Total	C	N	O	S	0	0
			1405	876	250	272	7		
44	F	217	Total	C	N	O	S	0	0
			1795	1125	311	350	9		
44	e	216	Total	C	N	O	S	0	0
			1783	1116	310	348	9		
44	f	213	Total	C	N	O	S	0	0
			1761	1104	304	344	9		

- Molecule 45 is a protein called Radial spoke head protein 4 homolog A.

Mol	Chain	Residues	Atoms					AltConf	Trace
45	G	460	Total	C	N	O	S	0	0
			3714	2353	600	753	8		
45	H	467	Total	C	N	O	S	0	0
			3767	2387	607	764	9		
45	I	464	Total	C	N	O	S	0	0
			3746	2374	604	760	8		
45	J	470	Total	C	N	O	S	0	0
			3788	2400	610	769	9		
45	g	466	Total	C	N	O	S	0	0
			3760	2382	606	763	9		

Continued on next page...

Continued from previous page...

Mol	Chain	Residues	Atoms					AltConf	Trace
45	h	470	Total	C	N	O	S	0	0
			3788	2400	610	769	9		
45	i	468	Total	C	N	O	S	0	0
			3772	2390	608	765	9		
45	j	470	Total	C	N	O	S	0	0
			3788	2400	610	769	9		

- Molecule 46 is a protein called Sperm surface protein Sp17.

Mol	Chain	Residues	Atoms				AltConf	Trace
46	K	32	Total	C	N	O	0	0
			255	166	41	48		
46	L	35	Total	C	N	O	0	0
			277	178	45	54		
46	k	32	Total	C	N	O	0	0
			255	166	41	48		
46	l	38	Total	C	N	O	0	0
			306	195	52	59		

- Molecule 47 is a protein called Radial spoke head protein 9 homolog.

Mol	Chain	Residues	Atoms					AltConf	Trace
47	M	276	Total	C	N	O	S	0	0
			2205	1412	366	418	9		
47	N	257	Total	C	N	O	S	0	0
			2050	1314	343	384	9		
47	O	276	Total	C	N	O	S	0	0
			2205	1412	366	418	9		
47	P	262	Total	C	N	O	S	0	0
			2088	1339	348	392	9		
47	m	276	Total	C	N	O	S	0	0
			2205	1412	366	418	9		
47	n	262	Total	C	N	O	S	0	0
			2088	1339	348	392	9		
47	o	276	Total	C	N	O	S	0	0
			2205	1412	366	418	9		
47	p	262	Total	C	N	O	S	0	0
			2088	1339	348	392	9		

- Molecule 48 is a protein called Ropporin-1-like protein.

Mol	Chain	Residues	Atoms					AltConf	Trace
48	Q	174	Total	C	N	O	S	0	0
			1392	896	240	246	10		
48	R	37	Total	C	N	O		0	0
			300	196	52	52			
48	q	206	Total	C	N	O	S	0	0
			1641	1053	279	298	11		
48	r	42	Total	C	N	O	S	0	0
			330	214	57	58	1		

- Molecule 49 is a protein called Probable inactive peptidyl-prolyl cis-trans isomerase-like 6.

Mol	Chain	Residues	Atoms					AltConf	Trace
49	S	290	Total	C	N	O	S	0	0
			2336	1496	400	431	9		
49	s	290	Total	C	N	O	S	0	0
			2336	1496	400	431	9		

- Molecule 50 is a protein called Radial spoke head 14 homolog.

Mol	Chain	Residues	Atoms					AltConf	Trace
50	T	336	Total	C	N	O	S	0	0
			2612	1660	451	485	16		
50	t	325	Total	C	N	O	S	0	0
			2528	1608	437	467	16		

- Molecule 51 is a protein called DnaJ homolog subfamily B member 13.

Mol	Chain	Residues	Atoms					AltConf	Trace
51	U	296	Total	C	N	O	S	0	0
			2397	1540	415	435	7		
51	V	297	Total	C	N	O	S	0	0
			2406	1545	417	437	7		
51	u	296	Total	C	N	O	S	0	0
			2397	1540	415	435	7		
51	v	297	Total	C	N	O	S	0	0
			2406	1545	417	437	7		

- Molecule 52 is a protein called Calmodulin-1.

Mol	Chain	Residues	Atoms					AltConf	Trace
52	W	142	Total	C	N	O	S	0	0
			1121	687	180	245	9		

- Molecule 53 is a protein called Nucleoside diphosphate kinase homolog 5.

Mol	Chain	Residues	Atoms					AltConf	Trace
53	X	192	Total	C	N	O	S	0	0
			1537	993	259	277	8		
53	Y	192	Total	C	N	O	S	0	0
			1537	993	259	277	8		
53	x	192	Total	C	N	O	S	0	0
			1537	993	259	277	8		
53	y	192	Total	C	N	O	S	0	0
			1537	993	259	277	8		

- Molecule 54 is a protein called Cilia- and flagella-associated protein 20.

Mol	Chain	Residues	Atoms					AltConf	Trace
54	XA	186	Total	C	N	O	S	0	0
			1549	998	270	274	7		
54	XB	186	Total	C	N	O	S	0	0
			1549	998	270	274	7		
54	XC	186	Total	C	N	O	S	0	0
			1549	998	270	274	7		
54	XD	186	Total	C	N	O	S	0	0
			1549	998	270	274	7		
54	XE	186	Total	C	N	O	S	0	0
			1549	998	270	274	7		
54	XF	186	Total	C	N	O	S	0	0
			1549	998	270	274	7		
54	XG	186	Total	C	N	O	S	0	0
			1549	998	270	274	7		
54	XH	186	Total	C	N	O	S	0	0
			1549	998	270	274	7		
54	XI	186	Total	C	N	O	S	0	0
			1549	998	270	274	7		
54	XJ	186	Total	C	N	O	S	0	0
			1549	998	270	274	7		
54	XK	186	Total	C	N	O	S	0	0
			1549	998	270	274	7		
54	XL	186	Total	C	N	O	S	0	0
			1549	998	270	274	7		
54	XM	186	Total	C	N	O	S	0	0
			1549	998	270	274	7		

- Molecule 55 is a protein called Parkin coregulated gene protein.

Mol	Chain	Residues	Atoms					AltConf	Trace
55	YB	220	Total	C	N	O	S	0	0
			1771	1147	301	314	9		
55	YC	220	Total	C	N	O	S	0	0
			1771	1147	301	314	9		
55	YD	220	Total	C	N	O	S	0	0
			1771	1147	301	314	9		
55	YF	220	Total	C	N	O	S	0	0
			1771	1147	301	314	9		
55	YG	220	Total	C	N	O	S	0	0
			1771	1147	301	314	9		
55	YH	220	Total	C	N	O	S	0	0
			1771	1147	301	314	9		
55	YI	220	Total	C	N	O	S	0	0
			1771	1147	301	314	9		
55	YJ	220	Total	C	N	O	S	0	0
			1771	1147	301	314	9		
55	YK	220	Total	C	N	O	S	0	0
			1771	1147	301	314	9		
55	YL	220	Total	C	N	O	S	0	0
			1771	1147	301	314	9		
55	YM	220	Total	C	N	O	S	0	0
			1771	1147	301	314	9		

- Molecule 56 is a protein called Cytochrome b5 domain-containing protein 1.

Mol	Chain	Residues	Atoms					AltConf	Trace
56	Z	214	Total	C	N	O	S	0	0
			1784	1145	303	331	5		
56	z	209	Total	C	N	O	S	0	0
			1735	1111	297	322	5		

- Molecule 57 is a protein called Unknown.

Mol	Chain	Residues	Atoms				AltConf	Trace
57	a0	72	Total	C	N	O	0	0
			360	216	72	72		

- Molecule 58 is a protein called DYNLL1.

Mol	Chain	Residues	Atoms					AltConf	Trace
58	a1	83	Total	C	N	O	S	0	0
			680	438	112	126	4		

Continued on next page...

Continued from previous page...

Mol	Chain	Residues	Atoms					AltConf	Trace
			Total	C	N	O	S		
58	a2	84	685	441	113	127	4	0	0
58	a3	83	684	442	113	125	4	0	0
58	a4	88	719	460	121	133	5	0	0
58	a5	84	690	445	114	127	4	0	0
58	a6	83	681	439	112	126	4	0	0
58	a7	85	694	447	115	128	4	0	0
58	a8	86	705	453	119	129	4	0	0
58	a9	85	694	447	115	128	4	0	0
58	b0	89	727	465	122	134	6	0	0
58	b1	85	694	447	115	128	4	0	0
58	b2	89	727	465	122	134	6	0	0
58	b3	87	717	460	120	131	6	0	0
58	b4	84	695	448	117	126	4	0	0
58	b5	84	695	448	117	126	4	0	0
58	b6	83	684	442	113	125	4	0	0
58	b7	86	705	453	119	129	4	0	0
58	b8	87	713	457	120	132	4	0	0
58	b9	89	727	465	122	134	6	0	0
58	c0	85	694	447	115	128	4	0	0
58	l1	89	727	465	122	134	6	0	0
58	l2	89	727	465	122	134	6	0	0

Continued on next page...

Continued from previous page...

Mol	Chain	Residues	Atoms				AltConf	Trace	
58	l3	89	Total 727	C 465	N 122	O 134	S 6	0	0
58	l4	89	Total 727	C 465	N 122	O 134	S 6	0	0
58	l5	89	Total 727	C 465	N 122	O 134	S 6	0	0
58	l6	89	Total 727	C 465	N 122	O 134	S 6	0	0
58	n1	89	Total 727	C 465	N 122	O 134	S 6	0	0
58	n2	89	Total 727	C 465	N 122	O 134	S 6	0	0
58	n3	89	Total 727	C 465	N 122	O 134	S 6	0	0
58	n4	89	Total 727	C 465	N 122	O 134	S 6	0	0
58	n5	89	Total 727	C 465	N 122	O 134	S 6	0	0
58	n6	89	Total 727	C 465	N 122	O 134	S 6	0	0
58	p1	89	Total 727	C 465	N 122	O 134	S 6	0	0
58	p2	89	Total 727	C 465	N 122	O 134	S 6	0	0
58	p3	89	Total 727	C 465	N 122	O 134	S 6	0	0
58	p4	89	Total 727	C 465	N 122	O 134	S 6	0	0
58	p5	89	Total 727	C 465	N 122	O 134	S 6	0	0
58	p6	89	Total 727	C 465	N 122	O 134	S 6	0	0
58	r1	89	Total 727	C 465	N 122	O 134	S 6	0	0
58	r2	89	Total 727	C 465	N 122	O 134	S 6	0	0
58	r3	89	Total 727	C 465	N 122	O 134	S 6	0	0
58	r4	89	Total 727	C 465	N 122	O 134	S 6	0	0
58	r5	89	Total 727	C 465	N 122	O 134	S 6	0	0

Continued on next page...

Continued from previous page...

Mol	Chain	Residues	Atoms					AltConf	Trace
			Total	C	N	O	S		
58	r6	89	727	465	122	134	6	0	0

- Molecule 59 is a protein called MORN repeat-containing protein 3.

Mol	Chain	Residues	Atoms					AltConf	Trace
			Total	C	N	O	S		
59	c1	228	1858	1178	329	341	10	0	0

- Molecule 60 is a protein called IQ and ubiquitin-like domain-containing protein.

Mol	Chain	Residues	Atoms					AltConf	Trace
			Total	C	N	O	S		
60	c2	631	5234	3355	910	948	21	0	0

- Molecule 61 is a protein called DPY30 domain-containing protein 2.

Mol	Chain	Residues	Atoms					AltConf	Trace
			Total	C	N	O	S		
61	c3	44	363	234	64	62	3	0	0
61	c4	55	458	292	83	80	3	0	0
61	c5	61	515	328	92	92	3	0	0
61	c6	61	515	328	92	92	3	0	0

- Molecule 62 is a protein called Cilia- and flagella-associated protein 61.

Mol	Chain	Residues	Atoms					AltConf	Trace
			Total	C	N	O	S		
62	d0	1092	8819	5669	1488	1608	54	0	0

- Molecule 63 is a protein called Cilia- and flagella-associated protein 91.

Mol	Chain	Residues	Atoms					AltConf	Trace
			Total	C	N	O	S		
63	d1	523	4340	2753	774	794	19	0	0

- Molecule 64 is a protein called Cilia- and flagella-associated protein 251.

Mol	Chain	Residues	Atoms					AltConf	Trace
			Total	C	N	O	S		
64	d2	907	7227	4652	1193	1342	40	0	0

- Molecule 65 is a protein called Tetratricopeptide repeat protein 29.

Mol	Chain	Residues	Atoms					AltConf	Trace
			Total	C	N	O	S		
65	d3	419	3431	2178	578	654	21	0	0

- Molecule 66 is a protein called Zinc finger MYND domain-containing protein 12.

Mol	Chain	Residues	Atoms					AltConf	Trace
			Total	C	N	O	S		
66	d4	358	2885	1846	485	537	17	0	0

- Molecule 67 is a protein called ACTA2.

Mol	Chain	Residues	Atoms					AltConf	Trace
			Total	C	N	O	S		
67	d5	377	2944	1859	495	567	23	0	0
67	d6	377	2944	1859	495	567	23	0	0
67	d7	370	2889	1829	488	551	21	0	0
67	d8	377	2944	1859	495	567	23	0	0
67	d9	367	2864	1813	485	546	20	0	0
67	f1	371	2895	1832	489	553	21	0	0

- Molecule 68 is a protein called Axonemal dynein light intermediate polypeptide 1.

Mol	Chain	Residues	Atoms					AltConf	Trace
			Total	C	N	O	S		
68	e0	209	1713	1060	312	333	8	0	0
68	e1	198	1635	1009	299	319	8	0	0
68	e2	209	1713	1060	312	333	8	0	0
68	e3	198	1635	1009	299	319	8	0	0

Continued on next page...

Continued from previous page...

Mol	Chain	Residues	Atoms					AltConf	Trace
68	e4	200	Total	C	N	O	S	0	0
			1645	1017	302	318	8		
68	e5	199	Total	C	N	O	S	0	0
			1639	1012	299	319	9		
68	e6	199	Total	C	N	O	S	0	0
			1639	1013	299	319	8		
68	e7	198	Total	C	N	O	S	0	0
			1635	1009	299	319	8		
68	e8	209	Total	C	N	O	S	0	0
			1713	1060	312	333	8		
68	e9	198	Total	C	N	O	S	0	0
			1635	1009	299	319	8		

- Molecule 69 is a protein called Centrin-2.

Mol	Chain	Residues	Atoms					AltConf	Trace
69	f2	147	Total	C	N	O	S	0	0
			1183	739	191	246	7		

- Molecule 70 is a protein called Dynein axonemal heavy chain 12.

Mol	Chain	Residues	Atoms					AltConf	Trace
70	g1	3939	Total	C	N	O	S	0	0
			31794	20376	5309	5921	188		

- Molecule 71 is a protein called Dynein axonemal heavy chain 7.

Mol	Chain	Residues	Atoms					AltConf	Trace
71	g2	507	Total	C	N	O	S	0	0
			4176	2676	697	775	28		
71	g4	437	Total	C	N	O	S	0	0
			3610	2320	604	664	22		

- Molecule 72 is a protein called Dynein axonemal heavy chain 3.

Mol	Chain	Residues	Atoms					AltConf	Trace
72	g3	571	Total	C	N	O	S	0	0
			4660	2997	783	849	31		

- Molecule 73 is a protein called Dynein axonemal heavy chain 6.

Mol	Chain	Residues	Atoms					AltConf	Trace
			Total	C	N	O	S		
73	g5	3978	32054	20492	5401	5990	171	0	0

- Molecule 74 is a protein called Dynein axonemal heavy chain 1.

Mol	Chain	Residues	Atoms					AltConf	Trace
			Total	C	N	O	S		
74	g6	4174	33600	21465	5650	6286	199	0	0

- Molecule 75 is a protein called Coiled-coil domain-containing protein 39.

Mol	Chain	Residues	Atoms					AltConf	Trace
			Total	C	N	O	S		
75	h1	388	3183	1954	570	648	11	0	0
75	h2	475	3959	2468	689	784	18	0	0

- Molecule 76 is a protein called Coiled-coil domain-containing protein 40.

Mol	Chain	Residues	Atoms					AltConf	Trace
			Total	C	N	O	S		
76	h3	387	3152	1944	578	613	17	0	0
76	h4	480	3932	2425	732	757	18	0	0

- Molecule 77 is a protein called Coiled-coil domain-containing protein 96.

Mol	Chain	Residues	Atoms					AltConf	Trace
			Total	C	N	O	S		
77	i1	305	2509	1552	477	467	13	0	0

- Molecule 78 is a protein called Coiled-coil domain-containing protein 113.

Mol	Chain	Residues	Atoms					AltConf	Trace
			Total	C	N	O	S		
78	i2	364	2998	1866	548	570	14	0	0

- Molecule 79 is a protein called Cilia- and flagella-associated protein 299.

Mol	Chain	Residues	Atoms					AltConf	Trace
			Total	C	N	O	S		
79	i3	194	1592	1006	274	311	1	0	0

- Molecule 80 is a protein called Cilia- and flagella-associated protein 57.

Mol	Chain	Residues	Atoms					AltConf	Trace
			Total	C	N	O	S		
80	i4	1021	Total	C	N	O	S	0	0
			8344	5265	1440	1599	40		
80	i5	1049	Total	C	N	O	S	0	0
			8561	5402	1477	1641	41		

- Molecule 81 is a protein called Cilia- and flagella-associated protein 43.

Mol	Chain	Residues	Atoms					AltConf	Trace
			Total	C	N	O	S		
81	i6	165	Total	C	N	O	S	0	0
			1363	854	240	255	14		
81	i8	1379	Total	C	N	O	S	0	0
			11188	7146	1869	2111	62		

- Molecule 82 is a protein called Cilia- and flagella-associated protein 44.

Mol	Chain	Residues	Atoms					AltConf	Trace
			Total	C	N	O	S		
82	i7	160	Total	C	N	O	S	0	0
			1326	826	248	242	10		
82	i9	1338	Total	C	N	O	S	0	0
			10895	6968	1841	2028	58		

- Molecule 83 is a protein called Cilia- and flagella-associated protein 58.

Mol	Chain	Residues	Atoms					AltConf	Trace
			Total	C	N	O	S		
83	j1	458	Total	C	N	O	S	0	0
			3859	2403	710	734	12		
83	j2	471	Total	C	N	O	S	0	0
			3973	2477	732	752	12		

- Molecule 84 is a protein called Cilia- and flagella-associated protein 73.

Mol	Chain	Residues	Atoms					AltConf	Trace
			Total	C	N	O	S		
84	j3	254	Total	C	N	O	S	0	0
			2104	1304	412	383	5		

- Molecule 85 is a protein called Cilia- and flagella-associated protein 100.

Mol	Chain	Residues	Atoms					AltConf	Trace
			Total	C	N	O	S		
85	j4	244	Total	C	N	O	S	0	0
			2021	1266	342	404	9		

- Molecule 86 is a protein called Dynein axonemal intermediate chain 3.

Mol	Chain	Residues	Atoms					AltConf	Trace
			Total	C	N	O	S		
86	k1	590	4743	3035	781	897	30	0	0

- Molecule 87 is a protein called Dynein axonemal intermediate chain 4.

Mol	Chain	Residues	Atoms					AltConf	Trace
			Total	C	N	O	S		
87	k2	500	3991	2544	673	749	25	0	0

- Molecule 88 is a protein called Dynein axonemal intermediate chain 7.

Mol	Chain	Residues	Atoms					AltConf	Trace
			Total	C	N	O	S		
88	k3	497	4044	2608	666	751	19	0	0

- Molecule 89 is a protein called Dynein light chain roadblock-type 1.

Mol	Chain	Residues	Atoms					AltConf	Trace
			Total	C	N	O	S		
89	k4	96	764	481	131	148	4	0	0
89	m4	96	764	481	131	148	4	0	0
89	o4	96	764	481	131	148	4	0	0
89	q4	96	764	481	131	148	4	0	0

- Molecule 90 is a protein called Dynein light chain roadblock-type 2.

Mol	Chain	Residues	Atoms					AltConf	Trace
			Total	C	N	O	S		
90	k5	96	758	476	134	143	5	0	0
90	m5	96	758	476	134	143	5	0	0
90	o5	96	758	476	134	143	5	0	0
90	q5	96	758	476	134	143	5	0	0

- Molecule 91 is a protein called Dynein axonemal heavy chain 10.

Mol	Chain	Residues	Atoms					AltConf	Trace
			Total	C	N	O	S		
91	k8	4443	36045	23070	6109	6666	200	0	0

- Molecule 92 is a protein called Dynein axonemal heavy chain 2.

Mol	Chain	Residues	Atoms					AltConf	Trace
			Total	C	N	O	S		
92	k9	4349	35139	22447	6004	6497	191	0	0

- Molecule 93 is a protein called Dynein light chain Tctex-type protein 2B.

Mol	Chain	Residues	Atoms					AltConf	Trace
			Total	C	N	O	S		
93	l7	105	854	545	141	159	9	0	0
93	n7	113	924	592	154	169	9	0	0
93	p7	113	924	592	154	169	9	0	0
93	r7	113	924	592	154	169	9	0	0

- Molecule 94 is a protein called Dynein light chain Tctex-type 1.

Mol	Chain	Residues	Atoms					AltConf	Trace
			Total	C	N	O	S		
94	l8	102	785	497	130	152	6	0	0
94	n8	103	790	500	131	153	6	0	0
94	p8	103	790	500	131	153	6	0	0
94	r8	90	687	435	117	129	6	0	0

- Molecule 95 is a protein called Calaxin.

Mol	Chain	Residues	Atoms					AltConf	Trace
			Total	C	N	O	S		
95	m0	211	1716	1091	284	326	15	0	0
95	q0	211	1716	1091	284	326	15	0	0
95	s0	211	1716	1091	284	326	15	0	0

Continued on next page...

Continued from previous page...

Mol	Chain	Residues	Atoms					AltConf	Trace
			Total	C	N	O	S		
95	u0	211	1716	1091	284	326	15	0	0

- Molecule 96 is a protein called Dynein axonemal intermediate chain 1.

Mol	Chain	Residues	Atoms					AltConf	Trace
			Total	C	N	O	S		
96	m1	527	4241	2704	729	788	20	0	0
96	o1	527	4241	2704	729	788	20	0	0
96	q1	527	4241	2704	729	788	20	0	0
96	s1	414	3320	2132	557	612	19	0	0

- Molecule 97 is a protein called Dynein axonemal intermediate chain 2.

Mol	Chain	Residues	Atoms					AltConf	Trace
			Total	C	N	O	S		
97	m2	529	4233	2669	723	812	29	0	0
97	o2	529	4233	2669	723	812	29	0	0
97	q2	529	4233	2669	723	812	29	0	0
97	s2	398	3161	2002	538	600	21	0	0

- Molecule 98 is a protein called Dynein axonemal light chain 1.

Mol	Chain	Residues	Atoms					AltConf	Trace
			Total	C	N	O	S		
98	m3	190	1509	960	254	287	8	0	0
98	o3	190	1509	960	254	287	8	0	0
98	q3	190	1509	960	254	287	8	0	0

- Molecule 99 is a protein called Outer dynein arm-docking complex subunit 1.

Mol	Chain	Residues	Atoms					AltConf	Trace
			Total	C	N	O	S		
99	m6	349	2926	1816	554	547	9	0	0

Continued on next page...

Continued from previous page...

Mol	Chain	Residues	Atoms					AltConf	Trace
99	o6	189	Total	C	N	O	S	0	0
			1567	986	278	297	6		
99	q6	349	Total	C	N	O	S	0	0
			2926	1816	554	547	9		
99	s6	349	Total	C	N	O	S	0	0
			2926	1816	554	547	9		
99	u6	212	Total	C	N	O	S	0	0
			1772	1085	352	330	5		

- Molecule 100 is a protein called Outer dynein arm-docking complex subunit 2.

Mol	Chain	Residues	Atoms					AltConf	Trace
100	m7	599	Total	C	N	O	S	0	0
			4591	2866	832	861	32		
100	q7	599	Total	C	N	O	S	0	0
			4591	2866	832	861	32		
100	s7	599	Total	C	N	O	S	0	0
			4591	2866	832	861	32		
100	u7	599	Total	C	N	O	S	0	0
			4591	2866	832	861	32		

- Molecule 101 is a protein called Outer dynein arm-docking complex subunit 3.

Mol	Chain	Residues	Atoms					AltConf	Trace
101	m8	419	Total	C	N	O	S	0	0
			3484	2160	657	655	12		
101	o8	239	Total	C	N	O	S	0	0
			1970	1214	370	378	8		
101	q8	419	Total	C	N	O	S	0	0
			3484	2160	657	655	12		
101	s8	419	Total	C	N	O	S	0	0
			3484	2160	657	655	12		
101	u8	231	Total	C	N	O	S	0	0
			1944	1210	370	359	5		

- Molecule 102 is a protein called Outer dynein arm-docking complex subunit 4.

Mol	Chain	Residues	Atoms					AltConf	Trace
102	m9	204	Total	C	N	O	S	0	0
			1656	1048	285	313	10		
102	q9	204	Total	C	N	O	S	0	0
			1656	1048	285	313	10		

Continued on next page...

Continued from previous page...

Mol	Chain	Residues	Atoms					AltConf	Trace
102	s9	204	Total	C	N	O	S	0	0
			1656	1048	285	313	10		
102	u9	204	Total	C	N	O	S	0	0
			1656	1048	285	313	10		

- Molecule 103 is a protein called Dynein axonemal heavy chain 5.

Mol	Chain	Residues	Atoms					AltConf	Trace
103	n0	4575	Total	C	N	O	S	0	0
			36802	23465	6234	6895	208		
103	p0	4575	Total	C	N	O	S	0	0
			36802	23465	6234	6895	208		
103	r0	4575	Total	C	N	O	S	0	0
			36802	23465	6234	6895	208		
103	t0	836	Total	C	N	O	S	0	0
			6751	4318	1150	1251	32		

- Molecule 104 is a protein called Dynein axonemal heavy chain 9.

Mol	Chain	Residues	Atoms					AltConf	Trace
104	n9	4486	Total	C	N	O	S	0	0
			36021	22986	6125	6720	190		
104	p9	4486	Total	C	N	O	S	0	0
			36021	22986	6125	6720	190		
104	r9	4486	Total	C	N	O	S	0	0
			36021	22986	6125	6720	190		
104	t9	718	Total	C	N	O	S	0	0
			5742	3642	1001	1072	27		

- Molecule 105 is a protein called Thioredoxin domain-containing protein 6.

Mol	Chain	Residues	Atoms					AltConf	Trace
105	v1	133	Total	C	N	O	S	0	0
			1043	664	173	200	6		
105	v2	133	Total	C	N	O	S	0	0
			1043	664	173	200	6		
105	v3	133	Total	C	N	O	S	0	0
			1043	664	173	200	6		

- Molecule 106 is a protein called Leucine-rich repeat-containing protein 34.

Mol	Chain	Residues	Atoms					AltConf	Trace
			Total	C	N	O	S		
106	w	412	3229	2048	546	614	21	0	0

- Molecule 107 is GUANOSINE-5'-TRIPHOSPHATE (three-letter code: GTP) (formula: $C_{10}H_{16}N_5O_{14}P_3$).

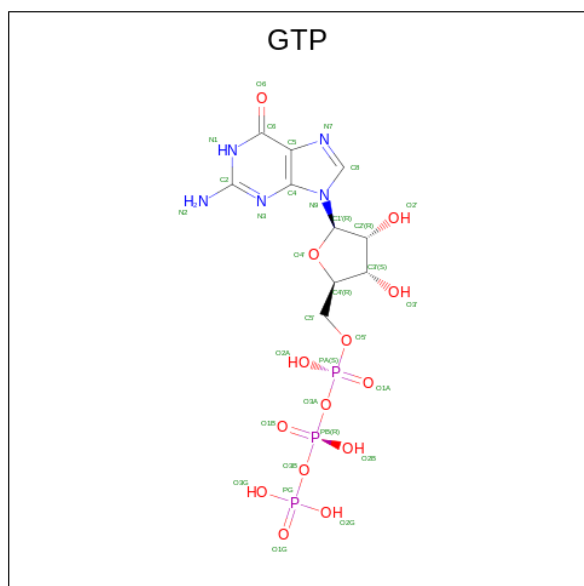

Mol	Chain	Residues	Atoms					AltConf
			Total	C	N	O	P	
107	AZ	1	Total	C	N	O	P	0
			32	10	5	14	3	
107	AC	1	Total	C	N	O	P	0
			32	10	5	14	3	
107	AE	1	Total	C	N	O	P	0
			32	10	5	14	3	
107	AG	1	Total	C	N	O	P	0
			32	10	5	14	3	
107	AI	1	Total	C	N	O	P	0
			32	10	5	14	3	
107	AK	1	Total	C	N	O	P	0
			32	10	5	14	3	
107	AM	1	Total	C	N	O	P	0
			32	10	5	14	3	
107	AO	1	Total	C	N	O	P	0
			32	10	5	14	3	
107	AQ	1	Total	C	N	O	P	0
			32	10	5	14	3	
107	AS	1	Total	C	N	O	P	0
			32	10	5	14	3	

Continued on next page...

Continued from previous page...

Mol	Chain	Residues	Atoms					AltConf
			Total	C	N	O	P	
107	AU	1	Total 32	C 10	N 5	O 14	P 3	0
107	AW	1	Total 32	C 10	N 5	O 14	P 3	0
107	AY	1	Total 32	C 10	N 5	O 14	P 3	0
107	BA	1	Total 32	C 10	N 5	O 14	P 3	0
107	BC	1	Total 32	C 10	N 5	O 14	P 3	0
107	BE	1	Total 32	C 10	N 5	O 14	P 3	0
107	BG	1	Total 32	C 10	N 5	O 14	P 3	0
107	BI	1	Total 32	C 10	N 5	O 14	P 3	0
107	BK	1	Total 32	C 10	N 5	O 14	P 3	0
107	BM	1	Total 32	C 10	N 5	O 14	P 3	0
107	BO	1	Total 32	C 10	N 5	O 14	P 3	0
107	BQ	1	Total 32	C 10	N 5	O 14	P 3	0
107	BS	1	Total 32	C 10	N 5	O 14	P 3	0
107	BU	1	Total 32	C 10	N 5	O 14	P 3	0
107	BW	1	Total 32	C 10	N 5	O 14	P 3	0
107	BY	1	Total 32	C 10	N 5	O 14	P 3	0
107	CC	1	Total 32	C 10	N 5	O 14	P 3	0
107	CE	1	Total 32	C 10	N 5	O 14	P 3	0
107	CG	1	Total 32	C 10	N 5	O 14	P 3	0
107	CI	1	Total 32	C 10	N 5	O 14	P 3	0
107	CK	1	Total 32	C 10	N 5	O 14	P 3	0

Continued on next page...

Continued from previous page...

Mol	Chain	Residues	Atoms					AltConf
			Total	C	N	O	P	
107	CM	1	Total 32	C 10	N 5	O 14	P 3	0
107	CO	1	Total 32	C 10	N 5	O 14	P 3	0
107	CQ	1	Total 32	C 10	N 5	O 14	P 3	0
107	CS	1	Total 32	C 10	N 5	O 14	P 3	0
107	CU	1	Total 32	C 10	N 5	O 14	P 3	0
107	CW	1	Total 32	C 10	N 5	O 14	P 3	0
107	CY	1	Total 32	C 10	N 5	O 14	P 3	0
107	DC	1	Total 32	C 10	N 5	O 14	P 3	0
107	DE	1	Total 32	C 10	N 5	O 14	P 3	0
107	DG	1	Total 32	C 10	N 5	O 14	P 3	0
107	DI	1	Total 32	C 10	N 5	O 14	P 3	0
107	DK	1	Total 32	C 10	N 5	O 14	P 3	0
107	DM	1	Total 32	C 10	N 5	O 14	P 3	0
107	DO	1	Total 32	C 10	N 5	O 14	P 3	0
107	DQ	1	Total 32	C 10	N 5	O 14	P 3	0
107	DS	1	Total 32	C 10	N 5	O 14	P 3	0
107	DU	1	Total 32	C 10	N 5	O 14	P 3	0
107	DW	1	Total 32	C 10	N 5	O 14	P 3	0
107	DY	1	Total 32	C 10	N 5	O 14	P 3	0
107	EC	1	Total 32	C 10	N 5	O 14	P 3	0
107	EE	1	Total 32	C 10	N 5	O 14	P 3	0

Continued on next page...

Continued from previous page...

Mol	Chain	Residues	Atoms					AltConf
			Total	C	N	O	P	
107	EG	1	Total 32	10	5	14	3	0
107	EI	1	Total 32	10	5	14	3	0
107	EK	1	Total 32	10	5	14	3	0
107	EM	1	Total 32	10	5	14	3	0
107	EO	1	Total 32	10	5	14	3	0
107	EQ	1	Total 32	10	5	14	3	0
107	ES	1	Total 32	10	5	14	3	0
107	EU	1	Total 32	10	5	14	3	0
107	EW	1	Total 32	10	5	14	3	0
107	EY	1	Total 32	10	5	14	3	0
107	FC	1	Total 32	10	5	14	3	0
107	FE	1	Total 32	10	5	14	3	0
107	FG	1	Total 32	10	5	14	3	0
107	FI	1	Total 32	10	5	14	3	0
107	FK	1	Total 32	10	5	14	3	0
107	FM	1	Total 32	10	5	14	3	0
107	FN	1	Total 32	10	5	14	3	0
107	FQ	1	Total 32	10	5	14	3	0
107	FS	1	Total 32	10	5	14	3	0
107	FU	1	Total 32	10	5	14	3	0
107	FW	1	Total 32	10	5	14	3	0

Continued on next page...

Continued from previous page...

Mol	Chain	Residues	Atoms					AltConf
			Total	C	N	O	P	
107	FY	1	32	10	5	14	3	0
107	GC	1	32	10	5	14	3	0
107	GE	1	32	10	5	14	3	0
107	GG	1	32	10	5	14	3	0
107	GI	1	32	10	5	14	3	0
107	GK	1	32	10	5	14	3	0
107	GM	1	32	10	5	14	3	0
107	GO	1	32	10	5	14	3	0
107	GQ	1	32	10	5	14	3	0
107	GR	1	32	10	5	14	3	0
107	GU	1	32	10	5	14	3	0
107	GW	1	32	10	5	14	3	0
107	GX	1	32	10	5	14	3	0
107	HA	1	32	10	5	14	3	0
107	HC	1	32	10	5	14	3	0
107	HE	1	32	10	5	14	3	0
107	HF	1	32	10	5	14	3	0
107	HI	1	32	10	5	14	3	0
107	HK	1	32	10	5	14	3	0
107	HM	1	32	10	5	14	3	0
107	HN	1	32	10	5	14	3	0

Continued on next page...

Continued from previous page...

Mol	Chain	Residues	Atoms					AltConf
			Total	C	N	O	P	
107	HQ	1	Total 32	10	5	14	3	0
107	HS	1	Total 32	10	5	14	3	0
107	HU	1	Total 32	10	5	14	3	0
107	HW	1	Total 32	10	5	14	3	0
107	HY	1	Total 32	10	5	14	3	0
107	IA	1	Total 32	10	5	14	3	0
107	IC	1	Total 32	10	5	14	3	0
107	ID	1	Total 32	10	5	14	3	0
107	IG	1	Total 32	10	5	14	3	0
107	II	1	Total 32	10	5	14	3	0
107	IK	1	Total 32	10	5	14	3	0
107	IM	1	Total 32	10	5	14	3	0
107	IO	1	Total 32	10	5	14	3	0
107	IQ	1	Total 32	10	5	14	3	0
107	IS	1	Total 32	10	5	14	3	0
107	IU	1	Total 32	10	5	14	3	0
107	IW	1	Total 32	10	5	14	3	0
107	IY	1	Total 32	10	5	14	3	0
107	JC	1	Total 32	10	5	14	3	0
107	JD	1	Total 32	10	5	14	3	0
107	JG	1	Total 32	10	5	14	3	0

Continued on next page...

Continued from previous page...

Mol	Chain	Residues	Atoms					AltConf
			Total	C	N	O	P	
107	JI	1	Total 32	C 10	N 5	O 14	P 3	0
107	JJ	1	Total 32	C 10	N 5	O 14	P 3	0
107	JM	1	Total 32	C 10	N 5	O 14	P 3	0
107	JO	1	Total 32	C 10	N 5	O 14	P 3	0
107	JQ	1	Total 32	C 10	N 5	O 14	P 3	0
107	JR	1	Total 32	C 10	N 5	O 14	P 3	0
107	JU	1	Total 32	C 10	N 5	O 14	P 3	0
107	JW	1	Total 32	C 10	N 5	O 14	P 3	0
107	JY	1	Total 32	C 10	N 5	O 14	P 3	0
107	KC	1	Total 32	C 10	N 5	O 14	P 3	0
107	KE	1	Total 32	C 10	N 5	O 14	P 3	0
107	KF	1	Total 32	C 10	N 5	O 14	P 3	0
107	KI	1	Total 32	C 10	N 5	O 14	P 3	0
107	KK	1	Total 32	C 10	N 5	O 14	P 3	0
107	KM	1	Total 32	C 10	N 5	O 14	P 3	0
107	KN	1	Total 32	C 10	N 5	O 14	P 3	0
107	KQ	1	Total 32	C 10	N 5	O 14	P 3	0
107	KS	1	Total 32	C 10	N 5	O 14	P 3	0
107	KU	1	Total 32	C 10	N 5	O 14	P 3	0
107	KW	1	Total 32	C 10	N 5	O 14	P 3	0
107	KY	1	Total 32	C 10	N 5	O 14	P 3	0

Continued on next page...

Continued from previous page...

Mol	Chain	Residues	Atoms					AltConf
			Total	C	N	O	P	
107	LC	1	Total 32	C 10	N 5	O 14	P 3	0
107	LE	1	Total 32	C 10	N 5	O 14	P 3	0
107	LG	1	Total 32	C 10	N 5	O 14	P 3	0
107	LI	1	Total 32	C 10	N 5	O 14	P 3	0
107	LK	1	Total 32	C 10	N 5	O 14	P 3	0
107	LM	1	Total 32	C 10	N 5	O 14	P 3	0
107	LO	1	Total 32	C 10	N 5	O 14	P 3	0
107	LQ	1	Total 32	C 10	N 5	O 14	P 3	0
107	LS	1	Total 32	C 10	N 5	O 14	P 3	0
107	LU	1	Total 32	C 10	N 5	O 14	P 3	0
107	LW	1	Total 32	C 10	N 5	O 14	P 3	0
107	LY	1	Total 32	C 10	N 5	O 14	P 3	0
107	MA	1	Total 32	C 10	N 5	O 14	P 3	0
107	MC	1	Total 32	C 10	N 5	O 14	P 3	0
107	ME	1	Total 32	C 10	N 5	O 14	P 3	0
107	MG	1	Total 32	C 10	N 5	O 14	P 3	0
107	MI	1	Total 32	C 10	N 5	O 14	P 3	0
107	MK	1	Total 32	C 10	N 5	O 14	P 3	0
107	MM	1	Total 32	C 10	N 5	O 14	P 3	0
107	MN	1	Total 32	C 10	N 5	O 14	P 3	0
107	MQ	1	Total 32	C 10	N 5	O 14	P 3	0

Continued on next page...

Continued from previous page...

Mol	Chain	Residues	Atoms					AltConf
			Total	C	N	O	P	
107	MS	1	Total 32	C 10	N 5	O 14	P 3	0
107	MT	1	Total 32	C 10	N 5	O 14	P 3	0
107	MW	1	Total 32	C 10	N 5	O 14	P 3	0
107	MY	1	Total 32	C 10	N 5	O 14	P 3	0
107	NA	1	Total 32	C 10	N 5	O 14	P 3	0
107	NC	1	Total 32	C 10	N 5	O 14	P 3	0
107	ND	1	Total 32	C 10	N 5	O 14	P 3	0
107	NG	1	Total 32	C 10	N 5	O 14	P 3	0
107	NI	1	Total 32	C 10	N 5	O 14	P 3	0
107	NK	1	Total 32	C 10	N 5	O 14	P 3	0
107	NL	1	Total 32	C 10	N 5	O 14	P 3	0
107	NO	1	Total 32	C 10	N 5	O 14	P 3	0
107	NQ	1	Total 32	C 10	N 5	O 14	P 3	0
107	NS	1	Total 32	C 10	N 5	O 14	P 3	0
107	NU	1	Total 32	C 10	N 5	O 14	P 3	0
107	NW	1	Total 32	C 10	N 5	O 14	P 3	0
107	OA	1	Total 32	C 10	N 5	O 14	P 3	0
107	OC	1	Total 32	C 10	N 5	O 14	P 3	0
107	OE	1	Total 32	C 10	N 5	O 14	P 3	0
107	OG	1	Total 32	C 10	N 5	O 14	P 3	0
107	OI	1	Total 32	C 10	N 5	O 14	P 3	0

Continued on next page...

Continued from previous page...

Mol	Chain	Residues	Atoms					AltConf
			Total	C	N	O	P	
107	OK	1	32	10	5	14	3	0
107	OM	1	32	10	5	14	3	0
107	OO	1	32	10	5	14	3	0
107	OQ	1	32	10	5	14	3	0
107	OS	1	32	10	5	14	3	0
107	OU	1	32	10	5	14	3	0
107	OW	1	32	10	5	14	3	0
107	OY	1	32	10	5	14	3	0
107	PA	1	32	10	5	14	3	0
107	PC	1	32	10	5	14	3	0
107	PE	1	32	10	5	14	3	0
107	PG	1	32	10	5	14	3	0
107	PI	1	32	10	5	14	3	0
107	PK	1	32	10	5	14	3	0
107	PM	1	32	10	5	14	3	0
107	PN	1	32	10	5	14	3	0
107	PQ	1	32	10	5	14	3	0
107	PS	1	32	10	5	14	3	0
107	PT	1	32	10	5	14	3	0
107	PW	1	32	10	5	14	3	0
107	PY	1	32	10	5	14	3	0

Continued on next page...

Continued from previous page...

Mol	Chain	Residues	Atoms					AltConf
			Total	C	N	O	P	
107	QA	1	Total 32	10	5	14	3	0
107	QC	1	Total 32	10	5	14	3	0
107	QD	1	Total 32	10	5	14	3	0
107	QG	1	Total 32	10	5	14	3	0
107	QI	1	Total 32	10	5	14	3	0
107	QK	1	Total 32	10	5	14	3	0
107	QL	1	Total 32	10	5	14	3	0
107	QO	1	Total 32	10	5	14	3	0
107	QQ	1	Total 32	10	5	14	3	0
107	QR	1	Total 32	10	5	14	3	0
107	QU	1	Total 32	10	5	14	3	0
107	QW	1	Total 32	10	5	14	3	0
107	QX	1	Total 32	10	5	14	3	0
107	RA	1	Total 32	10	5	14	3	0
107	RC	1	Total 32	10	5	14	3	0
107	RE	1	Total 32	10	5	14	3	0
107	RF	1	Total 32	10	5	14	3	0
107	RI	1	Total 32	10	5	14	3	0
107	RK	1	Total 32	10	5	14	3	0
107	RM	1	Total 32	10	5	14	3	0
107	RN	1	Total 32	10	5	14	3	0

Continued on next page...

Continued from previous page...

Mol	Chain	Residues	Atoms					AltConf
			Total	C	N	O	P	
107	RQ	1	Total 32	C 10	N 5	O 14	P 3	0
107	RS	1	Total 32	C 10	N 5	O 14	P 3	0
107	RT	1	Total 32	C 10	N 5	O 14	P 3	0
107	RW	1	Total 32	C 10	N 5	O 14	P 3	0
107	RY	1	Total 32	C 10	N 5	O 14	P 3	0
107	SC	1	Total 32	C 10	N 5	O 14	P 3	0
107	SE	1	Total 32	C 10	N 5	O 14	P 3	0
107	SG	1	Total 32	C 10	N 5	O 14	P 3	0
107	SI	1	Total 32	C 10	N 5	O 14	P 3	0
107	SK	1	Total 32	C 10	N 5	O 14	P 3	0
107	SL	1	Total 32	C 10	N 5	O 14	P 3	0
107	SO	1	Total 32	C 10	N 5	O 14	P 3	0
107	SQ	1	Total 32	C 10	N 5	O 14	P 3	0
107	SR	1	Total 32	C 10	N 5	O 14	P 3	0
107	SU	1	Total 32	C 10	N 5	O 14	P 3	0
107	SW	1	Total 32	C 10	N 5	O 14	P 3	0
107	SX	1	Total 32	C 10	N 5	O 14	P 3	0
107	TB	1	Total 32	C 10	N 5	O 14	P 3	0
107	TE	1	Total 32	C 10	N 5	O 14	P 3	0
107	TG	1	Total 32	C 10	N 5	O 14	P 3	0
107	TI	1	Total 32	C 10	N 5	O 14	P 3	0

Continued on next page...

Continued from previous page...

Mol	Chain	Residues	Atoms					AltConf
			Total	C	N	O	P	
107	TK	1	Total 32	C 10	N 5	O 14	P 3	0
107	TM	1	Total 32	C 10	N 5	O 14	P 3	0
107	TN	1	Total 32	C 10	N 5	O 14	P 3	0
107	TQ	1	Total 32	C 10	N 5	O 14	P 3	0
107	TS	1	Total 32	C 10	N 5	O 14	P 3	0
107	TU	1	Total 32	C 10	N 5	O 14	P 3	0
107	TW	1	Total 32	C 10	N 5	O 14	P 3	0
107	TY	1	Total 32	C 10	N 5	O 14	P 3	0
107	UC	1	Total 32	C 10	N 5	O 14	P 3	0
107	UE	1	Total 32	C 10	N 5	O 14	P 3	0
107	UG	1	Total 32	C 10	N 5	O 14	P 3	0
107	UI	1	Total 32	C 10	N 5	O 14	P 3	0
107	UK	1	Total 32	C 10	N 5	O 14	P 3	0
107	UM	1	Total 32	C 10	N 5	O 14	P 3	0
107	UO	1	Total 32	C 10	N 5	O 14	P 3	0
107	UQ	1	Total 32	C 10	N 5	O 14	P 3	0
107	US	1	Total 32	C 10	N 5	O 14	P 3	0
107	UU	1	Total 32	C 10	N 5	O 14	P 3	0
107	UW	1	Total 32	C 10	N 5	O 14	P 3	0
107	UY	1	Total 32	C 10	N 5	O 14	P 3	0
107	VC	1	Total 32	C 10	N 5	O 14	P 3	0

Continued on next page...

Continued from previous page...

Mol	Chain	Residues	Atoms					AltConf
			Total	C	N	O	P	
107	VE	1	32	10	5	14	3	0
107	VG	1	32	10	5	14	3	0
107	VI	1	32	10	5	14	3	0
107	VK	1	32	10	5	14	3	0
107	VM	1	32	10	5	14	3	0
107	VN	1	32	10	5	14	3	0
107	VQ	1	32	10	5	14	3	0
107	VS	1	32	10	5	14	3	0
107	VU	1	32	10	5	14	3	0
107	VW	1	32	10	5	14	3	0
107	VY	1	32	10	5	14	3	0
107	WA	1	32	10	5	14	3	0
107	WC	1	32	10	5	14	3	0
107	WE	1	32	10	5	14	3	0
107	WG	1	32	10	5	14	3	0
107	WI	1	32	10	5	14	3	0
107	WK	1	32	10	5	14	3	0
107	WM	1	32	10	5	14	3	0
107	WO	1	32	10	5	14	3	0
107	WQ	1	32	10	5	14	3	0
107	WS	1	32	10	5	14	3	0

Continued on next page...

Continued from previous page...

Mol	Chain	Residues	Atoms					AltConf
			Total	C	N	O	P	
107	WU	1	32	10	5	14	3	0
107	WW	1	32	10	5	14	3	0

- Molecule 108 is MAGNESIUM ION (three-letter code: MG) (formula: Mg).

Mol	Chain	Residues	Atoms		AltConf
108	AZ	1	Total	Mg	0
			1	1	
108	AC	1	Total	Mg	0
			1	1	
108	AE	1	Total	Mg	0
			1	1	
108	AG	1	Total	Mg	0
			1	1	
108	AI	1	Total	Mg	0
			1	1	
108	AK	1	Total	Mg	0
			1	1	
108	AM	1	Total	Mg	0
			1	1	
108	AO	1	Total	Mg	0
			1	1	
108	AQ	1	Total	Mg	0
			1	1	
108	AS	1	Total	Mg	0
			1	1	
108	AU	1	Total	Mg	0
			1	1	
108	AW	1	Total	Mg	0
			1	1	
108	AY	1	Total	Mg	0
			1	1	
108	BA	1	Total	Mg	0
			1	1	
108	BC	1	Total	Mg	0
			1	1	
108	BE	1	Total	Mg	0
			1	1	
108	BG	1	Total	Mg	0
			1	1	

Continued on next page...

Continued from previous page...

Mol	Chain	Residues	Atoms		AltConf
			Total	Mg	
108	BI	1	1	1	0
108	BK	1	1	1	0
108	BM	1	1	1	0
108	BO	1	1	1	0
108	BP	1	1	1	0
108	BS	1	1	1	0
108	BU	1	1	1	0
108	BW	1	1	1	0
108	BY	1	1	1	0
108	CC	1	1	1	0
108	CE	1	1	1	0
108	CG	1	1	1	0
108	CI	1	1	1	0
108	CK	1	1	1	0
108	CM	1	1	1	0
108	CO	1	1	1	0
108	CQ	1	1	1	0
108	CS	1	1	1	0
108	CU	1	1	1	0
108	CW	1	1	1	0
108	CY	1	1	1	0

Continued on next page...

Continued from previous page...

Mol	Chain	Residues	Atoms		AltConf
			Total	Mg	
108	DC	1	1	1	0
108	DE	1	1	1	0
108	DG	1	1	1	0
108	DI	1	1	1	0
108	DK	1	1	1	0
108	DM	1	1	1	0
108	DO	1	1	1	0
108	DQ	1	1	1	0
108	DS	1	1	1	0
108	DU	1	1	1	0
108	DW	1	1	1	0
108	DY	1	1	1	0
108	EC	1	1	1	0
108	EE	1	1	1	0
108	EG	1	1	1	0
108	EI	1	1	1	0
108	EK	1	1	1	0
108	EM	1	1	1	0
108	EO	1	1	1	0
108	EQ	1	1	1	0
108	ES	1	1	1	0

Continued on next page...

Continued from previous page...

Mol	Chain	Residues	Atoms		AltConf
			Total	Mg	
108	EU	1	1	1	0
108	EW	1	1	1	0
108	EY	1	1	1	0
108	FB	1	1	1	0
108	FE	1	1	1	0
108	FG	1	1	1	0
108	FH	1	1	1	0
108	FK	1	1	1	0
108	FM	1	1	1	0
108	FO	1	1	1	0
108	FQ	1	1	1	0
108	FS	1	1	1	0
108	FU	1	1	1	0
108	FV	1	1	1	0
108	FY	1	1	1	0
108	GC	1	1	1	0
108	GE	1	1	1	0
108	GG	1	1	1	0
108	GI	1	1	1	0
108	GK	1	1	1	0
108	GM	1	1	1	0

Continued on next page...

Continued from previous page...

Mol	Chain	Residues	Atoms		AltConf
			Total	Mg	
108	GO	1	1	1	0
108	GQ	1	1	1	0
108	GS	1	1	1	0
108	GU	1	1	1	0
108	GW	1	1	1	0
108	GY	1	1	1	0
108	HA	1	1	1	0
108	HC	1	1	1	0
108	HE	1	1	1	0
108	HG	1	1	1	0
108	HH	1	1	1	0
108	HK	1	1	1	0
108	HM	1	1	1	0
108	HO	1	1	1	0
108	HQ	1	1	1	0
108	HS	1	1	1	0
108	HU	1	1	1	0
108	HV	1	1	1	0
108	HY	1	1	1	0
108	IA	1	1	1	0
108	IC	1	1	1	0

Continued on next page...

Continued from previous page...

Mol	Chain	Residues	Atoms		AltConf
			Total	Mg	
108	IE	1	1	1	0
108	IG	1	1	1	0
108	II	1	1	1	0
108	IK	1	1	1	0
108	IM	1	1	1	0
108	IO	1	1	1	0
108	IQ	1	1	1	0
108	IS	1	1	1	0
108	IU	1	1	1	0
108	IW	1	1	1	0
108	IY	1	1	1	0
108	JC	1	1	1	0
108	JE	1	1	1	0
108	JG	1	1	1	0
108	JI	1	1	1	0
108	JK	1	1	1	0
108	JM	1	1	1	0
108	JO	1	1	1	0
108	JQ	1	1	1	0
108	JS	1	1	1	0
108	JU	1	1	1	0

Continued on next page...

Continued from previous page...

Mol	Chain	Residues	Atoms		AltConf
			Total	Mg	
108	JW	1	1	1	0
108	JY	1	1	1	0
108	KC	1	1	1	0
108	KE	1	1	1	0
108	KG	1	1	1	0
108	KH	1	1	1	0
108	KK	1	1	1	0
108	KM	1	1	1	0
108	KO	1	1	1	0
108	KQ	1	1	1	0
108	KS	1	1	1	0
108	KU	1	1	1	0
108	KV	1	1	1	0
108	KY	1	1	1	0
108	LC	1	1	1	0
108	LE	1	1	1	0
108	LG	1	1	1	0
108	LI	1	1	1	0
108	LK	1	1	1	0
108	LM	1	1	1	0
108	LO	1	1	1	0

Continued on next page...

Continued from previous page...

Mol	Chain	Residues	Atoms		AltConf
			Total	Mg	
108	LQ	1	1	1	0
108	LS	1	1	1	0
108	LU	1	1	1	0
108	LW	1	1	1	0
108	LY	1	1	1	0
108	MA	1	1	1	0
108	MC	1	1	1	0
108	ME	1	1	1	0
108	MG	1	1	1	0
108	MH	1	1	1	0
108	MK	1	1	1	0
108	MM	1	1	1	0
108	MO	1	1	1	0
108	MQ	1	1	1	0
108	MS	1	1	1	0
108	MU	1	1	1	0
108	MV	1	1	1	0
108	MY	1	1	1	0
108	NA	1	1	1	0
108	NC	1	1	1	0
108	NE	1	1	1	0

Continued on next page...

Continued from previous page...

Mol	Chain	Residues	Atoms		AltConf
			Total	Mg	
108	NG	1	1	1	0
108	NI	1	1	1	0
108	NK	1	1	1	0
108	NM	1	1	1	0
108	NO	1	1	1	0
108	NQ	1	1	1	0
108	NS	1	1	1	0
108	NU	1	1	1	0
108	NW	1	1	1	0
108	OA	1	1	1	0
108	OC	1	1	1	0
108	OE	1	1	1	0
108	OG	1	1	1	0
108	OI	1	1	1	0
108	OK	1	1	1	0
108	OM	1	1	1	0
108	OO	1	1	1	0
108	OQ	1	1	1	0
108	OS	1	1	1	0
108	OU	1	1	1	0
108	OW	1	1	1	0

Continued on next page...

Continued from previous page...

Mol	Chain	Residues	Atoms		AltConf
			Total	Mg	
108	OY	1	1	1	0
108	PA	1	1	1	0
108	PC	1	1	1	0
108	PE	1	1	1	0
108	PG	1	1	1	0
108	PI	1	1	1	0
108	PK	1	1	1	0
108	PM	1	1	1	0
108	PO	1	1	1	0
108	PQ	1	1	1	0
108	PS	1	1	1	0
108	PU	1	1	1	0
108	PV	1	1	1	0
108	PY	1	1	1	0
108	QA	1	1	1	0
108	QC	1	1	1	0
108	QE	1	1	1	0
108	QG	1	1	1	0
108	QI	1	1	1	0
108	QK	1	1	1	0
108	QM	1	1	1	0

Continued on next page...

Continued from previous page...

Mol	Chain	Residues	Atoms		AltConf
			Total	Mg	
108	QO	1	1	1	0
108	QQ	1	1	1	0
108	QS	1	1	1	0
108	QU	1	1	1	0
108	QW	1	1	1	0
108	QY	1	1	1	0
108	RA	1	1	1	0
108	RC	1	1	1	0
108	RE	1	1	1	0
108	RG	1	1	1	0
108	RH	1	1	1	0
108	RK	1	1	1	0
108	RM	1	1	1	0
108	RO	1	1	1	0
108	RQ	1	1	1	0
108	RS	1	1	1	0
108	RT	1	1	1	0
108	RV	1	1	1	0
108	RY	1	1	1	0
108	SC	1	1	1	0
108	SE	1	1	1	0

Continued on next page...

Continued from previous page...

Mol	Chain	Residues	Atoms		AltConf
			Total	Mg	
108	SG	1	1	1	0
108	SI	1	1	1	0
108	SK	1	1	1	0
108	SM	1	1	1	0
108	SO	1	1	1	0
108	SQ	1	1	1	0
108	SS	1	1	1	0
108	SU	1	1	1	0
108	SW	1	1	1	0
108	SY	1	1	1	0
108	TB	1	1	1	0
108	TE	1	1	1	0
108	TG	1	1	1	0
108	TI	1	1	1	0
108	TK	1	1	1	0
108	TM	1	1	1	0
108	TO	1	1	1	0
108	TQ	1	1	1	0
108	TS	1	1	1	0
108	TU	1	1	1	0
108	TW	1	1	1	0

Continued on next page...

Continued from previous page...

Mol	Chain	Residues	Atoms		AltConf
			Total	Mg	
108	TY	1	1	1	0
108	UC	1	1	1	0
108	UE	1	1	1	0
108	UG	1	1	1	0
108	UI	1	1	1	0
108	UK	1	1	1	0
108	UM	1	1	1	0
108	UO	1	1	1	0
108	UQ	1	1	1	0
108	US	1	1	1	0
108	UU	1	1	1	0
108	UW	1	1	1	0
108	UY	1	1	1	0
108	VC	1	1	1	0
108	VE	1	1	1	0
108	VG	1	1	1	0
108	VH	1	1	1	0
108	VK	1	1	1	0
108	VM	1	1	1	0
108	VO	1	1	1	0
108	VQ	1	1	1	0

Continued on next page...

Continued from previous page...

Mol	Chain	Residues	Atoms		AltConf
			Total	Mg	
108	VS	1	1	1	0
108	VU	1	1	1	0
108	VV	1	1	1	0
108	VY	1	1	1	0
108	WA	1	1	1	0
108	WC	1	1	1	0
108	WE	1	1	1	0
108	WG	1	1	1	0
108	WI	1	1	1	0
108	WK	1	1	1	0
108	WM	1	1	1	0
108	WO	1	1	1	0
108	WQ	1	1	1	0
108	WS	1	1	1	0
108	WU	1	1	1	0
108	WW	1	1	1	0

- Molecule 109 is GUANOSINE-5'-DIPHOSPHATE (three-letter code: GDP) (formula: $C_{10}H_{15}N_5O_{11}P_2$).

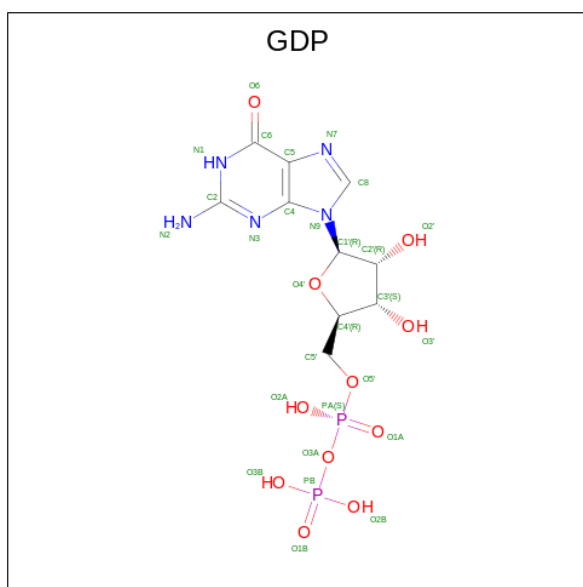

Mol	Chain	Residues	Atoms					AltConf
			Total	C	N	O	P	
109	AB	1	Total	C	N	O	P	0
			28	10	5	11	2	
109	AD	1	Total	C	N	O	P	0
			28	10	5	11	2	
109	AF	1	Total	C	N	O	P	0
			28	10	5	11	2	
109	AH	1	Total	C	N	O	P	0
			28	10	5	11	2	
109	AJ	1	Total	C	N	O	P	0
			28	10	5	11	2	
109	AL	1	Total	C	N	O	P	0
			28	10	5	11	2	
109	AN	1	Total	C	N	O	P	0
			28	10	5	11	2	
109	AP	1	Total	C	N	O	P	0
			28	10	5	11	2	
109	AR	1	Total	C	N	O	P	0
			28	10	5	11	2	
109	AT	1	Total	C	N	O	P	0
			28	10	5	11	2	
109	AV	1	Total	C	N	O	P	0
			28	10	5	11	2	
109	AX	1	Total	C	N	O	P	0
			28	10	5	11	2	
109	BB	1	Total	C	N	O	P	0
			28	10	5	11	2	
109	BD	1	Total	C	N	O	P	0
			28	10	5	11	2	

Continued on next page...

Continued from previous page...

Mol	Chain	Residues	Atoms					AltConf
			Total	C	N	O	P	
109	BF	1	Total 28	C 10	N 5	O 11	P 2	0
109	BH	1	Total 28	C 10	N 5	O 11	P 2	0
109	BJ	1	Total 28	C 10	N 5	O 11	P 2	0
109	BL	1	Total 28	C 10	N 5	O 11	P 2	0
109	BN	1	Total 28	C 10	N 5	O 11	P 2	0
109	BP	1	Total 28	C 10	N 5	O 11	P 2	0
109	BR	1	Total 28	C 10	N 5	O 11	P 2	0
109	BT	1	Total 28	C 10	N 5	O 11	P 2	0
109	BV	1	Total 28	C 10	N 5	O 11	P 2	0
109	BX	1	Total 28	C 10	N 5	O 11	P 2	0
109	CB	1	Total 28	C 10	N 5	O 11	P 2	0
109	CD	1	Total 28	C 10	N 5	O 11	P 2	0
109	CF	1	Total 28	C 10	N 5	O 11	P 2	0
109	CH	1	Total 28	C 10	N 5	O 11	P 2	0
109	CJ	1	Total 28	C 10	N 5	O 11	P 2	0
109	CL	1	Total 28	C 10	N 5	O 11	P 2	0
109	CN	1	Total 28	C 10	N 5	O 11	P 2	0
109	CP	1	Total 28	C 10	N 5	O 11	P 2	0
109	CR	1	Total 28	C 10	N 5	O 11	P 2	0
109	CT	1	Total 28	C 10	N 5	O 11	P 2	0
109	CV	1	Total 28	C 10	N 5	O 11	P 2	0

Continued on next page...

Continued from previous page...

Mol	Chain	Residues	Atoms					AltConf
			Total	C	N	O	P	
109	CX	1	28	10	5	11	2	0
109	CZ	1	28	10	5	11	2	0
109	DB	1	28	10	5	11	2	0
109	DD	1	28	10	5	11	2	0
109	DF	1	28	10	5	11	2	0
109	DH	1	28	10	5	11	2	0
109	DJ	1	28	10	5	11	2	0
109	DL	1	28	10	5	11	2	0
109	DN	1	28	10	5	11	2	0
109	DP	1	28	10	5	11	2	0
109	DR	1	28	10	5	11	2	0
109	DT	1	28	10	5	11	2	0
109	DV	1	28	10	5	11	2	0
109	DX	1	28	10	5	11	2	0
109	DZ	1	28	10	5	11	2	0
109	EB	1	28	10	5	11	2	0
109	ED	1	28	10	5	11	2	0
109	EF	1	28	10	5	11	2	0
109	EH	1	28	10	5	11	2	0
109	EJ	1	28	10	5	11	2	0
109	EL	1	28	10	5	11	2	0

Continued on next page...

Continued from previous page...

Mol	Chain	Residues	Atoms					AltConf
			Total	C	N	O	P	
109	EN	1	28	10	5	11	2	0
109	EP	1	28	10	5	11	2	0
109	ER	1	28	10	5	11	2	0
109	ET	1	28	10	5	11	2	0
109	EV	1	28	10	5	11	2	0
109	EX	1	28	10	5	11	2	0
109	EZ	1	28	10	5	11	2	0
109	FB	1	28	10	5	11	2	0
109	FD	1	28	10	5	11	2	0
109	FF	1	28	10	5	11	2	0
109	FH	1	28	10	5	11	2	0
109	FJ	1	28	10	5	11	2	0
109	FL	1	28	10	5	11	2	0
109	FN	1	28	10	5	11	2	0
109	FP	1	28	10	5	11	2	0
109	FR	1	28	10	5	11	2	0
109	FT	1	28	10	5	11	2	0
109	FV	1	28	10	5	11	2	0
109	FX	1	28	10	5	11	2	0
109	FZ	1	28	10	5	11	2	0
109	GB	1	28	10	5	11	2	0

Continued on next page...

Continued from previous page...

Mol	Chain	Residues	Atoms					AltConf
			Total	C	N	O	P	
109	GD	1	28	10	5	11	2	0
109	GF	1	28	10	5	11	2	0
109	GH	1	28	10	5	11	2	0
109	GJ	1	28	10	5	11	2	0
109	GL	1	28	10	5	11	2	0
109	GN	1	28	10	5	11	2	0
109	GP	1	28	10	5	11	2	0
109	GR	1	28	10	5	11	2	0
109	GT	1	28	10	5	11	2	0
109	GV	1	28	10	5	11	2	0
109	GX	1	28	10	5	11	2	0
109	GZ	1	28	10	5	11	2	0
109	HB	1	28	10	5	11	2	0
109	HD	1	28	10	5	11	2	0
109	HF	1	28	10	5	11	2	0
109	HH	1	28	10	5	11	2	0
109	HJ	1	28	10	5	11	2	0
109	HL	1	28	10	5	11	2	0
109	HN	1	28	10	5	11	2	0
109	HP	1	28	10	5	11	2	0
109	HR	1	28	10	5	11	2	0

Continued on next page...

Continued from previous page...

Mol	Chain	Residues	Atoms					AltConf
			Total	C	N	O	P	
109	HT	1	Total 28	C 10	N 5	O 11	P 2	0
109	HV	1	Total 28	C 10	N 5	O 11	P 2	0
109	HX	1	Total 28	C 10	N 5	O 11	P 2	0
109	HZ	1	Total 28	C 10	N 5	O 11	P 2	0
109	IB	1	Total 28	C 10	N 5	O 11	P 2	0
109	ID	1	Total 28	C 10	N 5	O 11	P 2	0
109	IF	1	Total 28	C 10	N 5	O 11	P 2	0
109	IH	1	Total 28	C 10	N 5	O 11	P 2	0
109	IJ	1	Total 28	C 10	N 5	O 11	P 2	0
109	IL	1	Total 28	C 10	N 5	O 11	P 2	0
109	IN	1	Total 28	C 10	N 5	O 11	P 2	0
109	IP	1	Total 28	C 10	N 5	O 11	P 2	0
109	IR	1	Total 28	C 10	N 5	O 11	P 2	0
109	IT	1	Total 28	C 10	N 5	O 11	P 2	0
109	IV	1	Total 28	C 10	N 5	O 11	P 2	0
109	IX	1	Total 28	C 10	N 5	O 11	P 2	0
109	JB	1	Total 28	C 10	N 5	O 11	P 2	0
109	JD	1	Total 28	C 10	N 5	O 11	P 2	0
109	JF	1	Total 28	C 10	N 5	O 11	P 2	0
109	JH	1	Total 28	C 10	N 5	O 11	P 2	0
109	JJ	1	Total 28	C 10	N 5	O 11	P 2	0

Continued on next page...

Continued from previous page...

Mol	Chain	Residues	Atoms					AltConf
			Total	C	N	O	P	
109	JL	1	28	10	5	11	2	0
109	JN	1	28	10	5	11	2	0
109	JP	1	28	10	5	11	2	0
109	JR	1	28	10	5	11	2	0
109	JT	1	28	10	5	11	2	0
109	JV	1	28	10	5	11	2	0
109	JX	1	28	10	5	11	2	0
109	JZ	1	28	10	5	11	2	0
109	KB	1	28	10	5	11	2	0
109	KD	1	28	10	5	11	2	0
109	KF	1	28	10	5	11	2	0
109	KH	1	28	10	5	11	2	0
109	KJ	1	28	10	5	11	2	0
109	KL	1	28	10	5	11	2	0
109	KN	1	28	10	5	11	2	0
109	KP	1	28	10	5	11	2	0
109	KR	1	28	10	5	11	2	0
109	KT	1	28	10	5	11	2	0
109	KV	1	28	10	5	11	2	0
109	KX	1	28	10	5	11	2	0
109	KZ	1	28	10	5	11	2	0

Continued on next page...

Continued from previous page...

Mol	Chain	Residues	Atoms					AltConf
			Total	C	N	O	P	
109	LB	1	Total 28	C 10	N 5	O 11	P 2	0
109	LD	1	Total 28	C 10	N 5	O 11	P 2	0
109	LF	1	Total 28	C 10	N 5	O 11	P 2	0
109	LH	1	Total 28	C 10	N 5	O 11	P 2	0
109	LJ	1	Total 28	C 10	N 5	O 11	P 2	0
109	LL	1	Total 28	C 10	N 5	O 11	P 2	0
109	LN	1	Total 28	C 10	N 5	O 11	P 2	0
109	LP	1	Total 28	C 10	N 5	O 11	P 2	0
109	LR	1	Total 28	C 10	N 5	O 11	P 2	0
109	LT	1	Total 28	C 10	N 5	O 11	P 2	0
109	LV	1	Total 28	C 10	N 5	O 11	P 2	0
109	LX	1	Total 28	C 10	N 5	O 11	P 2	0
109	LZ	1	Total 28	C 10	N 5	O 11	P 2	0
109	MD	1	Total 28	C 10	N 5	O 11	P 2	0
109	MF	1	Total 28	C 10	N 5	O 11	P 2	0
109	MH	1	Total 28	C 10	N 5	O 11	P 2	0
109	MJ	1	Total 28	C 10	N 5	O 11	P 2	0
109	ML	1	Total 28	C 10	N 5	O 11	P 2	0
109	MN	1	Total 28	C 10	N 5	O 11	P 2	0
109	MP	1	Total 28	C 10	N 5	O 11	P 2	0
109	MR	1	Total 28	C 10	N 5	O 11	P 2	0

Continued on next page...

Continued from previous page...

Mol	Chain	Residues	Atoms					AltConf
			Total	C	N	O	P	
109	MT	1	28	10	5	11	2	0
109	MV	1	28	10	5	11	2	0
109	MX	1	28	10	5	11	2	0
109	MZ	1	28	10	5	11	2	0
109	NB	1	28	10	5	11	2	0
109	ND	1	28	10	5	11	2	0
109	NF	1	28	10	5	11	2	0
109	NH	1	28	10	5	11	2	0
109	NJ	1	28	10	5	11	2	0
109	NL	1	28	10	5	11	2	0
109	NN	1	28	10	5	11	2	0
109	NP	1	28	10	5	11	2	0
109	NR	1	28	10	5	11	2	0
109	NT	1	28	10	5	11	2	0
109	NV	1	28	10	5	11	2	0
109	NX	1	28	10	5	11	2	0
109	NZ	1	28	10	5	11	2	0
109	OB	1	28	10	5	11	2	0
109	OD	1	28	10	5	11	2	0
109	OF	1	28	10	5	11	2	0
109	OH	1	28	10	5	11	2	0

Continued on next page...

Continued from previous page...

Mol	Chain	Residues	Atoms					AltConf
			Total	C	N	O	P	
109	OJ	1	28	10	5	11	2	0
109	OL	1	28	10	5	11	2	0
109	ON	1	28	10	5	11	2	0
109	OP	1	28	10	5	11	2	0
109	OR	1	28	10	5	11	2	0
109	OT	1	28	10	5	11	2	0
109	OV	1	28	10	5	11	2	0
109	OX	1	28	10	5	11	2	0
109	PB	1	28	10	5	11	2	0
109	PD	1	28	10	5	11	2	0
109	PF	1	28	10	5	11	2	0
109	PH	1	28	10	5	11	2	0
109	PJ	1	28	10	5	11	2	0
109	PL	1	28	10	5	11	2	0
109	PN	1	28	10	5	11	2	0
109	PP	1	28	10	5	11	2	0
109	PR	1	28	10	5	11	2	0
109	PT	1	28	10	5	11	2	0
109	PV	1	28	10	5	11	2	0
109	PX	1	28	10	5	11	2	0
109	QB	1	28	10	5	11	2	0

Continued on next page...

Continued from previous page...

Mol	Chain	Residues	Atoms					AltConf
			Total	C	N	O	P	
109	QD	1	28	10	5	11	2	0
109	QF	1	28	10	5	11	2	0
109	QH	1	28	10	5	11	2	0
109	QJ	1	28	10	5	11	2	0
109	QL	1	28	10	5	11	2	0
109	QN	1	28	10	5	11	2	0
109	QP	1	28	10	5	11	2	0
109	QR	1	28	10	5	11	2	0
109	QT	1	28	10	5	11	2	0
109	QV	1	28	10	5	11	2	0
109	QX	1	28	10	5	11	2	0
109	RB	1	28	10	5	11	2	0
109	RD	1	28	10	5	11	2	0
109	RF	1	28	10	5	11	2	0
109	RH	1	28	10	5	11	2	0
109	RJ	1	28	10	5	11	2	0
109	RL	1	28	10	5	11	2	0
109	RN	1	28	10	5	11	2	0
109	RP	1	28	10	5	11	2	0
109	RR	1	28	10	5	11	2	0
109	RT	1	28	10	5	11	2	0

Continued on next page...

Continued from previous page...

Mol	Chain	Residues	Atoms					AltConf
			Total	C	N	O	P	
109	RV	1	28	10	5	11	2	0
109	RX	1	28	10	5	11	2	0
109	SB	1	28	10	5	11	2	0
109	SD	1	28	10	5	11	2	0
109	SF	1	28	10	5	11	2	0
109	SH	1	28	10	5	11	2	0
109	SJ	1	28	10	5	11	2	0
109	SL	1	28	10	5	11	2	0
109	SN	1	28	10	5	11	2	0
109	SP	1	28	10	5	11	2	0
109	SR	1	28	10	5	11	2	0
109	ST	1	28	10	5	11	2	0
109	SV	1	28	10	5	11	2	0
109	SX	1	28	10	5	11	2	0
109	TB	1	28	10	5	11	2	0
109	TD	1	28	10	5	11	2	0
109	TF	1	28	10	5	11	2	0
109	TH	1	28	10	5	11	2	0
109	TJ	1	28	10	5	11	2	0
109	TL	1	28	10	5	11	2	0
109	TN	1	28	10	5	11	2	0

Continued on next page...

Continued from previous page...

Mol	Chain	Residues	Atoms					AltConf
			Total	C	N	O	P	
109	TP	1	28	10	5	11	2	0
109	TR	1	28	10	5	11	2	0
109	TT	1	28	10	5	11	2	0
109	TV	1	28	10	5	11	2	0
109	TX	1	28	10	5	11	2	0
109	TZ	1	28	10	5	11	2	0
109	UB	1	28	10	5	11	2	0
109	UD	1	28	10	5	11	2	0
109	UF	1	28	10	5	11	2	0
109	UH	1	28	10	5	11	2	0
109	UJ	1	28	10	5	11	2	0
109	UL	1	28	10	5	11	2	0
109	UN	1	28	10	5	11	2	0
109	UP	1	28	10	5	11	2	0
109	UR	1	28	10	5	11	2	0
109	UT	1	28	10	5	11	2	0
109	UV	1	28	10	5	11	2	0
109	UX	1	28	10	5	11	2	0
109	UZ	1	28	10	5	11	2	0
109	VB	1	28	10	5	11	2	0
109	VD	1	28	10	5	11	2	0

Continued on next page...

Continued from previous page...

Mol	Chain	Residues	Atoms					AltConf
			Total	C	N	O	P	
109	VF	1	28	10	5	11	2	0
109	VH	1	28	10	5	11	2	0
109	VJ	1	28	10	5	11	2	0
109	VL	1	28	10	5	11	2	0
109	VN	1	28	10	5	11	2	0
109	VP	1	28	10	5	11	2	0
109	VR	1	28	10	5	11	2	0
109	VT	1	28	10	5	11	2	0
109	VV	1	28	10	5	11	2	0
109	VX	1	28	10	5	11	2	0
109	VZ	1	28	10	5	11	2	0
109	WB	1	28	10	5	11	2	0
109	WD	1	28	10	5	11	2	0
109	WF	1	28	10	5	11	2	0
109	WH	1	28	10	5	11	2	0
109	WJ	1	28	10	5	11	2	0
109	WL	1	28	10	5	11	2	0
109	WN	1	28	10	5	11	2	0
109	WP	1	28	10	5	11	2	0
109	WR	1	28	10	5	11	2	0
109	WT	1	28	10	5	11	2	0

Continued on next page...

Continued from previous page...

Mol	Chain	Residues	Atoms					AltConf
			Total	C	N	O	P	
109	WV	1	28	10	5	11	2	0
109	WX	1	28	10	5	11	2	0

3 Residue-property plots [i](#)

These plots are drawn for all protein, RNA, DNA and oligosaccharide chains in the entry. The first graphic for a chain summarises the proportions of the various outlier classes displayed in the second graphic. The second graphic shows the sequence view annotated by issues in geometry and atom inclusion in map density. Residues are color-coded according to the number of geometric quality criteria for which they contain at least one outlier: green = 0, yellow = 1, orange = 2 and red = 3 or more. A red diamond above a residue indicates a poor fit to the EM map for this residue (all-atom inclusion < 40%). Stretches of 2 or more consecutive residues without any outlier are shown as a green connector. Residues present in the sample, but not in the model, are shown in grey.

- Molecule 1: Dynein regulatory complex subunit 4

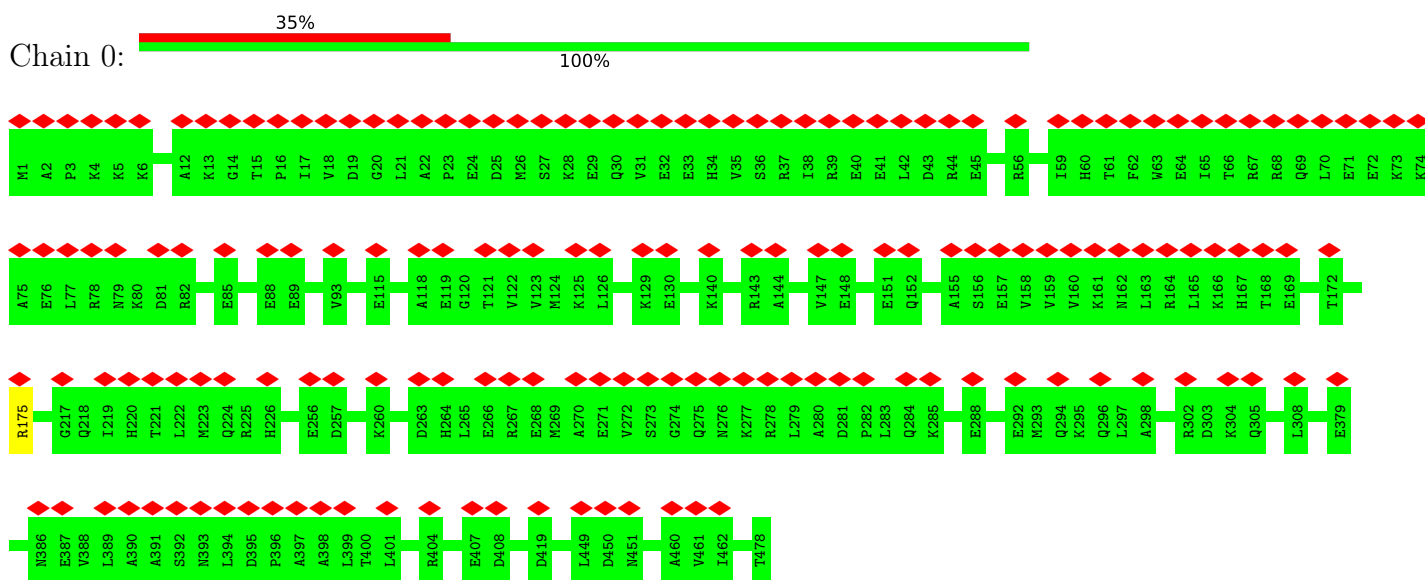

- Molecule 1: Dynein regulatory complex subunit 4

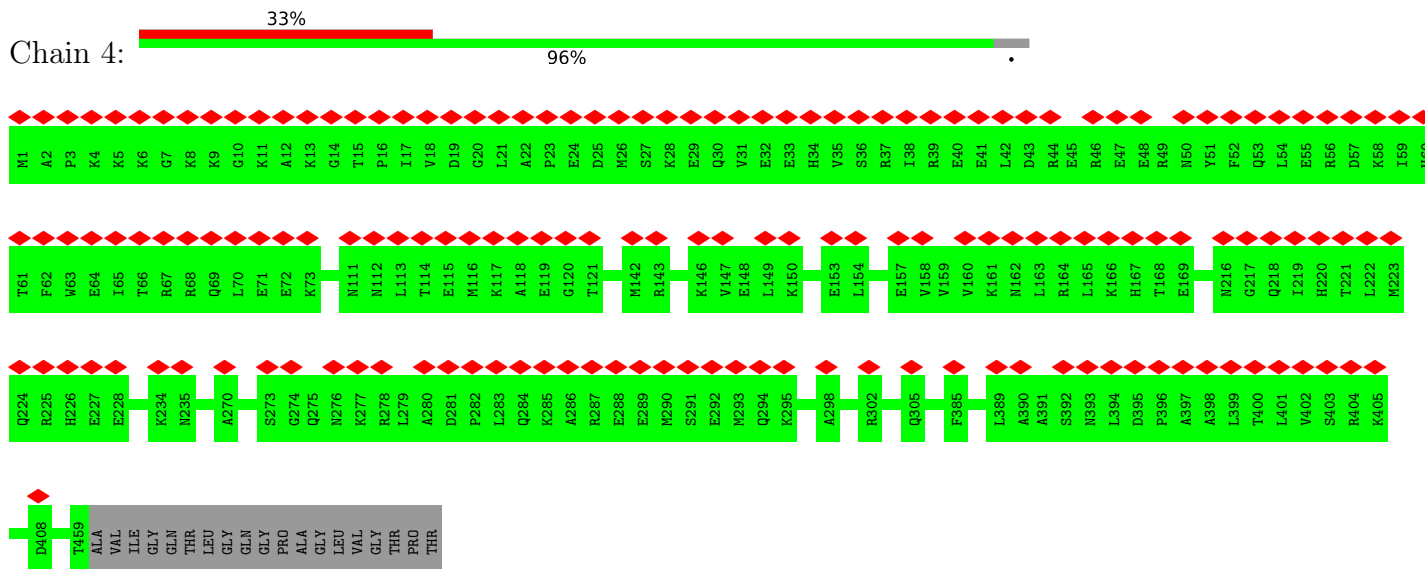

- Molecule 2: Dynein regulatory complex protein 1

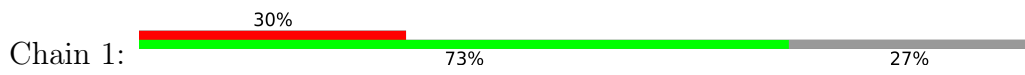

MET	ASN	PRO	PRO	GLY	GLY	LEU	GLU	ALA	GLU	ASP	PRO	ASN	VAL	ASP	GLN	ASP	GLU	HIS	LEU	LEU	SER	THR	GLN	ILE	LEU	ALA	PRO	SER	VAL	HIS	SER	ASP	ASN	SER	GLN	GLU	ARG	ARG	LEU	ILE	ALA	ALA	ARG	ARG	GLU	ALA	ALA	ARG	GLU	LEU	GLY	GLU	TYR	LEU	ASP		
GLY	LYS	GLU	SER	GLU	GLU	ASP	GLN	GLN	SER	SER	PRO	TYR	LYS	K76	E77	E78	S79	R80	L81	K82	L83	A84	K85	L86	L87	L88	C89	G90	T91	E92	L93	V94	T95	N96	I97	Q98	V99	A100	I101	D102	I103	R104	E105	I106	H107	R108	R109	V110	E111	E112	E113	E114	R117	Q118	R119	I120	E121
E124	N125	E126	V127	K128	T129	S130	Q131	D132	K133	F134	D135	E136	S139	K140	V141	E142	E143	Q146	K147	R148	I149	P150	Q151	E152	L153	W154	E155	M156	L157	N158	T159	Q160	Q161	H163	C164	A165	G166	L167	L168	E169	Q188	K191	D192	L193	K194	K195	Q196	S197	D198	I199	I200	C201					
L203	L204	E205	R206	M207	E208	E209	Q210	L211	K212	N213	V214	M215	K216	T217	F218	R219	E220	E221	L222	Y223	M224	L225	E226	K227	A228	F229	E230	V231	E232	R233	Q234	E235	L236	L237	A238	S239	M240	K241	K242	K243	W244	E245	Q246	A247	L248	Q249	A250	H251	M252	A253	K254	E255	L256	E257	Y258	L259	N260
R262	M263	K264	K265	K290	Q304	R305	K306	E317	E328	N342	R343	L344	H345	D346	I347	L348	N349	N350	L351	R352	S353	K354	Y355	A356	K357	Q358	L359	K360	Q363	E364	N366	Q367	D394	S447	GLN	PRO	GLN	GLN	GLN	LYS	SER	SER	ALA	THR	GLN	ILE	VAL	GLU	GLU	MET	MET						
ARG	SER	GLU	GLU	GLU	ALA	GLU	GLU	ALA	ALA	GLU	PRO	GLU	TYR	LEU	ASP	LEU	K490	T491	K493	R494	I495	L496	L499	F505	L506	I507	E508	L511	M521	E522	C523	Y524	L525	F532	L535	G536	I537	Y544	K545	N548																	
L551	K552	W553	R554	ALA	HIS	ARG	LEU	LEU	SER	SER	GLN	ILE	LYS	PRO	CYS	SER	GLN	ALA	ALA	GLU	MET	THR	SER	ARG	ARG	GLU	LEU	GLU	GLU	ALA	ALA	GLN	THR	MET	GLY	GLU	LYS	GLU	GLU	GLU	VAL	GLU	GLY	GLY	LYS	GLU	GLU	GLU	GLU								
GLU	THR	PRO	SER	F617	W618	W619	T620	H621	F622	H623	D624	W625	L626	K627	T628	L629	E630	A631	M634	G635	L636	LYS	PRO	ARG	ASP	ARG	ALA	PRO	LEU	VAL	ARG	GLN	LYS	ASN	W652	V734	LEU	ARG	VAL	PRO	THR	LYS															

• Molecule 3: Dynein regulatory complex protein 10

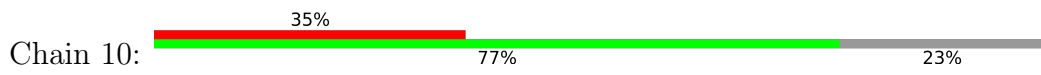

MET	ALA	LEU	ASP	ILE	LEU	ALA	ALA	MET	PRO	PRO	ALA	ALA	TYR	GLN	ALA	ALA	ASN	ILE	ILE	GLY	PRO	PRO	LYS	THR	ASP	PRO	PRO	VAL	VAL	SER	R41	T42	K43	L44	T45	A59	I60	Y61	K62	L65	L69	S74	E77	D78	M79						
E60	G61	M62	L63	G64	E65	D66	W67	M68	E69	H64	L67	L102	GLU	ASN	VAL	ARG	CYS	LEU	LEU	GLU	LYS	GLU	ARG	GLN	LEU	GLN	GLN	ALA	ALA	GLU	GLY	TRP	LEU	ARG	ASP	ARG	LEU	LEU	SER	LEU	ILE	ILE	LEU	LEU	GLN	K138	S139	S140	L141	D150	N154
R157	L160	S161	N162	P163	Q164	A165	A166	M171	Q172	T173	Q174	G175	R176	S177	A178	R206	A209	Q210	F211	L212	Q213	S216	R217	S220	N221	N222	Q223	Q224	L225	D227	T228	L229	E230	K231	E232	L233	A234	E235	R236	M237	K238	R240	N241	A242	E243	V244	E245	K246	E247	N248	F249
V250	I251	Q252	E253	N256	H259	R285	A292	K293	T294	Q295	Q296	E297	L298	L299	Q300	S303	Q304	D338	T339	E340	K341	G342	E343	K344	Q345	E346	E347	L348	D350	L351	D352	A353	V354	H355	R356	E357	E358	K359	A377	Q378	R380	E381	E382	R383	E384	I385	N386	S387	K388	K389	

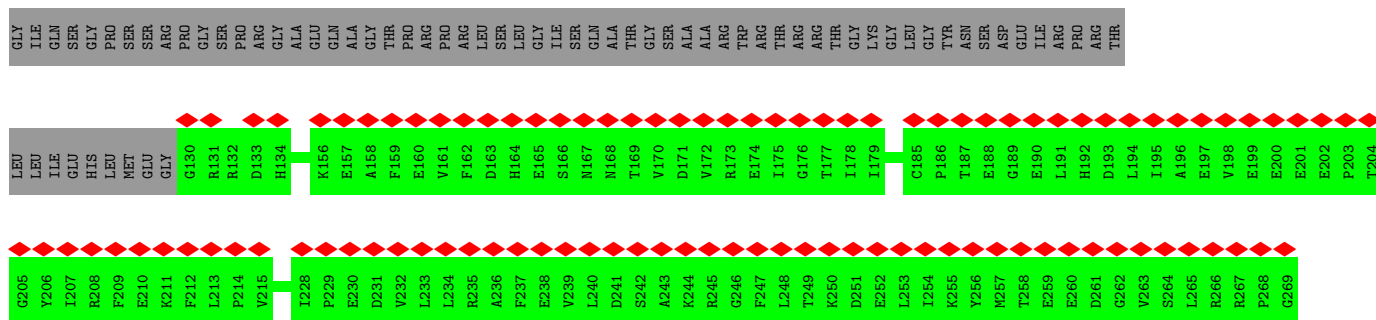

• Molecule 5: Dynein regulatory complex protein 8

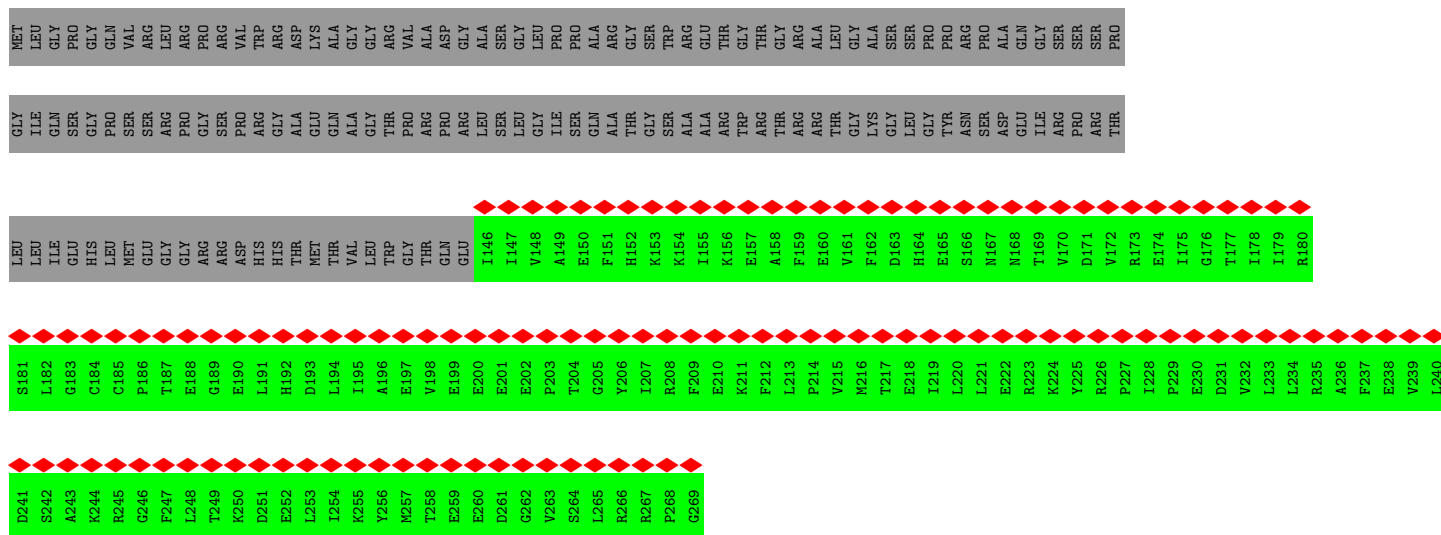

• Molecule 6: EF-hand domain-containing family member B

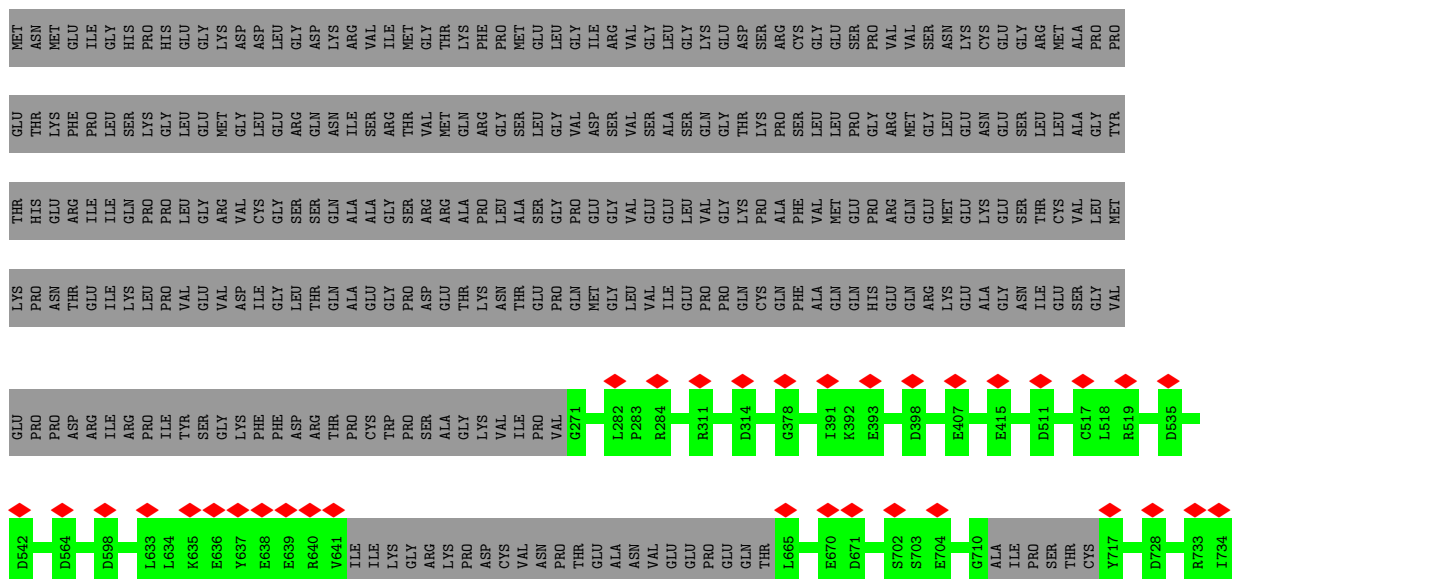

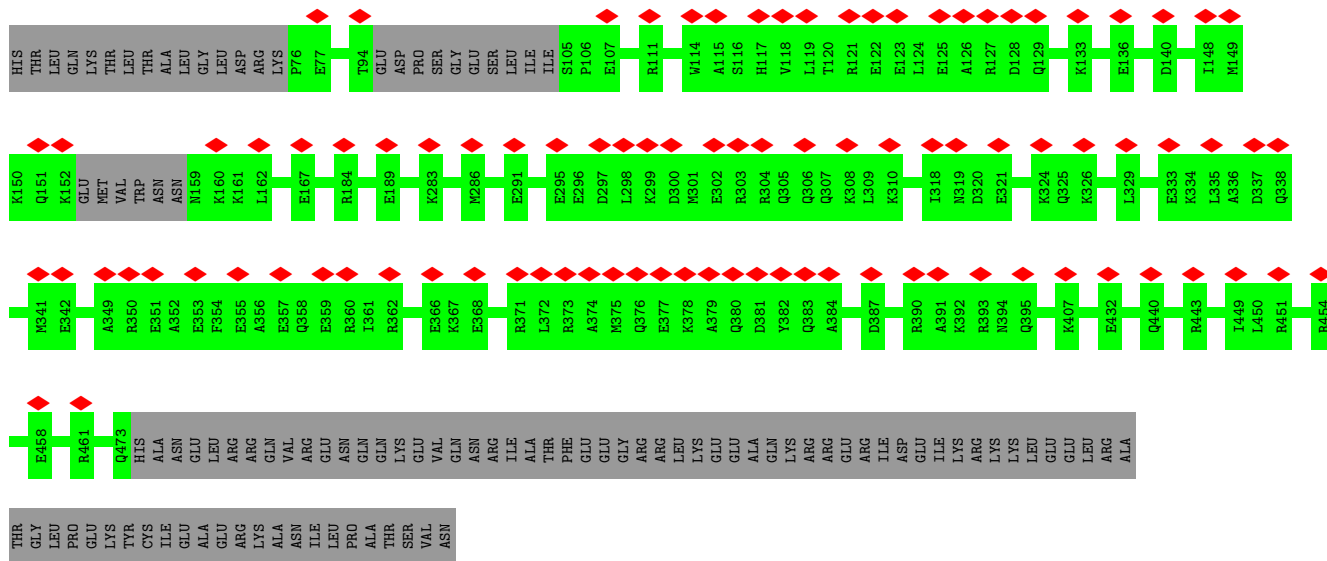

• Molecule 7: Cilia- and flagella-associated protein 45

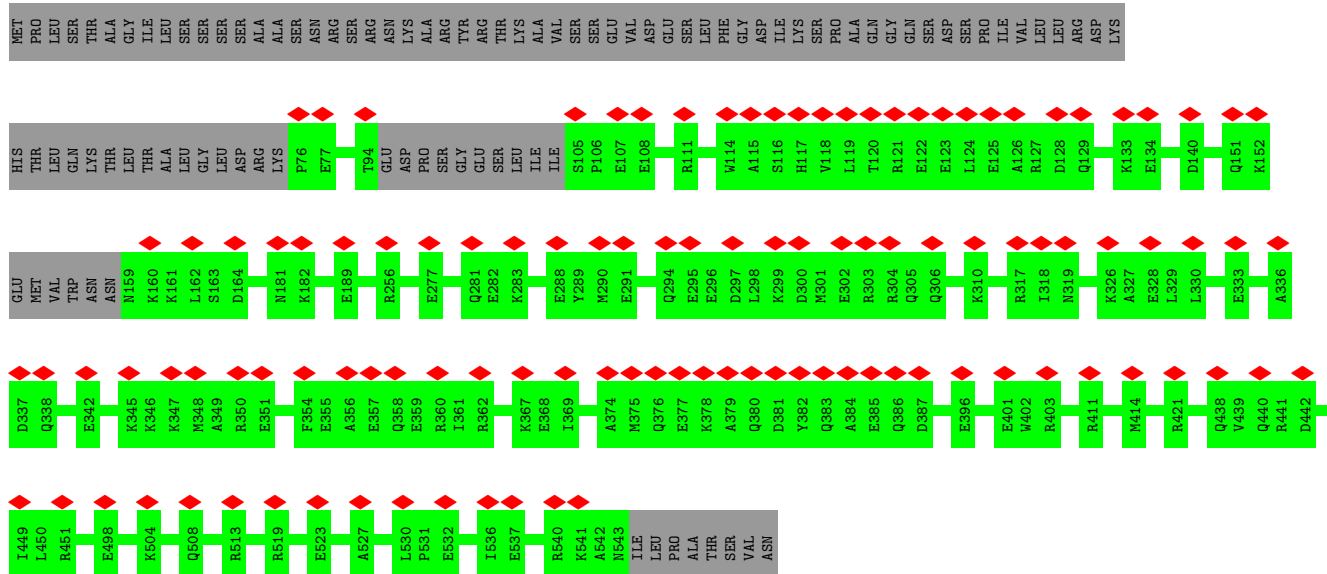
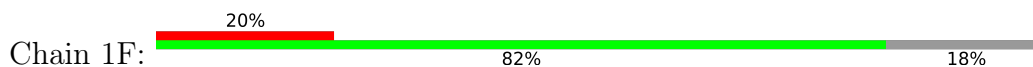

• Molecule 7: Cilia- and flagella-associated protein 45

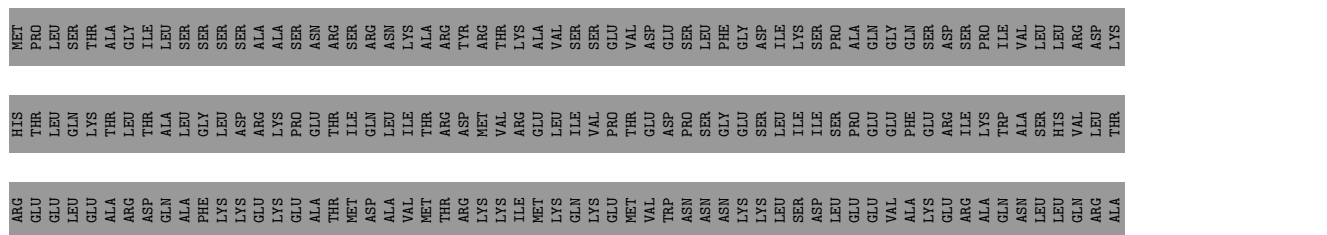

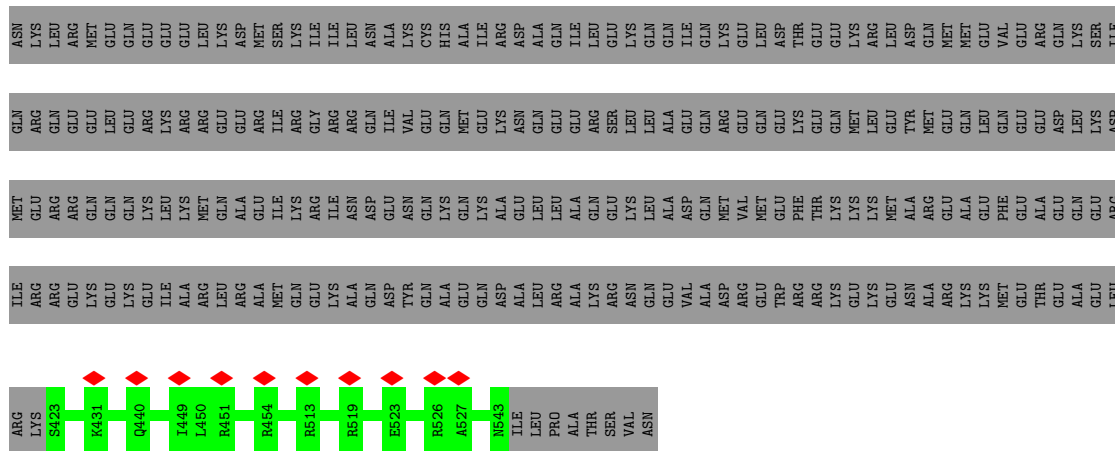

• Molecule 7: Cilia- and flagella-associated protein 45

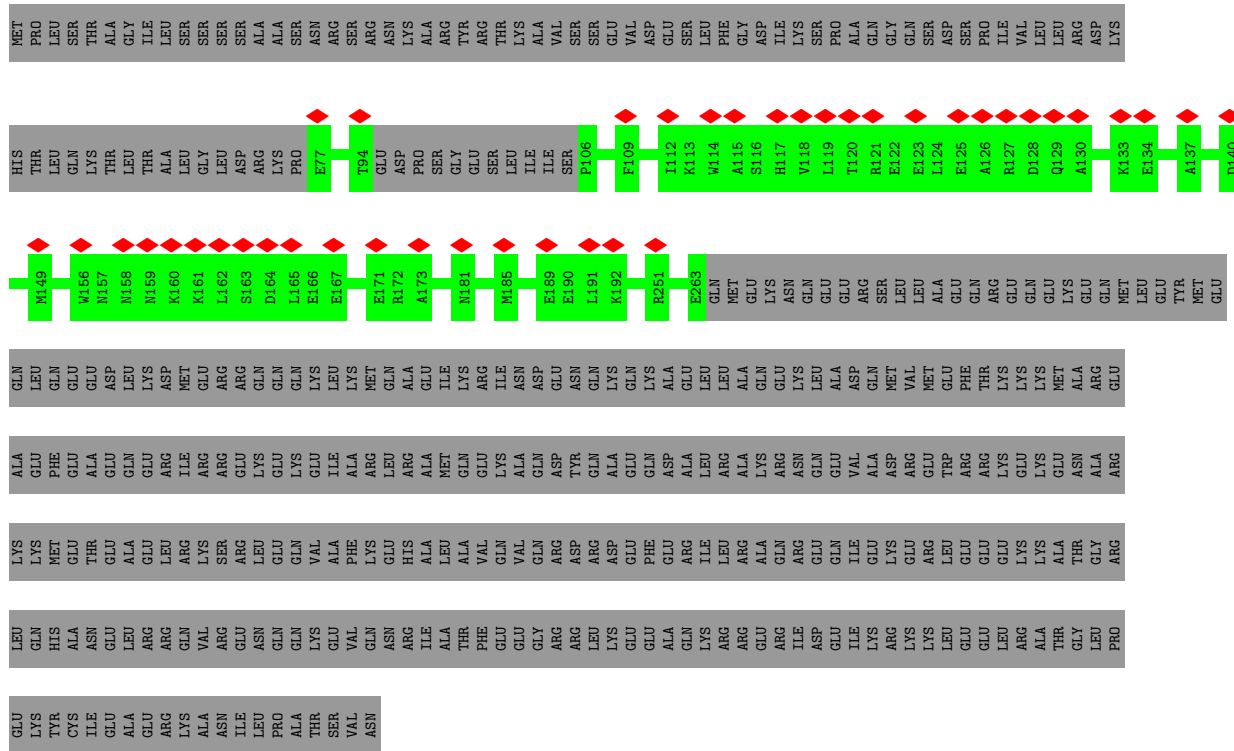

• Molecule 7: Cilia- and flagella-associated protein 45

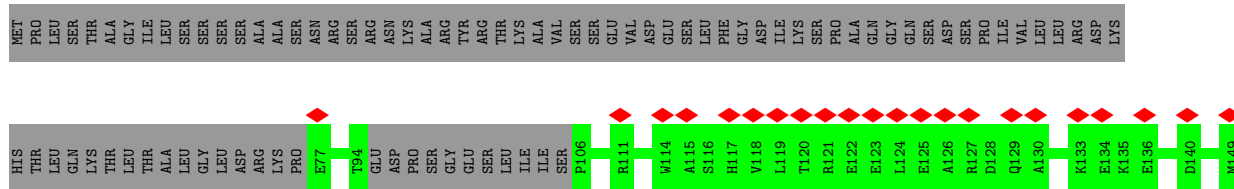
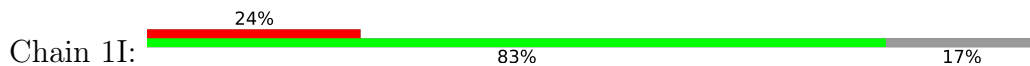

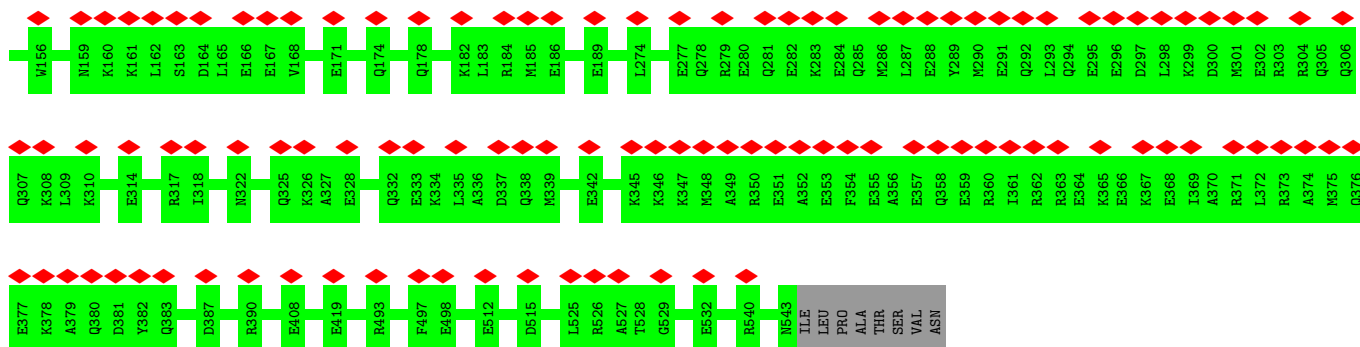

• Molecule 7: Cilia- and flagella-associated protein 45

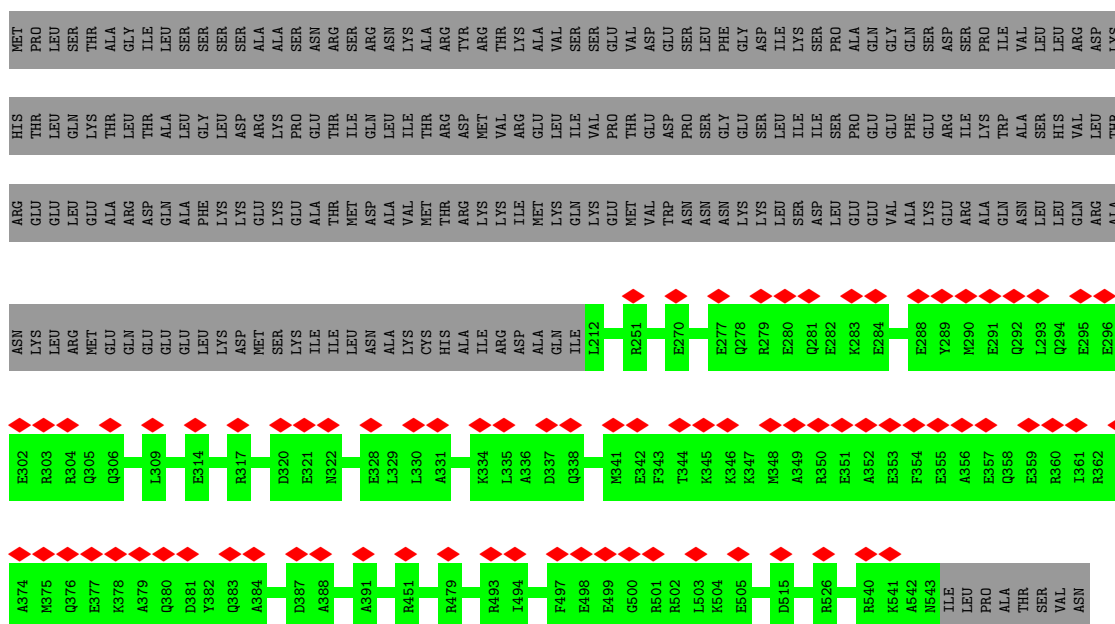

• Molecule 8: Cilia- and flagella-associated protein 52

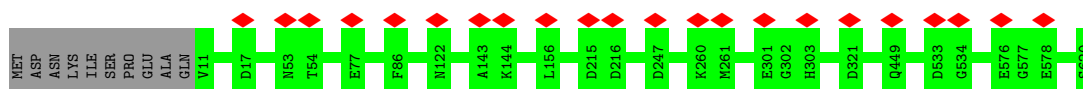

• Molecule 8: Cilia- and flagella-associated protein 52

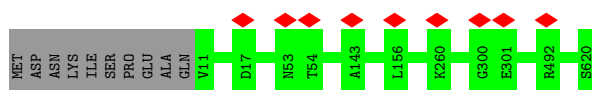

• Molecule 8: Cilia- and flagella-associated protein 52

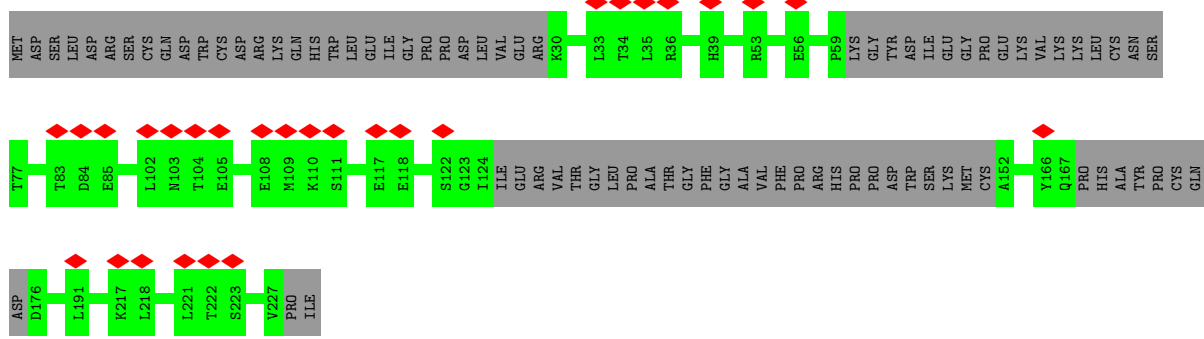

• Molecule 11: Cilia- and flagella-associated protein 107

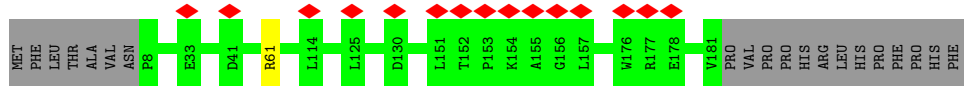
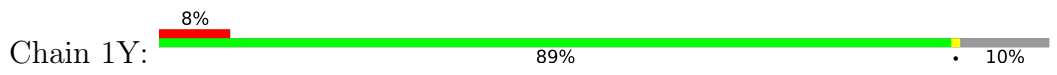

• Molecule 11: Cilia- and flagella-associated protein 107

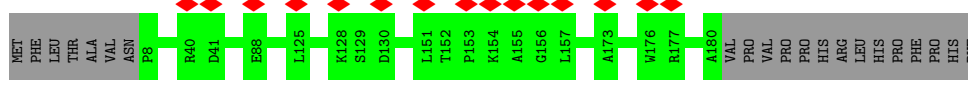
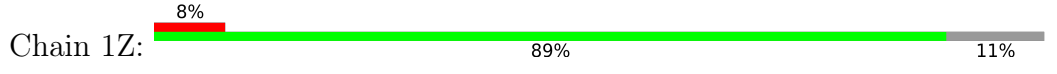

• Molecule 12: Dynein regulatory complex subunit 2

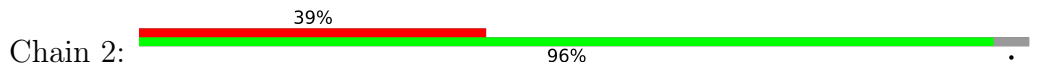

• Molecule 13: Protein Flattop

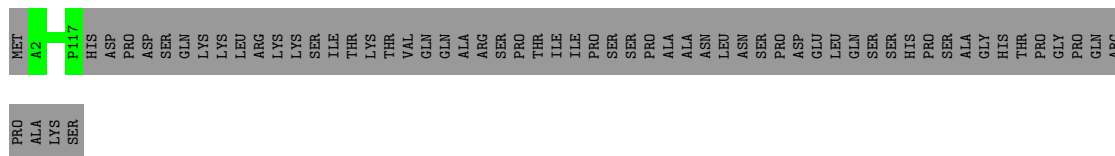

• Molecule 13: Protein Flattop

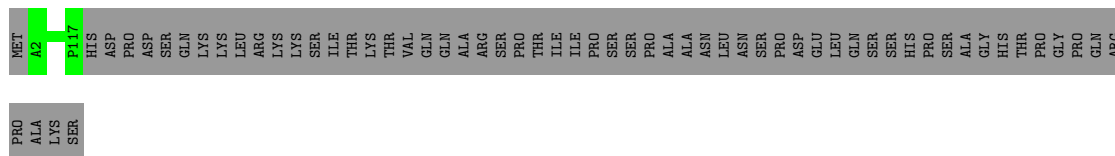

• Molecule 13: Protein Flattop

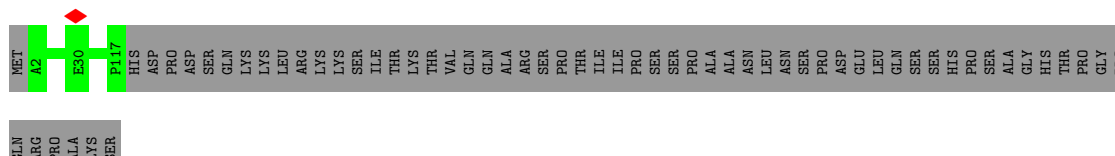

• Molecule 13: Protein Flattop

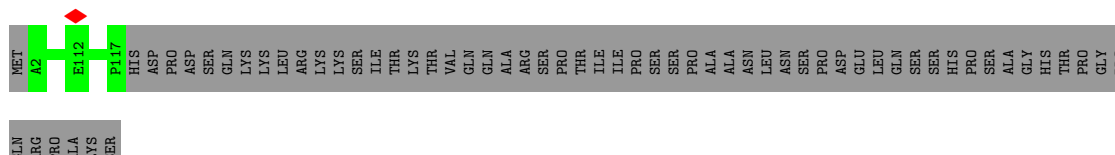

• Molecule 13: Protein Flattop

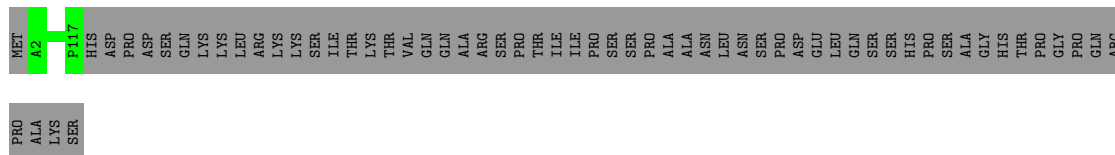

• Molecule 13: Protein Flattop



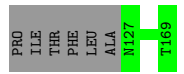
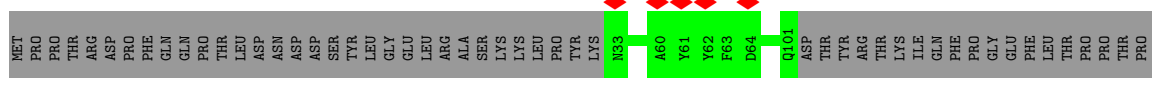

• Molecule 17: Cilia- and flagella-associated protein 276

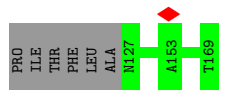
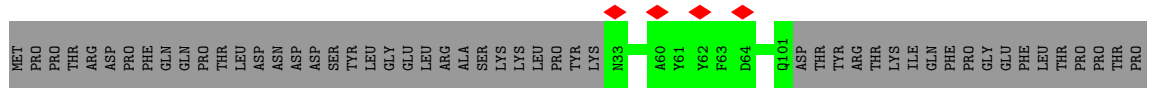

• Molecule 17: Cilia- and flagella-associated protein 276

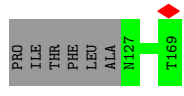
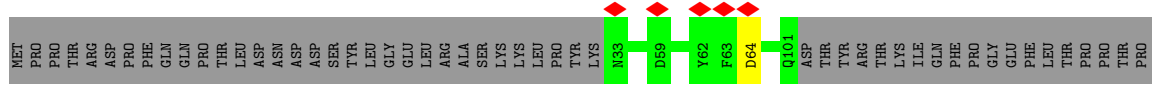

• Molecule 17: Cilia- and flagella-associated protein 276

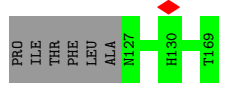
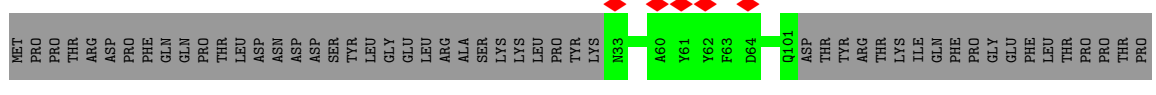

• Molecule 18: Dynein regulatory complex subunit 3

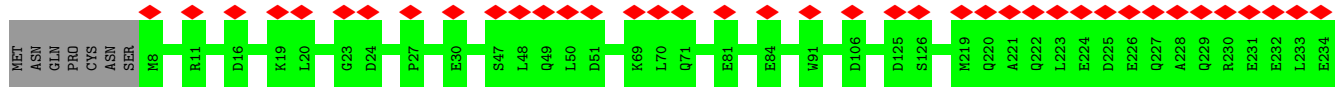

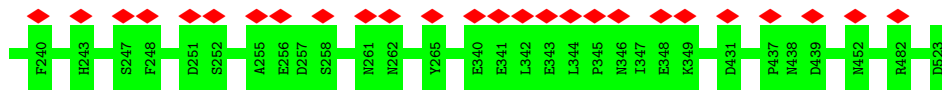

- Molecule 19: EF-hand domain-containing protein 1

Chain 3A: 76% 24%

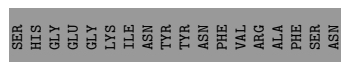
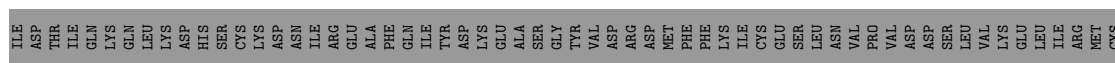
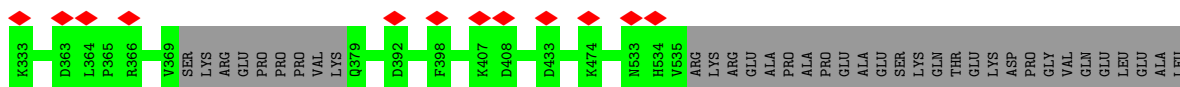
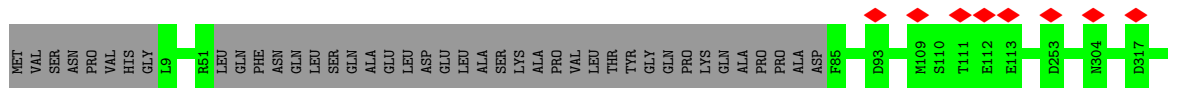

- Molecule 19: EF-hand domain-containing protein 1

Chain 3B: 76% 24%

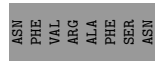
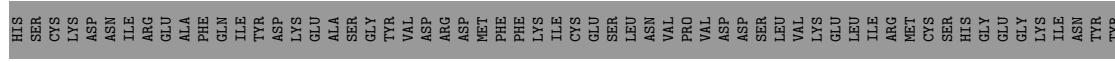
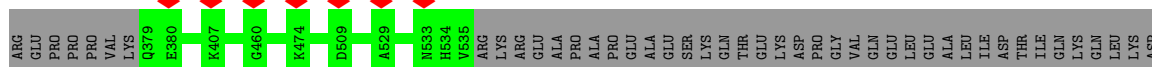
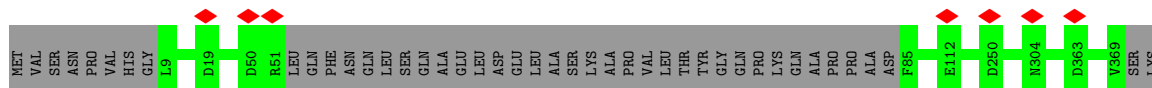

- Molecule 19: EF-hand domain-containing protein 1

Chain 3C: 76% 24%

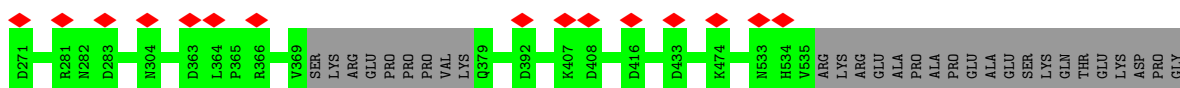
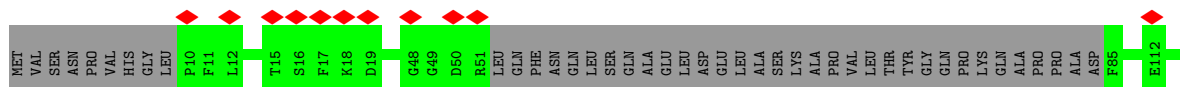

GLU
LEU
ILE
ARG
MET
CYS
SER
HIS
GLY
GLU
GLY
LYS
ILE
ILE
ASN
TYR
TYR
ASN
PHE
VAL
ARG
ALA
SER
SER
ASN

• Molecule 19: EF-hand domain-containing protein 1

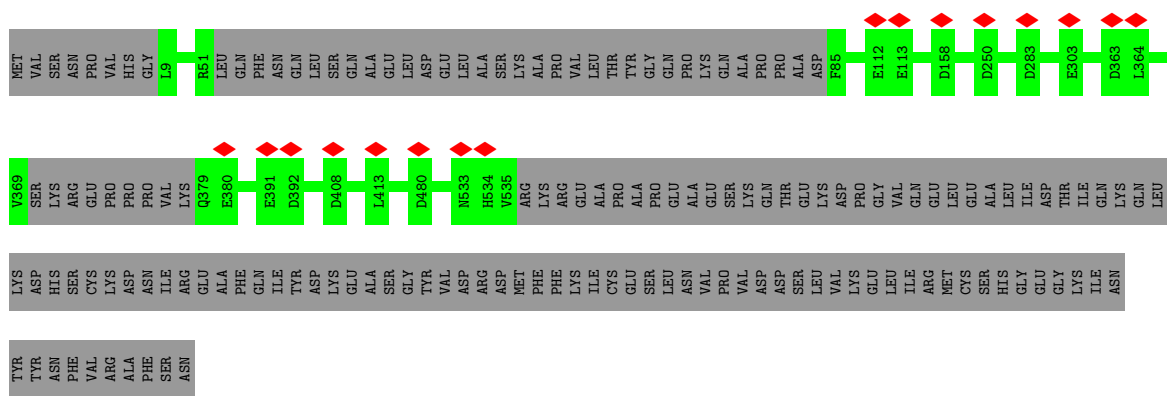
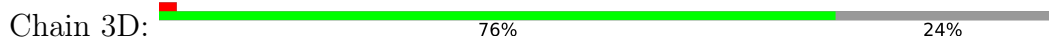

• Molecule 19: EF-hand domain-containing protein 1

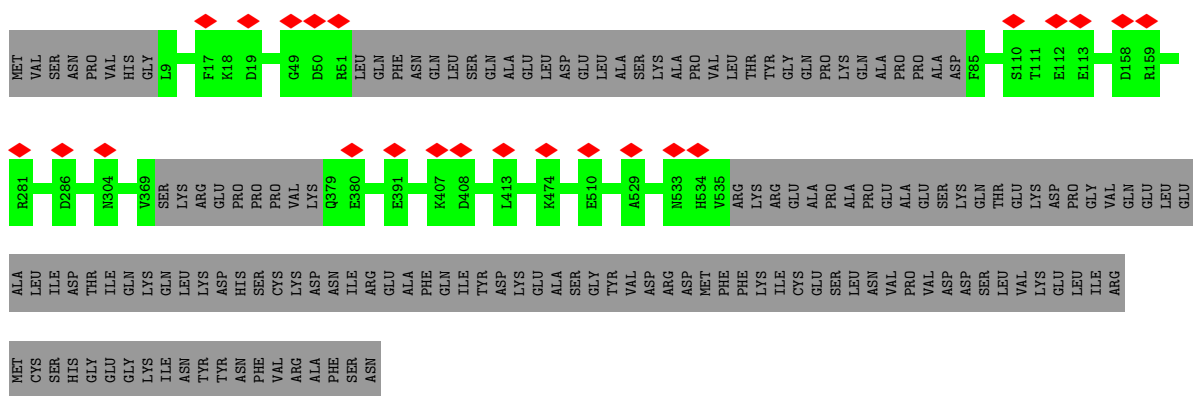
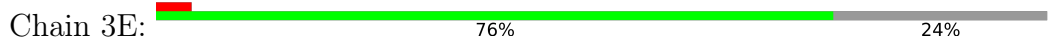

• Molecule 19: EF-hand domain-containing protein 1

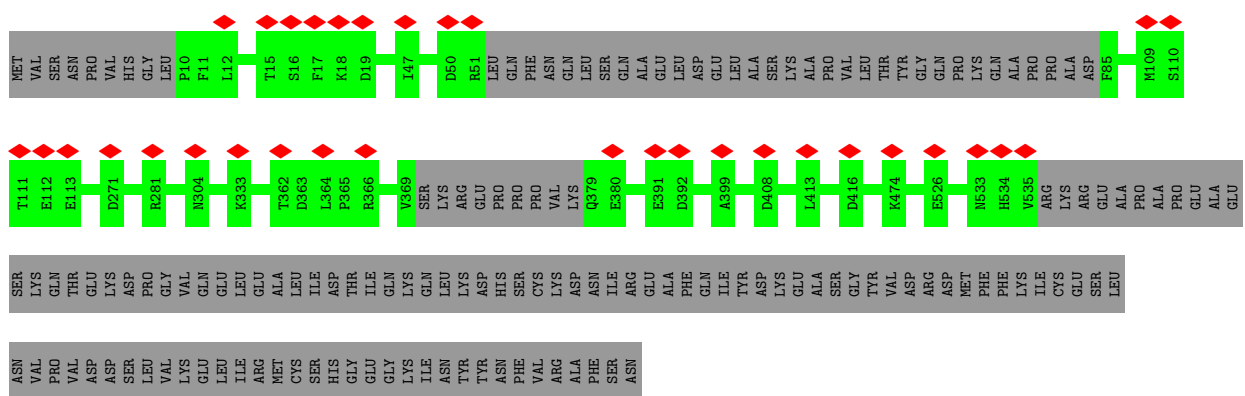
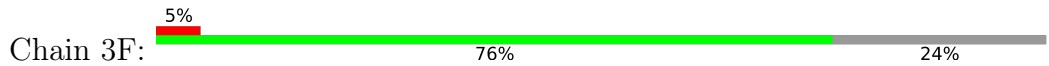

• Molecule 20: EF-hand domain-containing family member C2

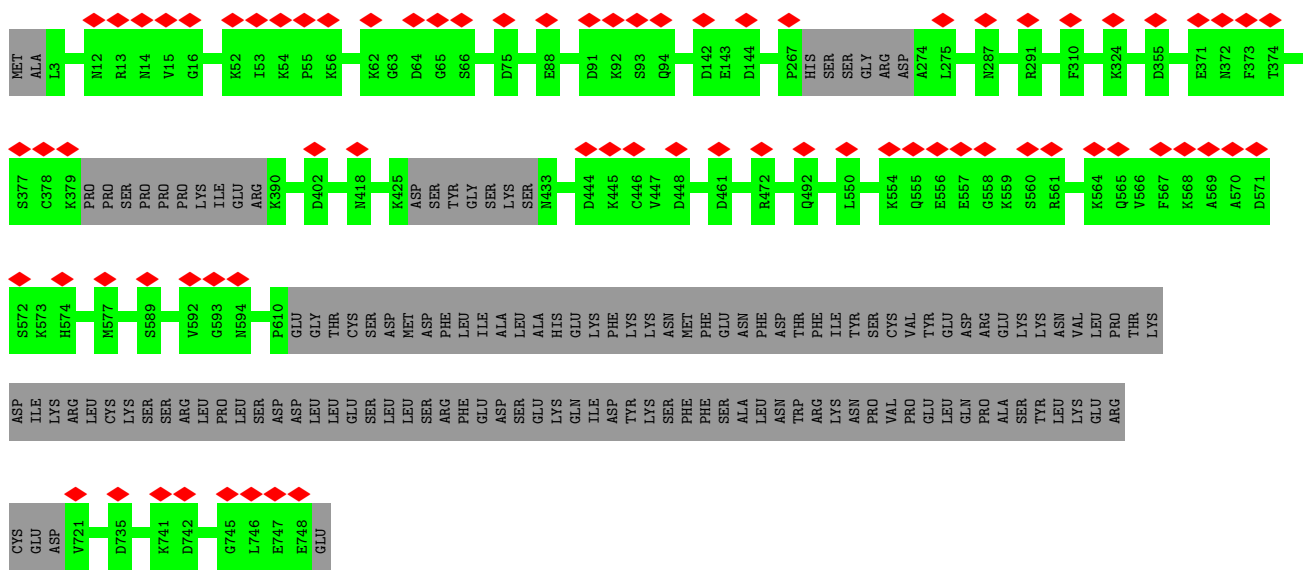
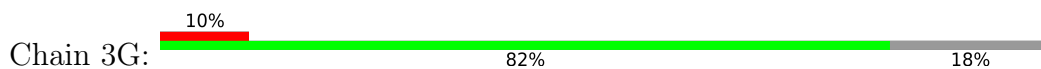

• Molecule 20: EF-hand domain-containing family member C2

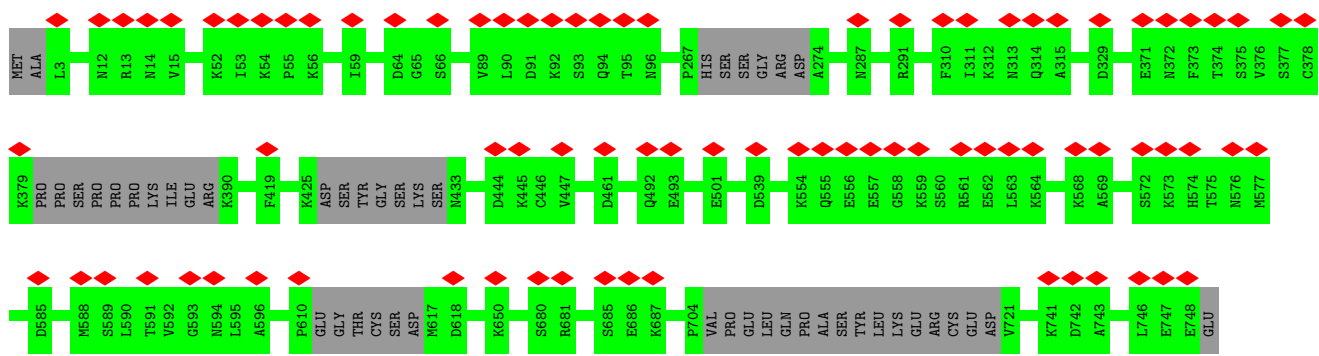

• Molecule 20: EF-hand domain-containing family member C2

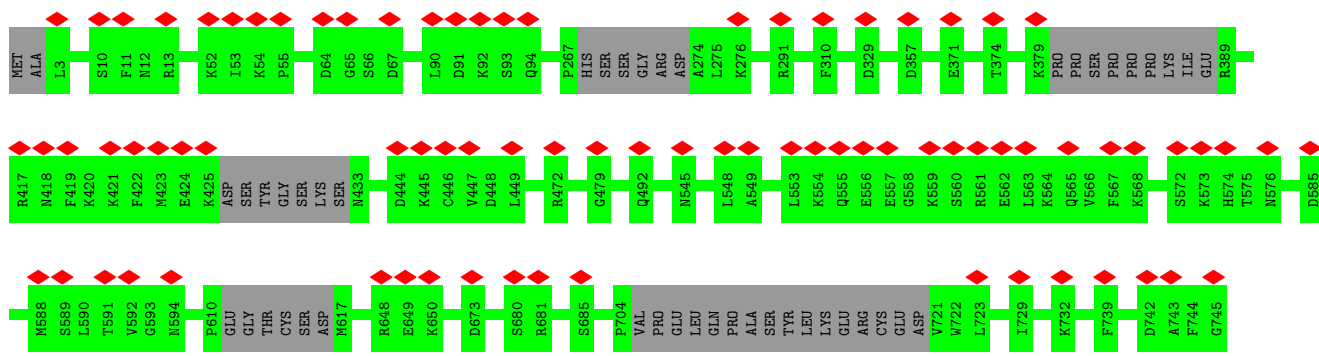
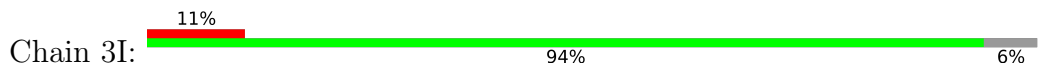



• Molecule 20: EF-hand domain-containing family member C2

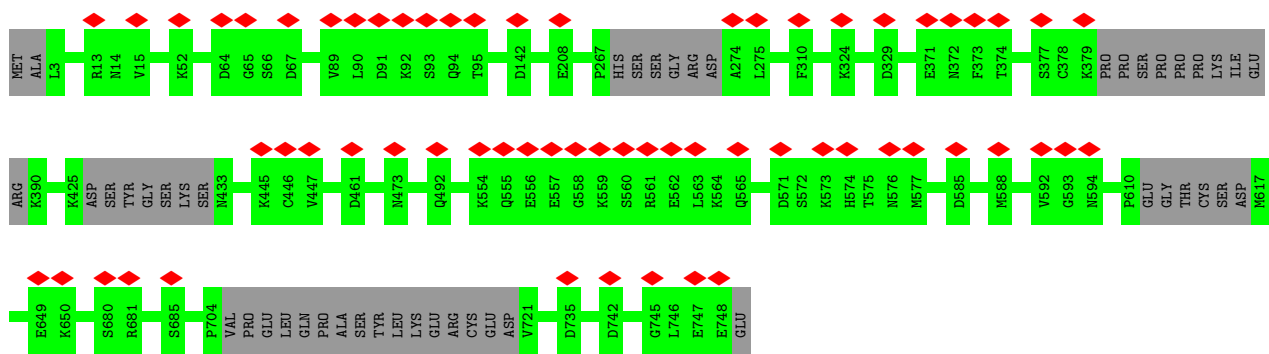

• Molecule 20: EF-hand domain-containing family member C2

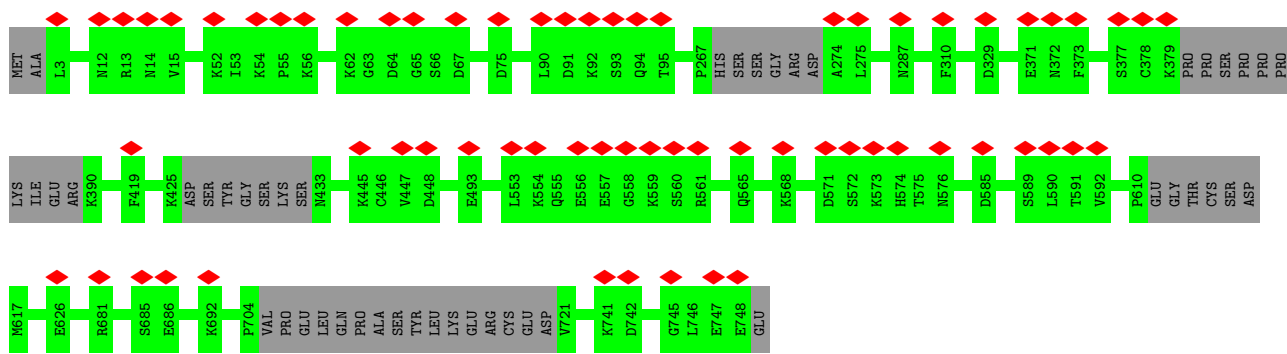

• Molecule 20: EF-hand domain-containing family member C2

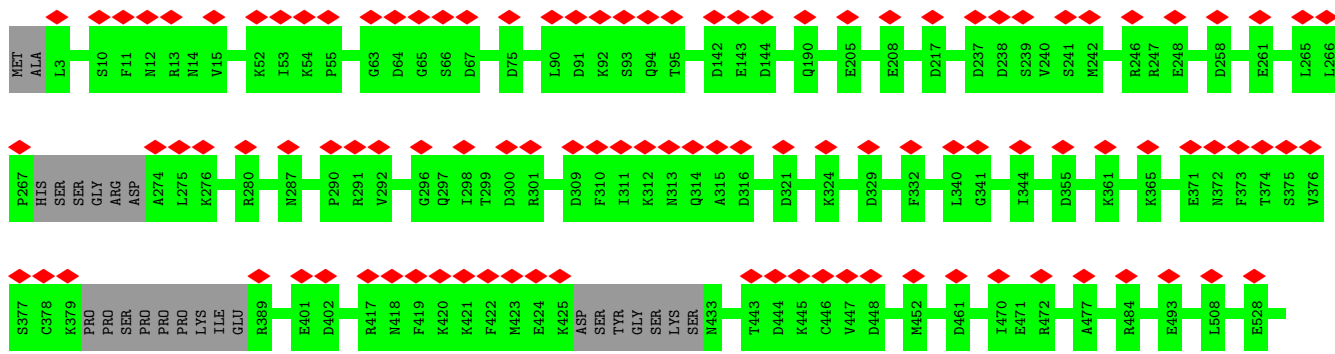

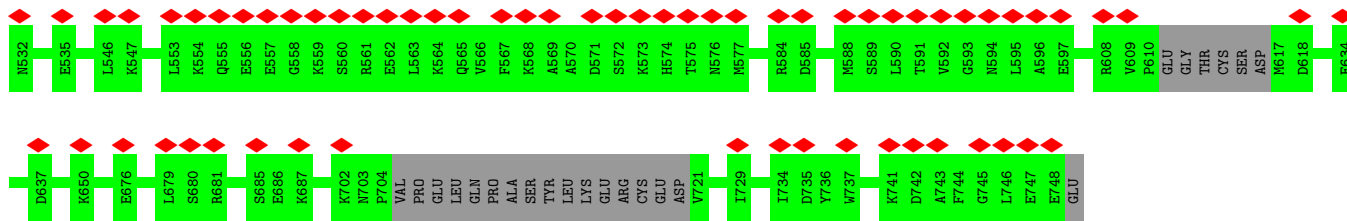

• Molecule 20: EF-hand domain-containing family member C2

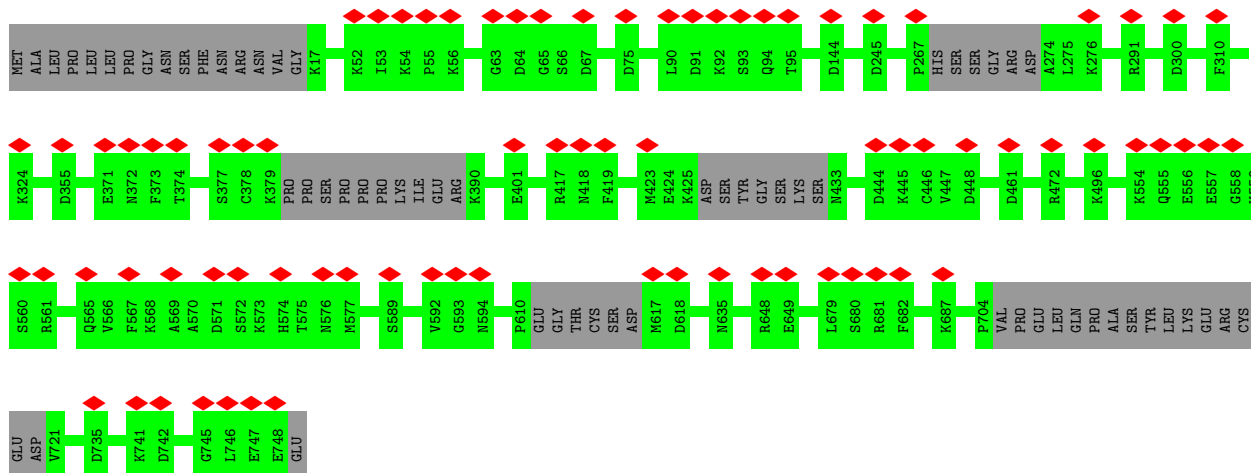
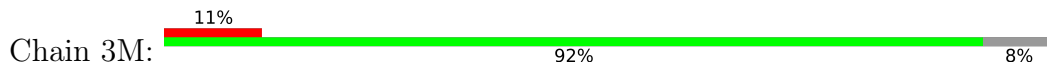

• Molecule 21: Enkurin

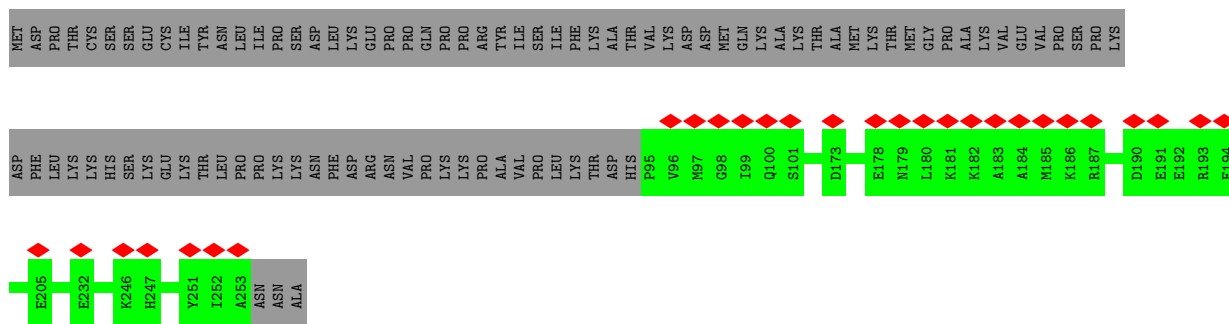

• Molecule 21: Enkurin

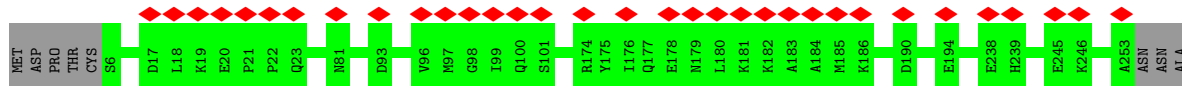

• Molecule 21: Enkurin



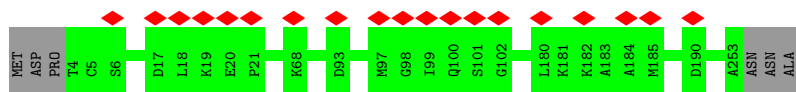

• Molecule 21: Enkurin

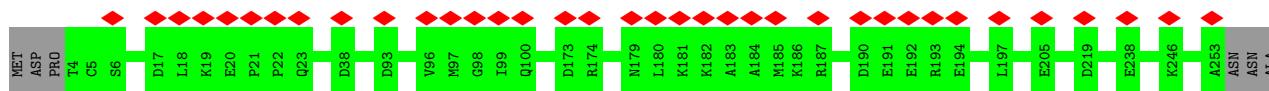

• Molecule 21: Enkurin

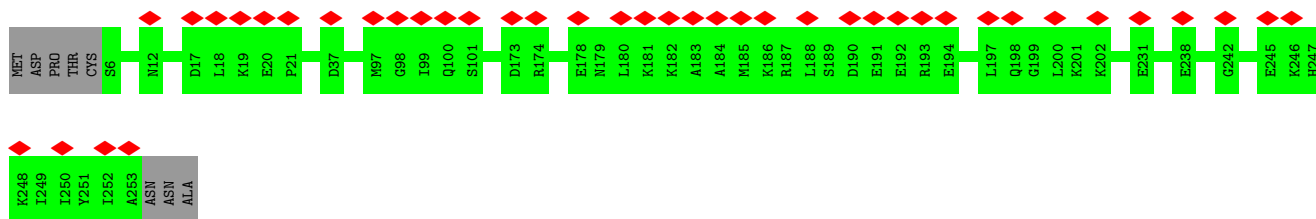

• Molecule 21: Enkurin

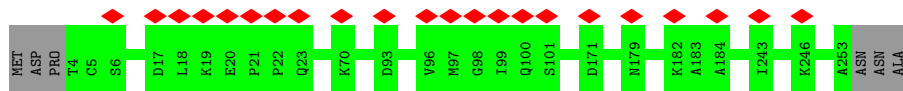

• Molecule 21: Enkurin

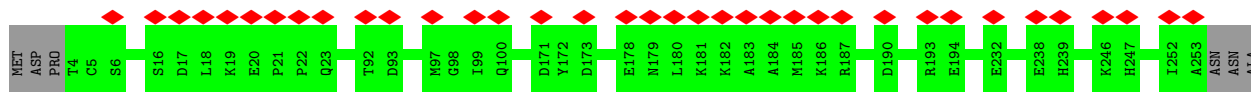

• Molecule 22: Meiosis-specific nuclear structural protein 1

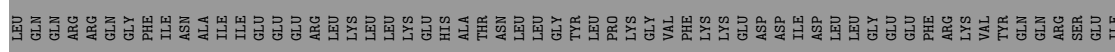
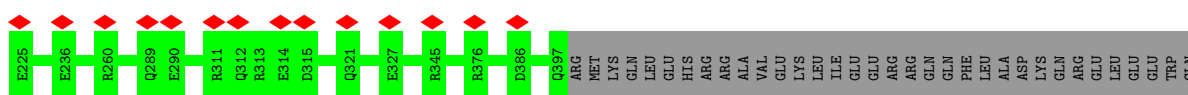
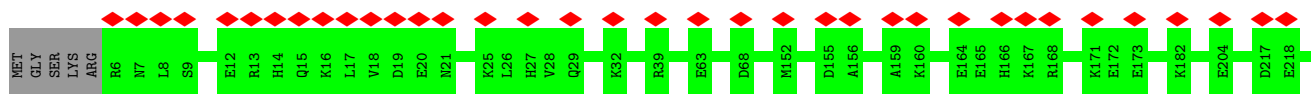
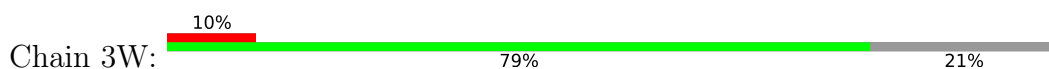

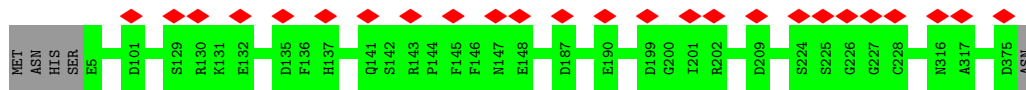

• Molecule 24: Nucleoside diphosphate kinase 7

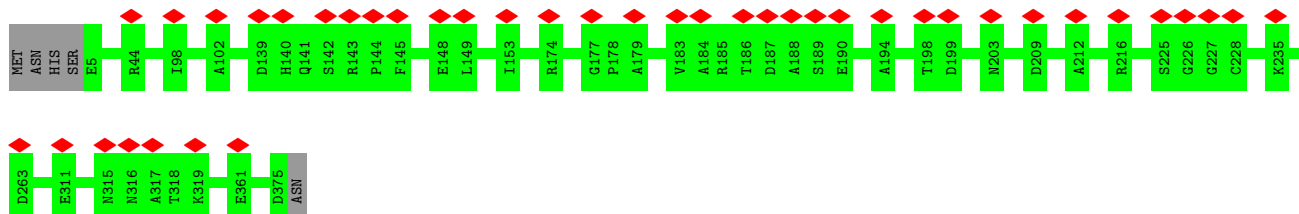

• Molecule 24: Nucleoside diphosphate kinase 7

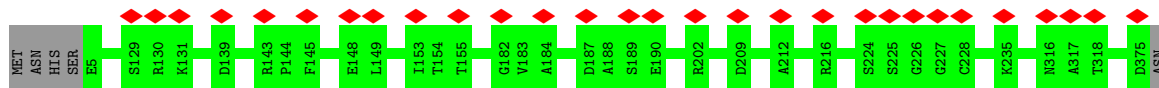

• Molecule 25: Piercer of microtubule wall 1 protein

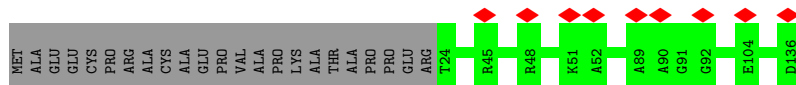
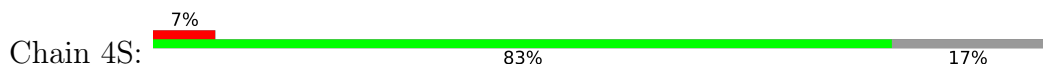

• Molecule 25: Piercer of microtubule wall 1 protein

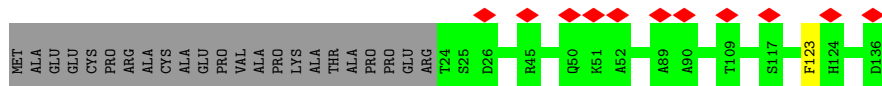
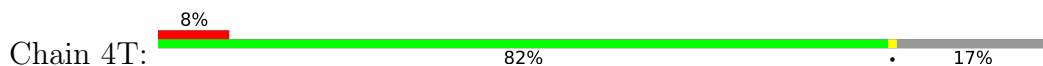

• Molecule 26: Piercer of microtubule wall 2 protein

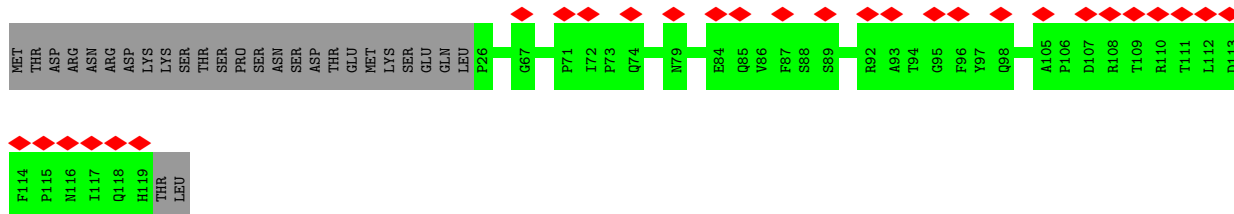
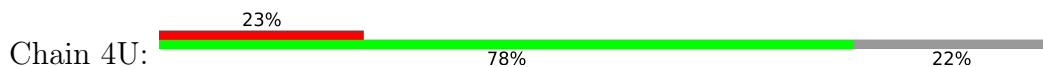

• Molecule 26: Piercer of microtubule wall 2 protein

ILE
THR
ALA
ASN
GLY
PRO
GLU
SER
VAL
GLY

• Molecule 28: RIB43A-like with coiled-coils protein 2

Chain 5A:



MET
GLY
SER
GLN
THR
MET
ALA
VAL
ALA
LEU
PHE
LEU
PRO
GLU
ARG
ASP
LEU
R15
Q16
D17
A18
N134
D197
T282
GLN
GLU
GLN
LEU
GLU
GLN
ILE
ARG
LEU
VAL
GLN
GLN
GLN
ILE
TYR
MET
GLY
LEU
ARG
LEU
VAL
TYR
GLN
THR
ASN
GLU
GLY
LYS
ARG
GLN
THR
GLN
ASP
PHE
LEU
THR
GLN
PHE
ASP
ARG
ASP
ARG
ARG

ILE
GLN
GLY
ALA
ARG
ALA
THR
LEU
LEU
PHE
LEU
PRO
GLU
ARG
ASP
LEU
TRP
ARG
ARG
GLN
GLN
ASP
LEU
ASP
SER
SER
ASN
LEU
SER
LEU
ALA
LYS
LEU
VAL
GLN
HIS
LEU
GLN
LYS
TYR
MET
ASN
GLY
VAL
TYR
ASN
GLN
PRO
THR
GLY
ASP
TYR
PHE
THR
GLN
PHE
ASP
ASN

THR
GLY
SER
ARG

• Molecule 28: RIB43A-like with coiled-coils protein 2

Chain 5B:

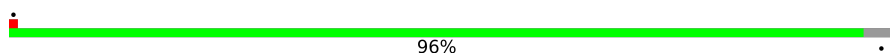

MET
GLY
SER
GLN
THR
MET
ALA
VAL
ALA
LEU
PHE
LEU
PRO
GLU
ARG
ASP
LEU
R15
Q16
D17
A18
N134
D315
R382

• Molecule 28: RIB43A-like with coiled-coils protein 2

Chain 5C:



MET
GLY
SER
GLN
THR
MET
ALA
VAL
ALA
LEU
PHE
LEU
PRO
GLU
ARG
ASP
LEU
ARG
GLN
GLN
LYS
VAL
PHE
LEU
CYS
GLU
ARG
GLN
LYS
ARG
LYS
VAL
PHE
LEU
CYS
ASN
ALA
ARG
ASN
ILE
ASP
ILE
GLY
GLN
GLY
ASP
THR
GLU
TRP
SER
LEU
PRO
GLU
THR
VAL
GLN
ARG
VAL
HIS
GLU
ASP
PHE
GLN
LYS
ASP
GLN
LYS
ILE
SER
ASP
LEU
LYS
ILE
ASP
SER
GLU

ALA
THR
GLY
LYS
ALA
HIS
GLU
THR
ALA
PHE
LEU
GLN
ALA
SER
ALA
MET
MET
CYS
ILE
GLY
LEU
GLN
LYS
GLU
ASN
LYS
PHE
MET
LYS
LYS
GLY
ASP
GLU
THR
ARG
LYS
PHE
HIS
ASN
LEU
PHE
GLY
GLU
CYS
ARG
LYS
ALA
LYS
PHE
GLN
ASN
PHE
ILE
ASP
PHE
GLN
GLN
ASN
ARG
SER
PHE
GLN
TRP
SER
LEU
GLN
THR
VAL
GLN
ARG
GLU
HIS
ASP
PHE
LYS
ASP
LEU
LYS
ILE
SER
ASP
LEU
LYS
ILE
ASP
SER
GLU

LEU
ALA
LYS
LYS
ASP
LEU
PRO
GLU
ALA
THR
GLU
GLN
SER
ASP
ASN
ASP
VAL
GLN
PHE
GLY
MET
GLY
LEU
GLN
LYS
PHE
MET
LYS
LYS
GLU
ASP
GLU
THR
ARG
LYS
PHE
HIS
ASN
LEU
PHE
GLY
GLU
CYS
ARG
LYS
LYS
PHE
GLN
ASN
PHE
ILE
ASP
PHE
GLN
GLN
ASN
ARG
SER
PHE
GLN
TRP
SER
LEU
GLN
THR
VAL
GLN
ARG
GLU
HIS
ASP
PHE
LYS
ASP
LEU
LYS
ILE
SER
ASP
LEU
LYS
ILE
ASP
SER
GLU

GLU
GLN
CYS
ALA
GLU
ALA
LEU
TYR
THR
GLU
THR
ARG
LEU
GLN
PHE
GLY
ASP
GLU
THR
ALA
LYS
HIS
LYS
LEU
GLN
LYS
LEU
GLU
SER
THR
ARG
LYS
R213
R308
R382

• Molecule 29: RIB43A-like with coiled-coils protein 1

Chain 5D:



MET
TYR
ASN
ILE
LYS
GLN
SER
THR
ASP
THR
ARG
LYS
LEU
GLU
ALA
ALA
A15
I16
E17
A18
R19
R20
M21
R22
E23
R24
E25
R26
Q27
R28
R29
F30
F31
R32
V33
R34
R35
R36
G39
V40
D41
V42
Q43
M46
M47
D51
R52
R53
R54
R55
E56
A58
E59
R60
S61
K62
M79

L80
E81
K82
E83
E84
A85
D86
H87
T88
R89
Q90
K93
K94
E97
E100
Q101
K102
Q103
GLN
LEU
LYS
ASN
GLY
GLN
ARG
GLU
PHE
SER
LEU
TRP
ASP
TRP
ASN
PRO
TYR
THR
GLN
VAL
TRP
LYS
GLY
LEU
PRO
THR
TYR
LEU
SER
TYR
SER
ALA
ASN
THR
TYR
PRO
GLY
HIS
PRO
ALA
SER
LEU
TYR
PHE

SER
GLY
GLU
ASP
LEU
ASP
ARG
ASP
THR
THR
ARG
LEU
LEU
MET
GLN
GLY
GLY
PHE
GLN
ARG
TYR
ASN
LEU
GLU
ARG
GLN
GLN
GLN
GLU
GLY
GLN
GLN
ALA
LYS
VAL
SER
LEU
GLU
TRP
ASP
GLY
ASN
TYR
THR
ASP
ALA
VAL
SER
ASN
GLN
LEU
ARG
TRP
LEU
ALA
MET
ASP
ALA
GLN
THR
THR
PRO
GLY
HIS
LEU
PRO
ALA
SER
LEU
TYR
PHE

GLU GLU SER ASN ILE LYS LYS ARG ALA MET MET MET MET CYS CYS CYS CYS ALA ALA ALA ASN

PRO MET ALA PRO TYR ARG VAL LEU PRO MET CYS VAL TRP MET LYS GLY MET ARG LEU THR PRO GLU SER GLN ALA ALA VAL VAL GLN ILE ARG ALA LYS GLY ARG GLN GLN

GLU LEU GLU TYR ARG VAL LEU PRO MET CYS VAL TRP MET LYS GLY MET ARG LEU THR PRO GLU SER GLN ALA ALA VAL VAL GLN ILE ARG ALA LYS GLY ARG GLN GLN

• Molecule 29: RIB43A-like with coiled-coils protein 1

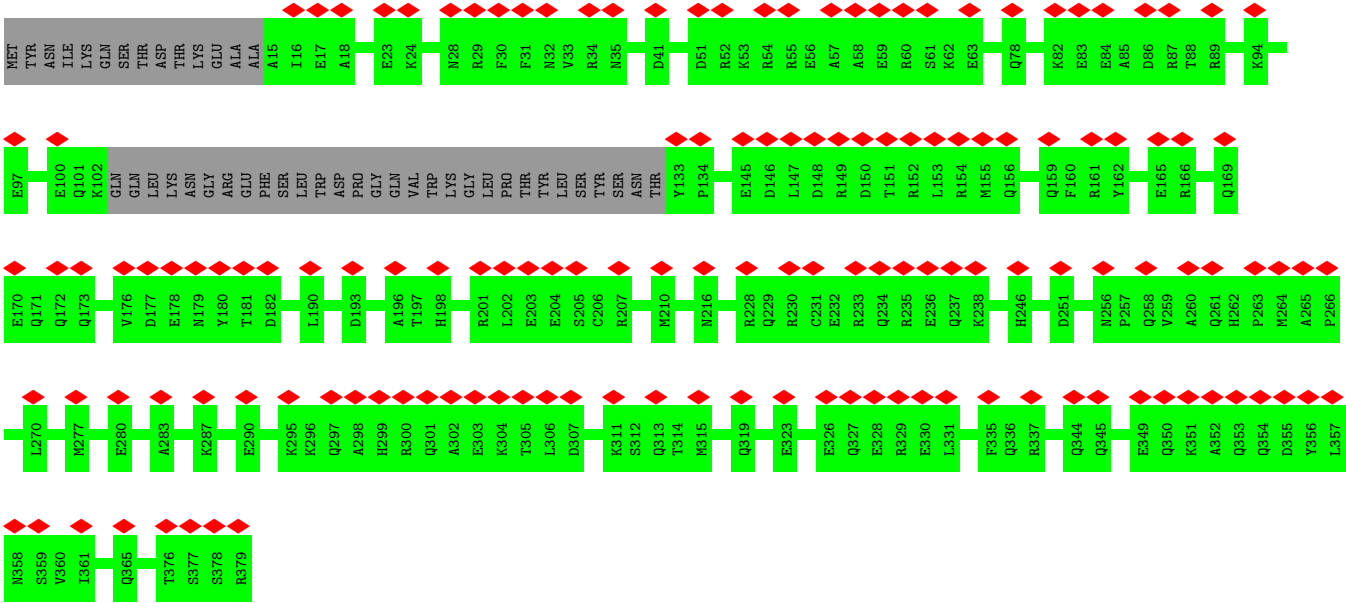
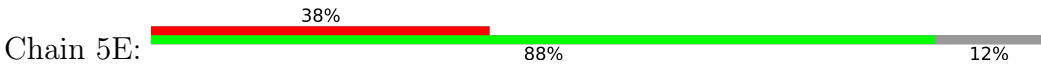

• Molecule 29: RIB43A-like with coiled-coils protein 1

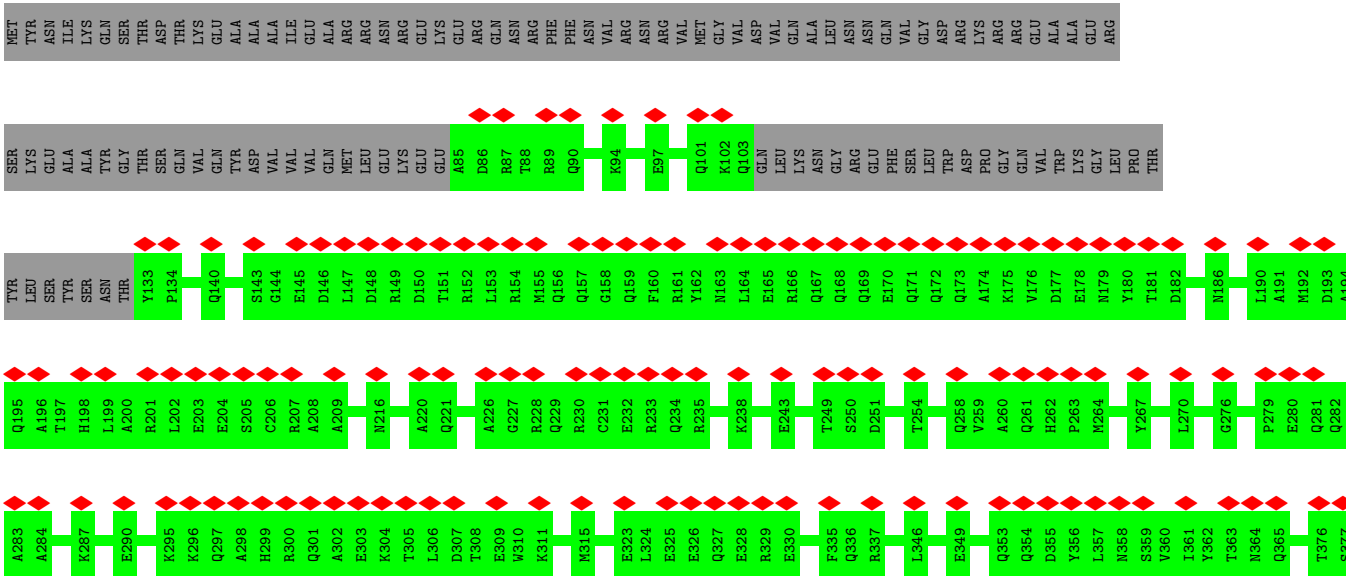

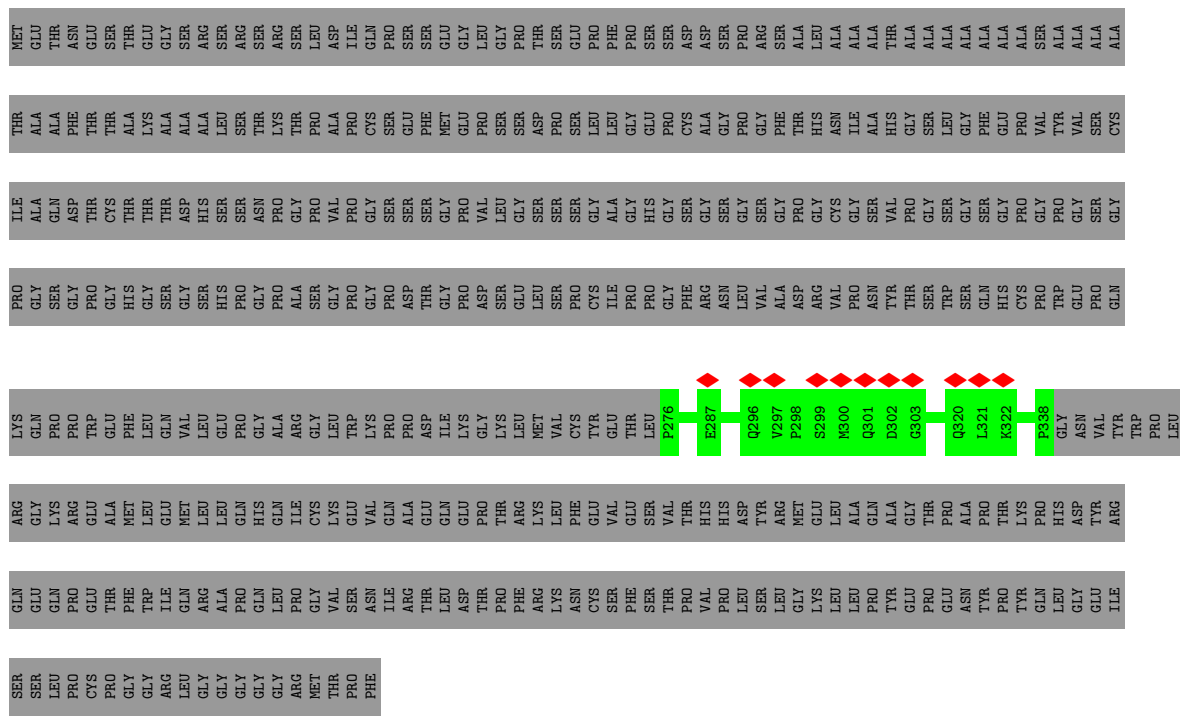

• Molecule 31: Uncharacterized protein CFAP68

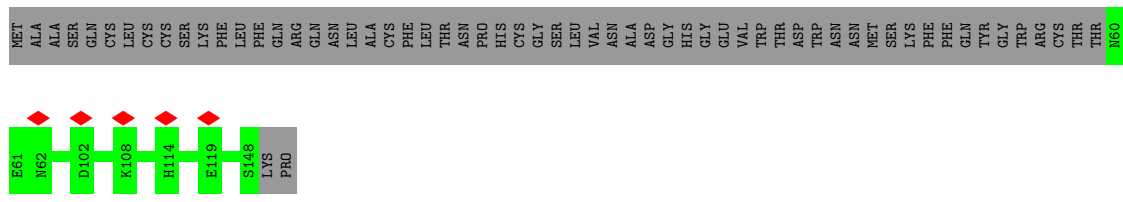

• Molecule 31: Uncharacterized protein CFAP68

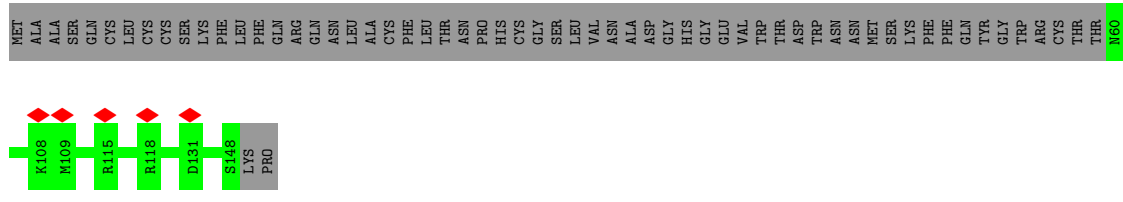

• Molecule 32: Cilia- and flagella-associated protein 77

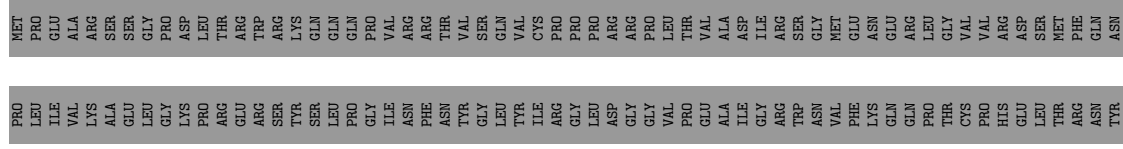

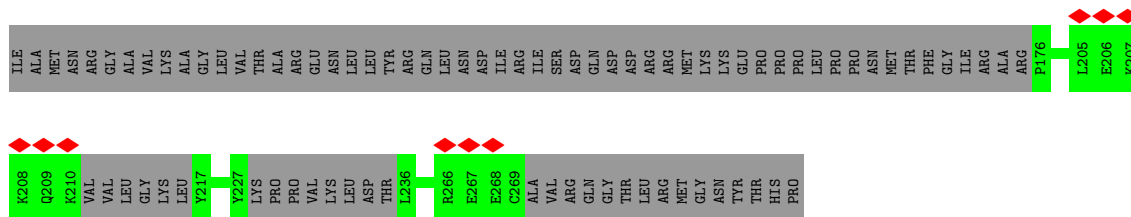

• Molecule 32: Cilia- and flagella-associated protein 77

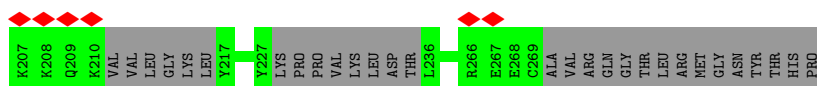
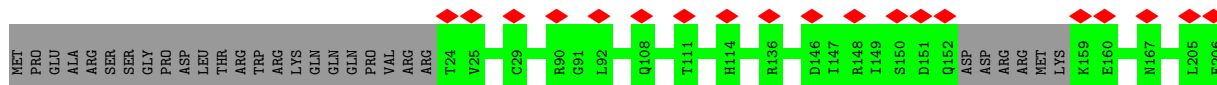
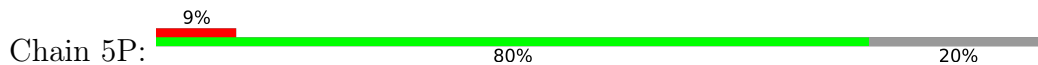

• Molecule 32: Cilia- and flagella-associated protein 77

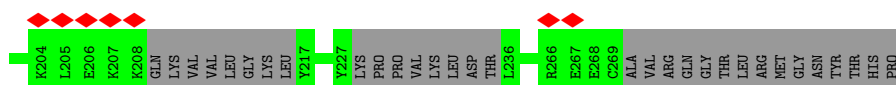
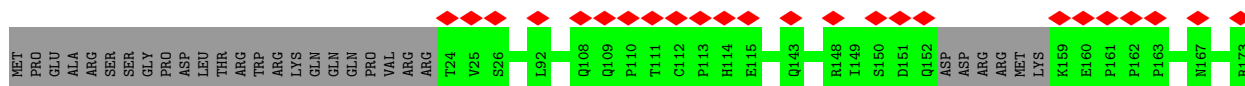
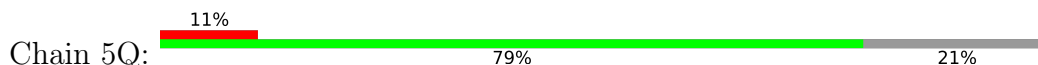

• Molecule 32: Cilia- and flagella-associated protein 77

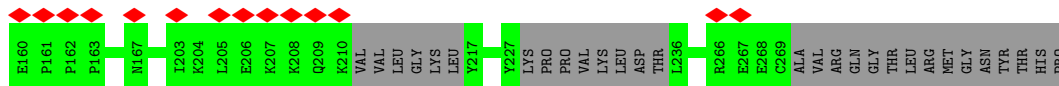
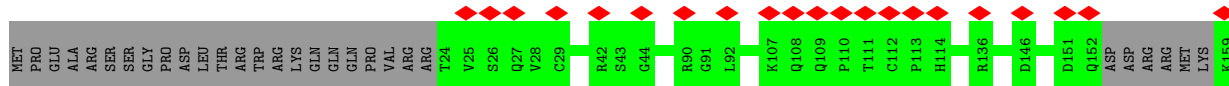
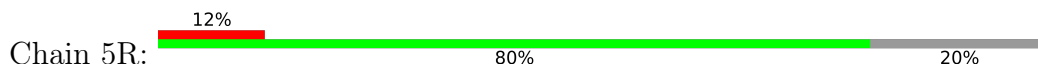

• Molecule 32: Cilia- and flagella-associated protein 77

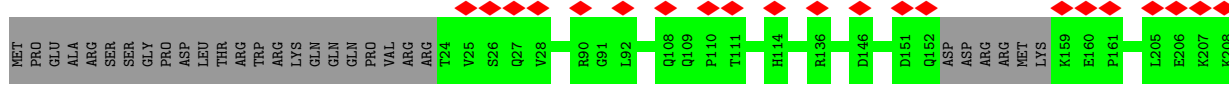
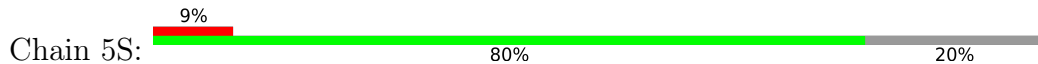

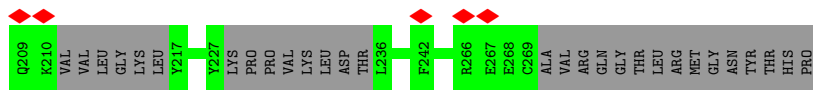

• Molecule 32: Cilia- and flagella-associated protein 77

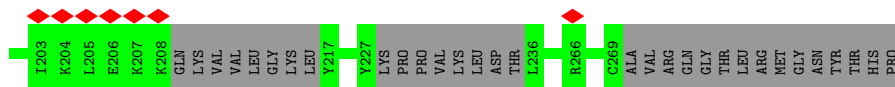
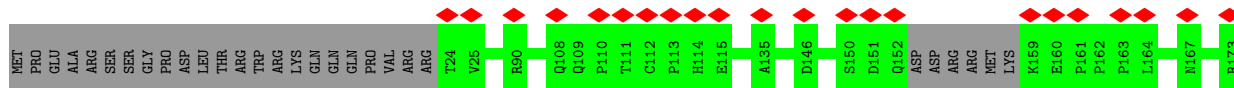
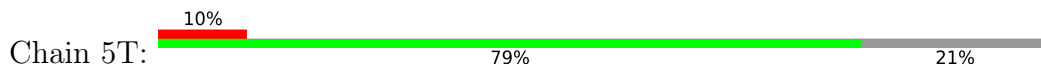

• Molecule 32: Cilia- and flagella-associated protein 77

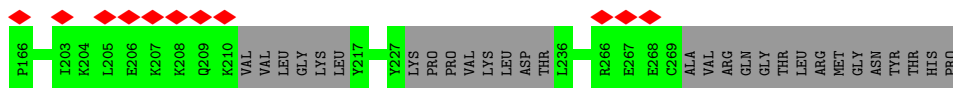
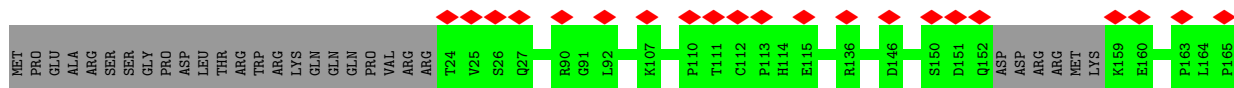
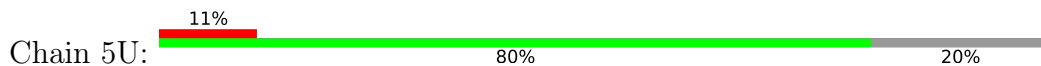

• Molecule 32: Cilia- and flagella-associated protein 77

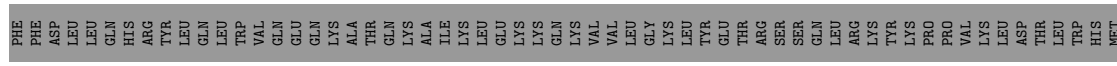
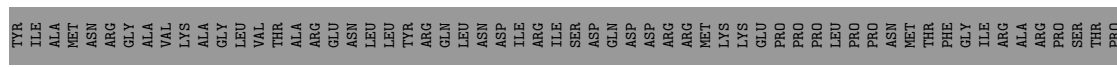
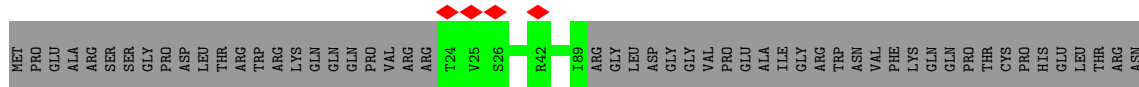

• Molecule 33: Uncharacterized protein CFAP90

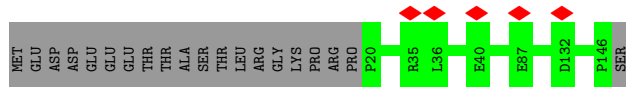
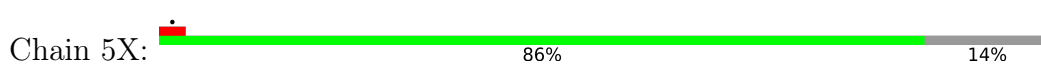

• Molecule 33: Uncharacterized protein CFAP90

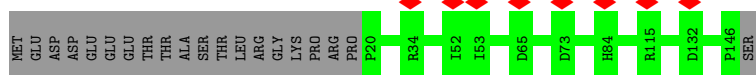
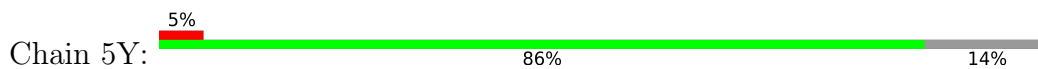

• Molecule 34: Sperm acrosome-associated protein 9

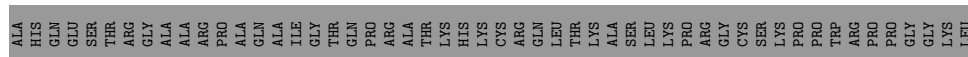
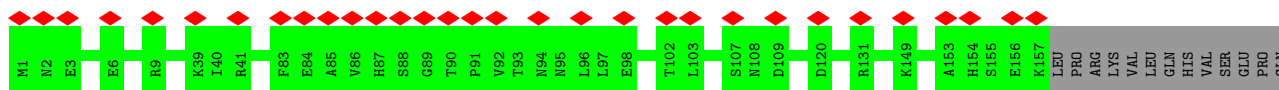
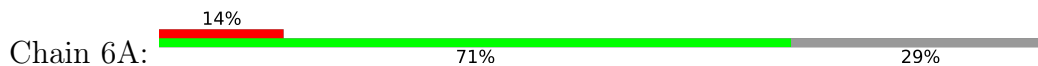

• Molecule 34: Sperm acrosome-associated protein 9

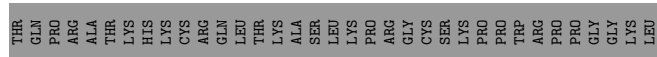
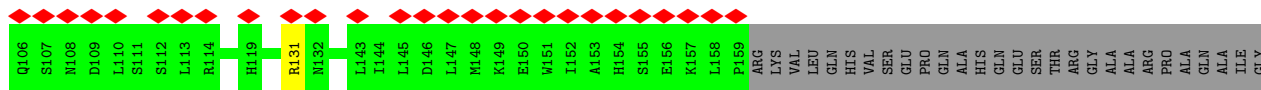
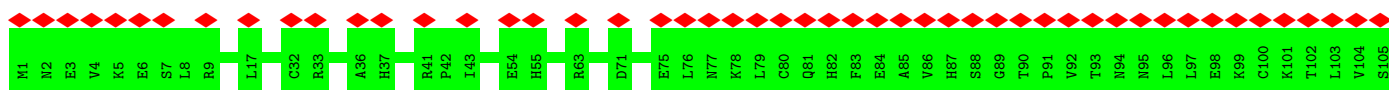

• Molecule 34: Sperm acrosome-associated protein 9

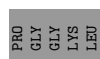
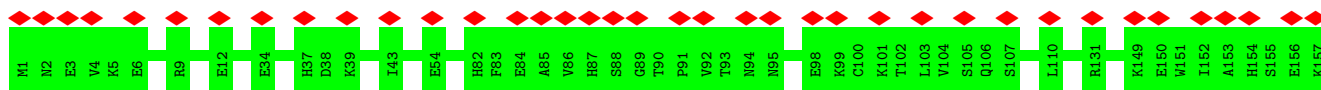

• Molecule 34: Sperm acrosome-associated protein 9

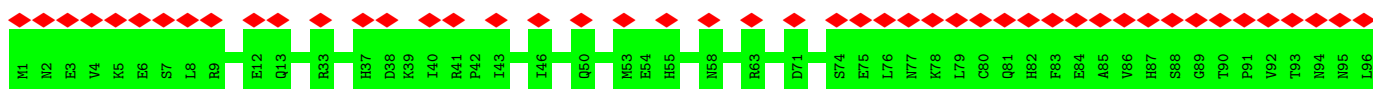
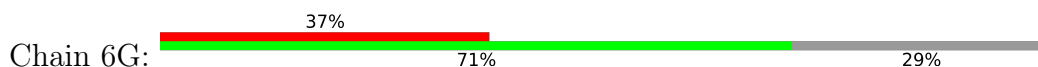

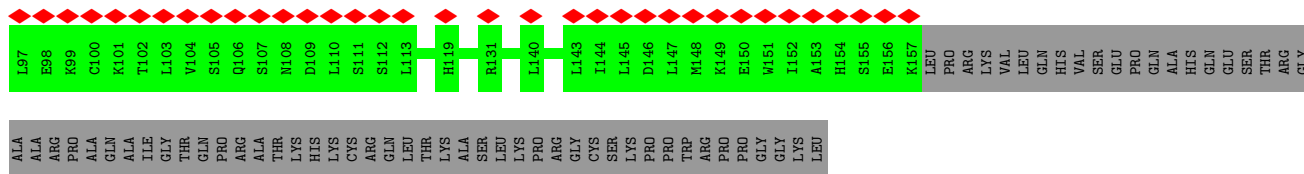

• Molecule 34: Sperm acrosome-associated protein 9

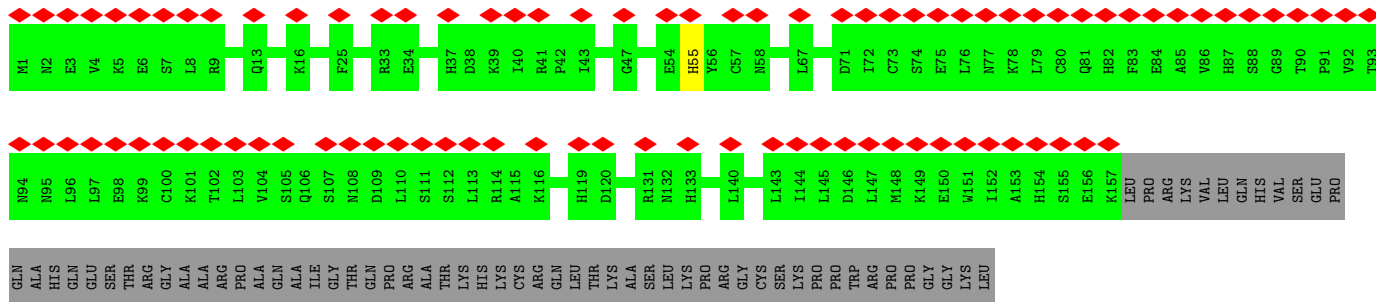
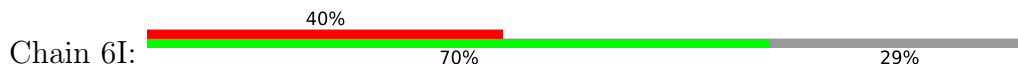

• Molecule 34: Sperm acrosome-associated protein 9

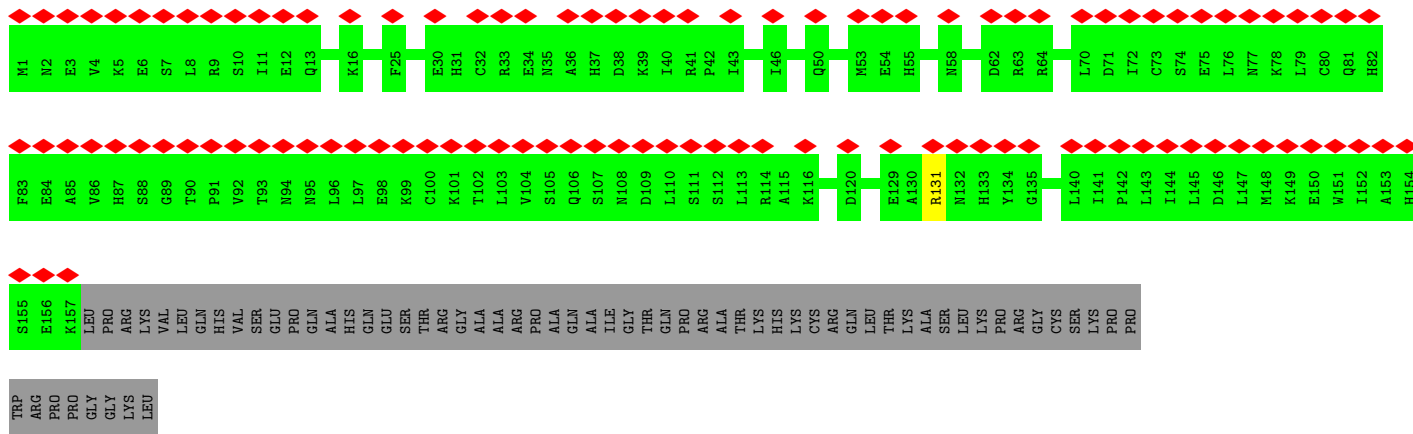
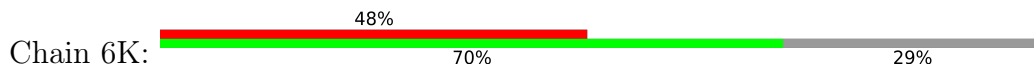

• Molecule 34: Sperm acrosome-associated protein 9

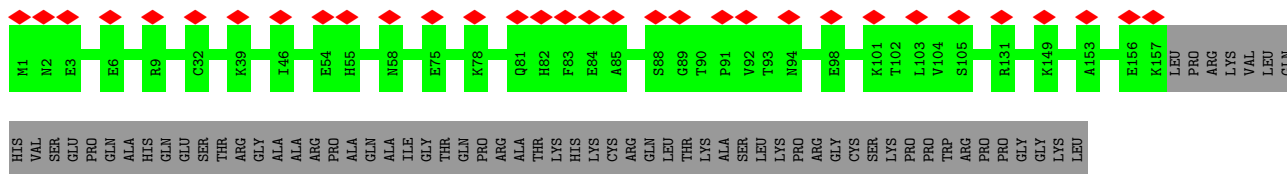
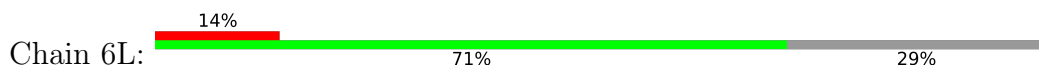

• Molecule 34: Sperm acrosome-associated protein 9

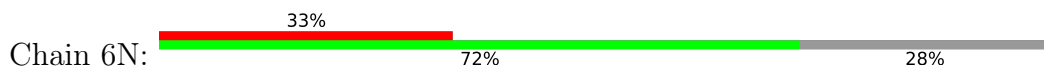

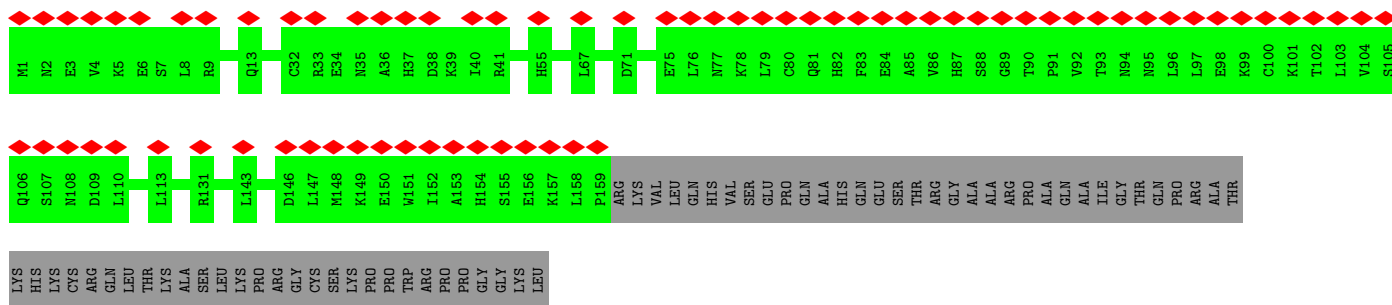

• Molecule 34: Sperm acrosome-associated protein 9

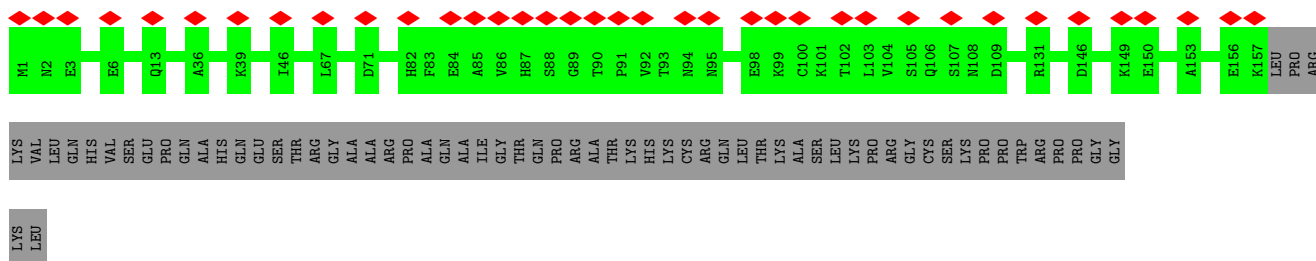
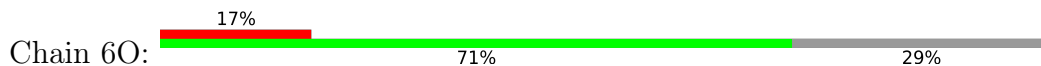

• Molecule 34: Sperm acrosome-associated protein 9

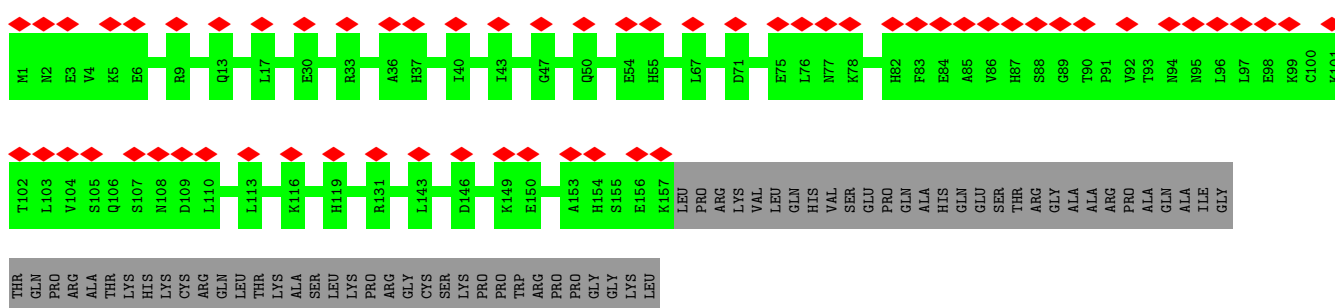
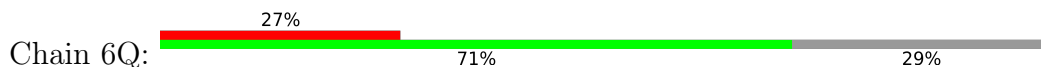

• Molecule 34: Sperm acrosome-associated protein 9

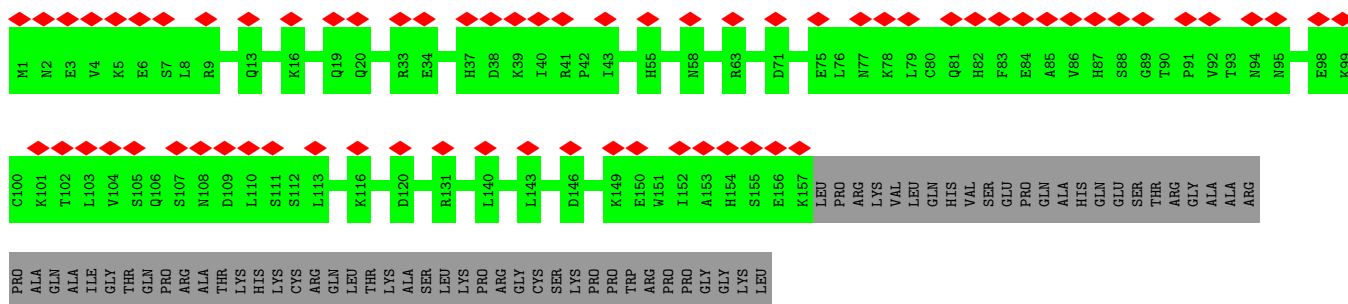

• Molecule 34: Sperm acrosome-associated protein 9

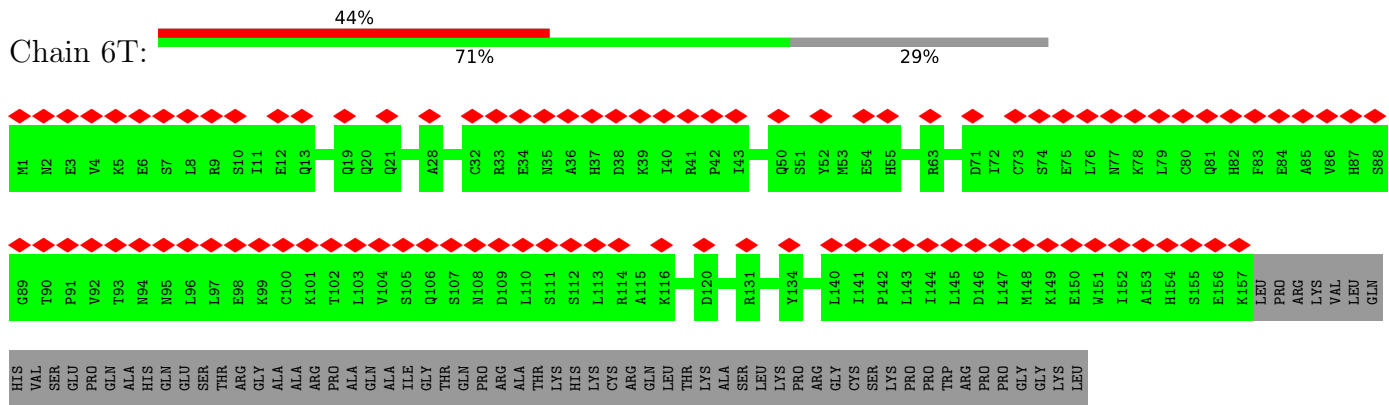

• Molecule 34: Sperm acrosome-associated protein 9

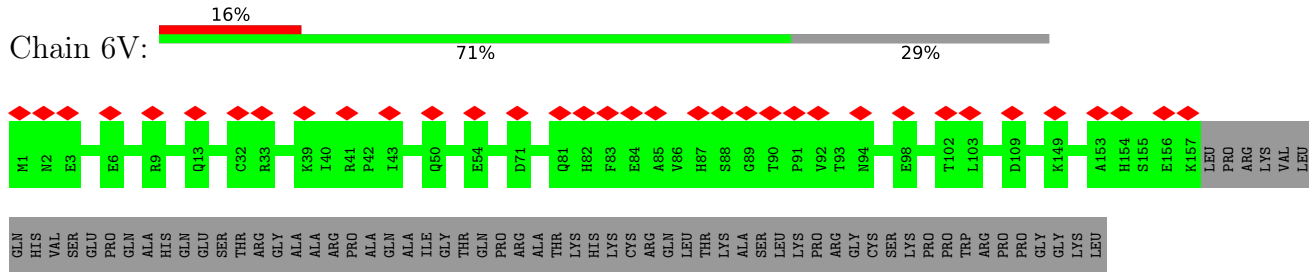

• Molecule 35: Dynein regulatory complex subunit 7

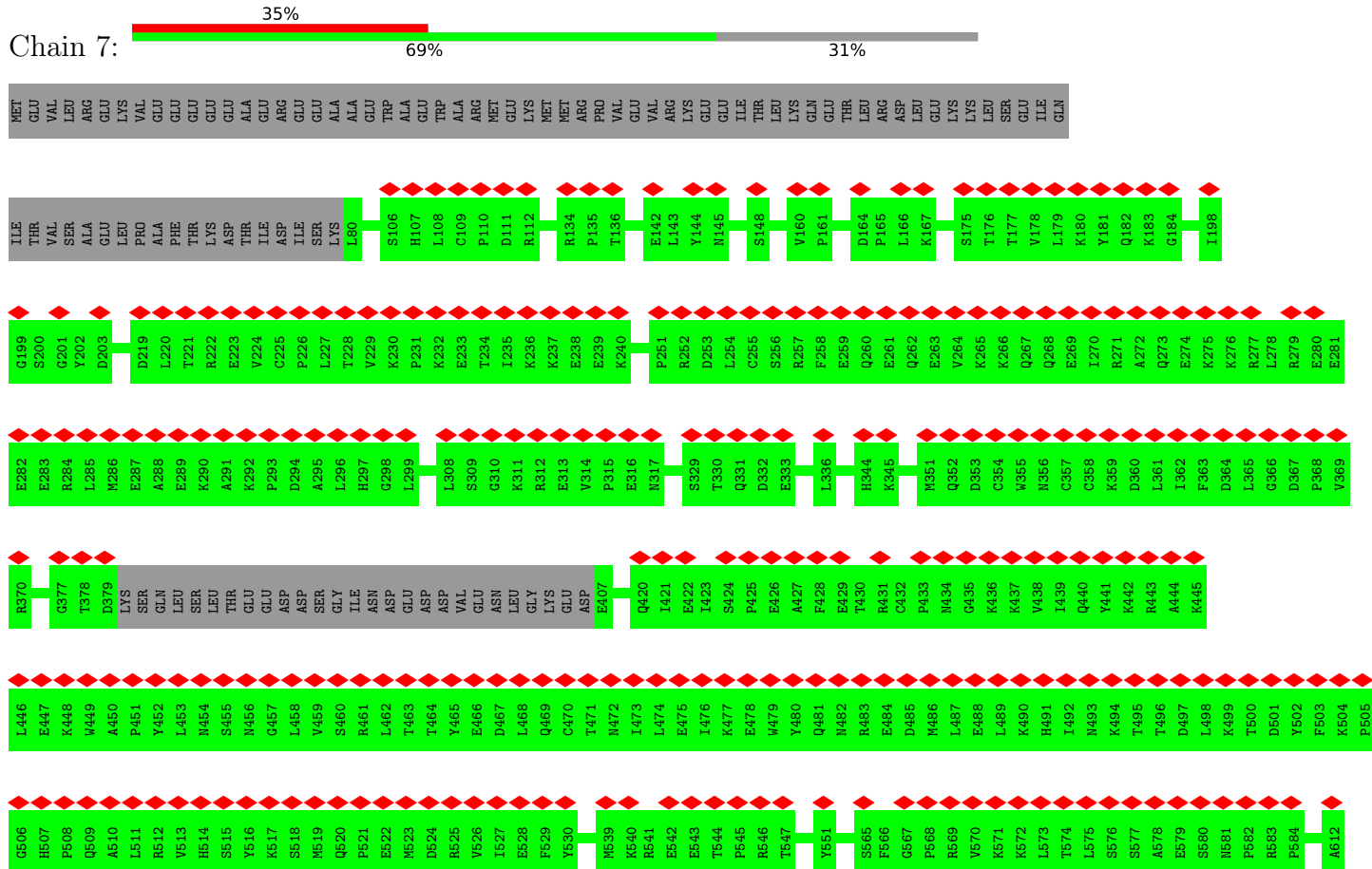

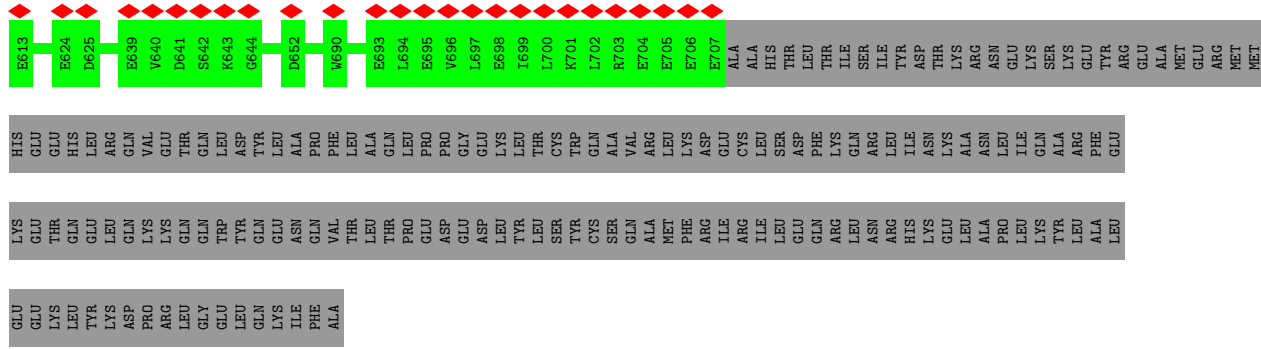

• Molecule 36: Protein FAM166C

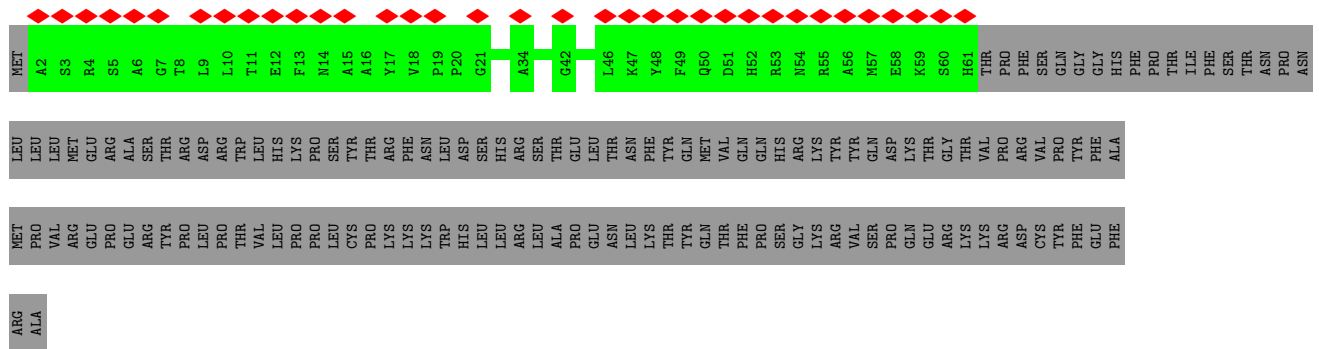

• Molecule 36: Protein FAM166C

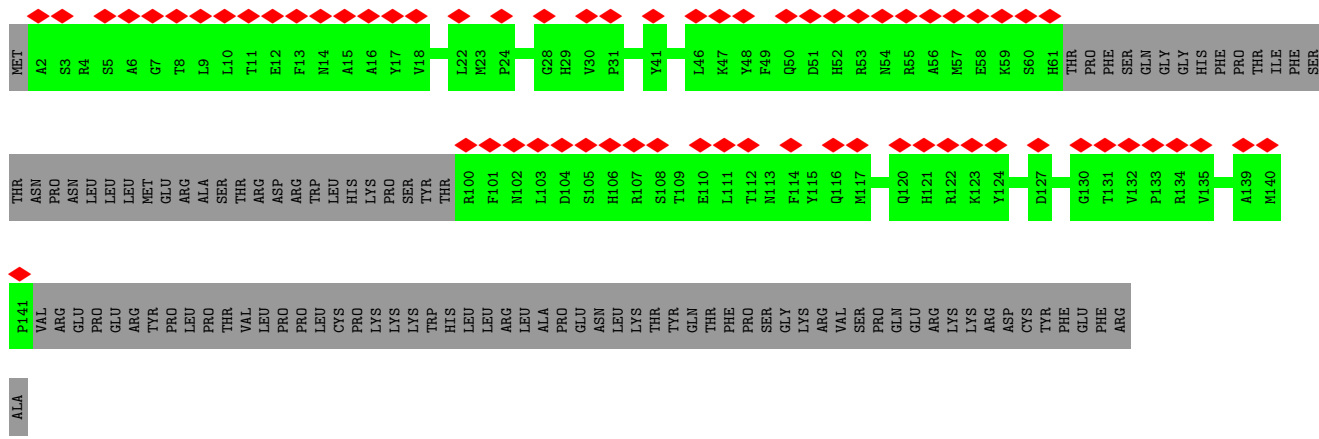

• Molecule 36: Protein FAM166C

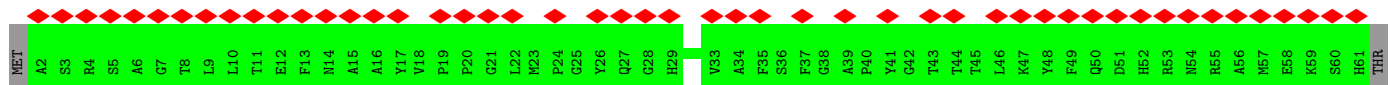
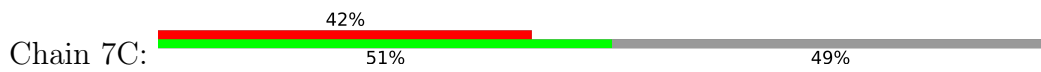

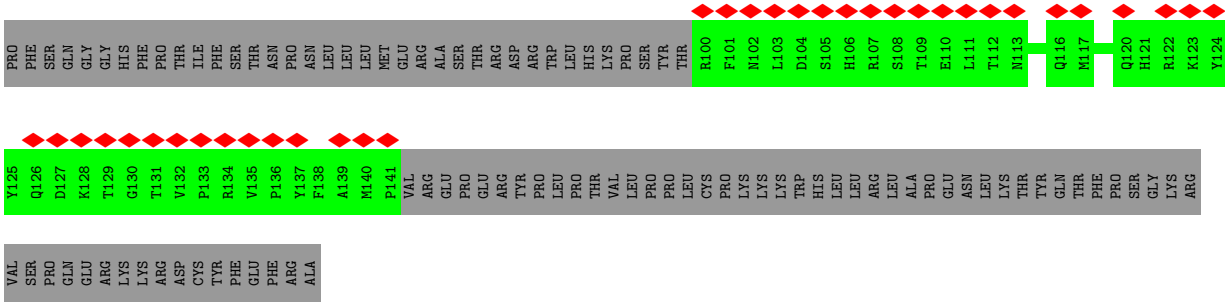

• Molecule 36: Protein FAM166C

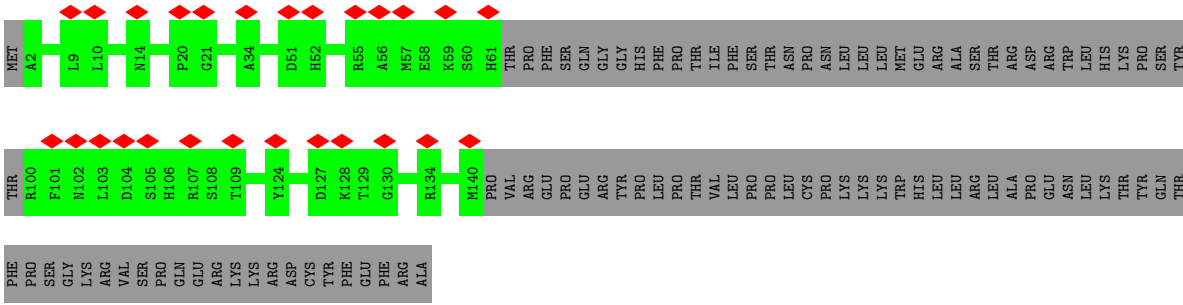

• Molecule 36: Protein FAM166C

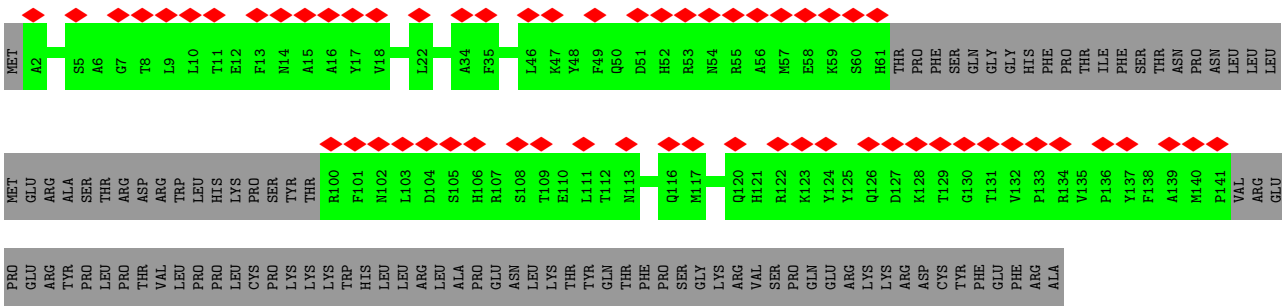

• Molecule 36: Protein FAM166C

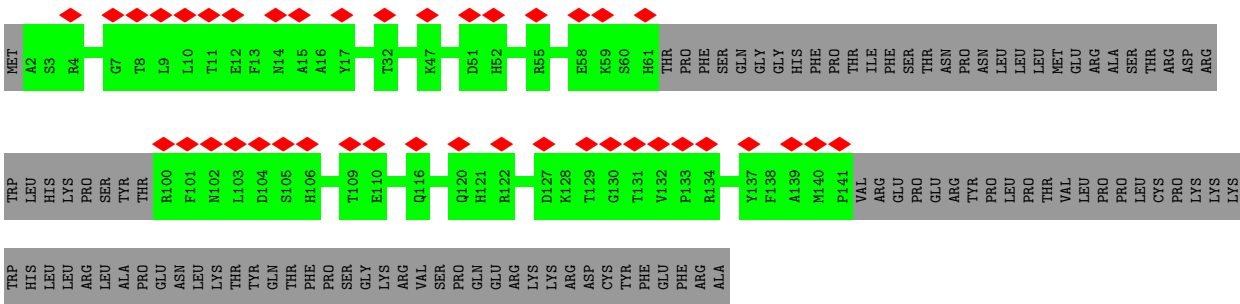

• Molecule 36: Protein FAM166C

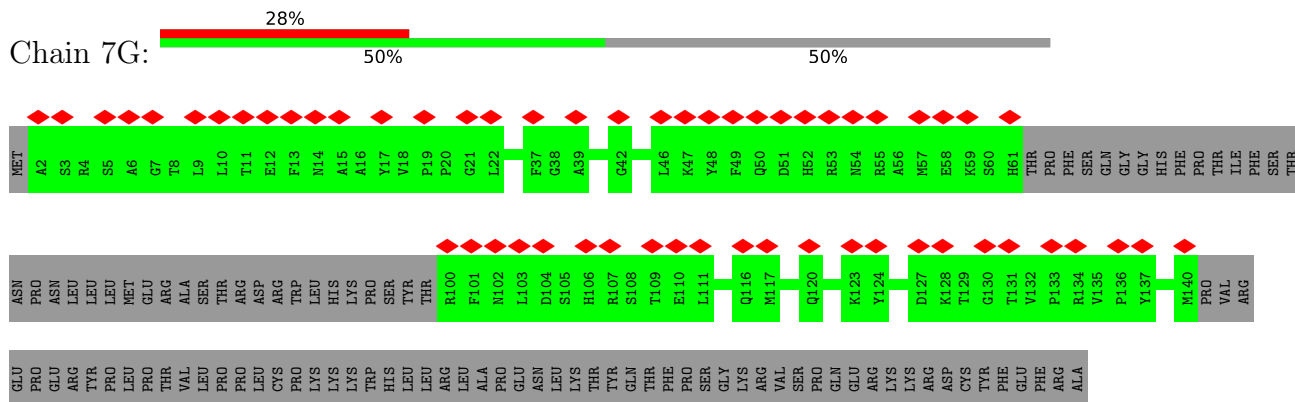

• Molecule 37: Cilia- and flagella-associated protein 144

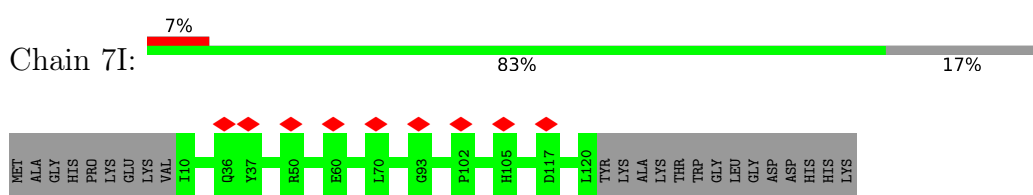

• Molecule 37: Cilia- and flagella-associated protein 144

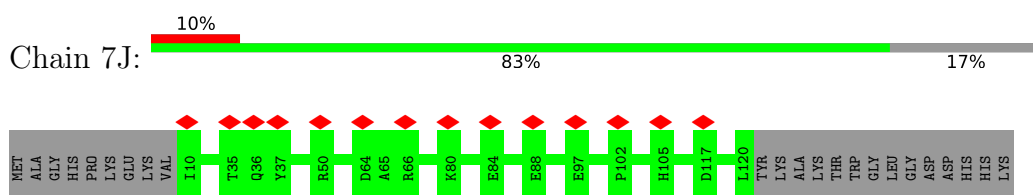

• Molecule 38: Tektin-1

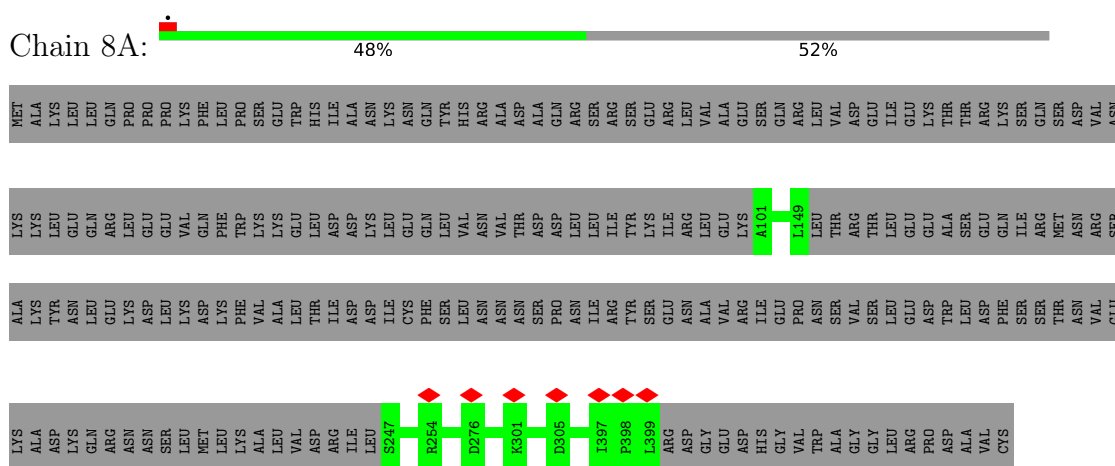

• Molecule 38: Tektin-1

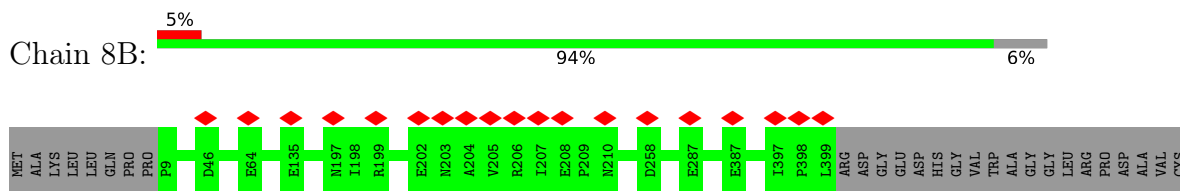

• Molecule 38: Tektin-1

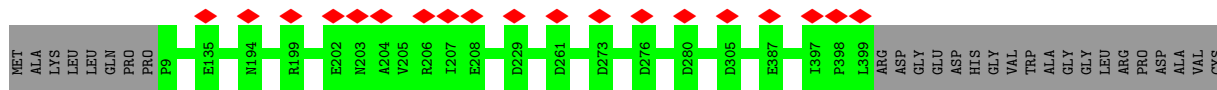

• Molecule 38: Tektin-1

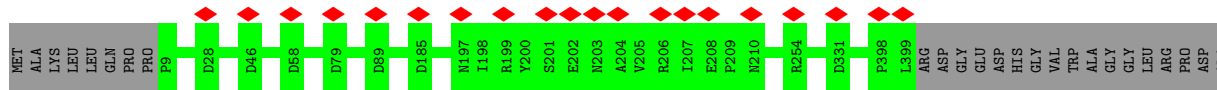

• Molecule 38: Tektin-1

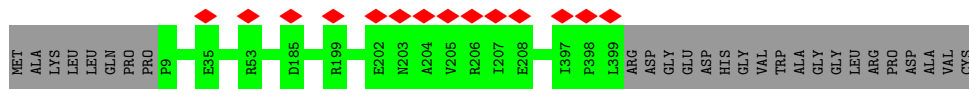

• Molecule 38: Tektin-1

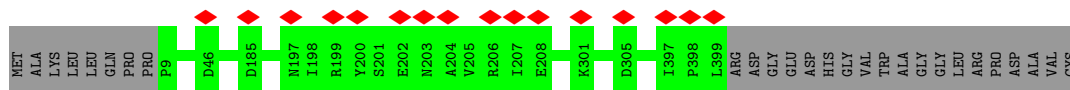

• Molecule 38: Tektin-1

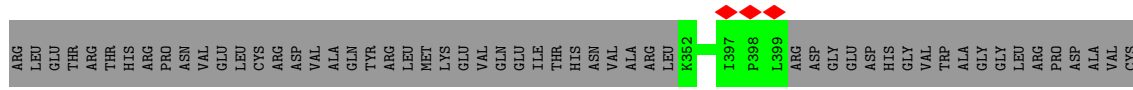
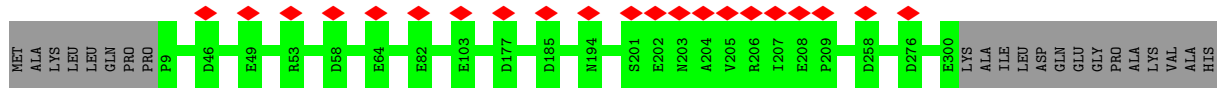
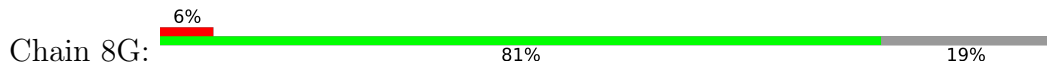

• Molecule 38: Tektin-1

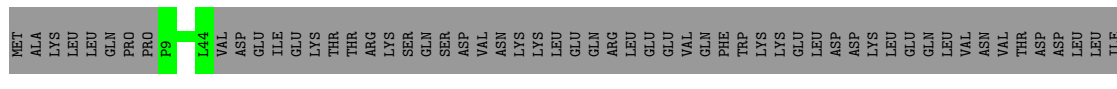

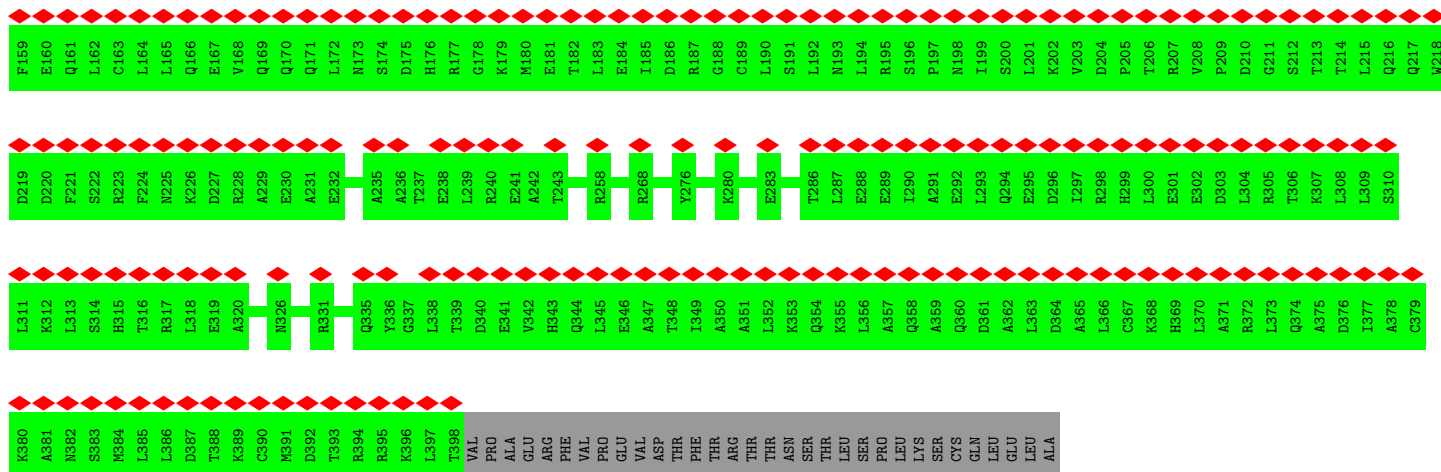

• Molecule 39: Tektin-2

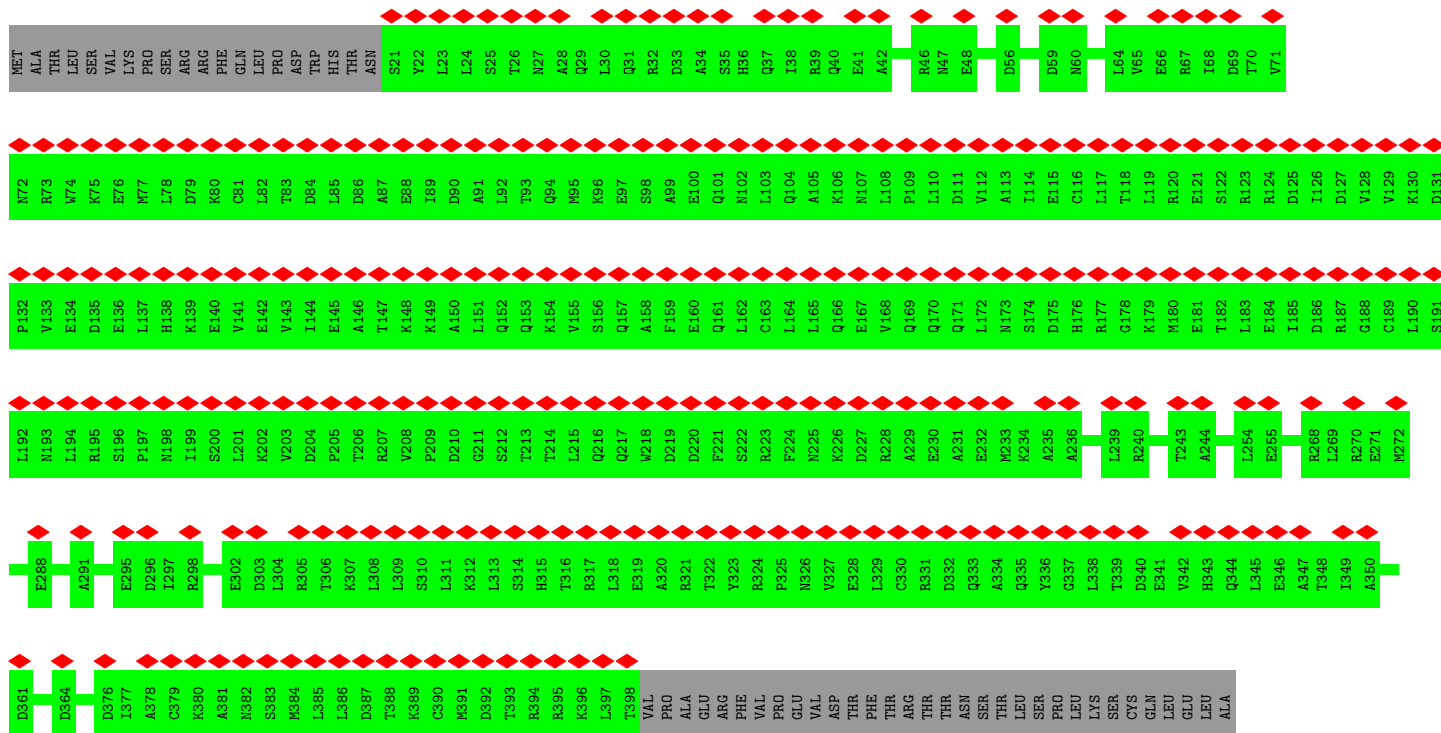
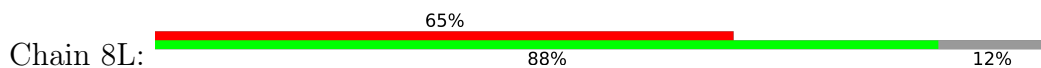

• Molecule 39: Tektin-2

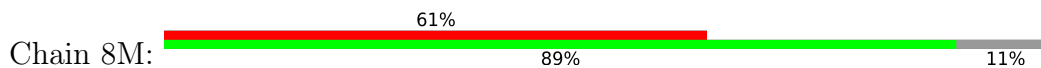

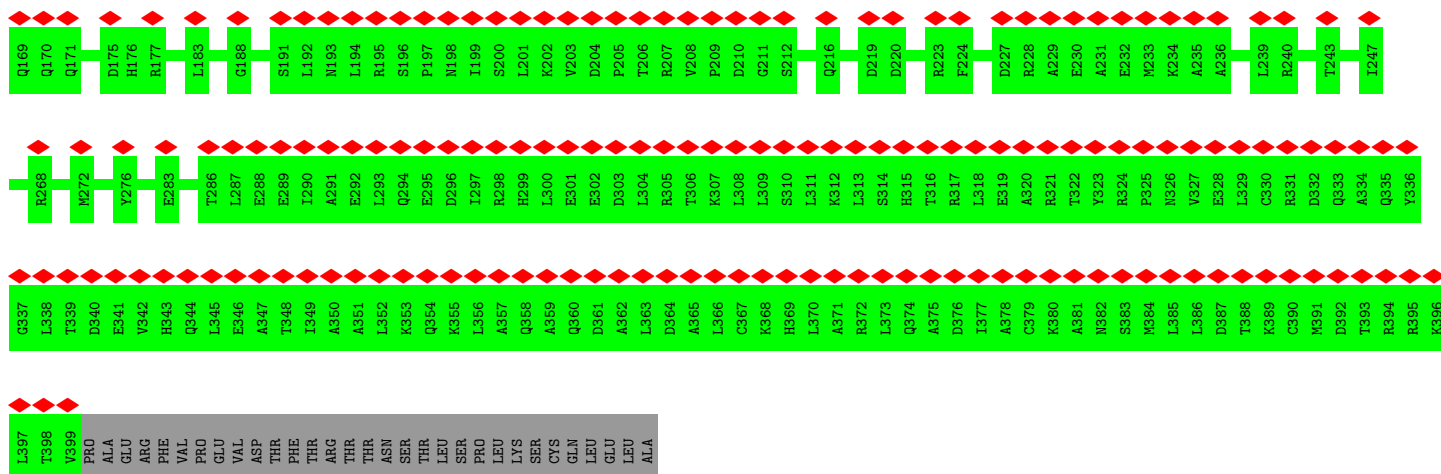

• Molecule 39: Tektin-2

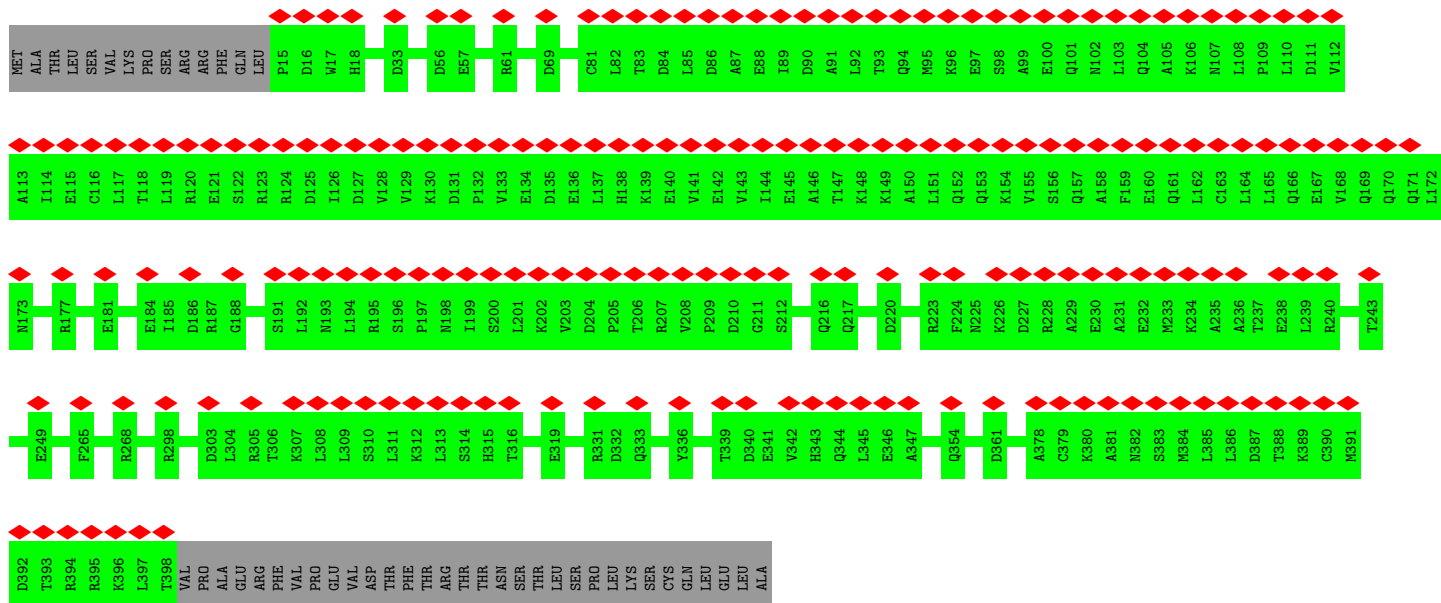
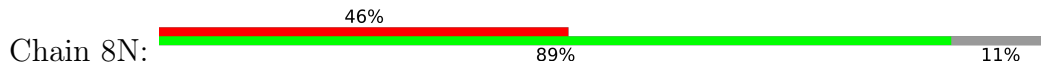

• Molecule 39: Tektin-2

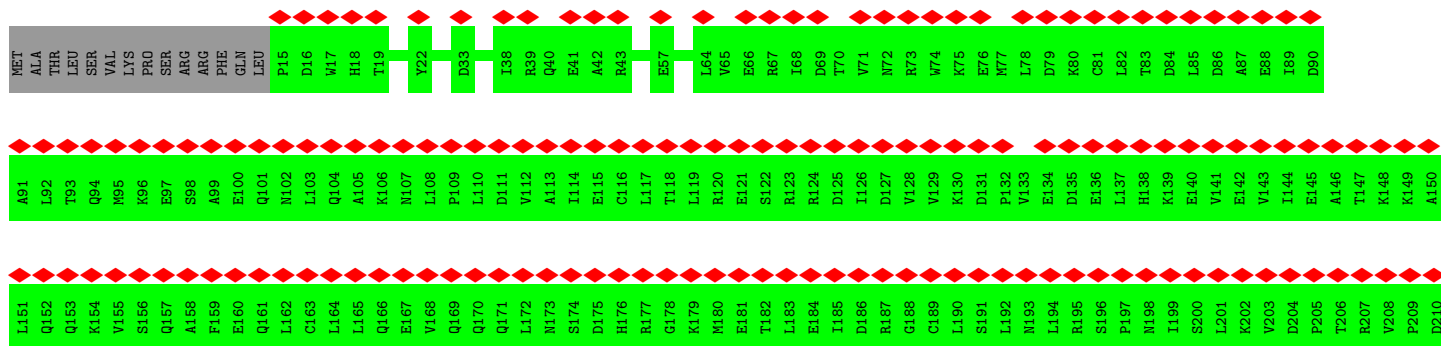
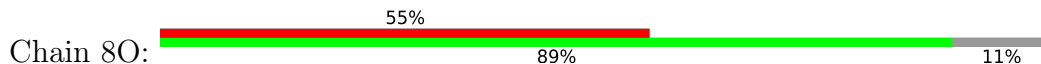

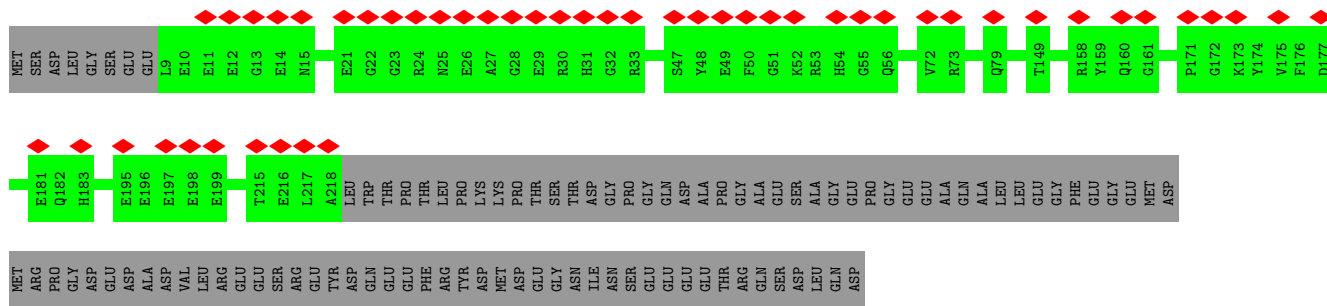

• Molecule 41: Radial spoke head 1 homolog

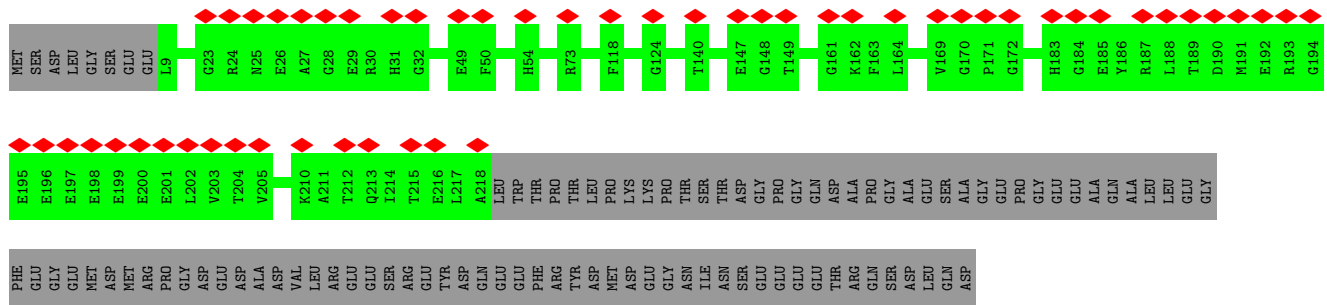

• Molecule 41: Radial spoke head 1 homolog

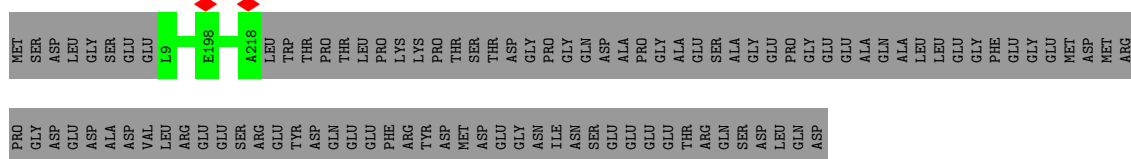

• Molecule 41: Radial spoke head 1 homolog

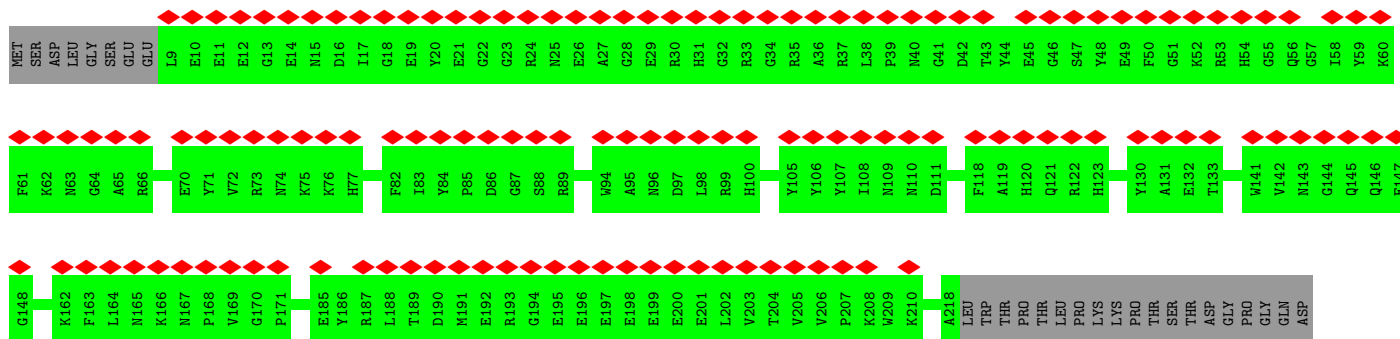
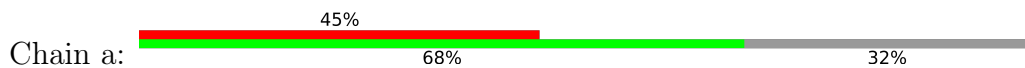

ALA PRO GLY GLY ALA ALA SER SER ALA GLU GLU GLU PRO GLU GLU ALA ALA GLN LEU LEU LEU LEU GLU GLU PHE GLY GLY MET MET ASP MET MET PRO PRO GLY GLY ASP ASP GLU ALA VAL LEU LEU ARG ARG GLU GLU SER SER ARG ARG TYR ASP ASN GLN GLU PHE ARG TYR ASP MET MET ASP ASP GLY ASN ILE ASN SER

GLU
GLU
GLU
THR
ARG
GLN
SER
ASP

- Molecule 41: Radial spoke head 1 homolog

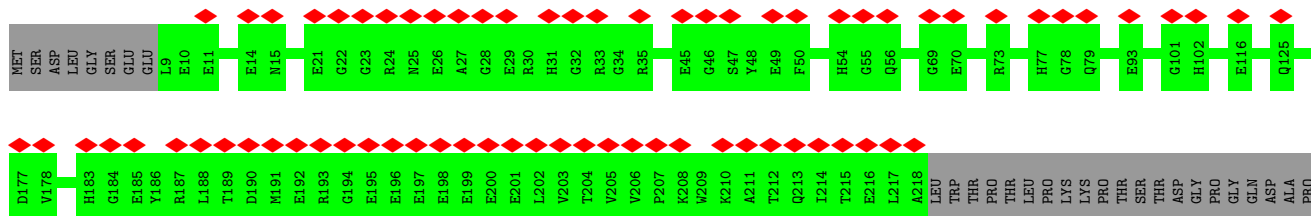

GLY ALA GLU THR ARG SER SER ALA GLY GLU PRO GLU GLY GLU ALA GLN ALA LEU LEU LEU LEU PHE GLY GLU MET MET ARG PRO GLY ASP L202 L203 V204 V205 V206 V207 K208 G209 S210 A211 T212 Q213 I214 T215 E216 L217 A218 LEU TRP THR PRO THR LEU PRO LYS LYS PRO THR SER THR ASP MET ASP GLY ILE ASN SER GLU GLY THR SER THR ASP PRO GLY ALA PRO

GLU
GLU
THR
ARG
SER
GLN
ASP
LEU
GLN
ASP

- Molecule 41: Radial spoke head 1 homolog

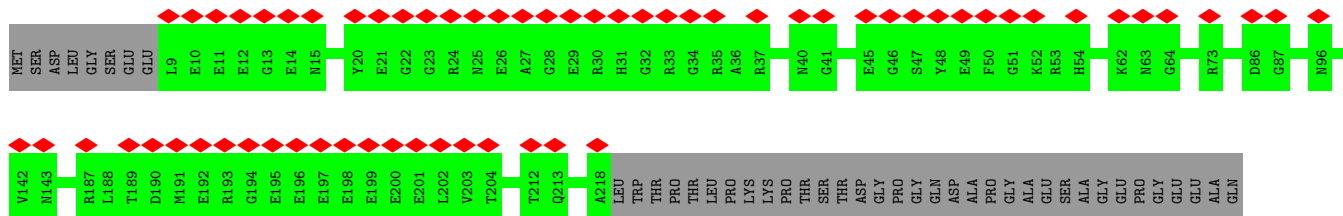

ALA LEU LEU LEU GLY PHE GLU GLY MET ASP MET ARG PRO GLY GLU ASP ALA ASP VAL LEU ARG ARG TYR ASP GLN GLU LEU TRP ARG TYR ASP MET ASP GLY ILE ASN SER LEU LEU GLU GLU THR ARG GLN ASP ASP PRO GLY SER THR THR THR PRO ASP PHE ASP ASP ASP ASP ASP LEU LEU LEU LEU

- Molecule 41: Radial spoke head 1 homolog

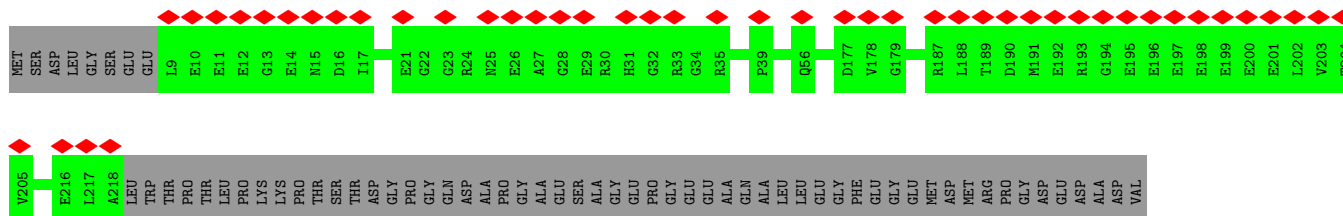

LEU ARG
GLU
SER
ARG
GLY
TYR

- Molecule 42: Tubulin alpha-1A chain

Chain AZ:  97%

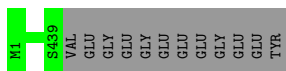

- Molecule 42: Tubulin alpha-1A chain

Chain AC:  97%

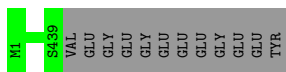

- Molecule 42: Tubulin alpha-1A chain

Chain AE:  97%

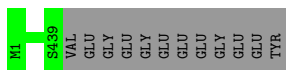

- Molecule 42: Tubulin alpha-1A chain

Chain AG:  97%

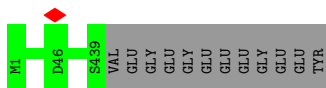

- Molecule 42: Tubulin alpha-1A chain

Chain AI:  97%

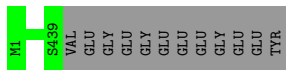

- Molecule 42: Tubulin alpha-1A chain

Chain AK:  97%

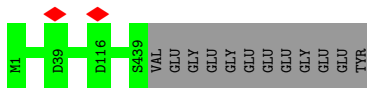

- Molecule 42: Tubulin alpha-1A chain

Chain AM:  97%

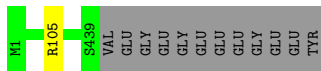

- Molecule 42: Tubulin alpha-1A chain

Chain AO:  97%

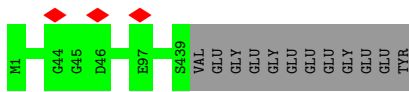

- Molecule 42: Tubulin alpha-1A chain

Chain AQ:  97%

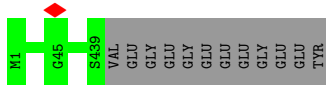

- Molecule 42: Tubulin alpha-1A chain

Chain AS:  97%

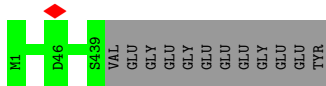

- Molecule 42: Tubulin alpha-1A chain

Chain AU:  97%

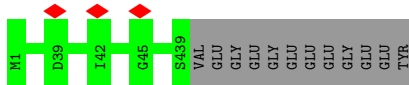

- Molecule 42: Tubulin alpha-1A chain

Chain AW:  97%

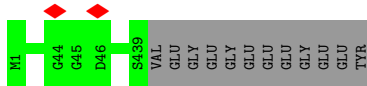

- Molecule 42: Tubulin alpha-1A chain

Chain AY:  97%

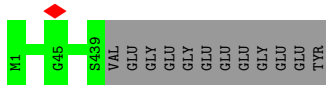

- Molecule 42: Tubulin alpha-1A chain

Chain BA:  97%

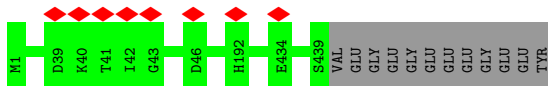

- Molecule 42: Tubulin alpha-1A chain

Chain BC:  97%

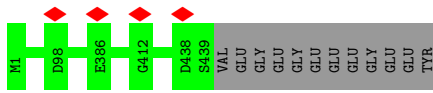

- Molecule 42: Tubulin alpha-1A chain

Chain BE:  96%

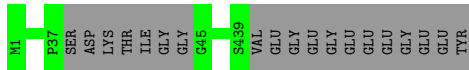

- Molecule 42: Tubulin alpha-1A chain

Chain BG:  97%

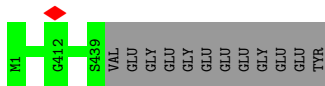

- Molecule 42: Tubulin alpha-1A chain

Chain BI:  96%

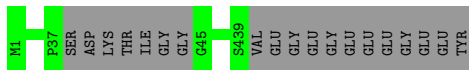

- Molecule 42: Tubulin alpha-1A chain

Chain BK:  97%

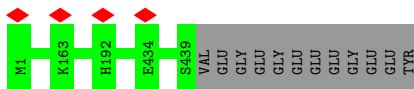

- Molecule 42: Tubulin alpha-1A chain

Chain BM:  96%

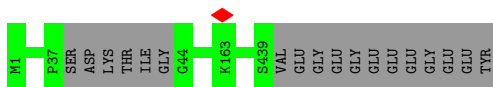

- Molecule 42: Tubulin alpha-1A chain

Chain BO:  97%

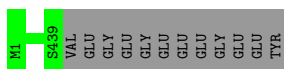

- Molecule 42: Tubulin alpha-1A chain

Chain BQ: 97%

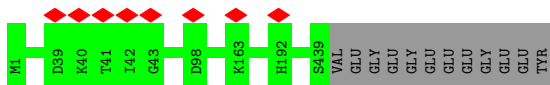

- Molecule 42: Tubulin alpha-1A chain

Chain BS: 97%

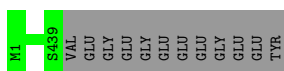

- Molecule 42: Tubulin alpha-1A chain

Chain BU: 97%

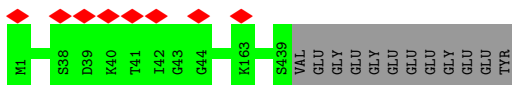

- Molecule 42: Tubulin alpha-1A chain

Chain BW: 97%

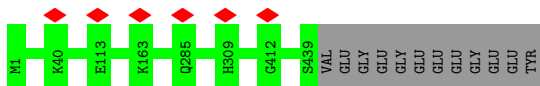

- Molecule 42: Tubulin alpha-1A chain

Chain BY: 96%



- Molecule 42: Tubulin alpha-1A chain

Chain CC: 97%

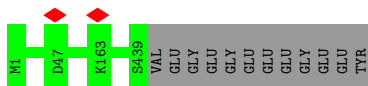

- Molecule 42: Tubulin alpha-1A chain

Chain CE:  95% 5%

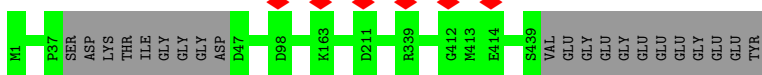

- Molecule 42: Tubulin alpha-1A chain

Chain CG:  97%

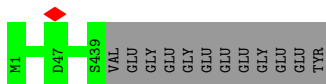

- Molecule 42: Tubulin alpha-1A chain

Chain CI:  96%

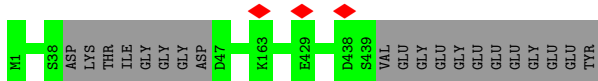

- Molecule 42: Tubulin alpha-1A chain

Chain CK:  97%

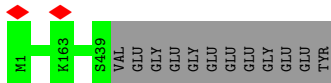

- Molecule 42: Tubulin alpha-1A chain

Chain CM:  95%

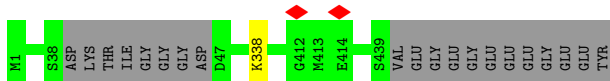

- Molecule 42: Tubulin alpha-1A chain

Chain CO:  97%

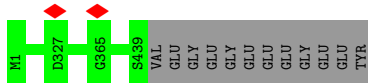

- Molecule 42: Tubulin alpha-1A chain

Chain CQ:  97%

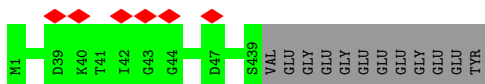

• Molecule 42: Tubulin alpha-1A chain

Chain CS:  97%

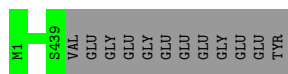

• Molecule 42: Tubulin alpha-1A chain

Chain CU:  97%

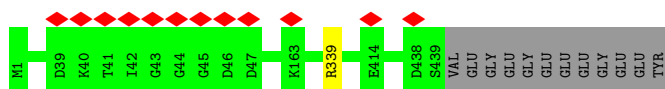

• Molecule 42: Tubulin alpha-1A chain

Chain CW:  96%

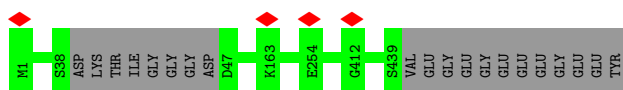

• Molecule 42: Tubulin alpha-1A chain

Chain CY:  97%

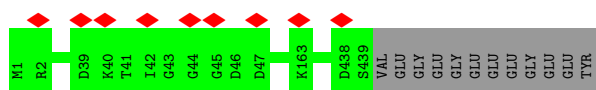

• Molecule 42: Tubulin alpha-1A chain

Chain DC:  95% 5%

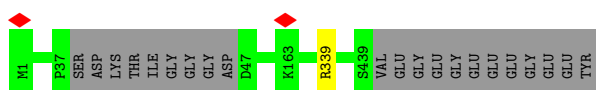

• Molecule 42: Tubulin alpha-1A chain

Chain DE:  96%

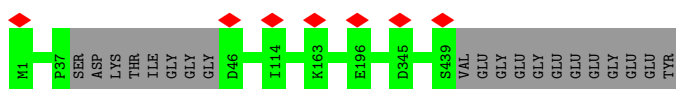

• Molecule 42: Tubulin alpha-1A chain

Chain DG:  95% 5%

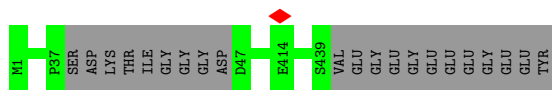

- Molecule 42: Tubulin alpha-1A chain

Chain DI: 95% 5%

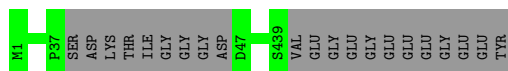

- Molecule 42: Tubulin alpha-1A chain

Chain DK: 95% 5%

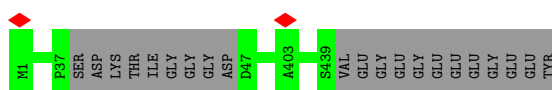

- Molecule 42: Tubulin alpha-1A chain

Chain DM: 96% .

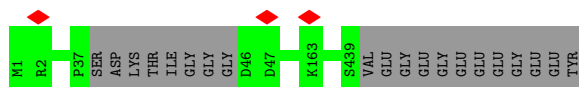

- Molecule 42: Tubulin alpha-1A chain

Chain DO: 96% .

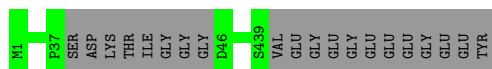

- Molecule 42: Tubulin alpha-1A chain

Chain DQ: 95% 5%

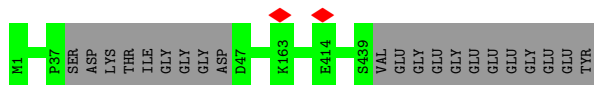

- Molecule 42: Tubulin alpha-1A chain

Chain DS: 96% .

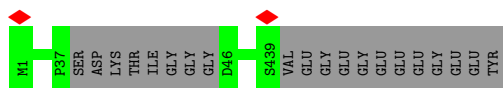

- Molecule 42: Tubulin alpha-1A chain

Chain DU:  95% 5%



- Molecule 42: Tubulin alpha-1A chain

Chain DW:  95% 5%



- Molecule 42: Tubulin alpha-1A chain

Chain DY:  95% 5%

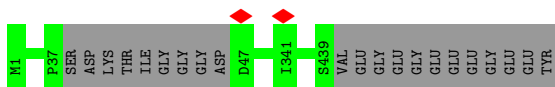

- Molecule 42: Tubulin alpha-1A chain

Chain EC:  97% .

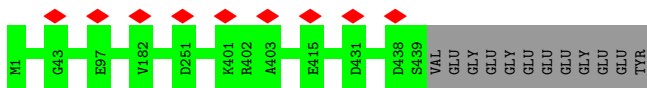

- Molecule 42: Tubulin alpha-1A chain

Chain EE:  97% .

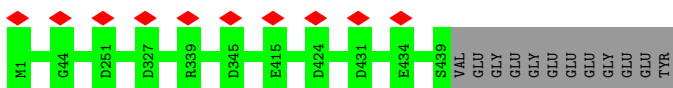

- Molecule 42: Tubulin alpha-1A chain

Chain EG:  97% .

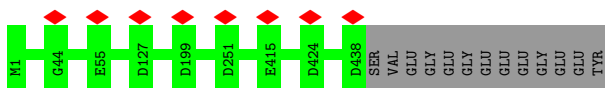

- Molecule 42: Tubulin alpha-1A chain

Chain EI:  97% .

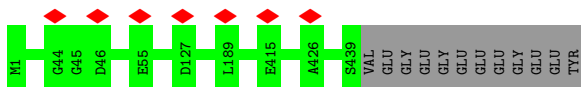

• Molecule 42: Tubulin alpha-1A chain

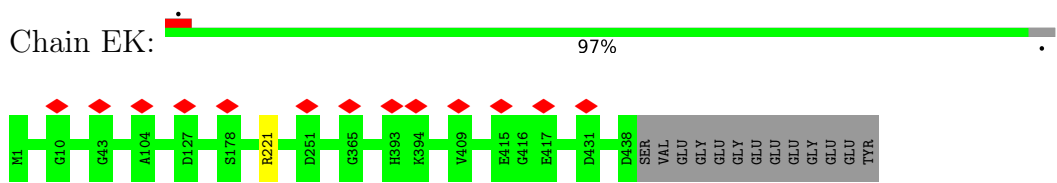

• Molecule 42: Tubulin alpha-1A chain

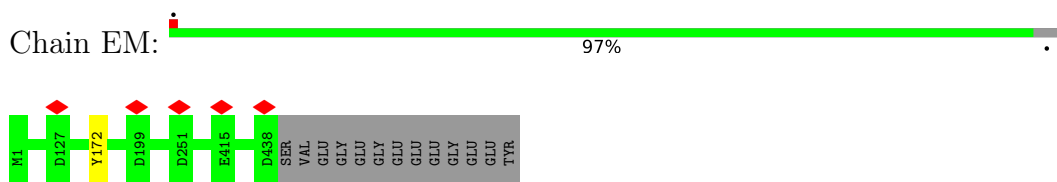

• Molecule 42: Tubulin alpha-1A chain

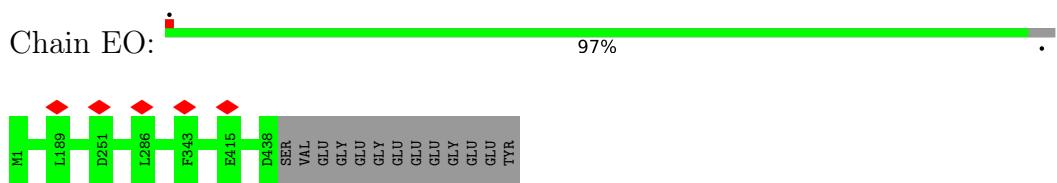

• Molecule 42: Tubulin alpha-1A chain

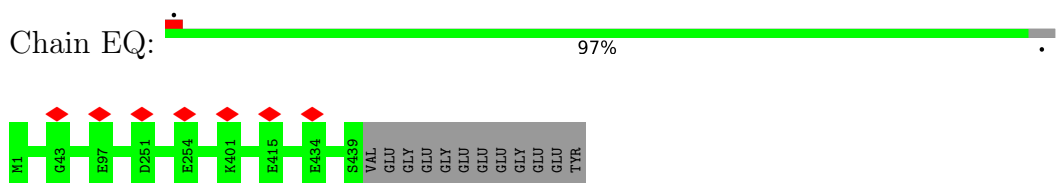

• Molecule 42: Tubulin alpha-1A chain

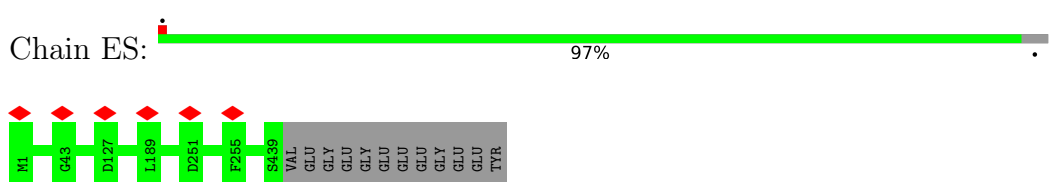

• Molecule 42: Tubulin alpha-1A chain

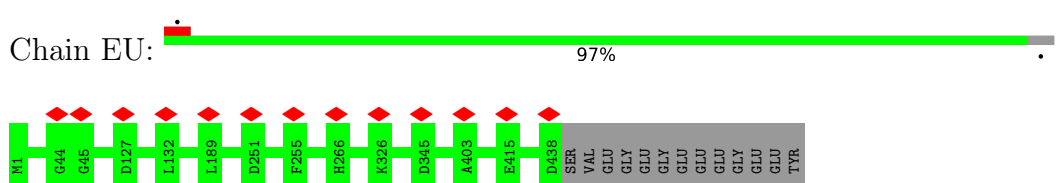

• Molecule 42: Tubulin alpha-1A chain



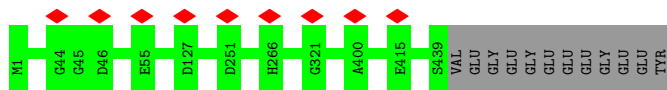

• Molecule 42: Tubulin alpha-1A chain

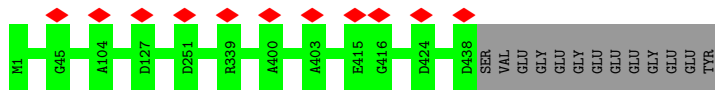

• Molecule 42: Tubulin alpha-1A chain

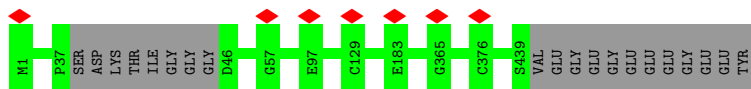

• Molecule 42: Tubulin alpha-1A chain

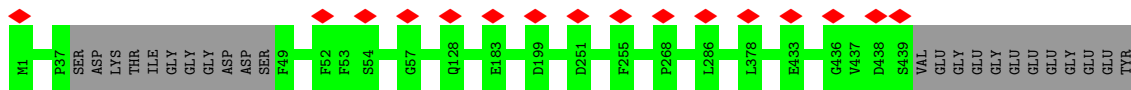

• Molecule 42: Tubulin alpha-1A chain

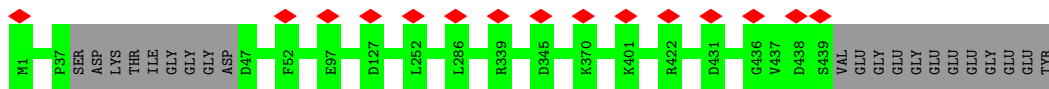

• Molecule 42: Tubulin alpha-1A chain

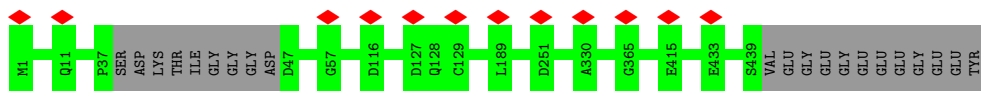

• Molecule 42: Tubulin alpha-1A chain

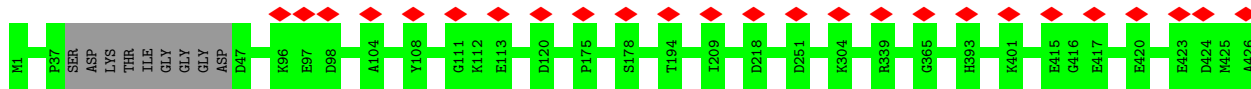

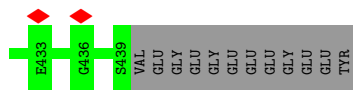

• Molecule 42: Tubulin alpha-1A chain

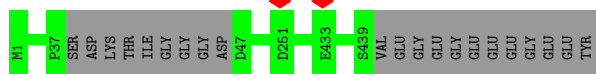

• Molecule 42: Tubulin alpha-1A chain

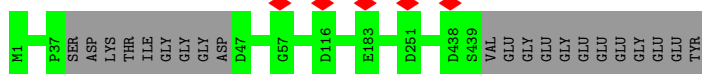

• Molecule 42: Tubulin alpha-1A chain

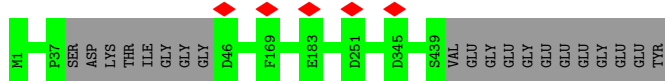

• Molecule 42: Tubulin alpha-1A chain

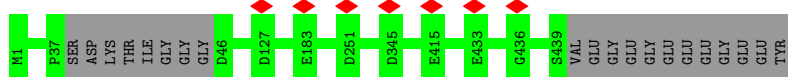

• Molecule 42: Tubulin alpha-1A chain

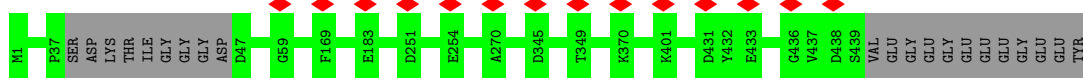

• Molecule 42: Tubulin alpha-1A chain

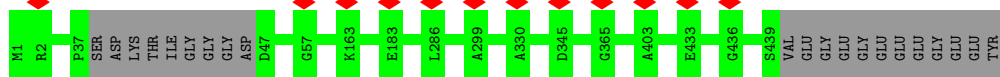

• Molecule 42: Tubulin alpha-1A chain

Chain FY:  95% 5%

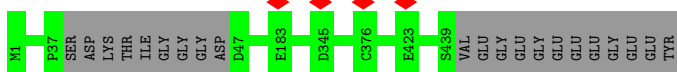

- Molecule 42: Tubulin alpha-1A chain

Chain GC:  96% .

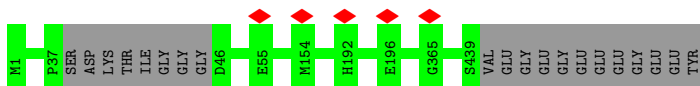

- Molecule 42: Tubulin alpha-1A chain

Chain GE:  96% .

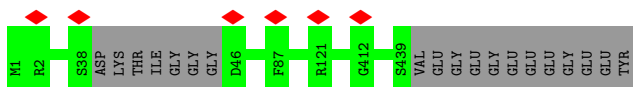

- Molecule 42: Tubulin alpha-1A chain

Chain GG:  95% 5%

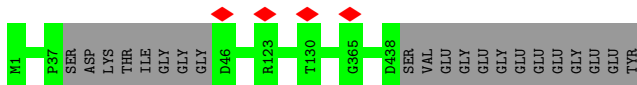

- Molecule 42: Tubulin alpha-1A chain

Chain GI:  96% .

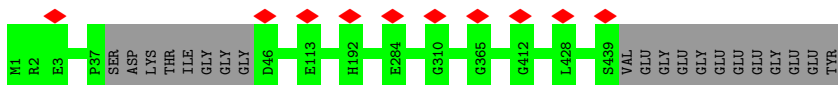

- Molecule 42: Tubulin alpha-1A chain

Chain GK:  96% .

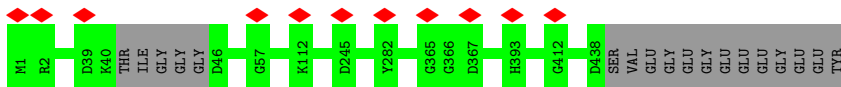

- Molecule 42: Tubulin alpha-1A chain

Chain GM:  95% 5%

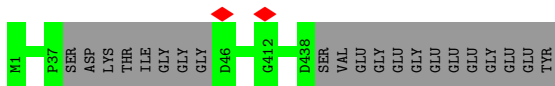

• Molecule 42: Tubulin alpha-1A chain

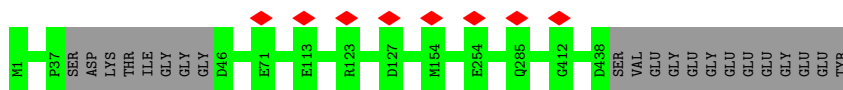

• Molecule 42: Tubulin alpha-1A chain

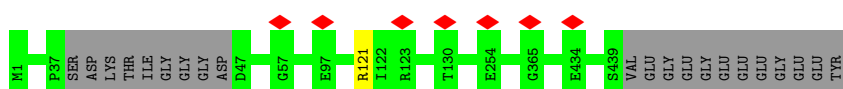

• Molecule 42: Tubulin alpha-1A chain

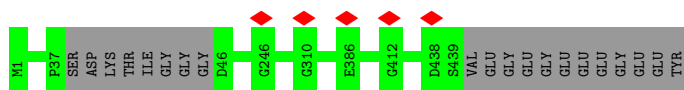

• Molecule 42: Tubulin alpha-1A chain

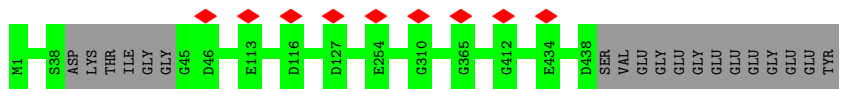

• Molecule 42: Tubulin alpha-1A chain

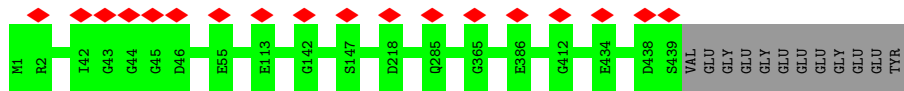

• Molecule 42: Tubulin alpha-1A chain

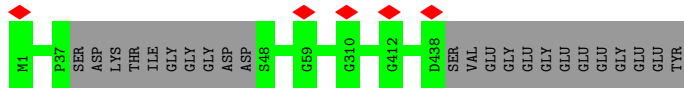

• Molecule 42: Tubulin alpha-1A chain



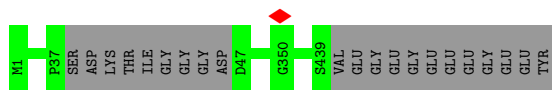

• Molecule 42: Tubulin alpha-1A chain

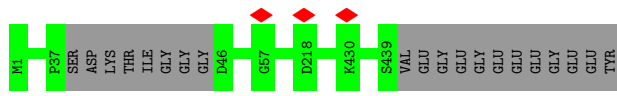

• Molecule 42: Tubulin alpha-1A chain

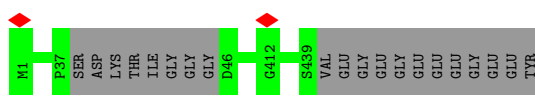
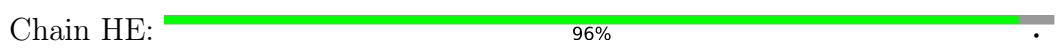

• Molecule 42: Tubulin alpha-1A chain

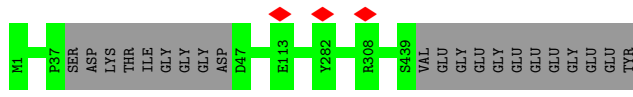

• Molecule 42: Tubulin alpha-1A chain

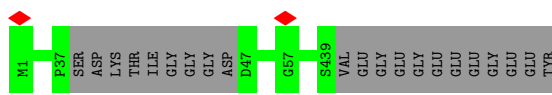

• Molecule 42: Tubulin alpha-1A chain

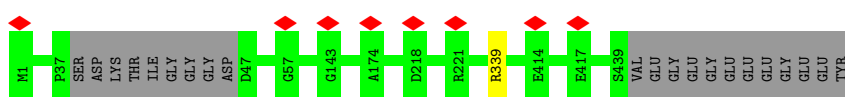

• Molecule 42: Tubulin alpha-1A chain

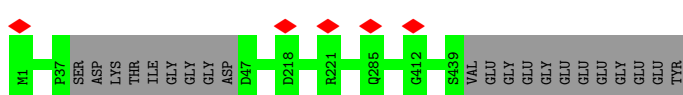

• Molecule 42: Tubulin alpha-1A chain

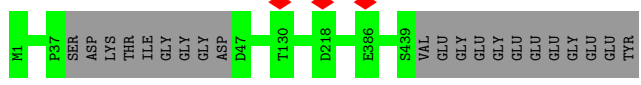

• Molecule 42: Tubulin alpha-1A chain

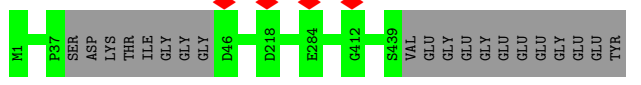

• Molecule 42: Tubulin alpha-1A chain

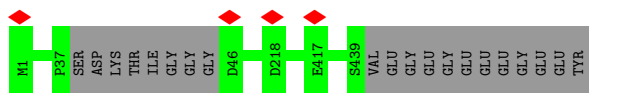

• Molecule 42: Tubulin alpha-1A chain

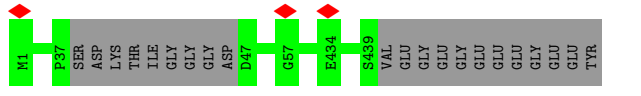

• Molecule 42: Tubulin alpha-1A chain

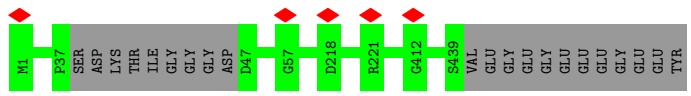

• Molecule 42: Tubulin alpha-1A chain

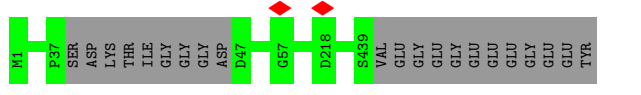

• Molecule 42: Tubulin alpha-1A chain

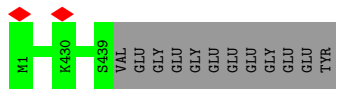

- Molecule 42: Tubulin alpha-1A chain

Chain IC:  96%

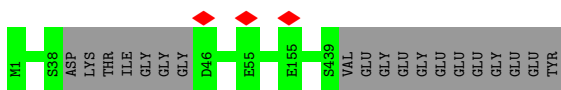

- Molecule 42: Tubulin alpha-1A chain

Chain IE:  97%

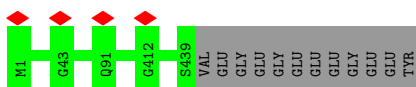

- Molecule 42: Tubulin alpha-1A chain

Chain IG:  97%

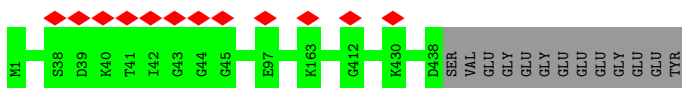

- Molecule 42: Tubulin alpha-1A chain

Chain II:  96%

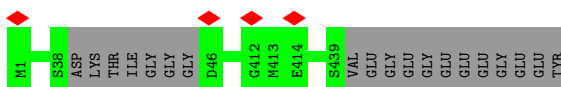

- Molecule 42: Tubulin alpha-1A chain

Chain IK:  95% 5%

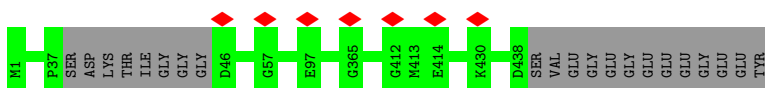

- Molecule 42: Tubulin alpha-1A chain

Chain IM:  97%



- Molecule 42: Tubulin alpha-1A chain

Chain IO:  96%

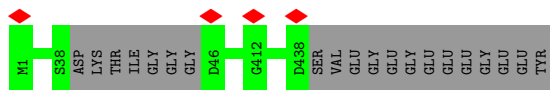

• Molecule 42: Tubulin alpha-1A chain

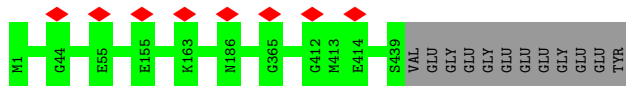

• Molecule 42: Tubulin alpha-1A chain

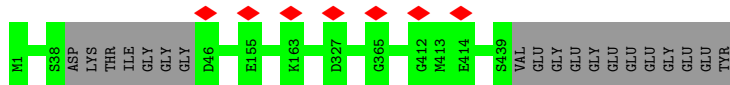

• Molecule 42: Tubulin alpha-1A chain



• Molecule 42: Tubulin alpha-1A chain

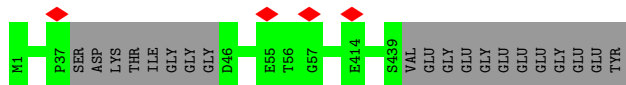

• Molecule 42: Tubulin alpha-1A chain

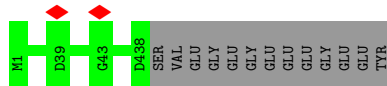

• Molecule 42: Tubulin alpha-1A chain

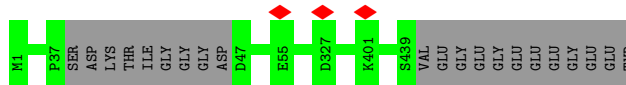

• Molecule 42: Tubulin alpha-1A chain

Chain JE:  96%

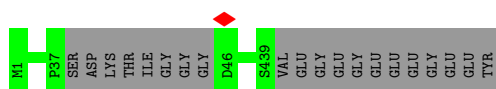

- Molecule 42: Tubulin alpha-1A chain

Chain JG:  96%

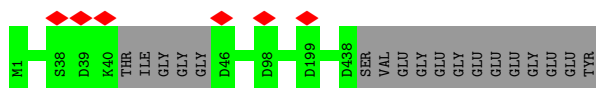

- Molecule 42: Tubulin alpha-1A chain

Chain JI:  96%

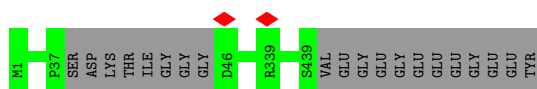

- Molecule 42: Tubulin alpha-1A chain

Chain JK:  95% 5%

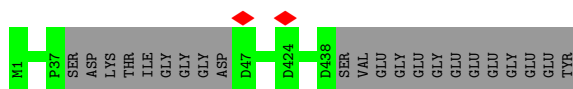

- Molecule 42: Tubulin alpha-1A chain

Chain JM:  95% 5%

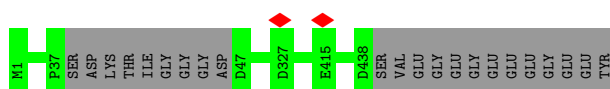

- Molecule 42: Tubulin alpha-1A chain

Chain JO:  95% 5%

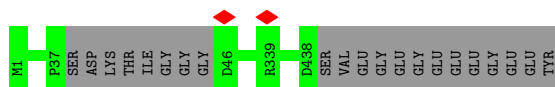

- Molecule 42: Tubulin alpha-1A chain

Chain JQ:  95% 5%

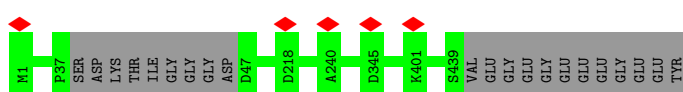

- Molecule 42: Tubulin alpha-1A chain

Chain JS:  96%

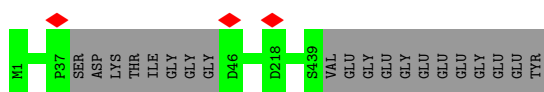

- Molecule 42: Tubulin alpha-1A chain

Chain JU:  95% 5%

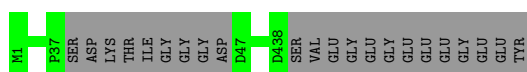

- Molecule 42: Tubulin alpha-1A chain

Chain JW:  96%

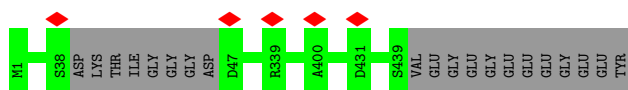

- Molecule 42: Tubulin alpha-1A chain

Chain JY:  95% 5%

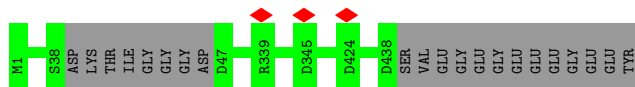

- Molecule 42: Tubulin alpha-1A chain

Chain KC:  96%

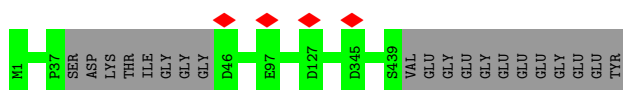

- Molecule 42: Tubulin alpha-1A chain

Chain KE:  96%

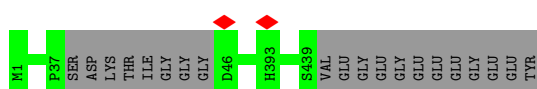

- Molecule 42: Tubulin alpha-1A chain

Chain KG:  95% 5%

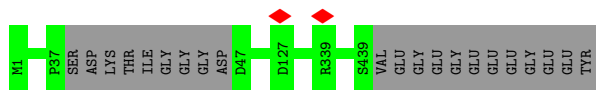

- Molecule 42: Tubulin alpha-1A chain

Chain KI: 95% 5%

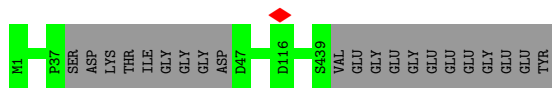

- Molecule 42: Tubulin alpha-1A chain

Chain KK: 95% 5%



- Molecule 42: Tubulin alpha-1A chain

Chain KM: 95% 5%

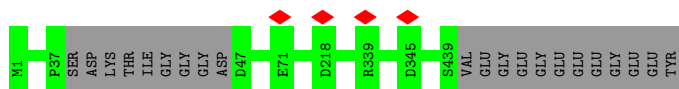

- Molecule 42: Tubulin alpha-1A chain

Chain KO: 95% 5%

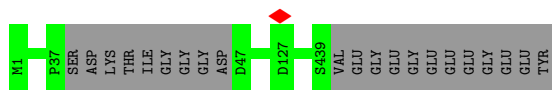

- Molecule 42: Tubulin alpha-1A chain

Chain KQ: 96% 5%

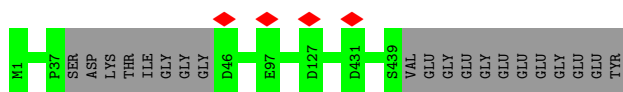

- Molecule 42: Tubulin alpha-1A chain

Chain KS: 95% 5%

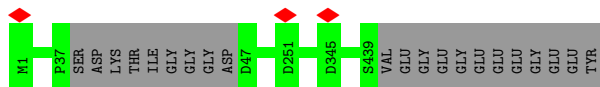

- Molecule 42: Tubulin alpha-1A chain

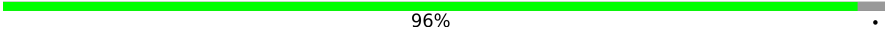
Chain KU:  96%

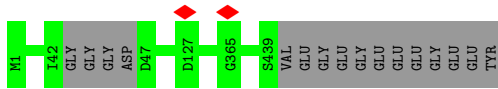

- Molecule 42: Tubulin alpha-1A chain

Chain KW:  95% 5%

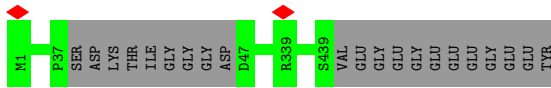

- Molecule 42: Tubulin alpha-1A chain

Chain KY:  95% 5%

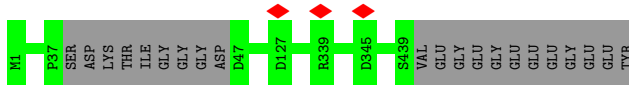

- Molecule 42: Tubulin alpha-1A chain

Chain LC:  96%

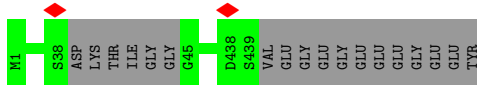

- Molecule 42: Tubulin alpha-1A chain

Chain LE:  96%

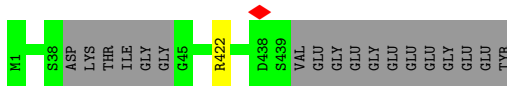

- Molecule 42: Tubulin alpha-1A chain

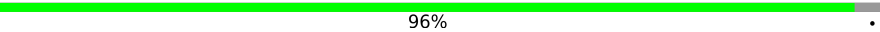
Chain LG:  96%

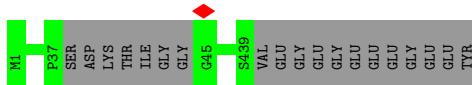

- Molecule 42: Tubulin alpha-1A chain

Chain LI:  96%

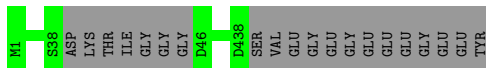

• Molecule 42: Tubulin alpha-1A chain

Chain LK:  96%

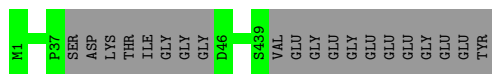

• Molecule 42: Tubulin alpha-1A chain

Chain LM:  97%

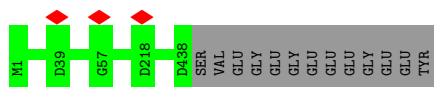

• Molecule 42: Tubulin alpha-1A chain

Chain LO:  97%

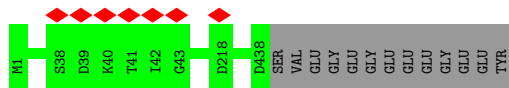

• Molecule 42: Tubulin alpha-1A chain

Chain LQ:  97%

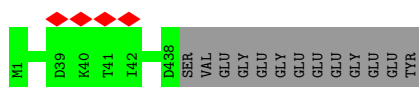

• Molecule 42: Tubulin alpha-1A chain

Chain LS:  97%

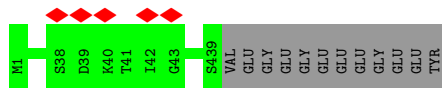

• Molecule 42: Tubulin alpha-1A chain

Chain LU:  96%

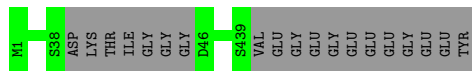

• Molecule 42: Tubulin alpha-1A chain

Chain LW:  96%

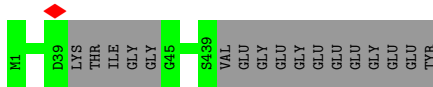

- Molecule 42: Tubulin alpha-1A chain

Chain LY: 97%

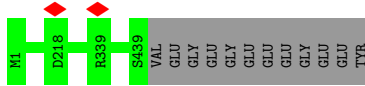

- Molecule 42: Tubulin alpha-1A chain

Chain MA: 95% 5%

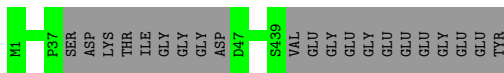

- Molecule 42: Tubulin alpha-1A chain

Chain MC: 96%

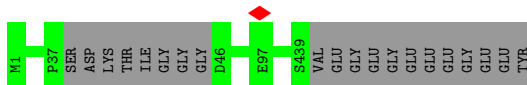

- Molecule 42: Tubulin alpha-1A chain

Chain ME: 96%

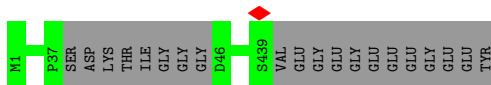

- Molecule 42: Tubulin alpha-1A chain

Chain MG: 95% 5%

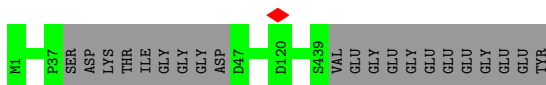

- Molecule 42: Tubulin alpha-1A chain

Chain MI: 95% 5%

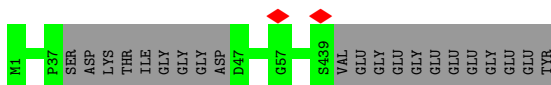

- Molecule 42: Tubulin alpha-1A chain

Chain MK:  95% 5%

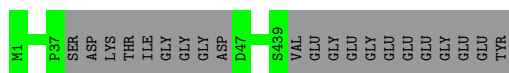

- Molecule 42: Tubulin alpha-1A chain

Chain MM:  95% 5%

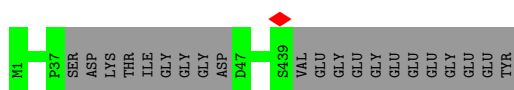

- Molecule 42: Tubulin alpha-1A chain

Chain MO:  95% 5%

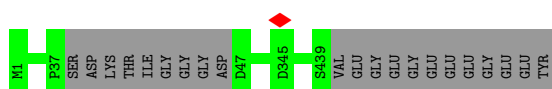

- Molecule 42: Tubulin alpha-1A chain

Chain MQ:  96% 5%

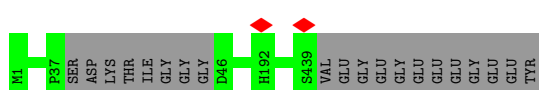

- Molecule 42: Tubulin alpha-1A chain

Chain MS:  96% 5%

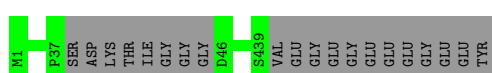

- Molecule 42: Tubulin alpha-1A chain

Chain MU:  95% 5%

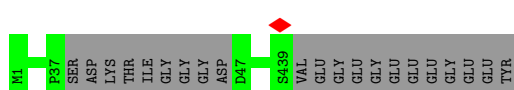

- Molecule 42: Tubulin alpha-1A chain

Chain MW:  95% 5%

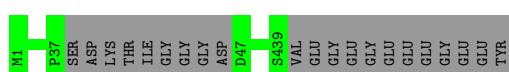

- Molecule 42: Tubulin alpha-1A chain

Chain MY:  95% 5%

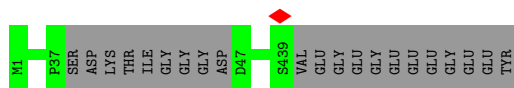

- Molecule 42: Tubulin alpha-1A chain

Chain NA:  96% 4%

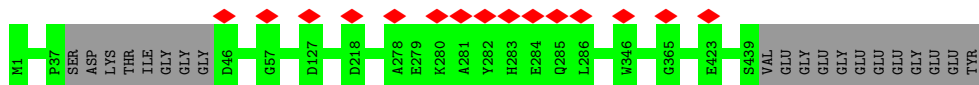

- Molecule 42: Tubulin alpha-1A chain

Chain NC:  97% 3%

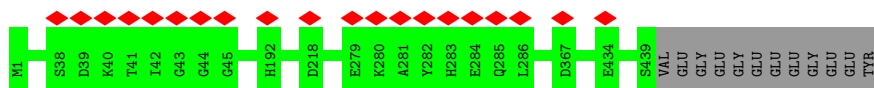

- Molecule 42: Tubulin alpha-1A chain

Chain NE:  5% 96% 1%

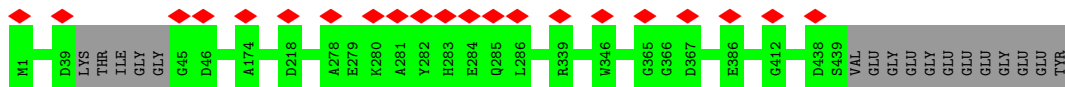

- Molecule 42: Tubulin alpha-1A chain

Chain NG:  5% 95% 5%

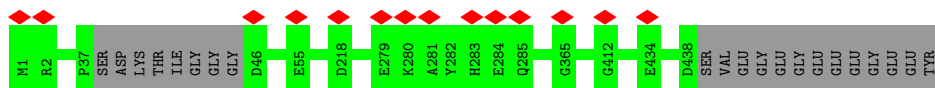

- Molecule 42: Tubulin alpha-1A chain

Chain NI:  5% 96% 5%

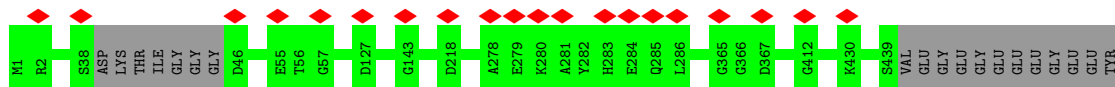

- Molecule 42: Tubulin alpha-1A chain

Chain NK:  6% 97% 1%

Chain OA:  96%

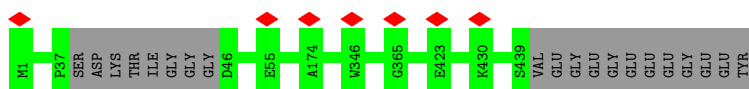

- Molecule 42: Tubulin alpha-1A chain

Chain OC:  96%

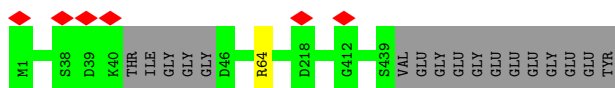

- Molecule 42: Tubulin alpha-1A chain

Chain OE:  96%

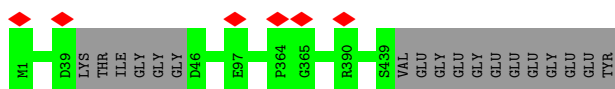

- Molecule 42: Tubulin alpha-1A chain

Chain OG:  96%

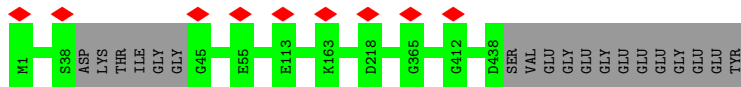

- Molecule 42: Tubulin alpha-1A chain

Chain OI:  96%

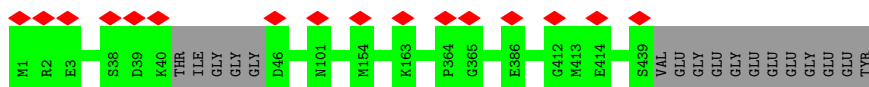

- Molecule 42: Tubulin alpha-1A chain

Chain OK:  97%

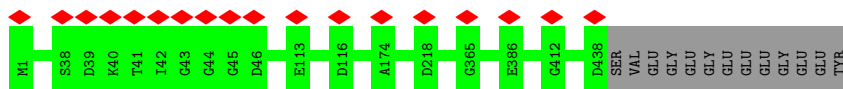

- Molecule 42: Tubulin alpha-1A chain

Chain OM:  97%

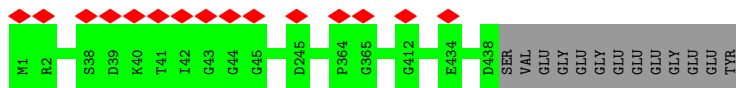

• Molecule 42: Tubulin alpha-1A chain

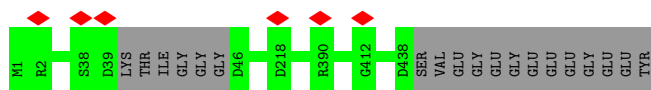

• Molecule 42: Tubulin alpha-1A chain

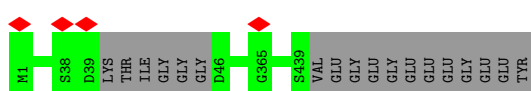

• Molecule 42: Tubulin alpha-1A chain

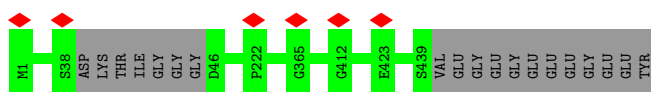

• Molecule 42: Tubulin alpha-1A chain

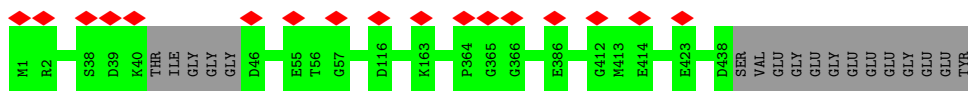

• Molecule 42: Tubulin alpha-1A chain

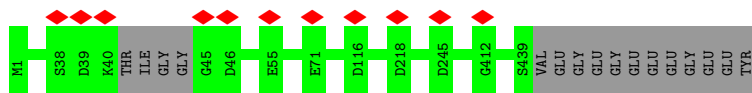

• Molecule 42: Tubulin alpha-1A chain

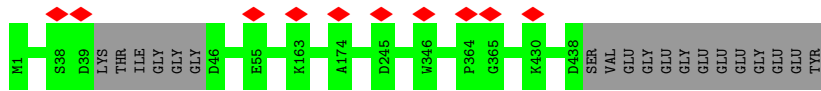

• Molecule 42: Tubulin alpha-1A chain



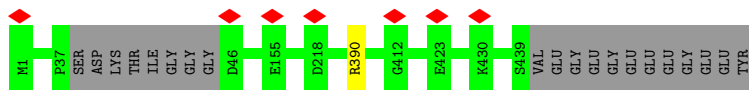

- Molecule 42: Tubulin alpha-1A chain

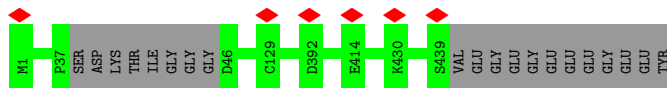

- Molecule 42: Tubulin alpha-1A chain

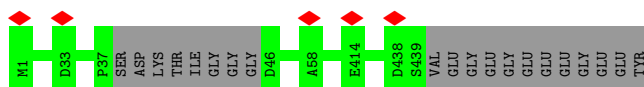

- Molecule 42: Tubulin alpha-1A chain

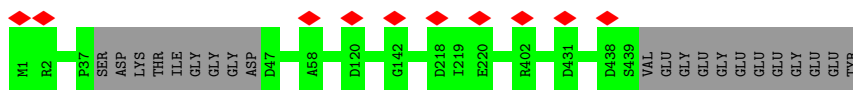

- Molecule 42: Tubulin alpha-1A chain

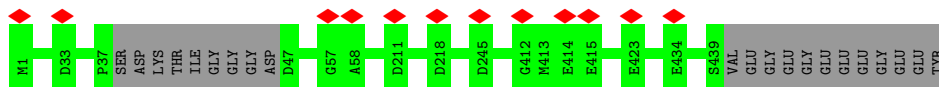

- Molecule 42: Tubulin alpha-1A chain

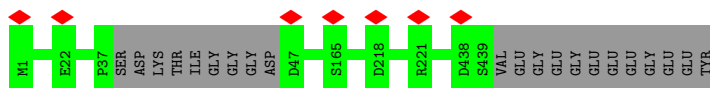

- Molecule 42: Tubulin alpha-1A chain

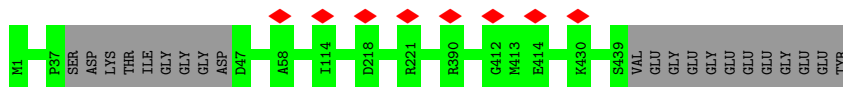

- Molecule 42: Tubulin alpha-1A chain

Chain PO:  95% 5%

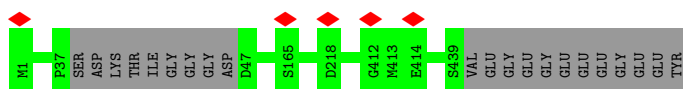

- Molecule 42: Tubulin alpha-1A chain

Chain PQ:  96% .

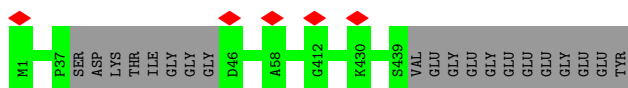

- Molecule 42: Tubulin alpha-1A chain

Chain PS:  96% .

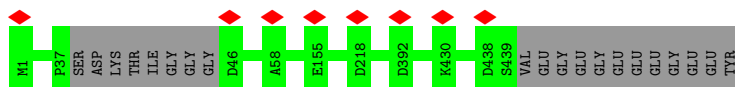

- Molecule 42: Tubulin alpha-1A chain

Chain PU:  95% 5%

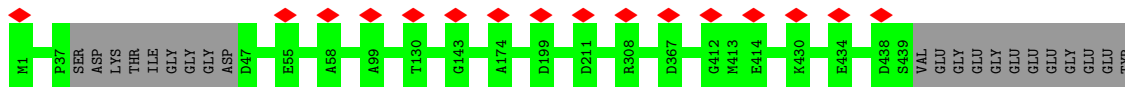

- Molecule 42: Tubulin alpha-1A chain

Chain PW:  95% 5%

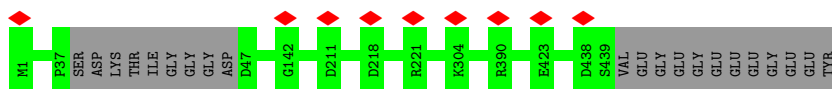

- Molecule 42: Tubulin alpha-1A chain

Chain PY:  95% 5%



- Molecule 42: Tubulin alpha-1A chain

Chain QA:  96% .

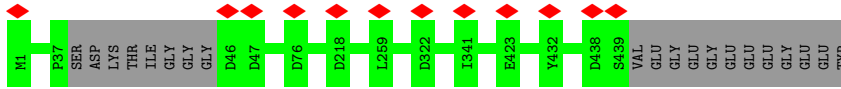

- Molecule 42: Tubulin alpha-1A chain

Chain QC: 96%

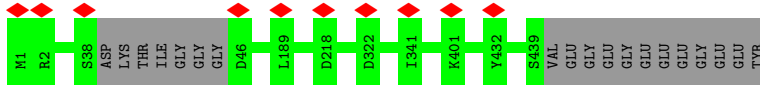

- Molecule 42: Tubulin alpha-1A chain

Chain QE: 97%

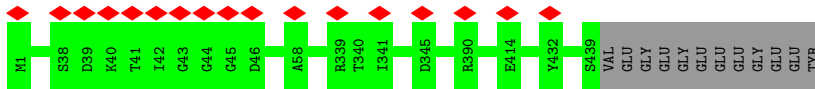

- Molecule 42: Tubulin alpha-1A chain

Chain QG: 95% 5%

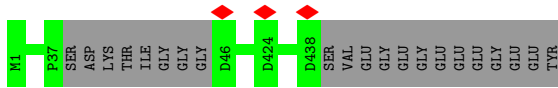

- Molecule 42: Tubulin alpha-1A chain

Chain QI: 96%



- Molecule 42: Tubulin alpha-1A chain

Chain QK: 97%

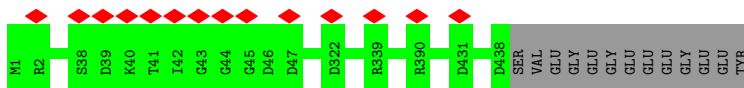

- Molecule 42: Tubulin alpha-1A chain

Chain QM: 96%

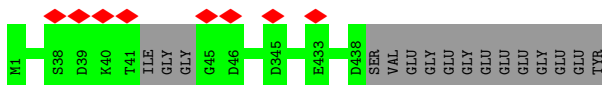

• Molecule 42: Tubulin alpha-1A chain

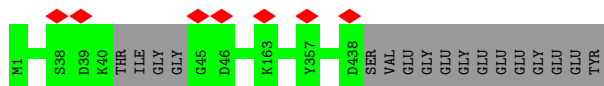

• Molecule 42: Tubulin alpha-1A chain

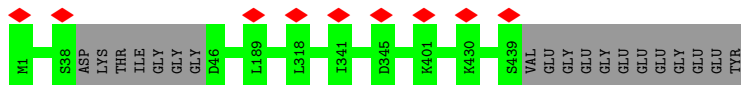

• Molecule 42: Tubulin alpha-1A chain

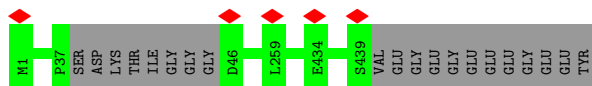

• Molecule 42: Tubulin alpha-1A chain

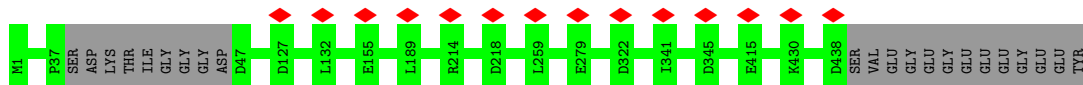

• Molecule 42: Tubulin alpha-1A chain

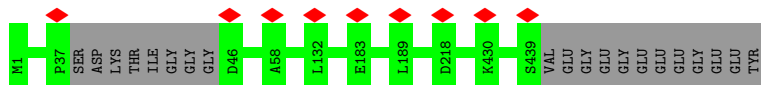

• Molecule 42: Tubulin alpha-1A chain

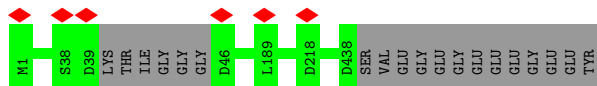

• Molecule 42: Tubulin alpha-1A chain



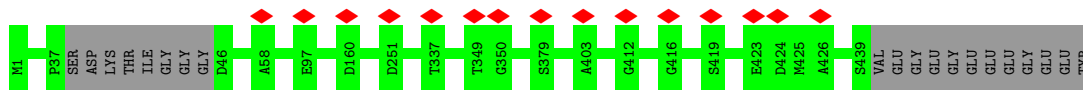

• Molecule 42: Tubulin alpha-1A chain

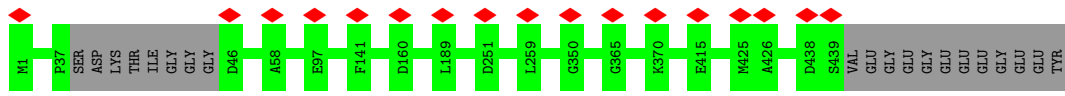

• Molecule 42: Tubulin alpha-1A chain

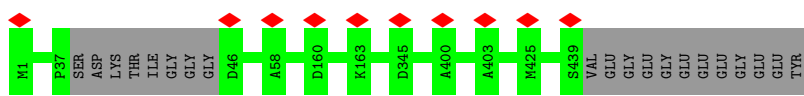

• Molecule 42: Tubulin alpha-1A chain

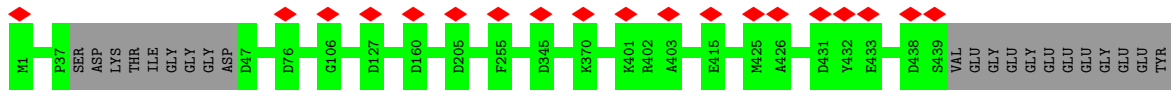

• Molecule 42: Tubulin alpha-1A chain

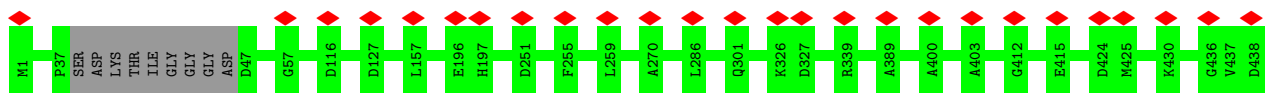

• Molecule 42: Tubulin alpha-1A chain

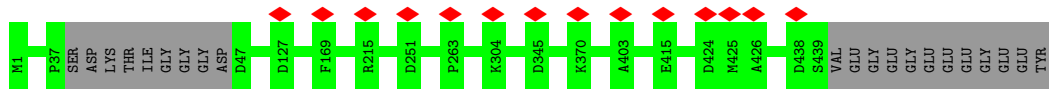

• Molecule 42: Tubulin alpha-1A chain



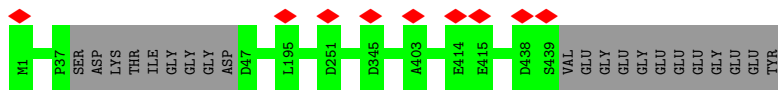

• Molecule 42: Tubulin alpha-1A chain

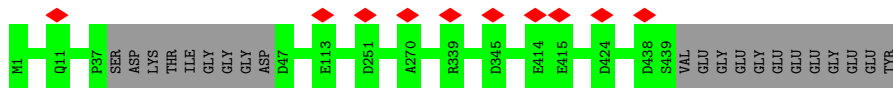

• Molecule 42: Tubulin alpha-1A chain

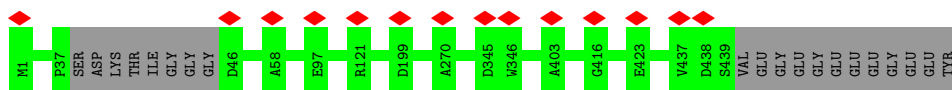

• Molecule 42: Tubulin alpha-1A chain

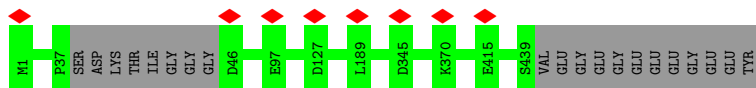

• Molecule 42: Tubulin alpha-1A chain

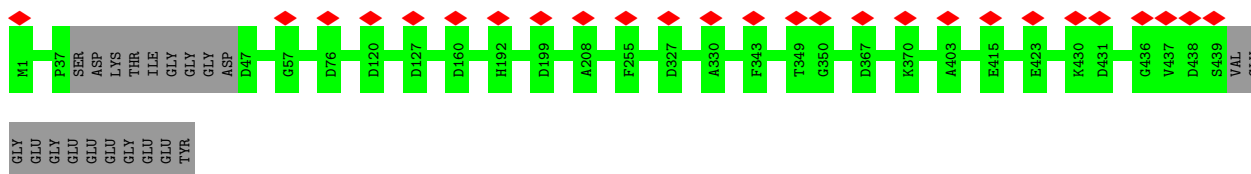

• Molecule 42: Tubulin alpha-1A chain

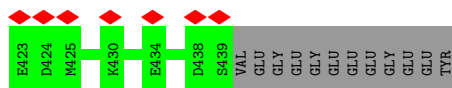
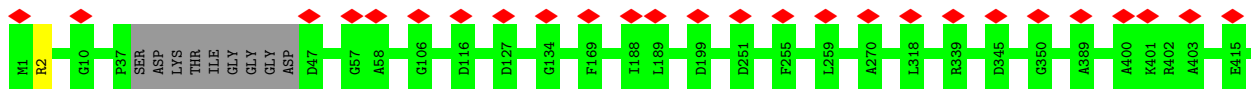

• Molecule 42: Tubulin alpha-1A chain

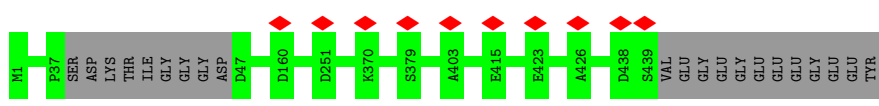

• Molecule 42: Tubulin alpha-1A chain

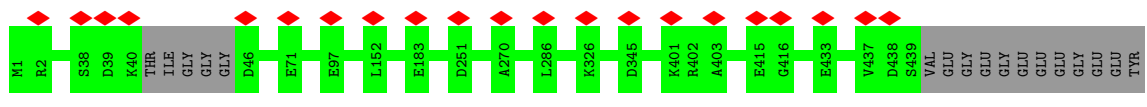

• Molecule 42: Tubulin alpha-1A chain

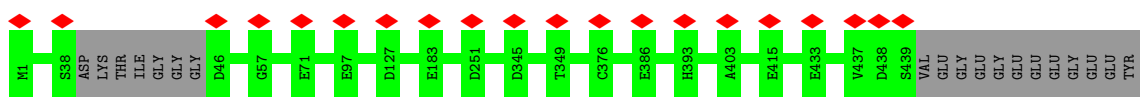

• Molecule 42: Tubulin alpha-1A chain

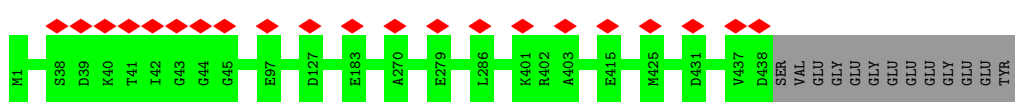

• Molecule 42: Tubulin alpha-1A chain

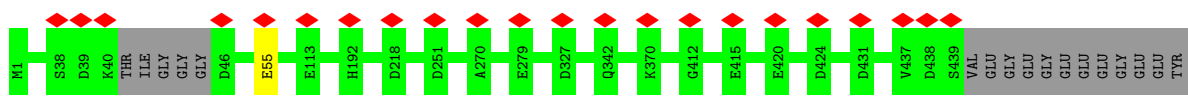
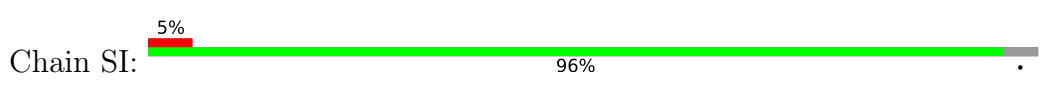

• Molecule 42: Tubulin alpha-1A chain

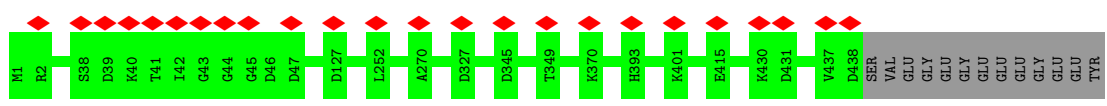

• Molecule 42: Tubulin alpha-1A chain

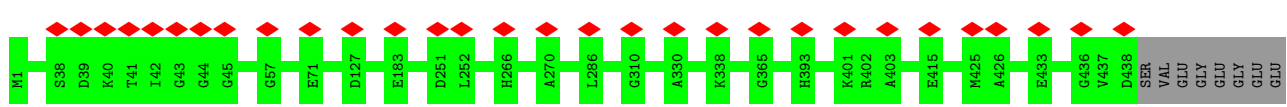

GLU
GLU
GLU
TYR

- Molecule 42: Tubulin alpha-1A chain

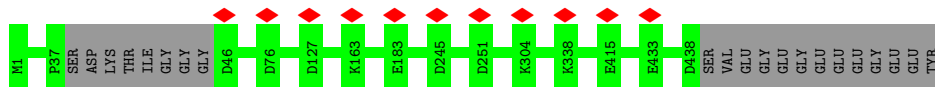

- Molecule 42: Tubulin alpha-1A chain

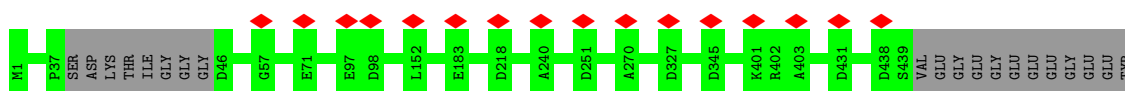

- Molecule 42: Tubulin alpha-1A chain

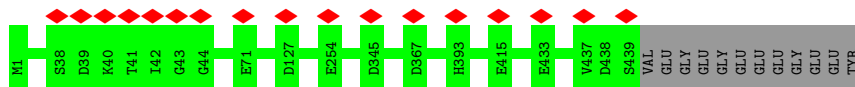

- Molecule 42: Tubulin alpha-1A chain

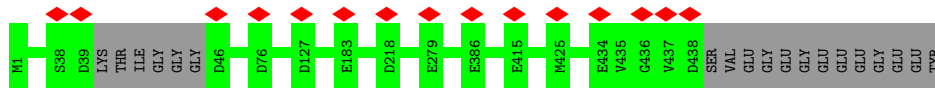

- Molecule 42: Tubulin alpha-1A chain

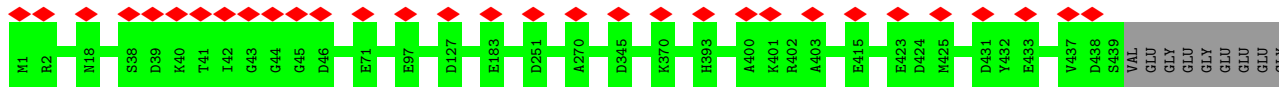

GLU
GLU
TYR

- Molecule 42: Tubulin alpha-1A chain

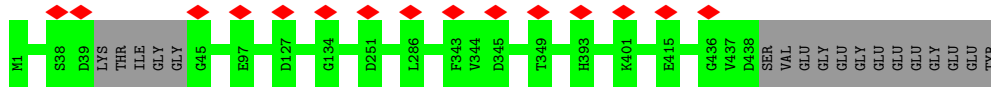

• Molecule 42: Tubulin alpha-1A chain

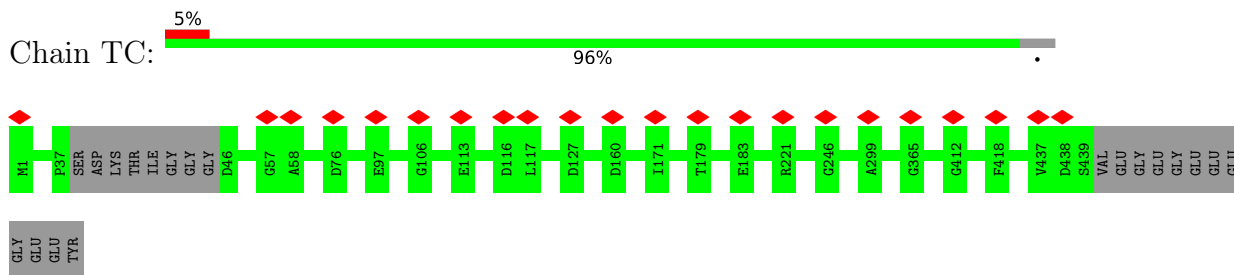

• Molecule 42: Tubulin alpha-1A chain

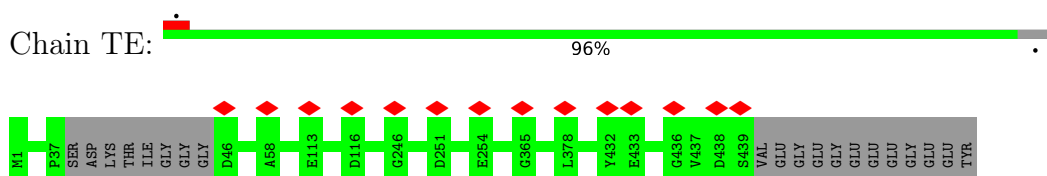

• Molecule 42: Tubulin alpha-1A chain

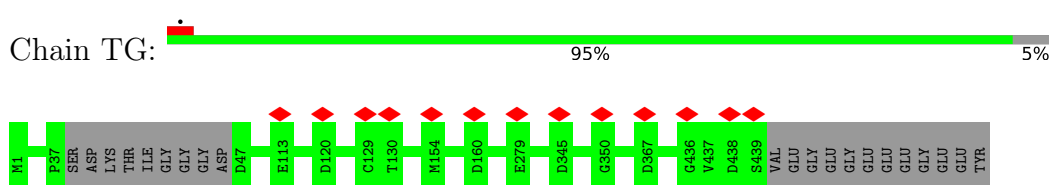

• Molecule 42: Tubulin alpha-1A chain

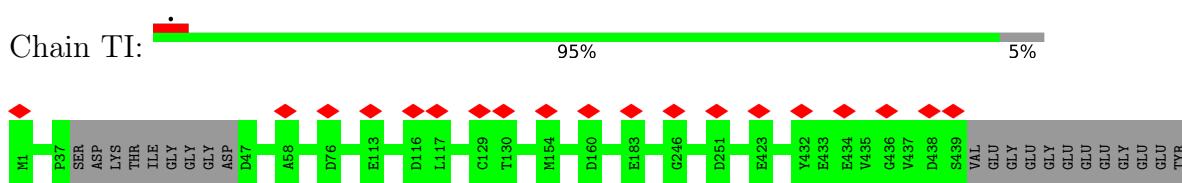

• Molecule 42: Tubulin alpha-1A chain

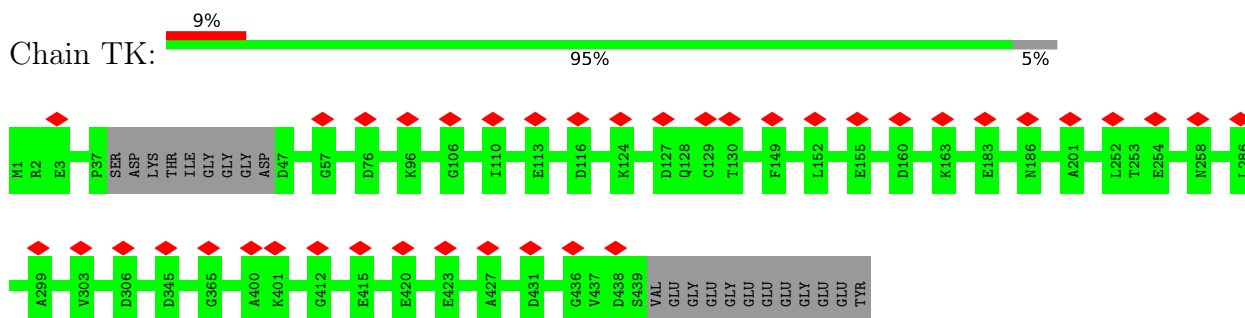

• Molecule 42: Tubulin alpha-1A chain



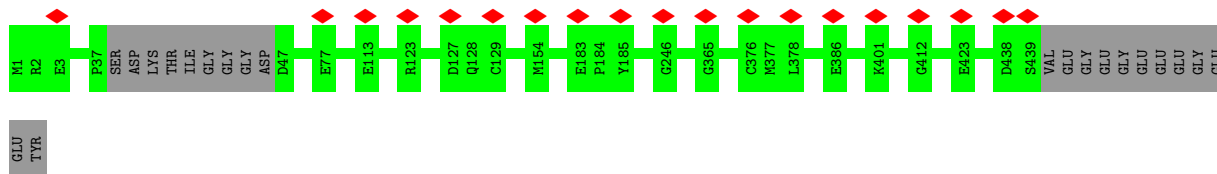

• Molecule 42: Tubulin alpha-1A chain

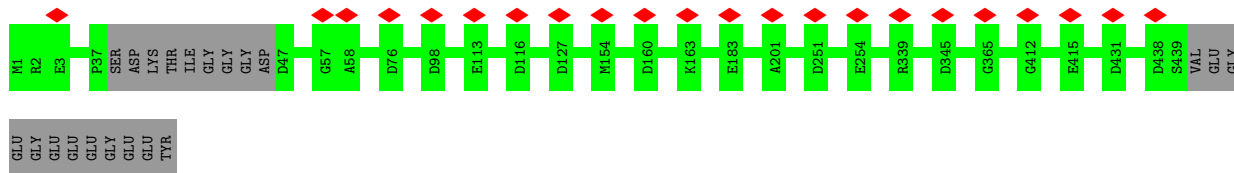

• Molecule 42: Tubulin alpha-1A chain

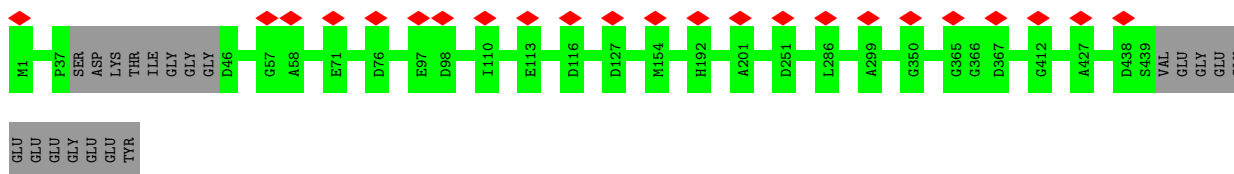

• Molecule 42: Tubulin alpha-1A chain



• Molecule 42: Tubulin alpha-1A chain

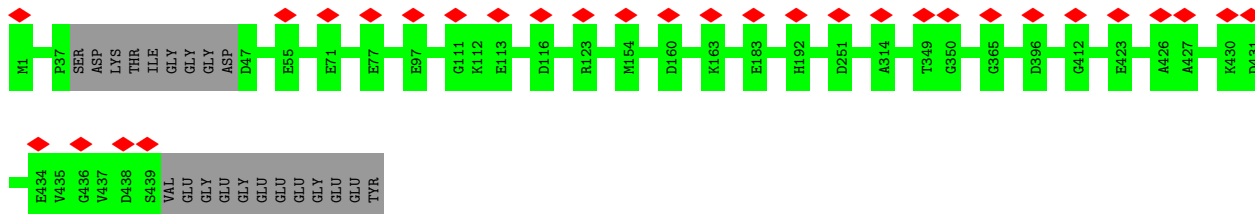

• Molecule 42: Tubulin alpha-1A chain



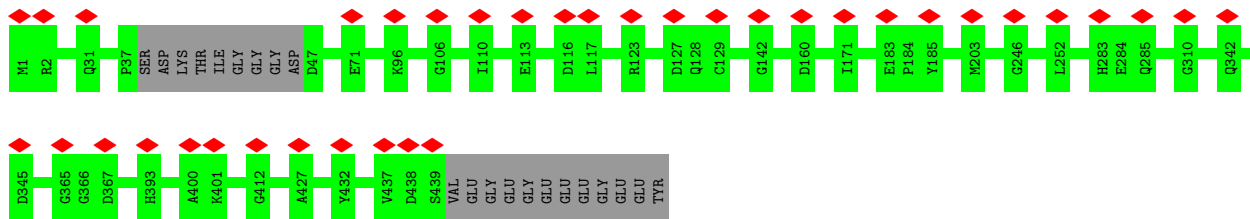

• Molecule 42: Tubulin alpha-1A chain

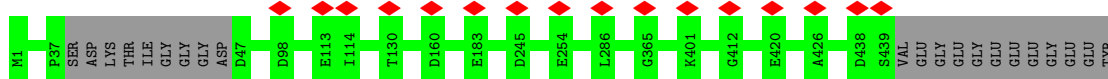

• Molecule 42: Tubulin alpha-1A chain

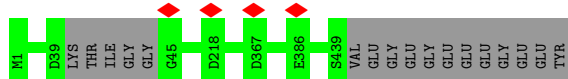

• Molecule 42: Tubulin alpha-1A chain

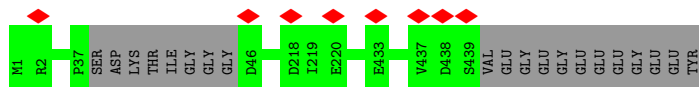

• Molecule 42: Tubulin alpha-1A chain

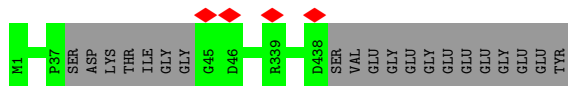

• Molecule 42: Tubulin alpha-1A chain

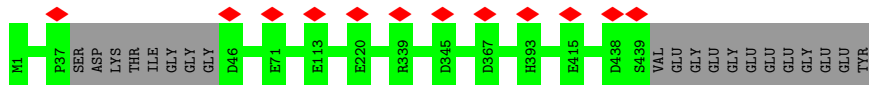

• Molecule 42: Tubulin alpha-1A chain



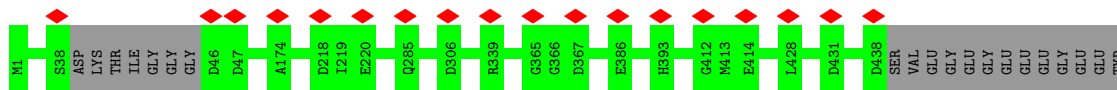

• Molecule 42: Tubulin alpha-1A chain

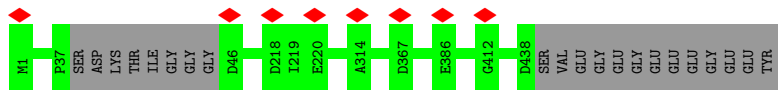

• Molecule 42: Tubulin alpha-1A chain

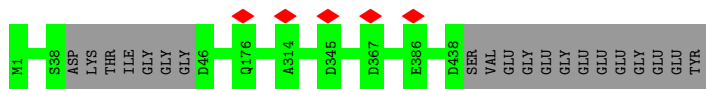

• Molecule 42: Tubulin alpha-1A chain

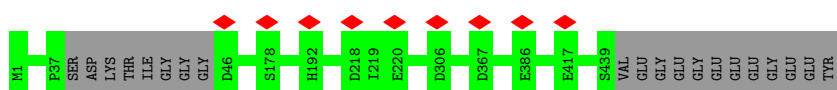

• Molecule 42: Tubulin alpha-1A chain

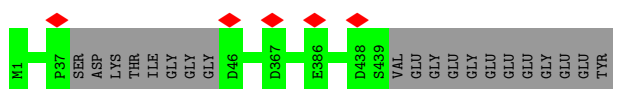

• Molecule 42: Tubulin alpha-1A chain

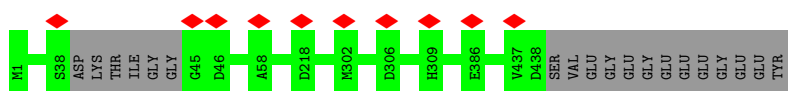

• Molecule 42: Tubulin alpha-1A chain

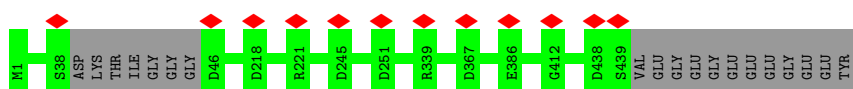

• Molecule 42: Tubulin alpha-1A chain

Chain UY:  96%

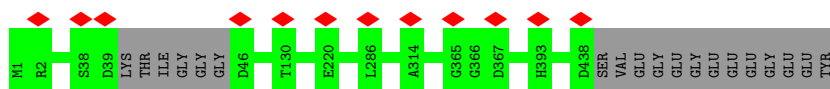

- Molecule 42: Tubulin alpha-1A chain

Chain VC:  96%



- Molecule 42: Tubulin alpha-1A chain

Chain VE:  96%

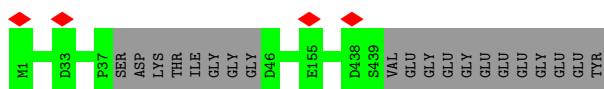

- Molecule 42: Tubulin alpha-1A chain

Chain VG:  95% 5%

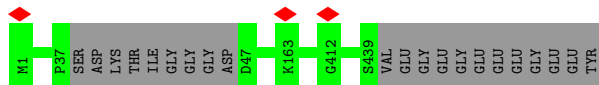

- Molecule 42: Tubulin alpha-1A chain

Chain VI:  95% 5%

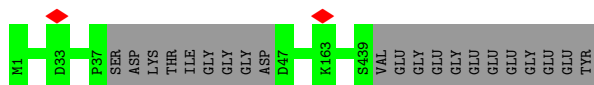

- Molecule 42: Tubulin alpha-1A chain

Chain VK:  95% 5%

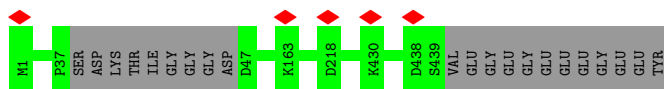

- Molecule 42: Tubulin alpha-1A chain

Chain VM:  95% 5%

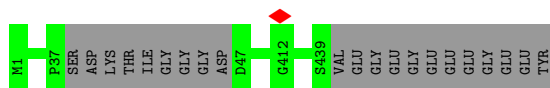

• Molecule 42: Tubulin alpha-1A chain

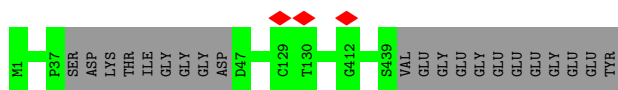

• Molecule 42: Tubulin alpha-1A chain

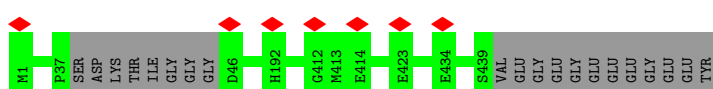

• Molecule 42: Tubulin alpha-1A chain

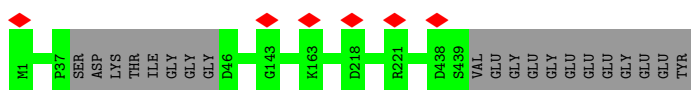

• Molecule 42: Tubulin alpha-1A chain

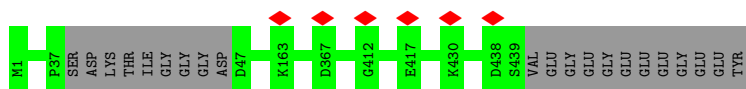

• Molecule 42: Tubulin alpha-1A chain

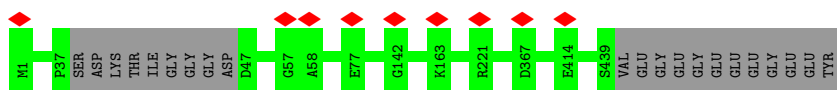

• Molecule 42: Tubulin alpha-1A chain

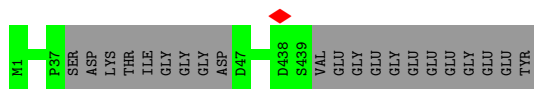

• Molecule 42: Tubulin alpha-1A chain



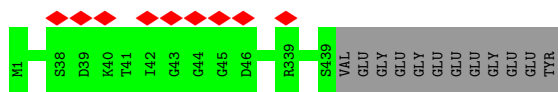

- Molecule 42: Tubulin alpha-1A chain

Chain WC: 96%

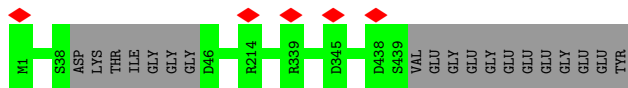

- Molecule 42: Tubulin alpha-1A chain

Chain WE: 97%

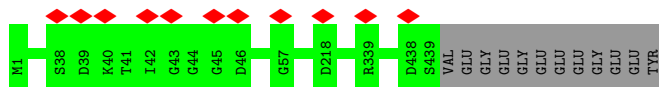

- Molecule 42: Tubulin alpha-1A chain

Chain WG: 96%



- Molecule 42: Tubulin alpha-1A chain

Chain WI: 97%

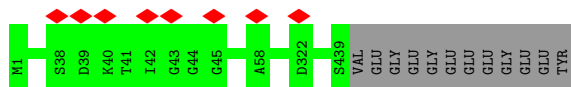

- Molecule 42: Tubulin alpha-1A chain

Chain WK: 97%

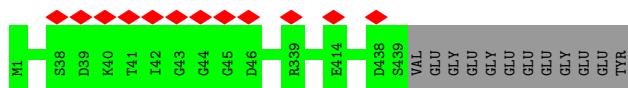

- Molecule 42: Tubulin alpha-1A chain

Chain WM: 97%

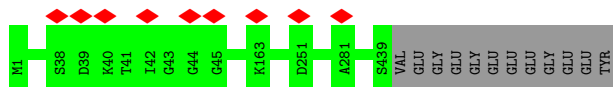

- Molecule 42: Tubulin alpha-1A chain

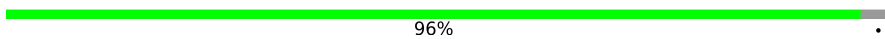
Chain WO:  96%

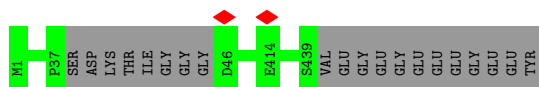

• Molecule 42: Tubulin alpha-1A chain

Chain WQ:  97%

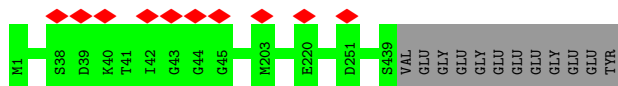

• Molecule 42: Tubulin alpha-1A chain

Chain WS:  96%

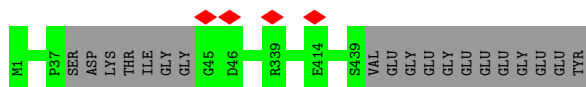

• Molecule 42: Tubulin alpha-1A chain

Chain WU:  97%

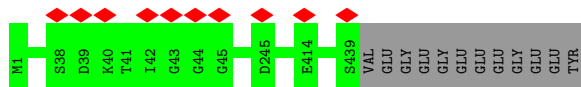

• Molecule 42: Tubulin alpha-1A chain

Chain WW:  97%

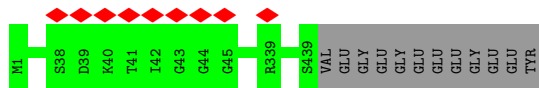

• Molecule 43: Tubulin beta-4B chain

Chain AB:  98%

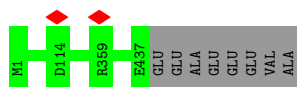

• Molecule 43: Tubulin beta-4B chain

Chain AD:  98%

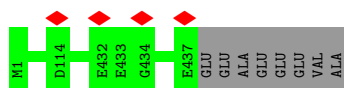

- Molecule 43: Tubulin beta-4B chain

Chain AF:  98%

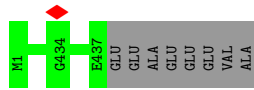

- Molecule 43: Tubulin beta-4B chain

Chain AH:  97%

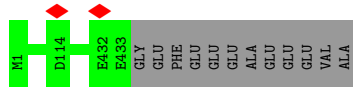

- Molecule 43: Tubulin beta-4B chain

Chain AJ:  98%

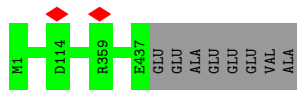

- Molecule 43: Tubulin beta-4B chain

Chain AL:  98%

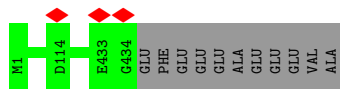

- Molecule 43: Tubulin beta-4B chain

Chain AN:  98%

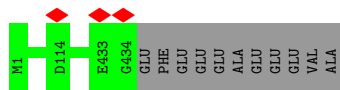

- Molecule 43: Tubulin beta-4B chain

Chain AP:  98%

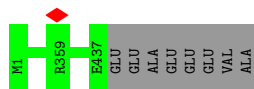

- Molecule 43: Tubulin beta-4B chain

Chain AR:  98%

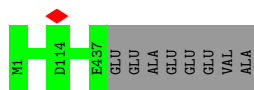

• Molecule 43: Tubulin beta-4B chain

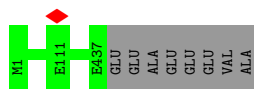

• Molecule 43: Tubulin beta-4B chain



• Molecule 43: Tubulin beta-4B chain

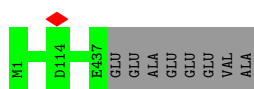

• Molecule 43: Tubulin beta-4B chain

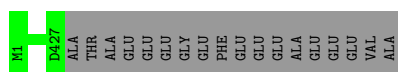

• Molecule 43: Tubulin beta-4B chain

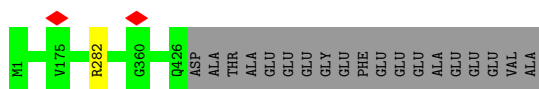

• Molecule 43: Tubulin beta-4B chain

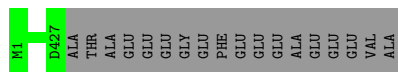

• Molecule 43: Tubulin beta-4B chain



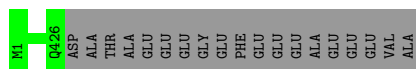

- Molecule 43: Tubulin beta-4B chain

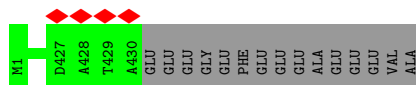

- Molecule 43: Tubulin beta-4B chain

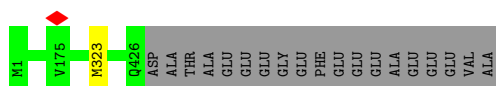

- Molecule 43: Tubulin beta-4B chain

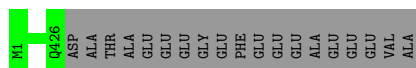

- Molecule 43: Tubulin beta-4B chain

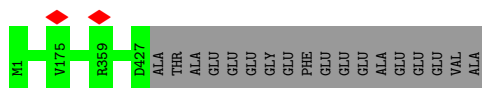

- Molecule 43: Tubulin beta-4B chain

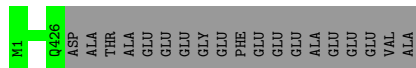

- Molecule 43: Tubulin beta-4B chain

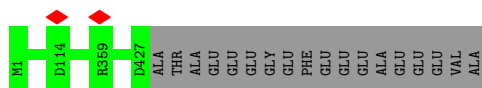

- Molecule 43: Tubulin beta-4B chain



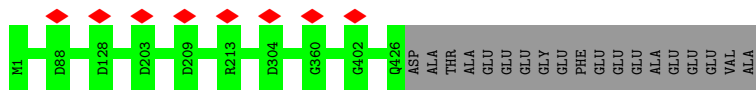

- Molecule 43: Tubulin beta-4B chain

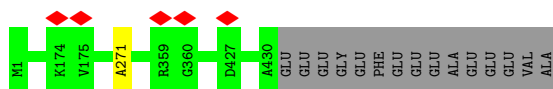

- Molecule 43: Tubulin beta-4B chain

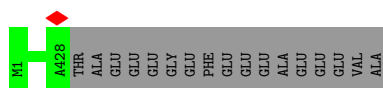

- Molecule 43: Tubulin beta-4B chain

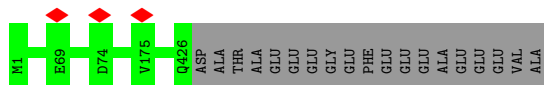

- Molecule 43: Tubulin beta-4B chain

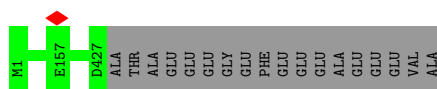

- Molecule 43: Tubulin beta-4B chain

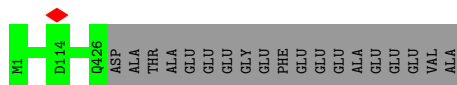

- Molecule 43: Tubulin beta-4B chain

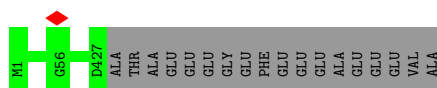

- Molecule 43: Tubulin beta-4B chain

Chain CL:  96%



- Molecule 43: Tubulin beta-4B chain

Chain CN:  96%

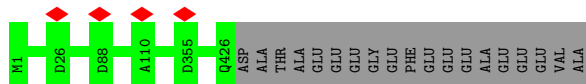

- Molecule 43: Tubulin beta-4B chain

Chain CP:  96%

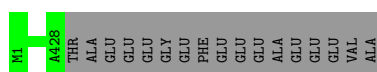

- Molecule 43: Tubulin beta-4B chain

Chain CR:  96%

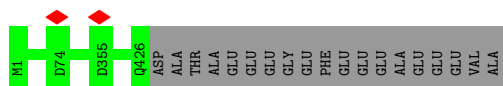

- Molecule 43: Tubulin beta-4B chain

Chain CT:  96%

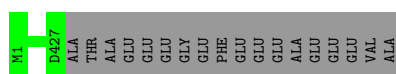

- Molecule 43: Tubulin beta-4B chain

Chain CV:  96%

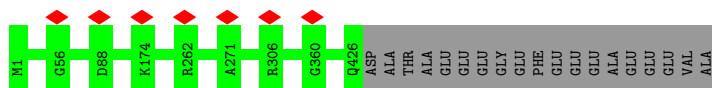

- Molecule 43: Tubulin beta-4B chain

Chain CX:  96%

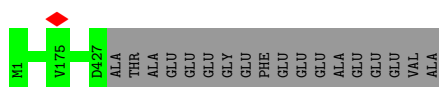

- Molecule 43: Tubulin beta-4B chain

Chain CZ:  96%

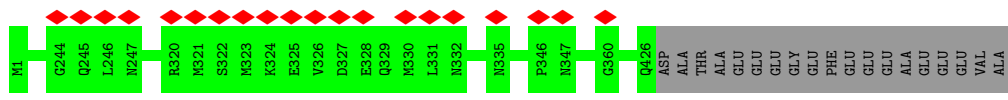

• Molecule 43: Tubulin beta-4B chain

Chain DB:  96%

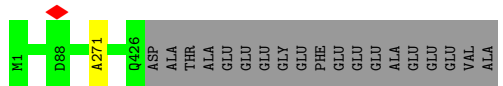

• Molecule 43: Tubulin beta-4B chain

Chain DD:  96%

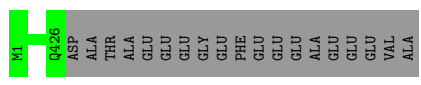

• Molecule 43: Tubulin beta-4B chain

Chain DF:  96%

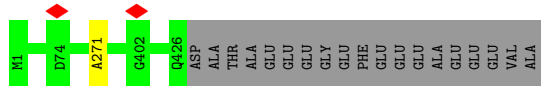

• Molecule 43: Tubulin beta-4B chain

Chain DH:  96%



• Molecule 43: Tubulin beta-4B chain

Chain DJ:  96%

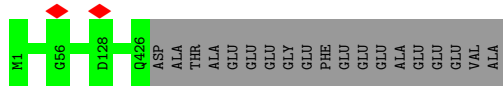

• Molecule 43: Tubulin beta-4B chain

Chain DL:  96%

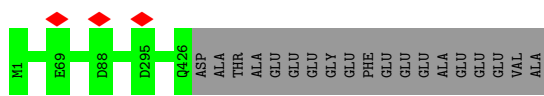

• Molecule 43: Tubulin beta-4B chain

Chain DN:  96%

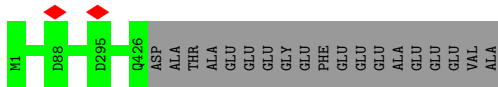

- Molecule 43: Tubulin beta-4B chain

Chain DP:  96%



- Molecule 43: Tubulin beta-4B chain

Chain DR:  96%

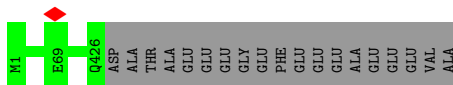

- Molecule 43: Tubulin beta-4B chain

Chain DT:  96%

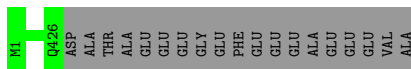

- Molecule 43: Tubulin beta-4B chain

Chain DV:  96%



- Molecule 43: Tubulin beta-4B chain

Chain DX:  96%

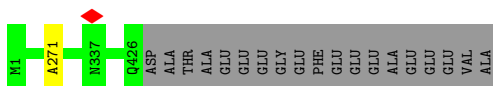

- Molecule 43: Tubulin beta-4B chain

Chain DZ:  96%

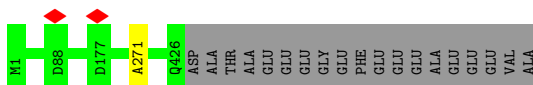

- Molecule 43: Tubulin beta-4B chain

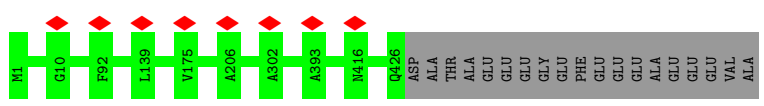

• Molecule 43: Tubulin beta-4B chain

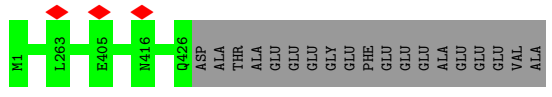

• Molecule 43: Tubulin beta-4B chain

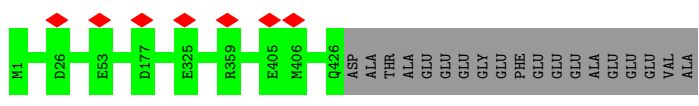

• Molecule 43: Tubulin beta-4B chain

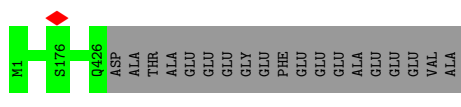

• Molecule 43: Tubulin beta-4B chain

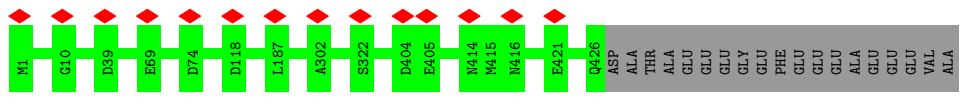

• Molecule 43: Tubulin beta-4B chain

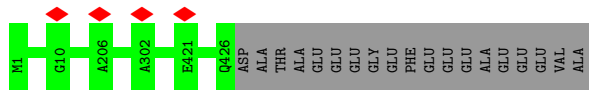

• Molecule 43: Tubulin beta-4B chain

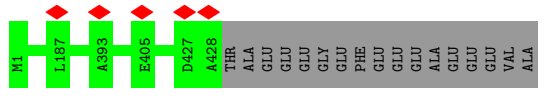

• Molecule 43: Tubulin beta-4B chain

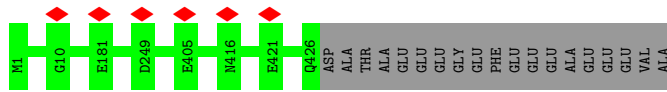

• Molecule 43: Tubulin beta-4B chain

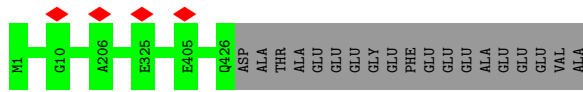

• Molecule 43: Tubulin beta-4B chain

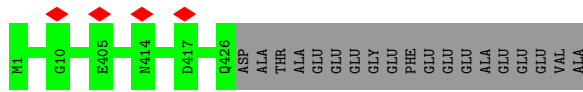

• Molecule 43: Tubulin beta-4B chain

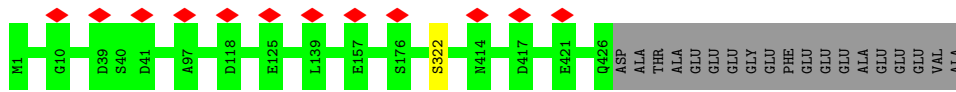

• Molecule 43: Tubulin beta-4B chain

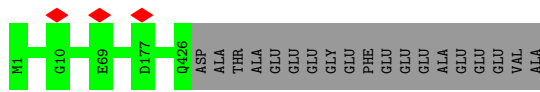

• Molecule 43: Tubulin beta-4B chain

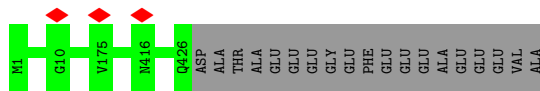

• Molecule 43: Tubulin beta-4B chain



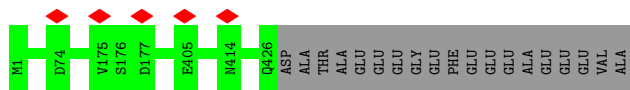

• Molecule 43: Tubulin beta-4B chain

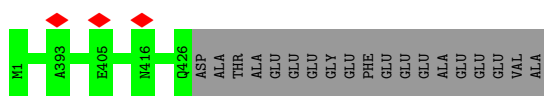

• Molecule 43: Tubulin beta-4B chain

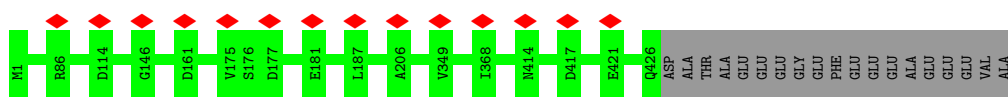

• Molecule 43: Tubulin beta-4B chain

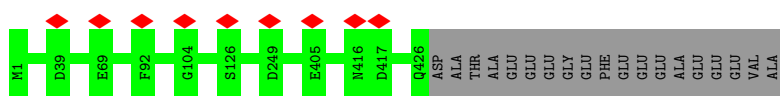

• Molecule 43: Tubulin beta-4B chain

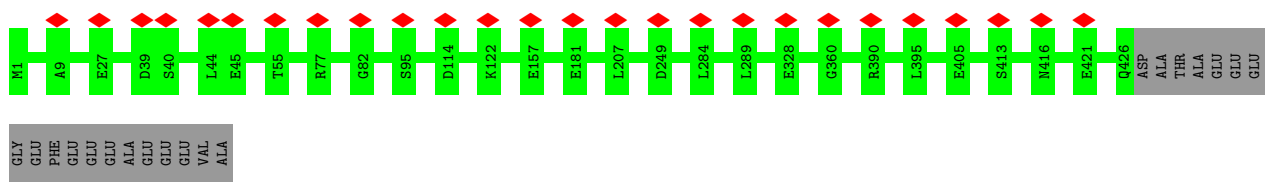

• Molecule 43: Tubulin beta-4B chain

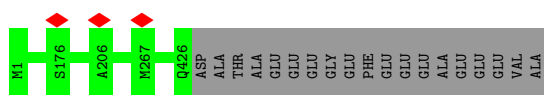

• Molecule 43: Tubulin beta-4B chain

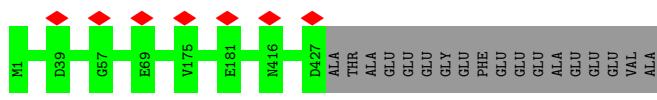

• Molecule 43: Tubulin beta-4B chain

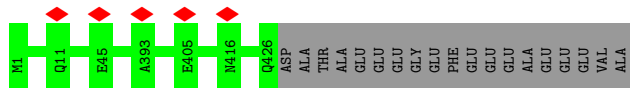

• Molecule 43: Tubulin beta-4B chain

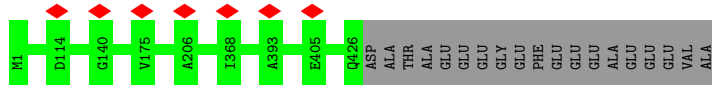

• Molecule 43: Tubulin beta-4B chain

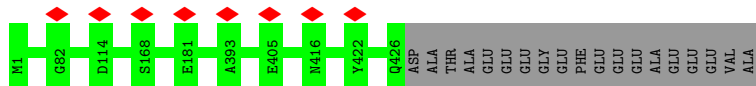

• Molecule 43: Tubulin beta-4B chain

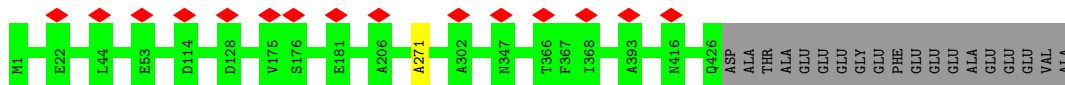

• Molecule 43: Tubulin beta-4B chain

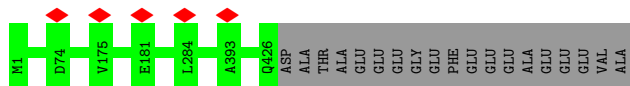

• Molecule 43: Tubulin beta-4B chain

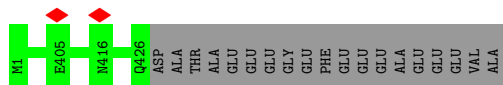

• Molecule 43: Tubulin beta-4B chain



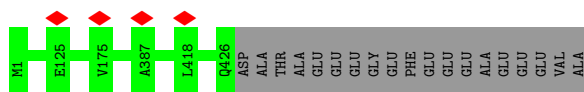

- Molecule 43: Tubulin beta-4B chain

Chain GD: 96%

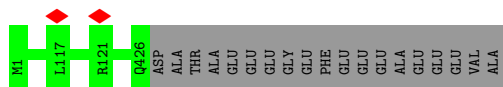

- Molecule 43: Tubulin beta-4B chain

Chain GF: 96%

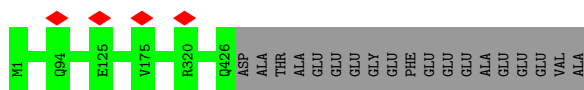

- Molecule 43: Tubulin beta-4B chain

Chain GH: 96%

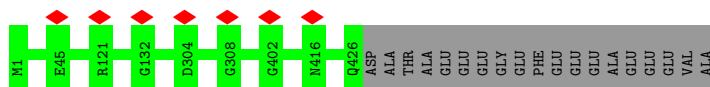

- Molecule 43: Tubulin beta-4B chain

Chain GJ: 96%

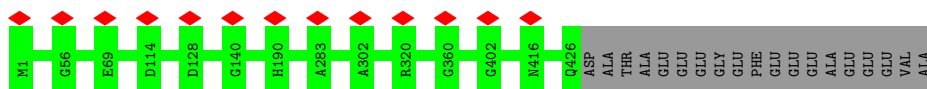

- Molecule 43: Tubulin beta-4B chain

Chain GL: 96%

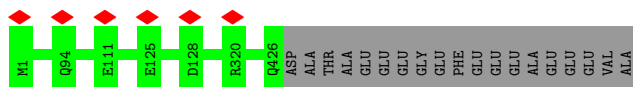

- Molecule 43: Tubulin beta-4B chain

Chain GN: 96%

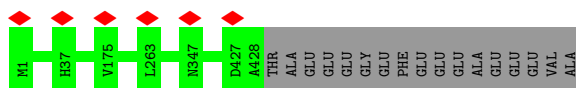

- Molecule 43: Tubulin beta-4B chain

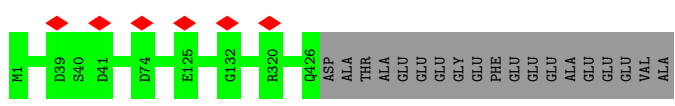

• Molecule 43: Tubulin beta-4B chain

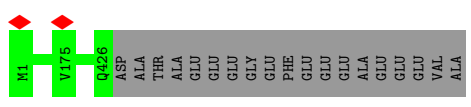

• Molecule 43: Tubulin beta-4B chain

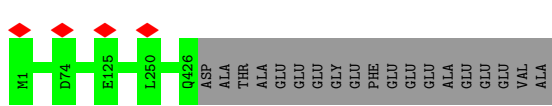

• Molecule 43: Tubulin beta-4B chain

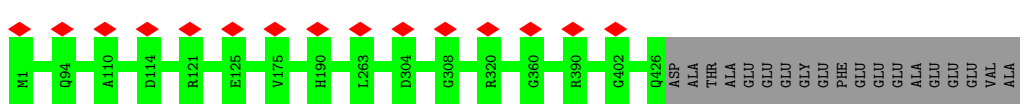

• Molecule 43: Tubulin beta-4B chain

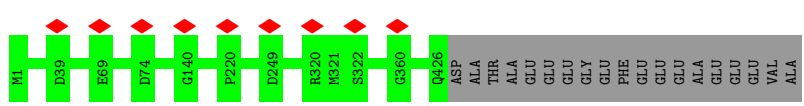

• Molecule 43: Tubulin beta-4B chain

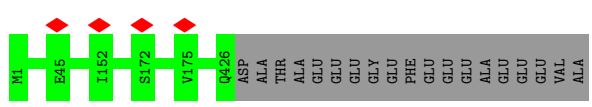

• Molecule 43: Tubulin beta-4B chain

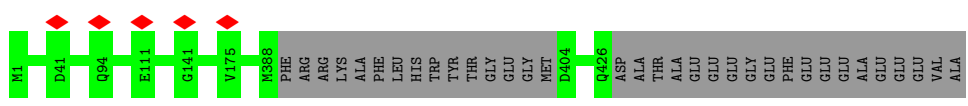
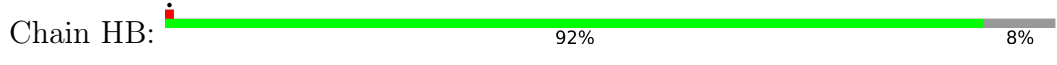

• Molecule 43: Tubulin beta-4B chain

Chain HD:  96%

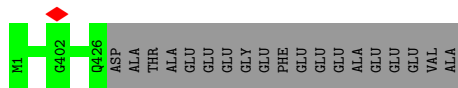

• Molecule 43: Tubulin beta-4B chain

Chain HF:  96%

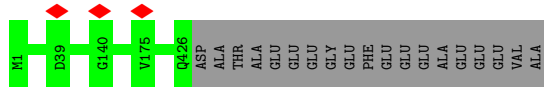

• Molecule 43: Tubulin beta-4B chain

Chain HH:  96%

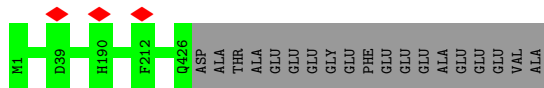

• Molecule 43: Tubulin beta-4B chain

Chain HJ:  96%

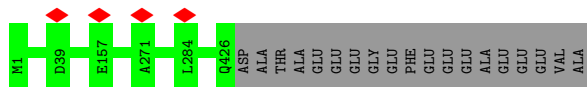

• Molecule 43: Tubulin beta-4B chain

Chain HL:  96%

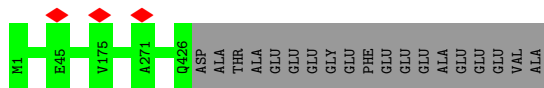

• Molecule 43: Tubulin beta-4B chain

Chain HN:  96%

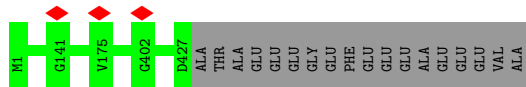

• Molecule 43: Tubulin beta-4B chain

Chain HP:  96%

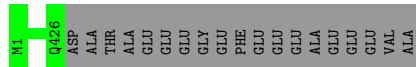

- Molecule 43: Tubulin beta-4B chain

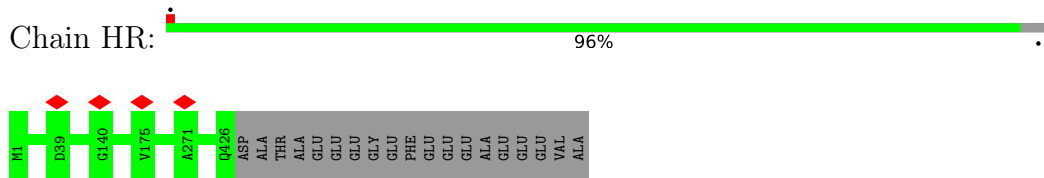

- Molecule 43: Tubulin beta-4B chain

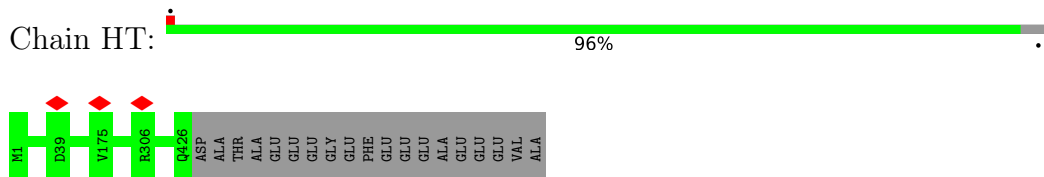

- Molecule 43: Tubulin beta-4B chain

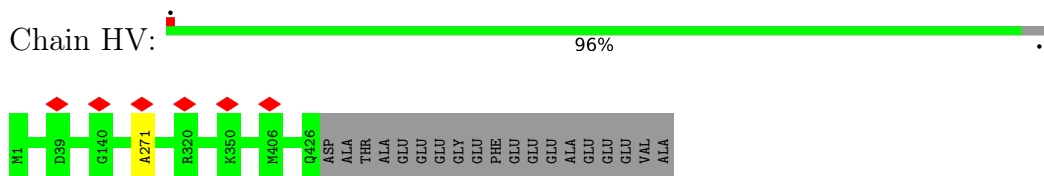

- Molecule 43: Tubulin beta-4B chain

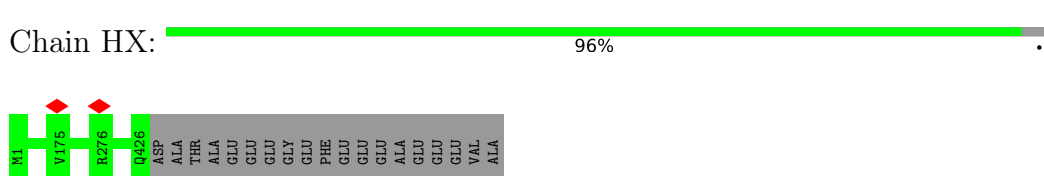

- Molecule 43: Tubulin beta-4B chain

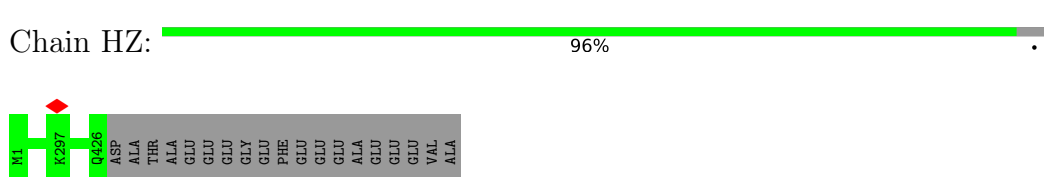

- Molecule 43: Tubulin beta-4B chain

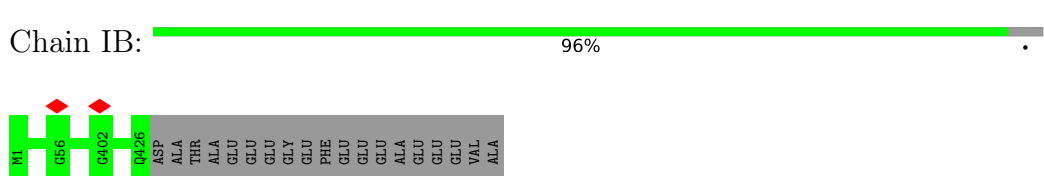

- Molecule 43: Tubulin beta-4B chain



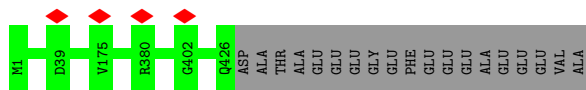

• Molecule 43: Tubulin beta-4B chain

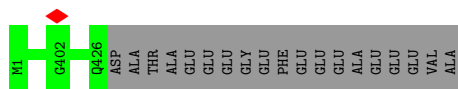

• Molecule 43: Tubulin beta-4B chain

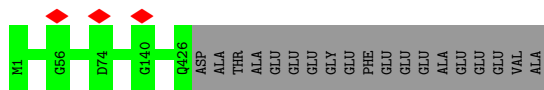

• Molecule 43: Tubulin beta-4B chain

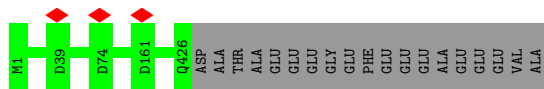

• Molecule 43: Tubulin beta-4B chain

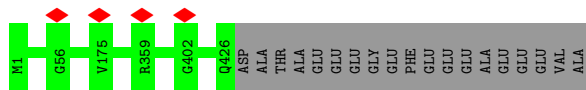

• Molecule 43: Tubulin beta-4B chain

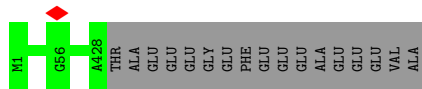

• Molecule 43: Tubulin beta-4B chain

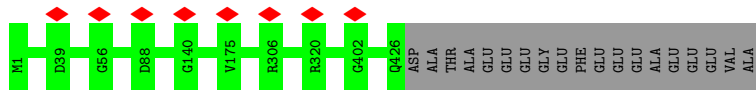
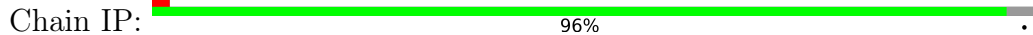

• Molecule 43: Tubulin beta-4B chain

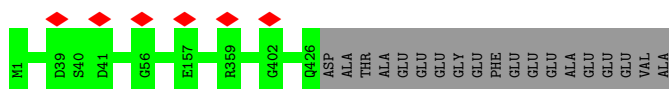

• Molecule 43: Tubulin beta-4B chain

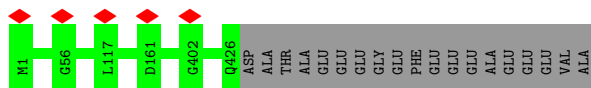

• Molecule 43: Tubulin beta-4B chain

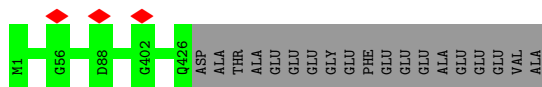

• Molecule 43: Tubulin beta-4B chain

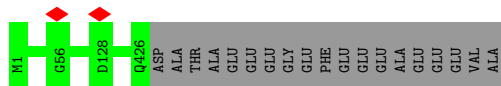

• Molecule 43: Tubulin beta-4B chain

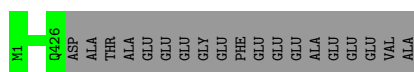

• Molecule 43: Tubulin beta-4B chain

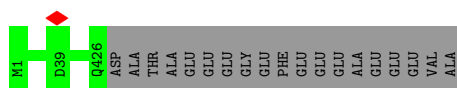

• Molecule 43: Tubulin beta-4B chain

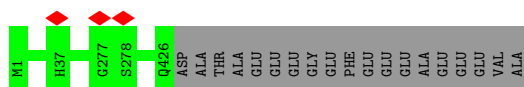

• Molecule 43: Tubulin beta-4B chain

Chain JH:  96%

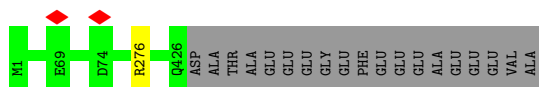

• Molecule 43: Tubulin beta-4B chain

Chain JJ:  96%

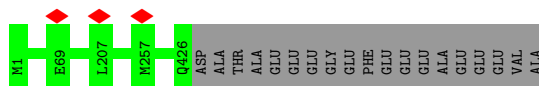

• Molecule 43: Tubulin beta-4B chain

Chain JL:  96%

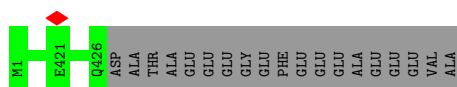

• Molecule 43: Tubulin beta-4B chain

Chain JN:  96%

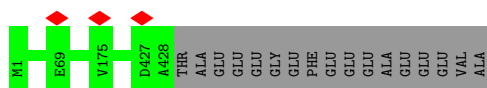

• Molecule 43: Tubulin beta-4B chain

Chain JP:  96%

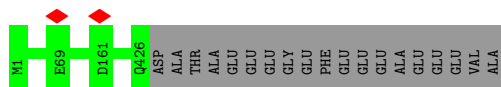

• Molecule 43: Tubulin beta-4B chain

Chain JR:  96%

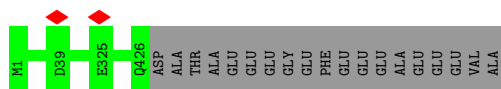

• Molecule 43: Tubulin beta-4B chain

Chain JT:  96%



• Molecule 43: Tubulin beta-4B chain

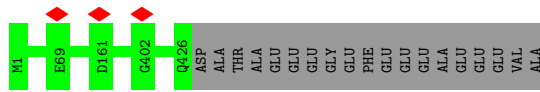

• Molecule 43: Tubulin beta-4B chain

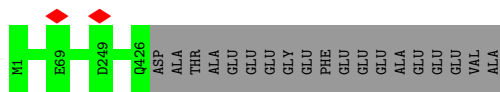

• Molecule 43: Tubulin beta-4B chain

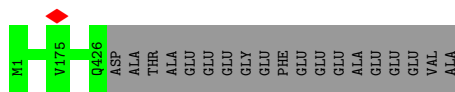

• Molecule 43: Tubulin beta-4B chain

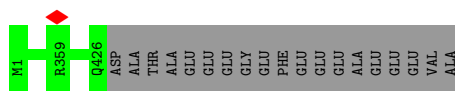

• Molecule 43: Tubulin beta-4B chain

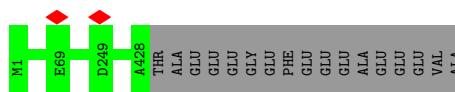

• Molecule 43: Tubulin beta-4B chain

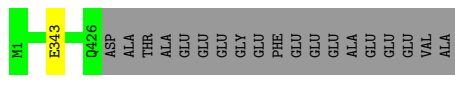

• Molecule 43: Tubulin beta-4B chain

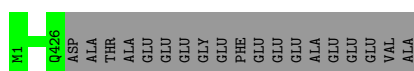

- Molecule 43: Tubulin beta-4B chain

Chain KJ:  96%

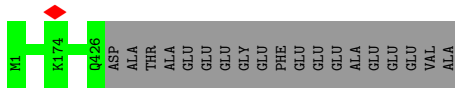

- Molecule 43: Tubulin beta-4B chain

Chain KL:  96%

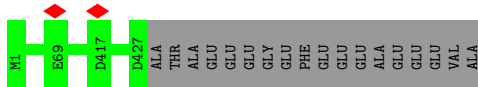

- Molecule 43: Tubulin beta-4B chain

Chain KN:  96%

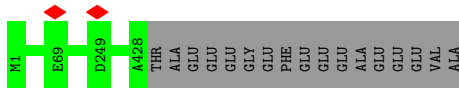

- Molecule 43: Tubulin beta-4B chain

Chain KP:  96%

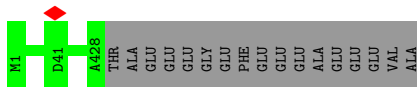

- Molecule 43: Tubulin beta-4B chain

Chain KR:  96%

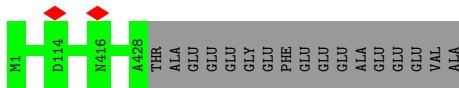

- Molecule 43: Tubulin beta-4B chain

Chain KT:  96%

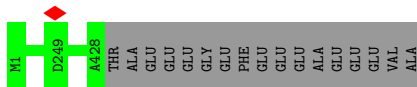

- Molecule 43: Tubulin beta-4B chain

Chain KV:  96%

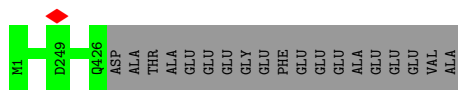

• Molecule 43: Tubulin beta-4B chain

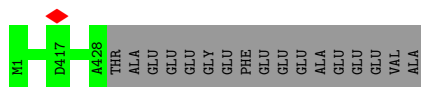

• Molecule 43: Tubulin beta-4B chain

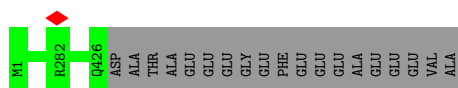

• Molecule 43: Tubulin beta-4B chain

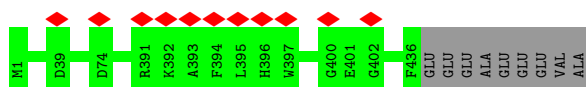

• Molecule 43: Tubulin beta-4B chain

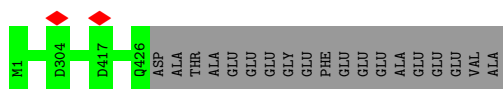

• Molecule 43: Tubulin beta-4B chain

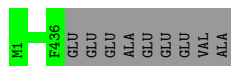

• Molecule 43: Tubulin beta-4B chain

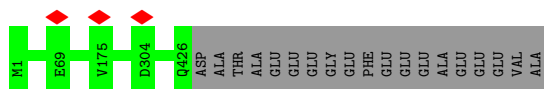

• Molecule 43: Tubulin beta-4B chain



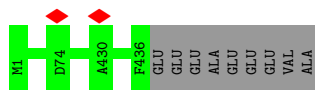

• Molecule 43: Tubulin beta-4B chain

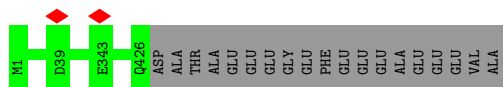

• Molecule 43: Tubulin beta-4B chain

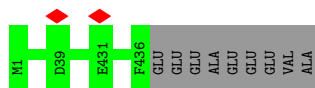

• Molecule 43: Tubulin beta-4B chain

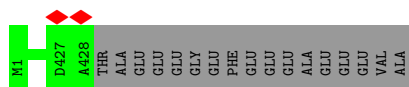

• Molecule 43: Tubulin beta-4B chain



• Molecule 43: Tubulin beta-4B chain

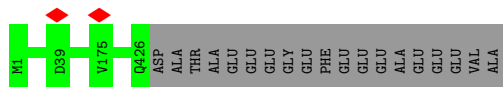

• Molecule 43: Tubulin beta-4B chain

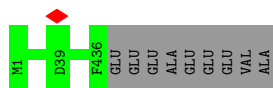

• Molecule 43: Tubulin beta-4B chain

Chain LX:  96%



- Molecule 43: Tubulin beta-4B chain

Chain LZ:  98%

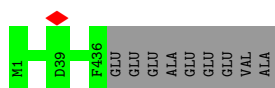

- Molecule 43: Tubulin beta-4B chain

Chain MD:  96%

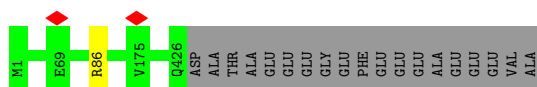

- Molecule 43: Tubulin beta-4B chain

Chain MF:  96%

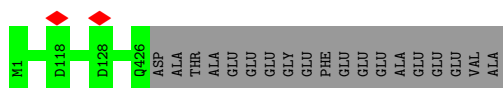

- Molecule 43: Tubulin beta-4B chain

Chain MH:  96%

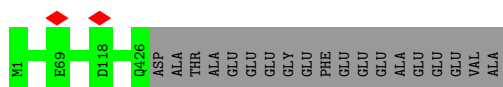

- Molecule 43: Tubulin beta-4B chain

Chain MJ:  96%

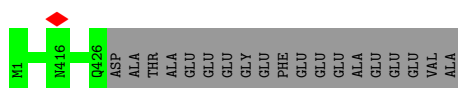

- Molecule 43: Tubulin beta-4B chain

Chain ML:  96%

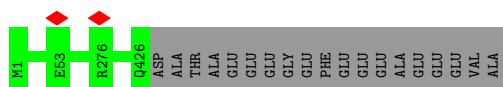

- Molecule 43: Tubulin beta-4B chain

Chain MN:  96%

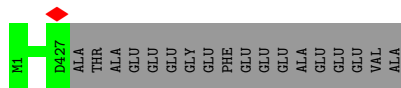

- Molecule 43: Tubulin beta-4B chain

Chain MP:  96%

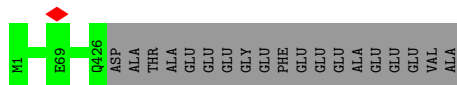

- Molecule 43: Tubulin beta-4B chain

Chain MR:  96%

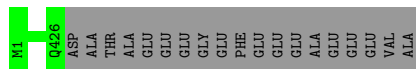

- Molecule 43: Tubulin beta-4B chain

Chain MT:  96%

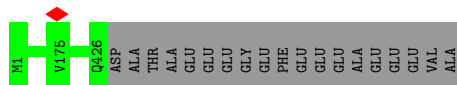

- Molecule 43: Tubulin beta-4B chain

Chain MV:  96%

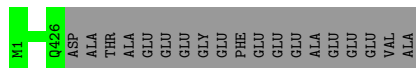

- Molecule 43: Tubulin beta-4B chain

Chain MX:  96%

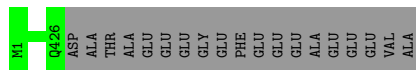

- Molecule 43: Tubulin beta-4B chain

Chain MZ:  96%

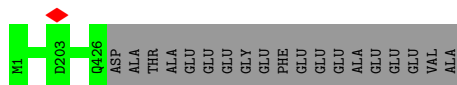

• Molecule 43: Tubulin beta-4B chain

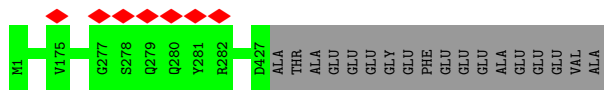

• Molecule 43: Tubulin beta-4B chain

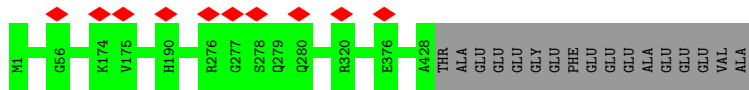

• Molecule 43: Tubulin beta-4B chain

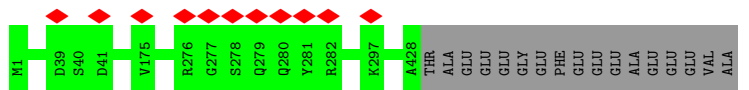

• Molecule 43: Tubulin beta-4B chain

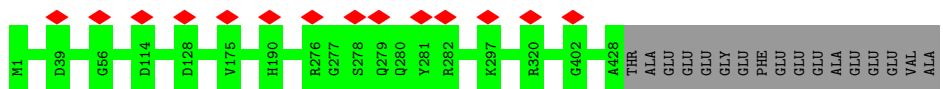

• Molecule 43: Tubulin beta-4B chain

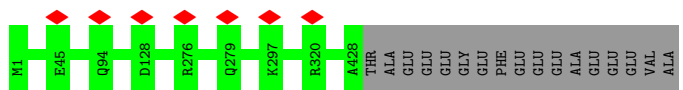

• Molecule 43: Tubulin beta-4B chain

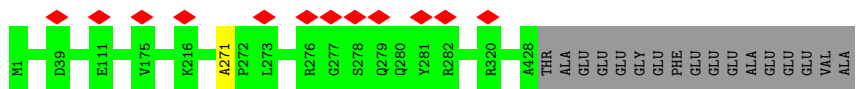

• Molecule 43: Tubulin beta-4B chain



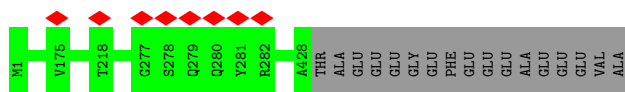

- Molecule 43: Tubulin beta-4B chain

Chain NP: 96%

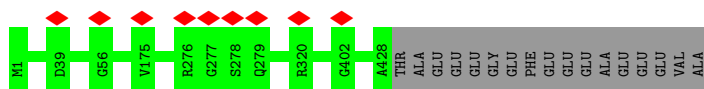

- Molecule 43: Tubulin beta-4B chain

Chain NR: 96%

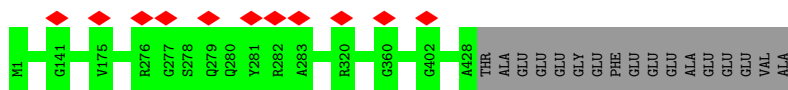

- Molecule 43: Tubulin beta-4B chain

Chain NT: 96%

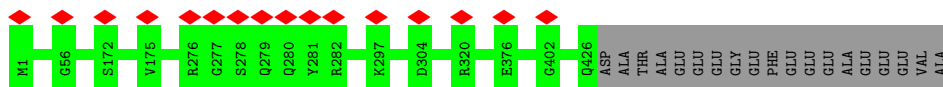

- Molecule 43: Tubulin beta-4B chain

Chain NV: 96%

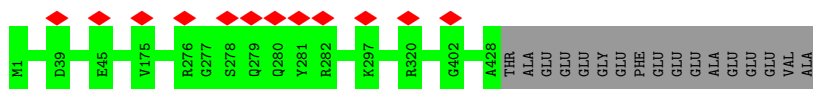

- Molecule 43: Tubulin beta-4B chain

Chain NX: 96%

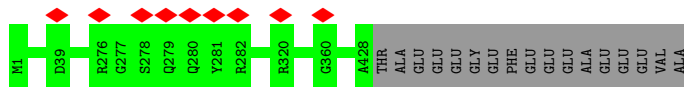

- Molecule 43: Tubulin beta-4B chain

Chain NZ: 97%

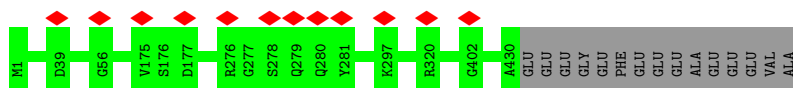

- Molecule 43: Tubulin beta-4B chain

Chain OB:  96%

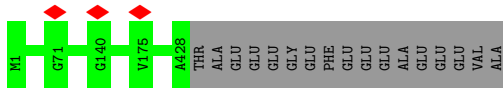

• Molecule 43: Tubulin beta-4B chain

Chain OD:  96%

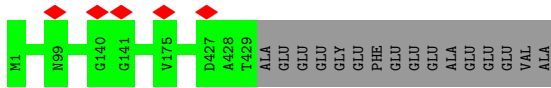

• Molecule 43: Tubulin beta-4B chain

Chain OF:  96%

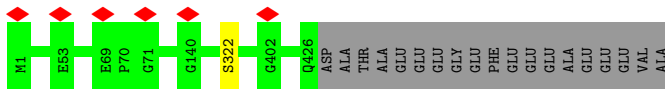

• Molecule 43: Tubulin beta-4B chain

Chain OH:  96%



• Molecule 43: Tubulin beta-4B chain

Chain OJ:  96%

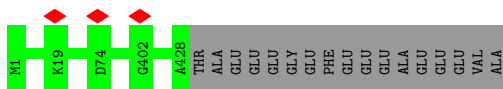

• Molecule 43: Tubulin beta-4B chain

Chain OL:  96%

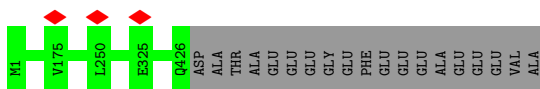

• Molecule 43: Tubulin beta-4B chain

Chain ON:  96%

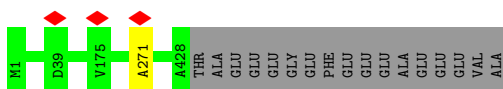

• Molecule 43: Tubulin beta-4B chain



• Molecule 43: Tubulin beta-4B chain

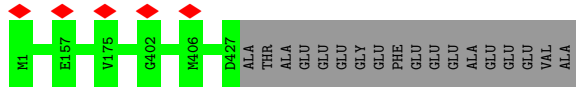

• Molecule 43: Tubulin beta-4B chain

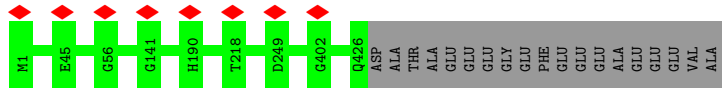

• Molecule 43: Tubulin beta-4B chain

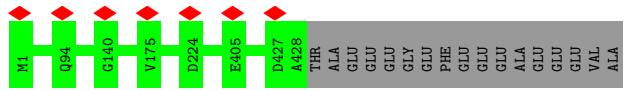

• Molecule 43: Tubulin beta-4B chain

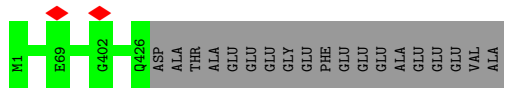

• Molecule 43: Tubulin beta-4B chain

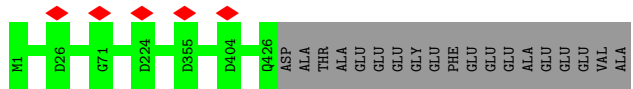

• Molecule 43: Tubulin beta-4B chain



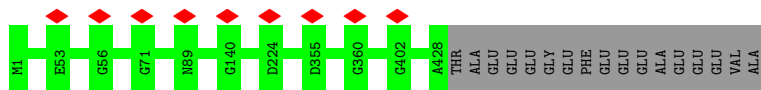

• Molecule 43: Tubulin beta-4B chain

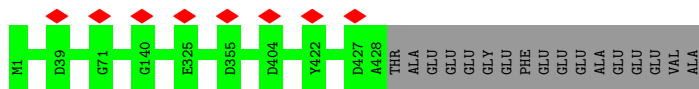

• Molecule 43: Tubulin beta-4B chain

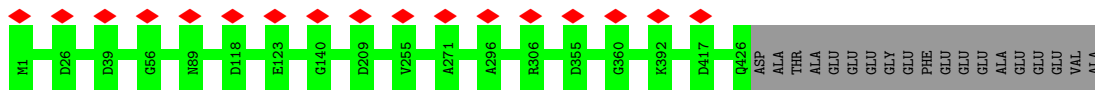

• Molecule 43: Tubulin beta-4B chain

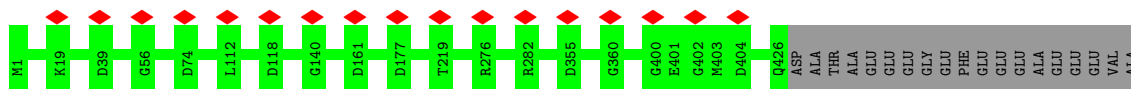

• Molecule 43: Tubulin beta-4B chain

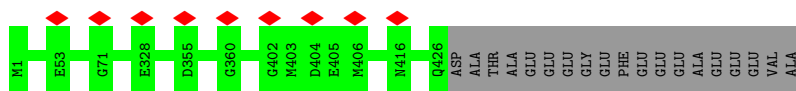

• Molecule 43: Tubulin beta-4B chain

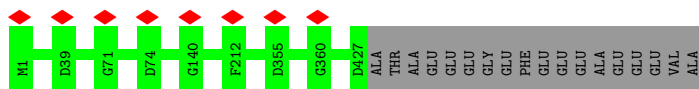

• Molecule 43: Tubulin beta-4B chain

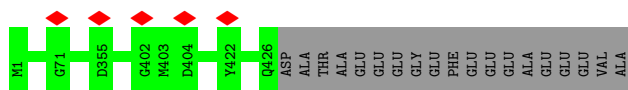

• Molecule 43: Tubulin beta-4B chain

Chain PR:  96%

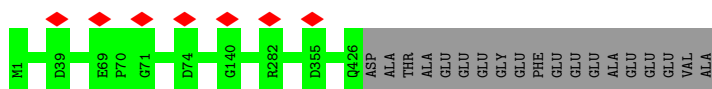

- Molecule 43: Tubulin beta-4B chain

Chain PT:  96%

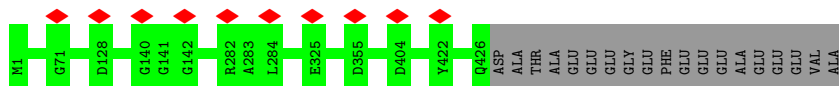

- Molecule 43: Tubulin beta-4B chain

Chain PV:  96%

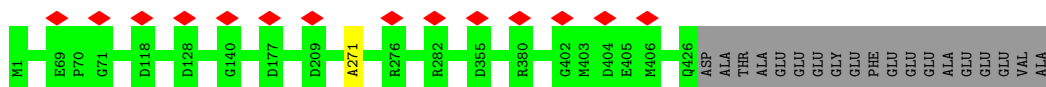

- Molecule 43: Tubulin beta-4B chain

Chain PX:  96%

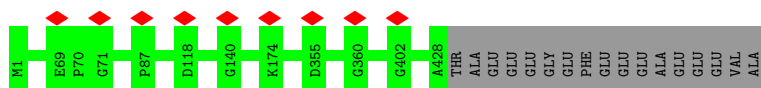

- Molecule 43: Tubulin beta-4B chain

Chain QB:  96%

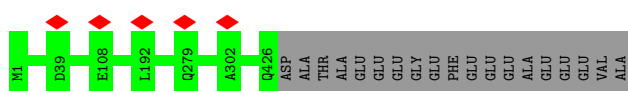

- Molecule 43: Tubulin beta-4B chain

Chain QD:  96%

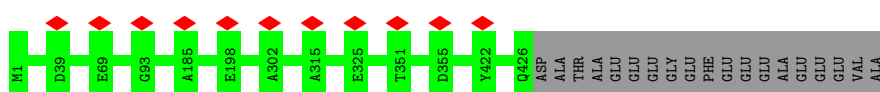

- Molecule 43: Tubulin beta-4B chain

Chain QF:  96%

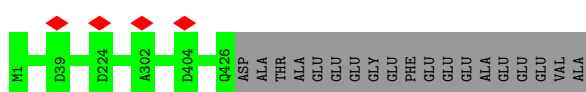

• Molecule 43: Tubulin beta-4B chain

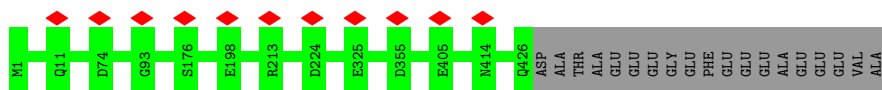

• Molecule 43: Tubulin beta-4B chain

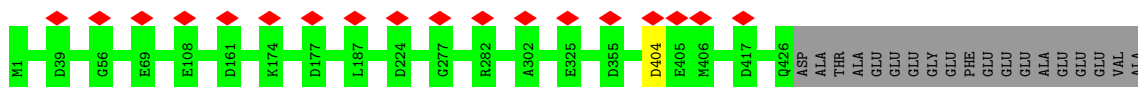

• Molecule 43: Tubulin beta-4B chain

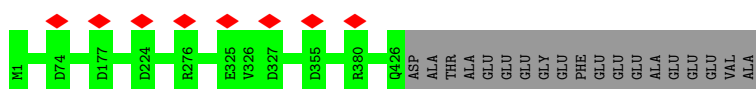

• Molecule 43: Tubulin beta-4B chain

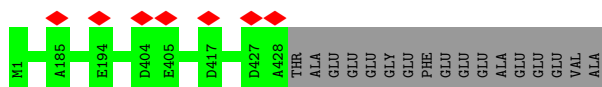

• Molecule 43: Tubulin beta-4B chain

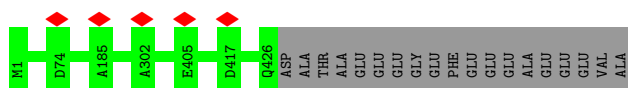

• Molecule 43: Tubulin beta-4B chain

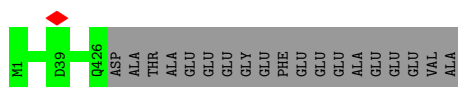

• Molecule 43: Tubulin beta-4B chain



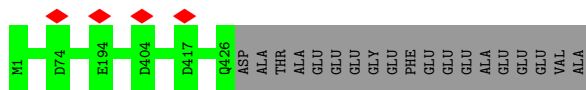

- Molecule 43: Tubulin beta-4B chain

Chain QV: 96%

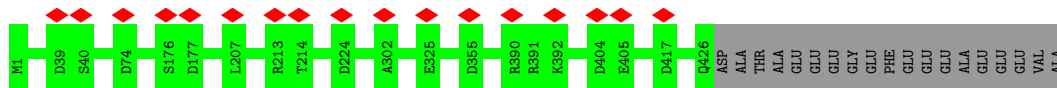

- Molecule 43: Tubulin beta-4B chain

Chain QX: 96%

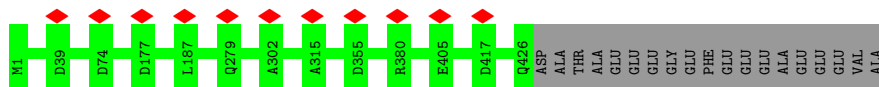

- Molecule 43: Tubulin beta-4B chain

Chain RB: 96%

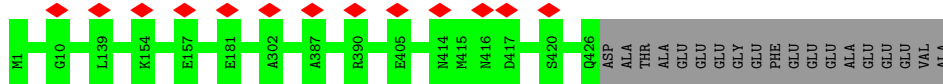

- Molecule 43: Tubulin beta-4B chain

Chain RD: 96%

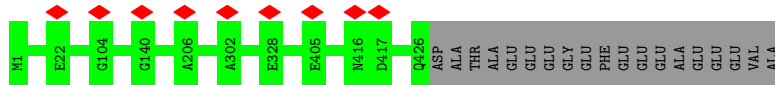

- Molecule 43: Tubulin beta-4B chain

Chain RF: 96%

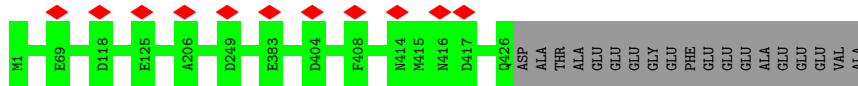

- Molecule 43: Tubulin beta-4B chain

Chain RH: 96%

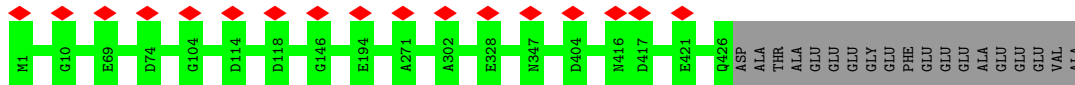

- Molecule 43: Tubulin beta-4B chain

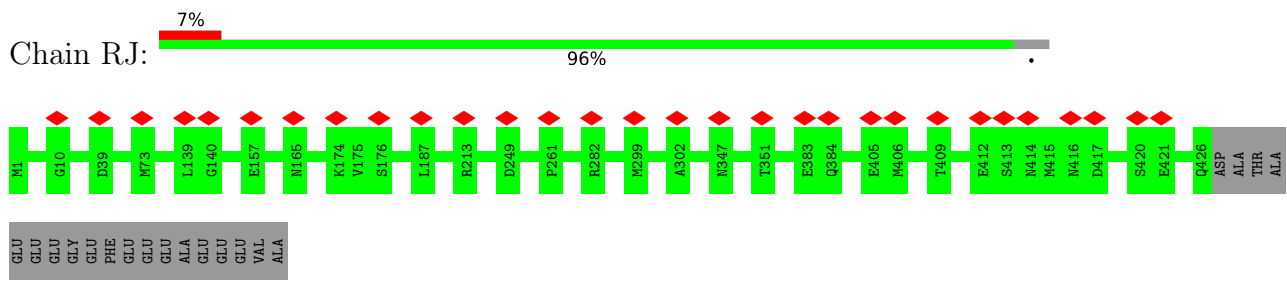

• Molecule 43: Tubulin beta-4B chain

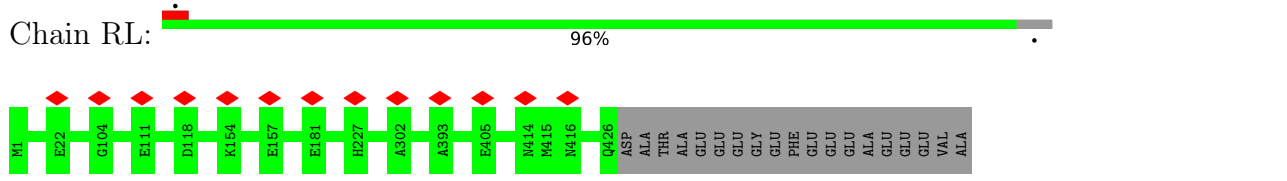

• Molecule 43: Tubulin beta-4B chain

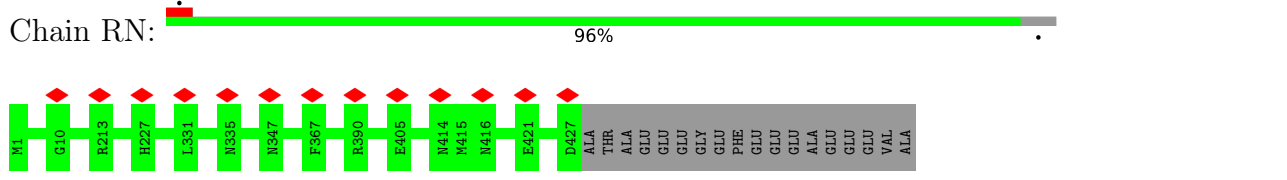

• Molecule 43: Tubulin beta-4B chain

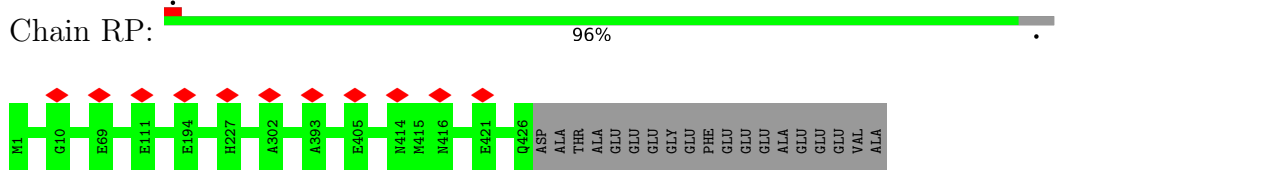

• Molecule 43: Tubulin beta-4B chain

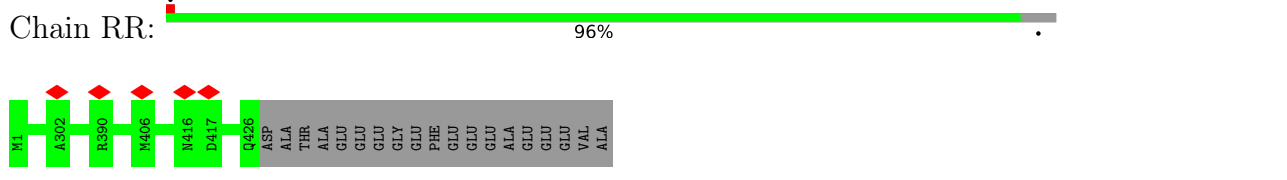

• Molecule 43: Tubulin beta-4B chain

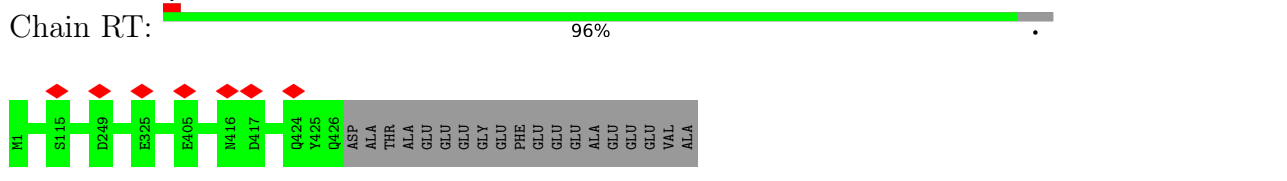

• Molecule 43: Tubulin beta-4B chain

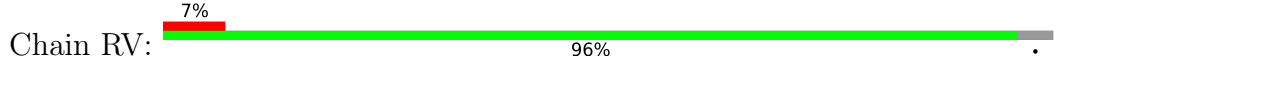

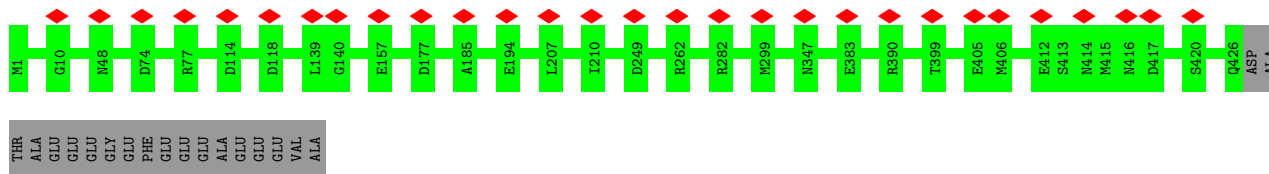

- Molecule 43: Tubulin beta-4B chain

Chain RX: 96%

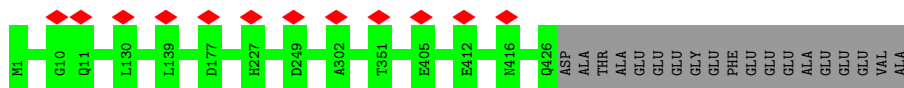

- Molecule 43: Tubulin beta-4B chain

Chain SB: 96%

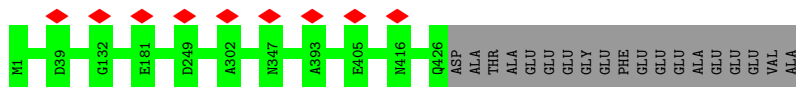

- Molecule 43: Tubulin beta-4B chain

Chain SD: 96%

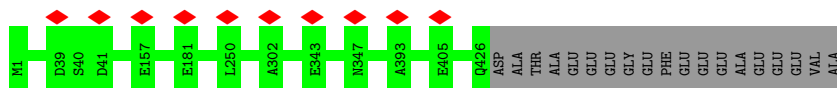

- Molecule 43: Tubulin beta-4B chain

Chain SF: 96%

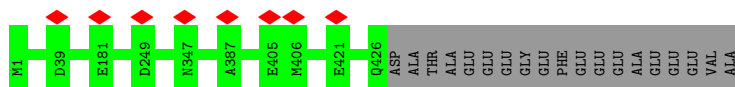

- Molecule 43: Tubulin beta-4B chain

Chain SH: 96%

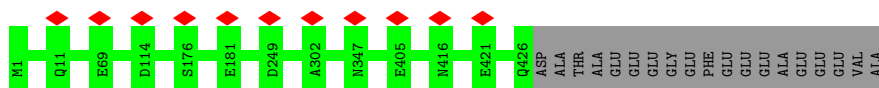

- Molecule 43: Tubulin beta-4B chain

Chain SJ: 5% 96%

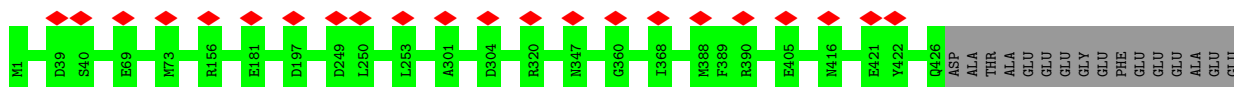

GLU
VAL
ALA

- Molecule 43: Tubulin beta-4B chain

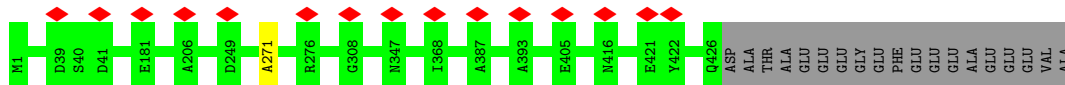

- Molecule 43: Tubulin beta-4B chain

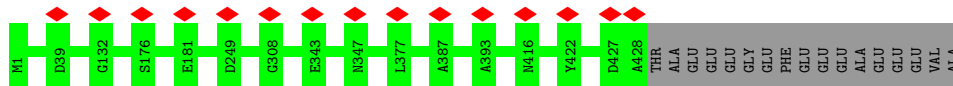

- Molecule 43: Tubulin beta-4B chain

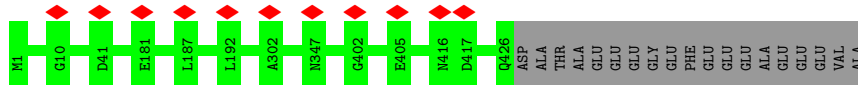

- Molecule 43: Tubulin beta-4B chain

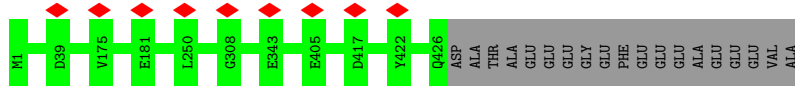

- Molecule 43: Tubulin beta-4B chain

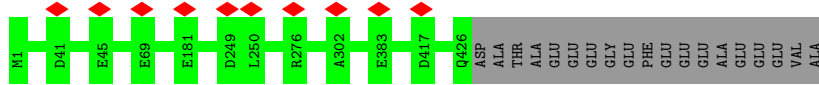

- Molecule 43: Tubulin beta-4B chain

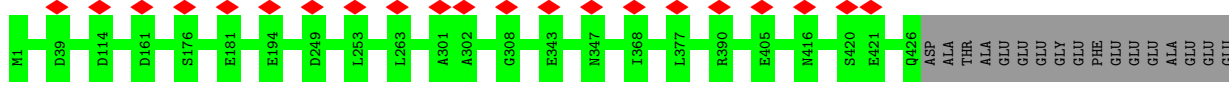

VAL
ALA

- Molecule 43: Tubulin beta-4B chain

Chain SX:  96%

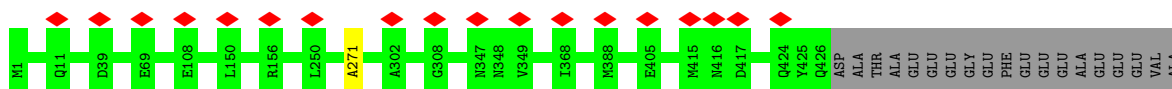

• Molecule 43: Tubulin beta-4B chain

Chain TB:  96%



• Molecule 43: Tubulin beta-4B chain

Chain TD:  96%

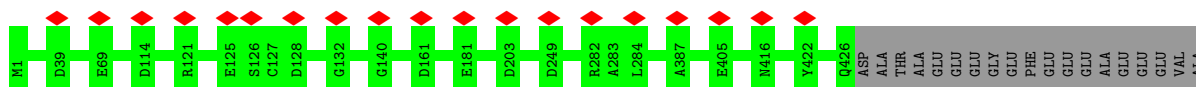

• Molecule 43: Tubulin beta-4B chain

Chain TF:  96%

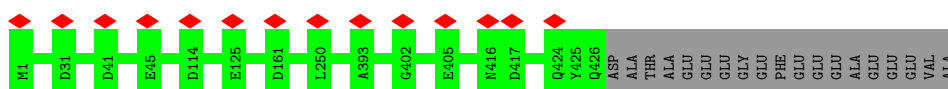

• Molecule 43: Tubulin beta-4B chain

Chain TH:  96%

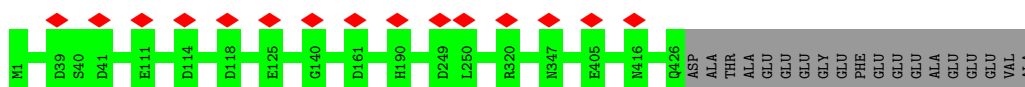

• Molecule 43: Tubulin beta-4B chain

Chain TJ:  96%

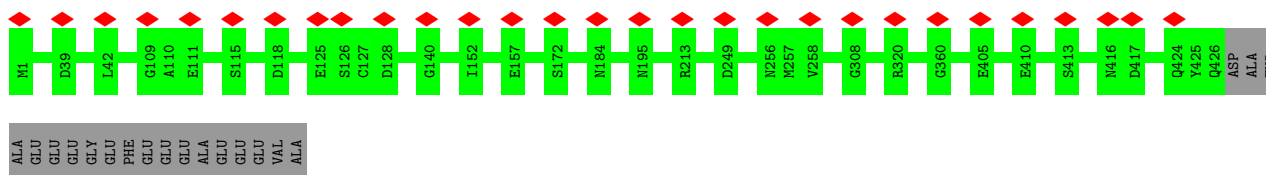

• Molecule 43: Tubulin beta-4B chain

Chain TL:  96%

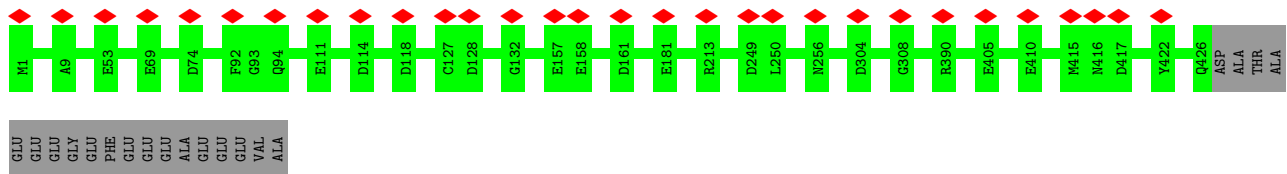

• Molecule 43: Tubulin beta-4B chain

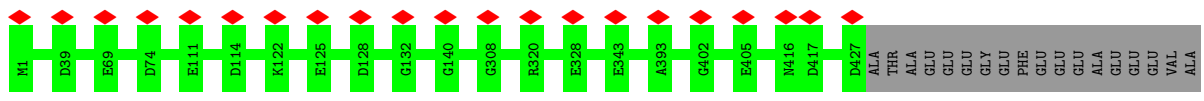

• Molecule 43: Tubulin beta-4B chain

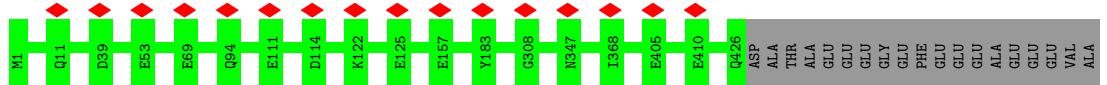

• Molecule 43: Tubulin beta-4B chain

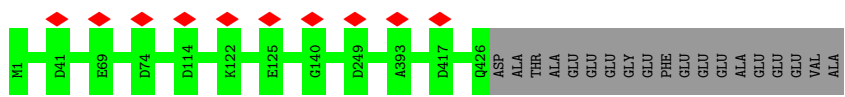

• Molecule 43: Tubulin beta-4B chain

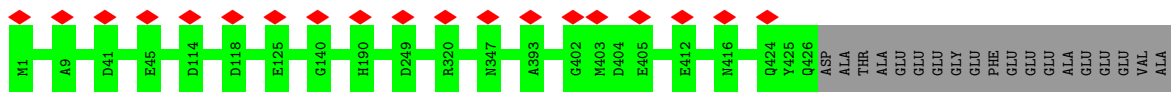

• Molecule 43: Tubulin beta-4B chain

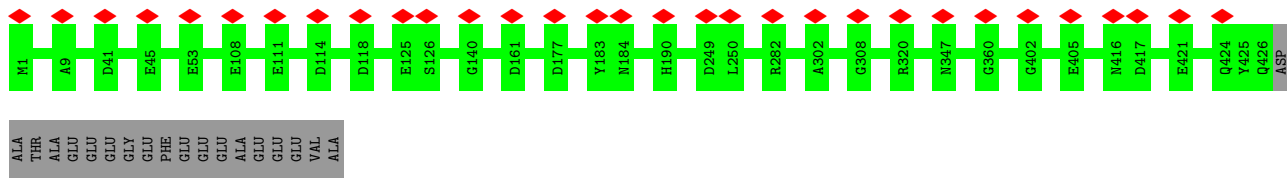

• Molecule 43: Tubulin beta-4B chain



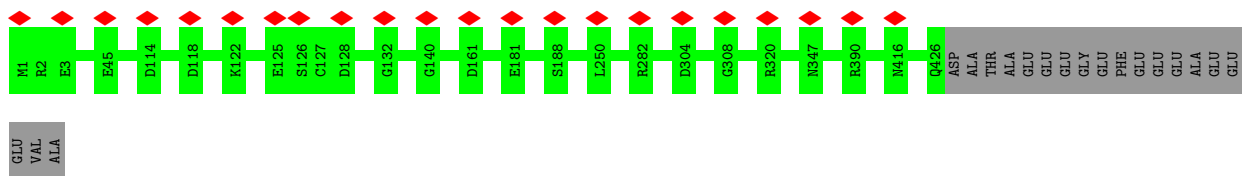

- Molecule 43: Tubulin beta-4B chain

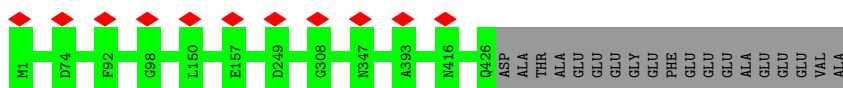

- Molecule 43: Tubulin beta-4B chain

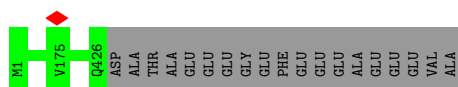

- Molecule 43: Tubulin beta-4B chain

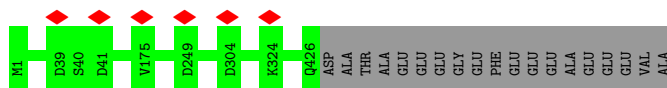

- Molecule 43: Tubulin beta-4B chain

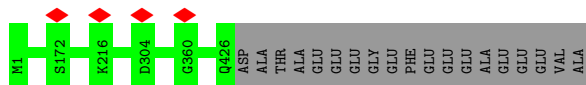

- Molecule 43: Tubulin beta-4B chain

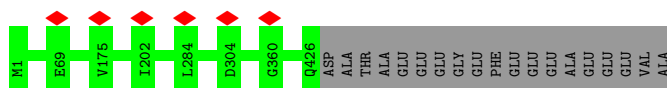

- Molecule 43: Tubulin beta-4B chain

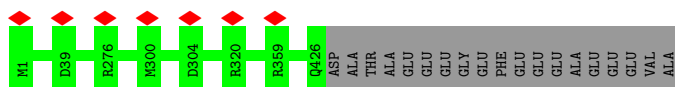

● Molecule 43: Tubulin beta-4B chain

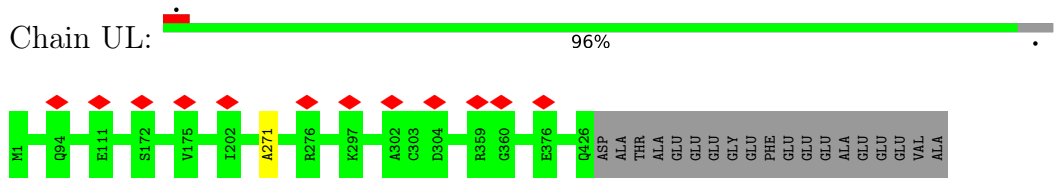

● Molecule 43: Tubulin beta-4B chain

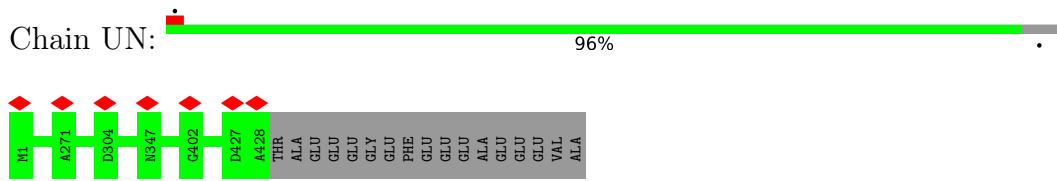

● Molecule 43: Tubulin beta-4B chain

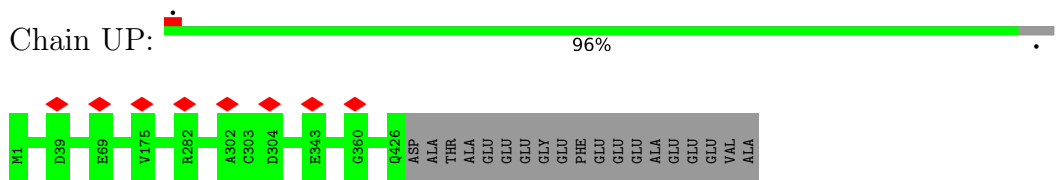

● Molecule 43: Tubulin beta-4B chain

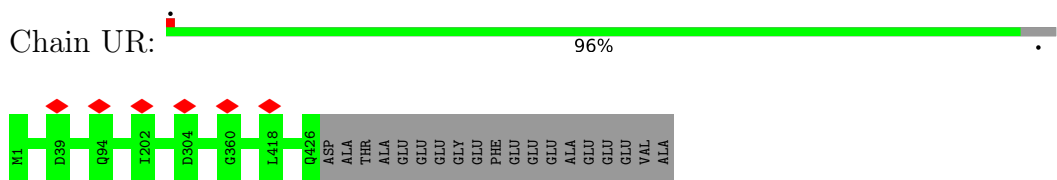

● Molecule 43: Tubulin beta-4B chain

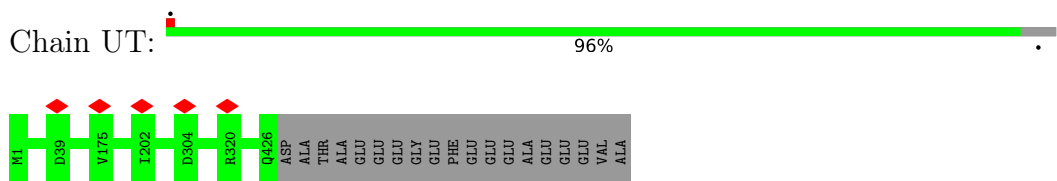

● Molecule 43: Tubulin beta-4B chain

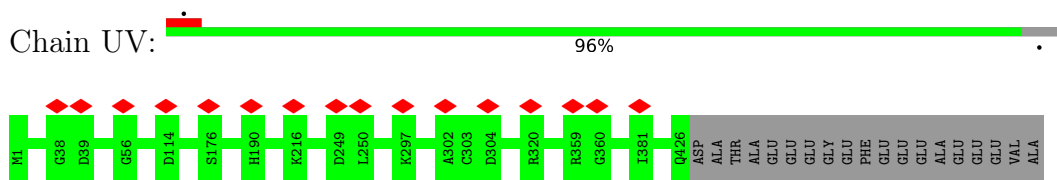

● Molecule 43: Tubulin beta-4B chain



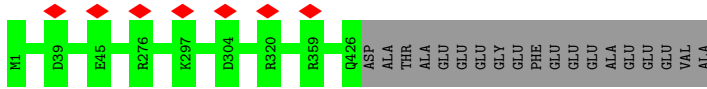

• Molecule 43: Tubulin beta-4B chain

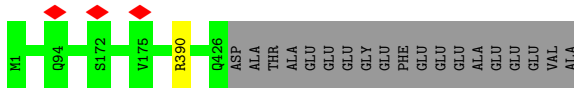

• Molecule 43: Tubulin beta-4B chain

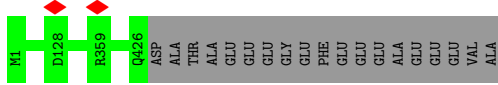

• Molecule 43: Tubulin beta-4B chain

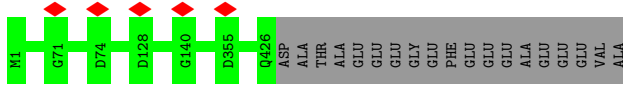

• Molecule 43: Tubulin beta-4B chain

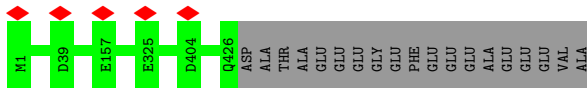

• Molecule 43: Tubulin beta-4B chain

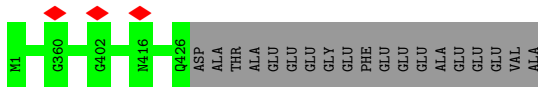

• Molecule 43: Tubulin beta-4B chain

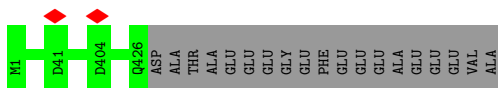

• Molecule 43: Tubulin beta-4B chain

Chain VL:  96%

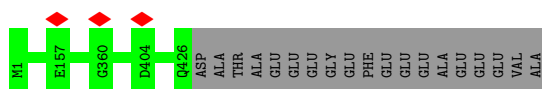

- Molecule 43: Tubulin beta-4B chain

Chain VN:  96%

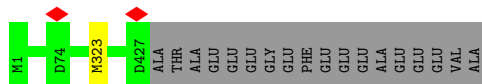

- Molecule 43: Tubulin beta-4B chain

Chain VP:  96%



- Molecule 43: Tubulin beta-4B chain

Chain VR:  96%

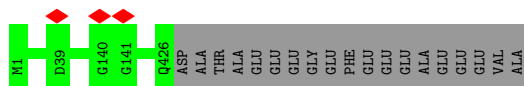

- Molecule 43: Tubulin beta-4B chain

Chain VT:  96%

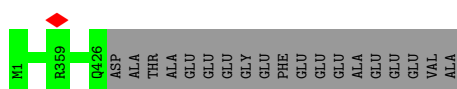

- Molecule 43: Tubulin beta-4B chain

Chain VV:  96%

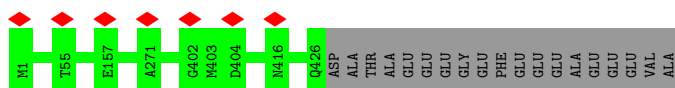

- Molecule 43: Tubulin beta-4B chain

Chain VX:  96%

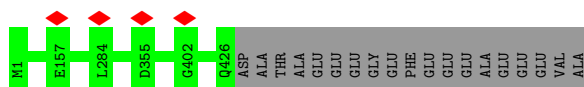

- Molecule 43: Tubulin beta-4B chain

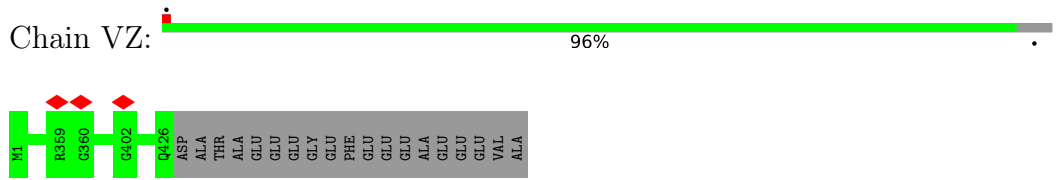

- Molecule 43: Tubulin beta-4B chain

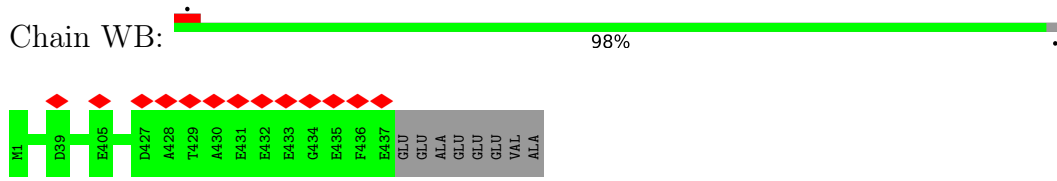

- Molecule 43: Tubulin beta-4B chain

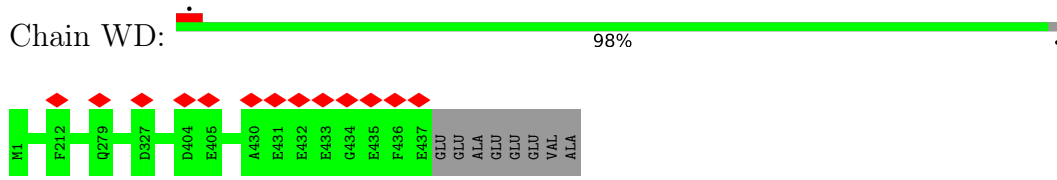

- Molecule 43: Tubulin beta-4B chain

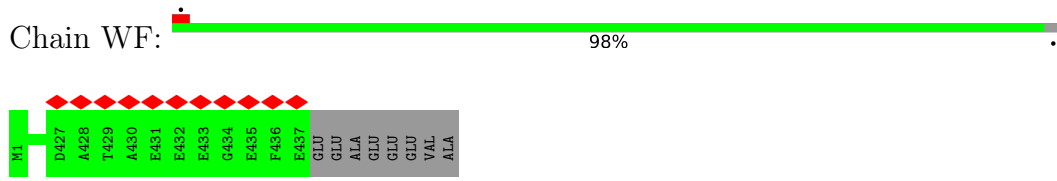

- Molecule 43: Tubulin beta-4B chain

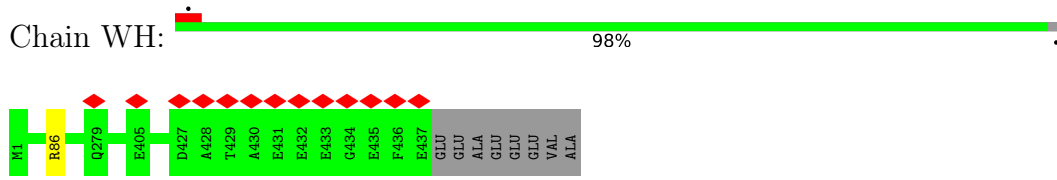

- Molecule 43: Tubulin beta-4B chain

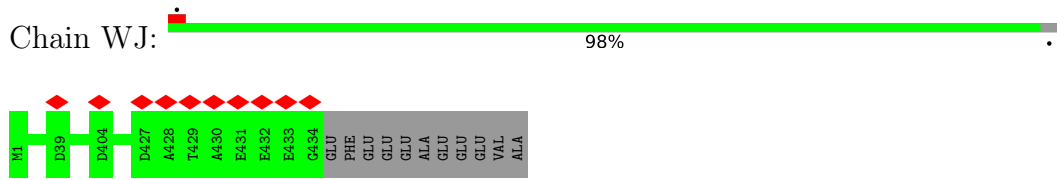

- Molecule 43: Tubulin beta-4B chain



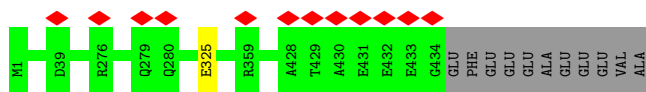

• Molecule 43: Tubulin beta-4B chain



• Molecule 43: Tubulin beta-4B chain

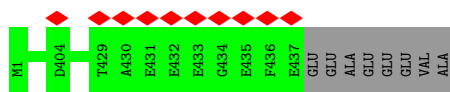

• Molecule 43: Tubulin beta-4B chain

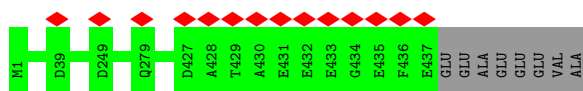

• Molecule 43: Tubulin beta-4B chain

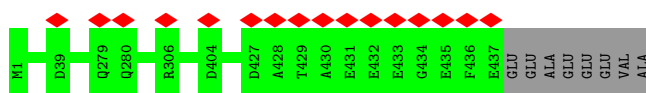

• Molecule 43: Tubulin beta-4B chain

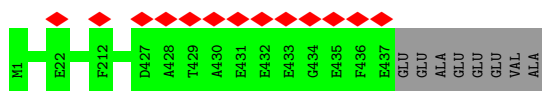

• Molecule 43: Tubulin beta-4B chain

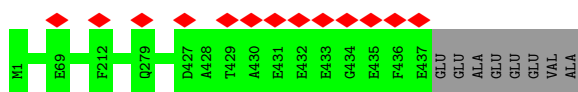

• Molecule 44: Radial spoke head protein 3 homolog

● Molecule 44: Radial spoke head protein 3 homolog

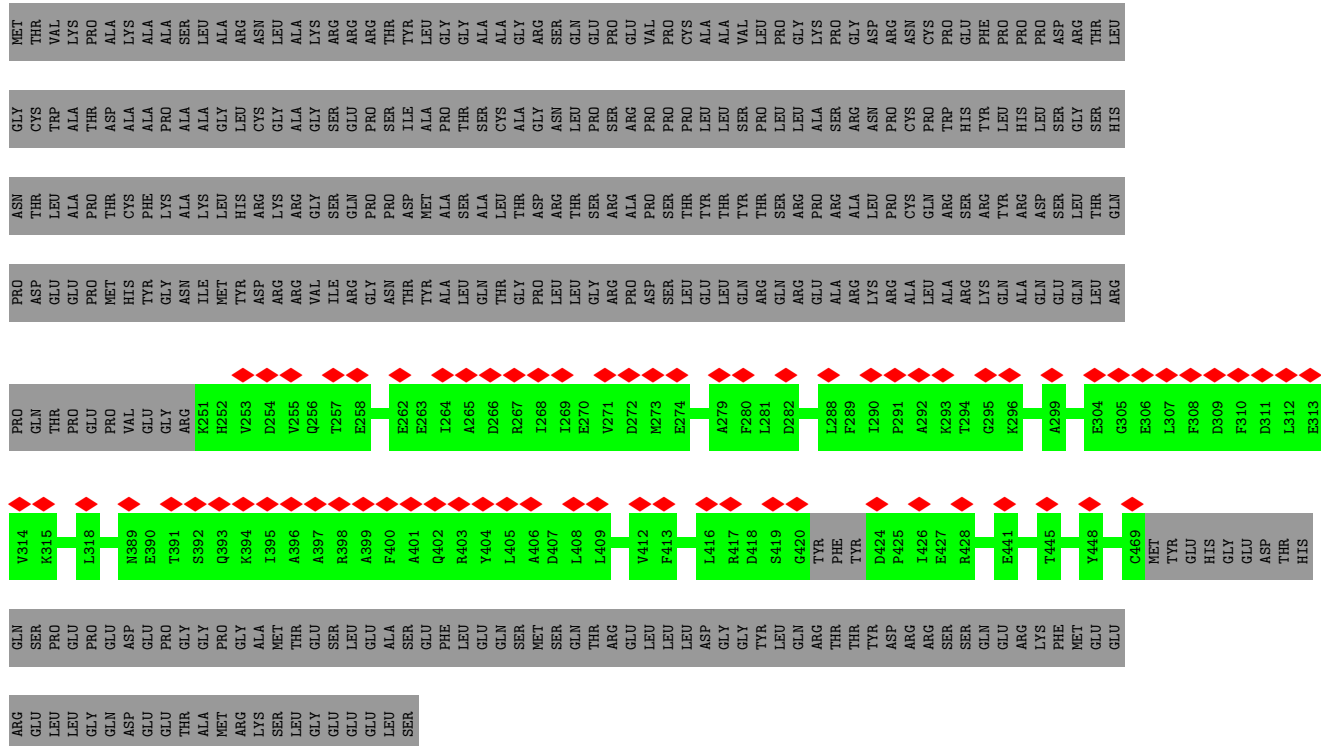

● Molecule 44: Radial spoke head protein 3 homolog

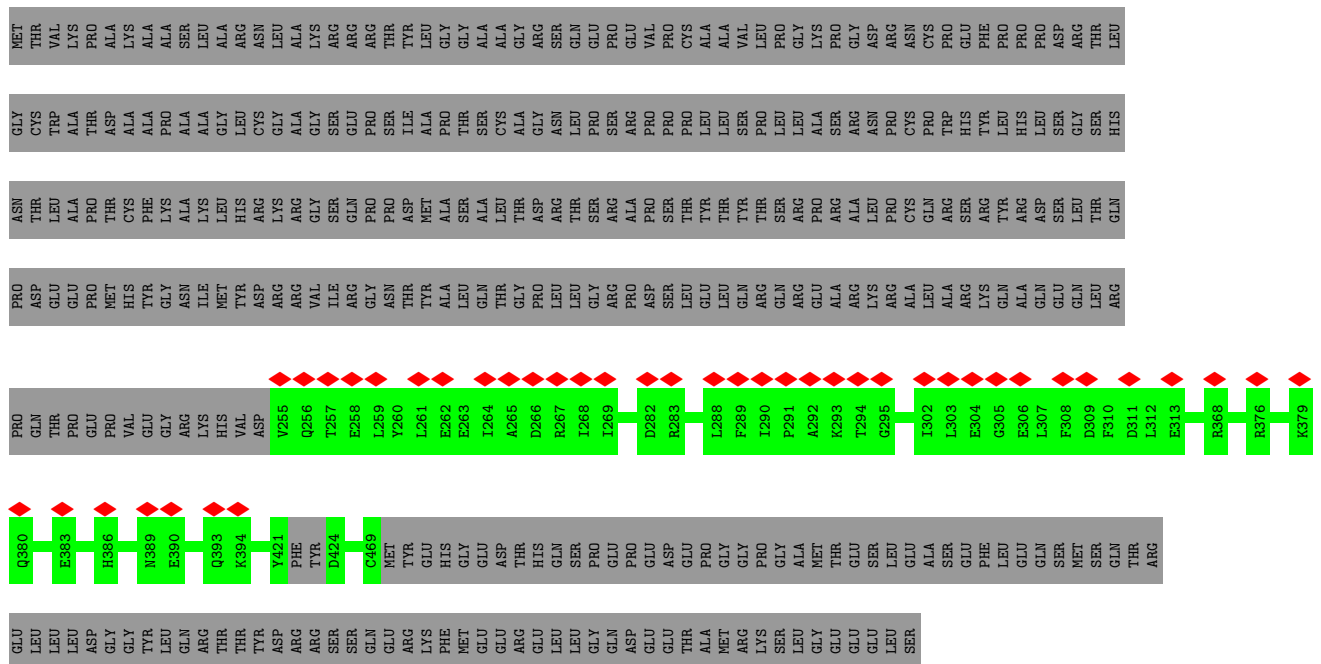

● Molecule 45: Radial spoke head protein 4 homolog A

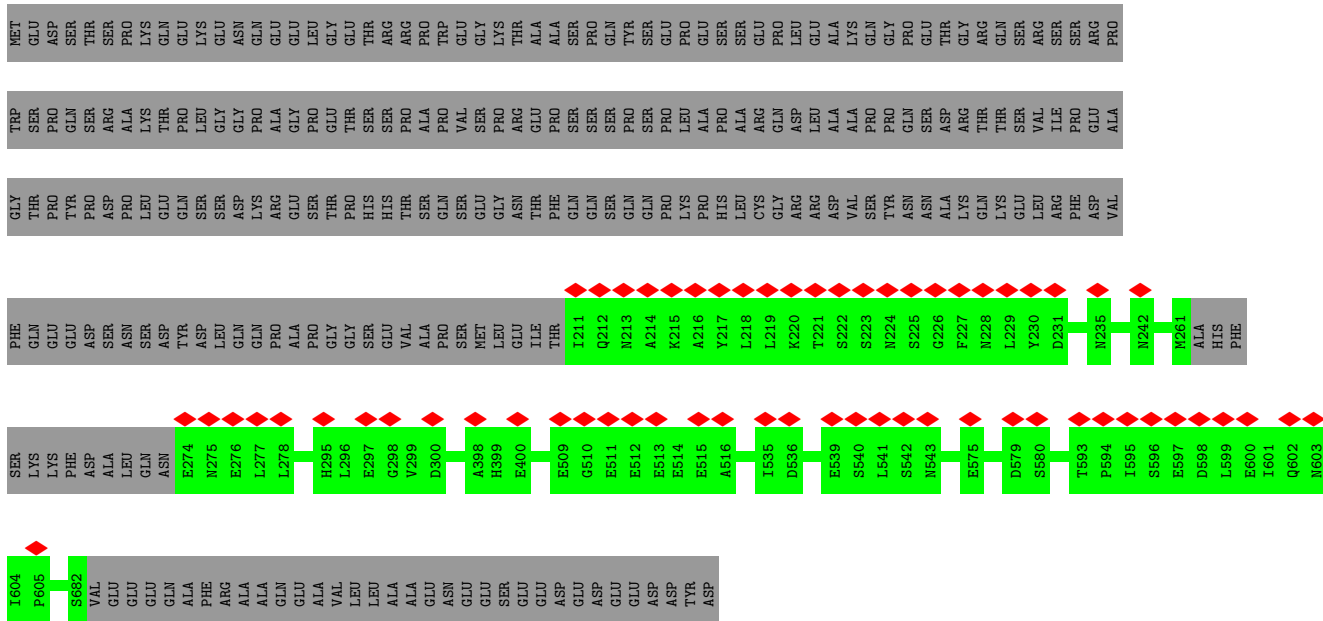

• Molecule 45: Radial spoke head protein 4 homolog A

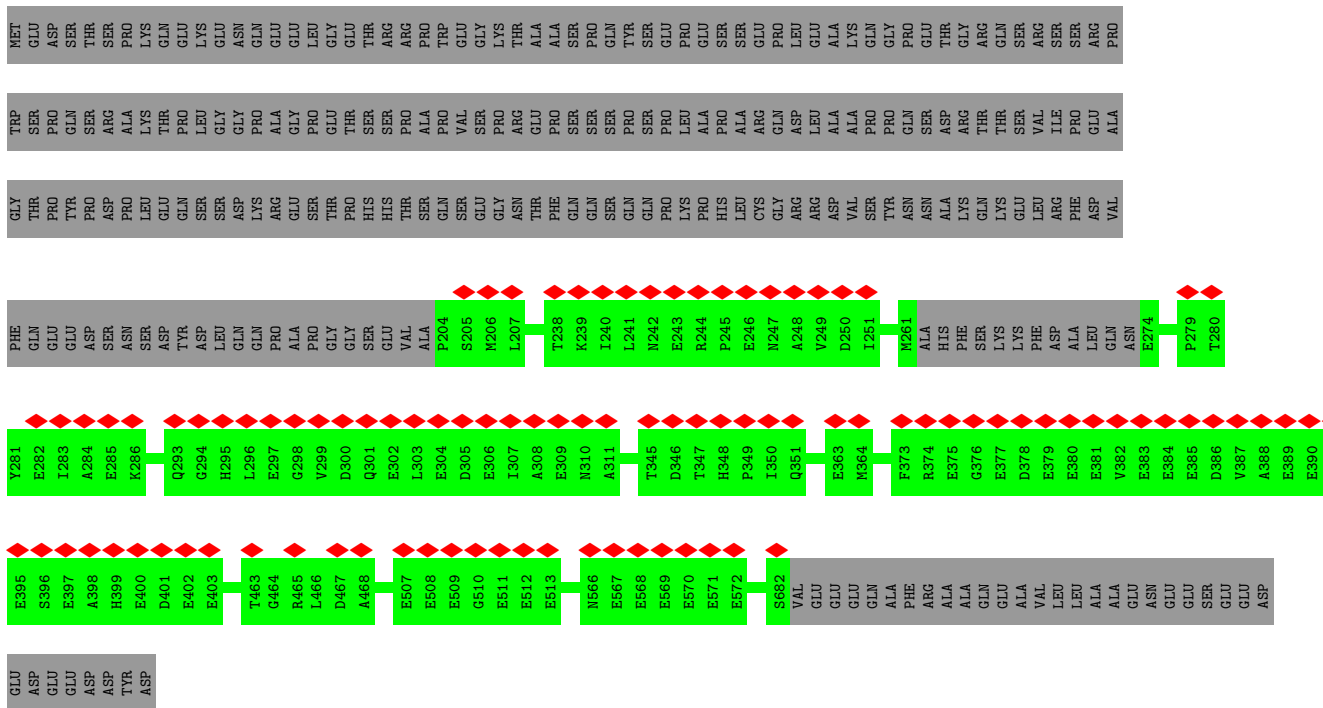

• Molecule 45: Radial spoke head protein 4 homolog A



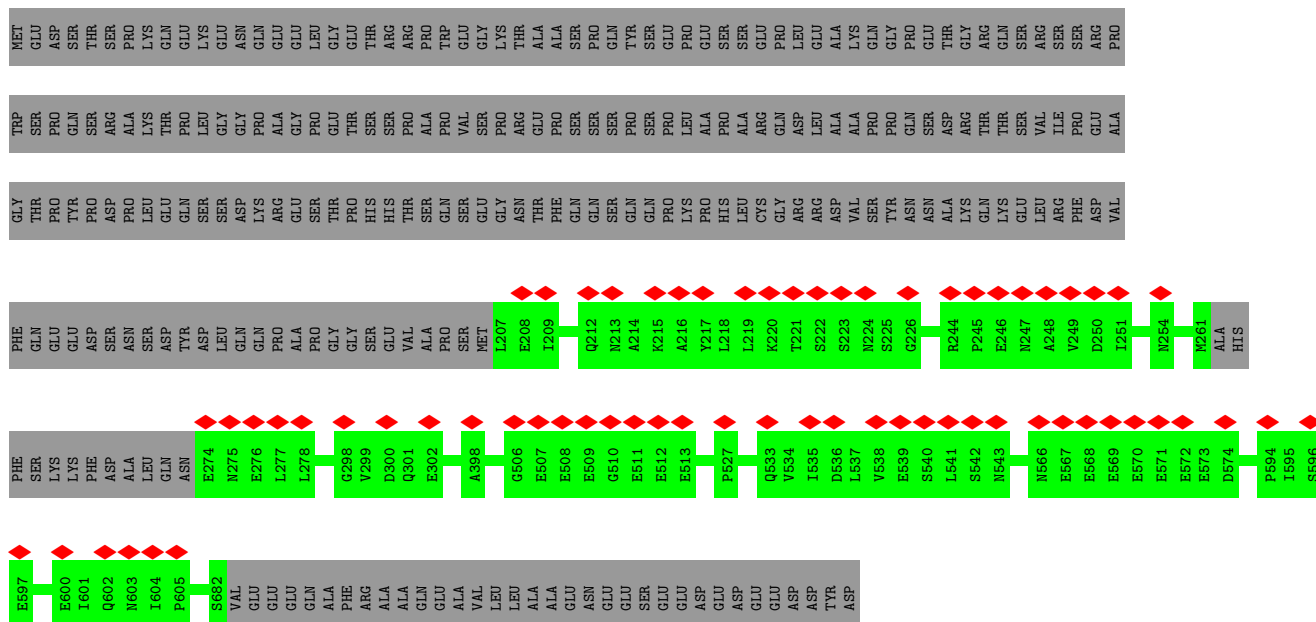

• Molecule 45: Radial spoke head protein 4 homolog A

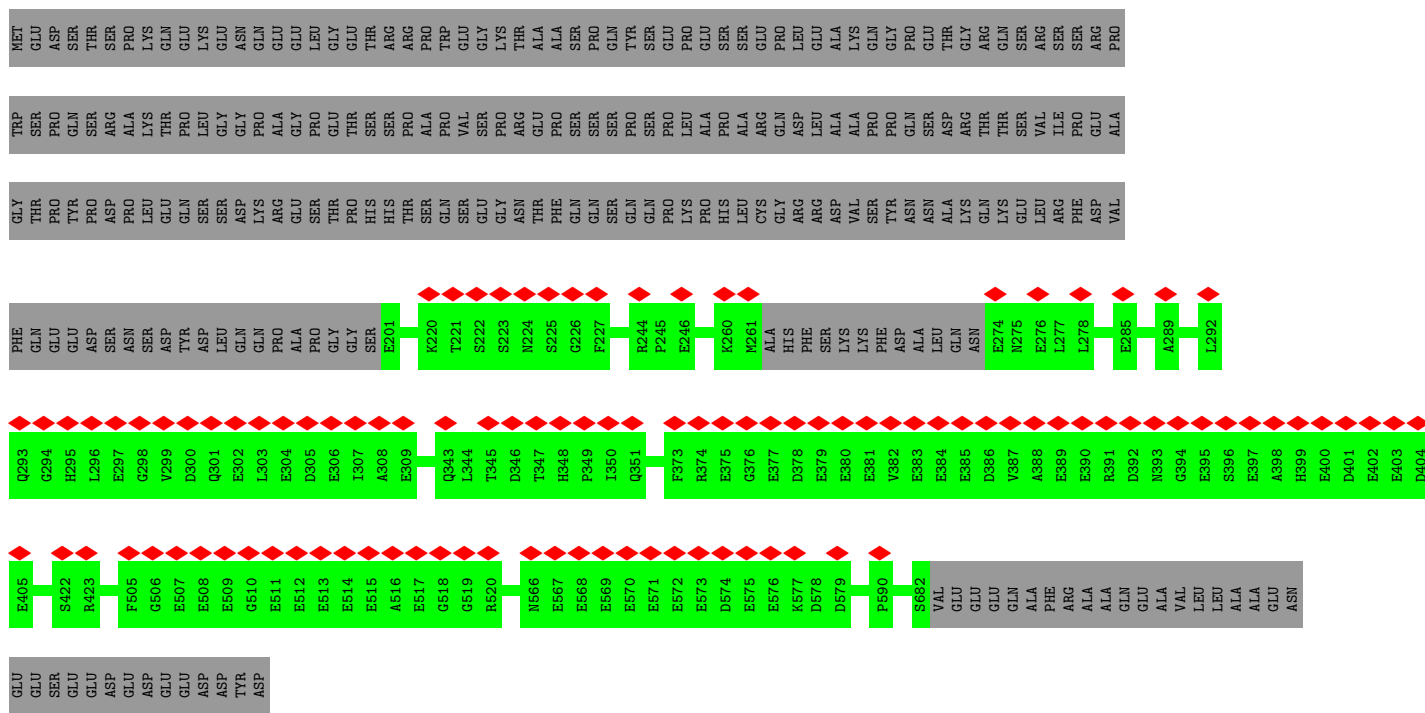

• Molecule 45: Radial spoke head protein 4 homolog A

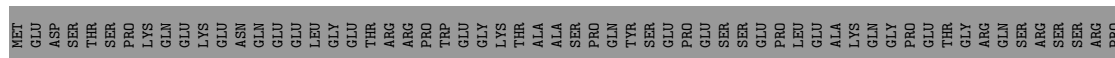

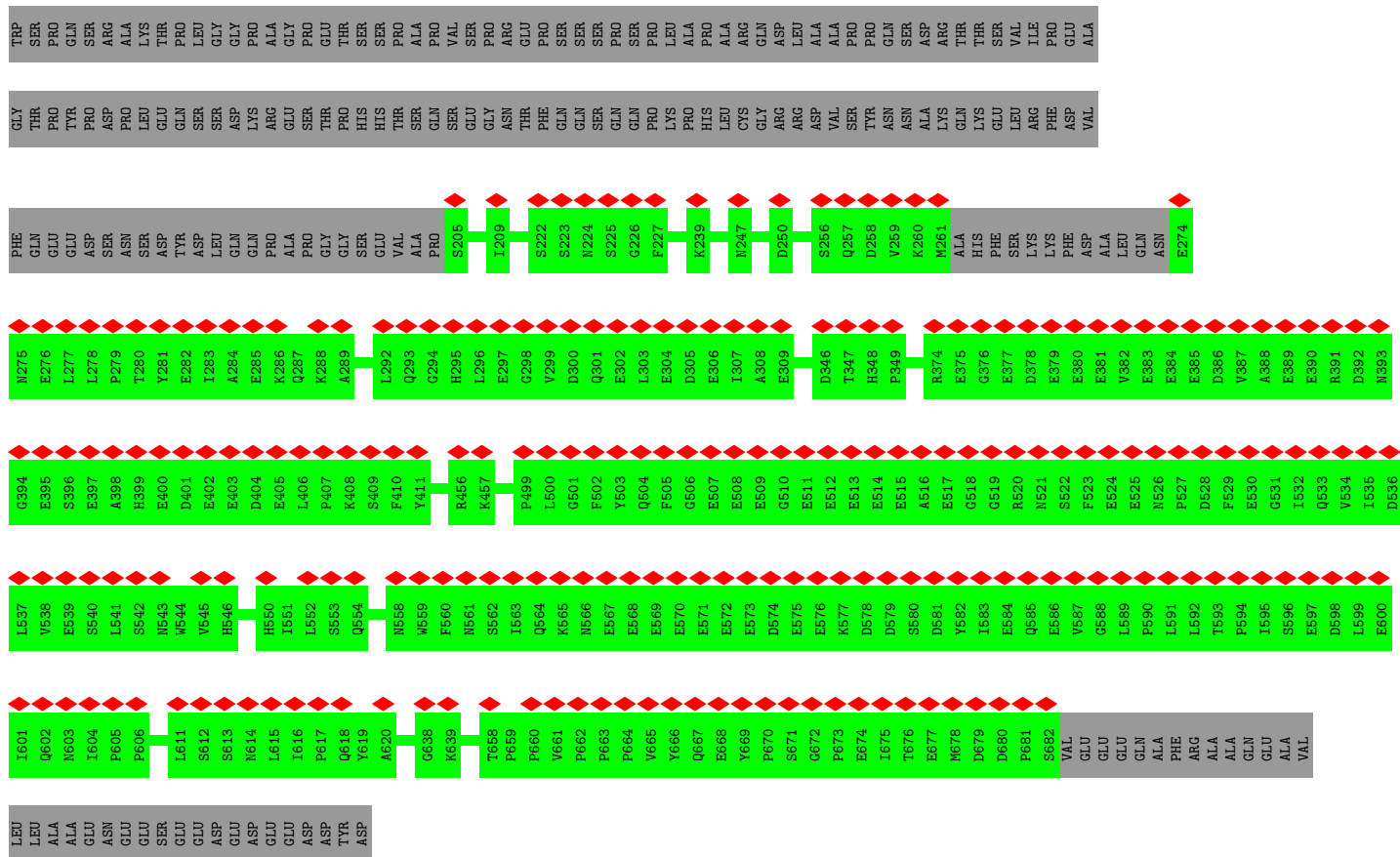

● Molecule 45: Radial spoke head protein 4 homolog A

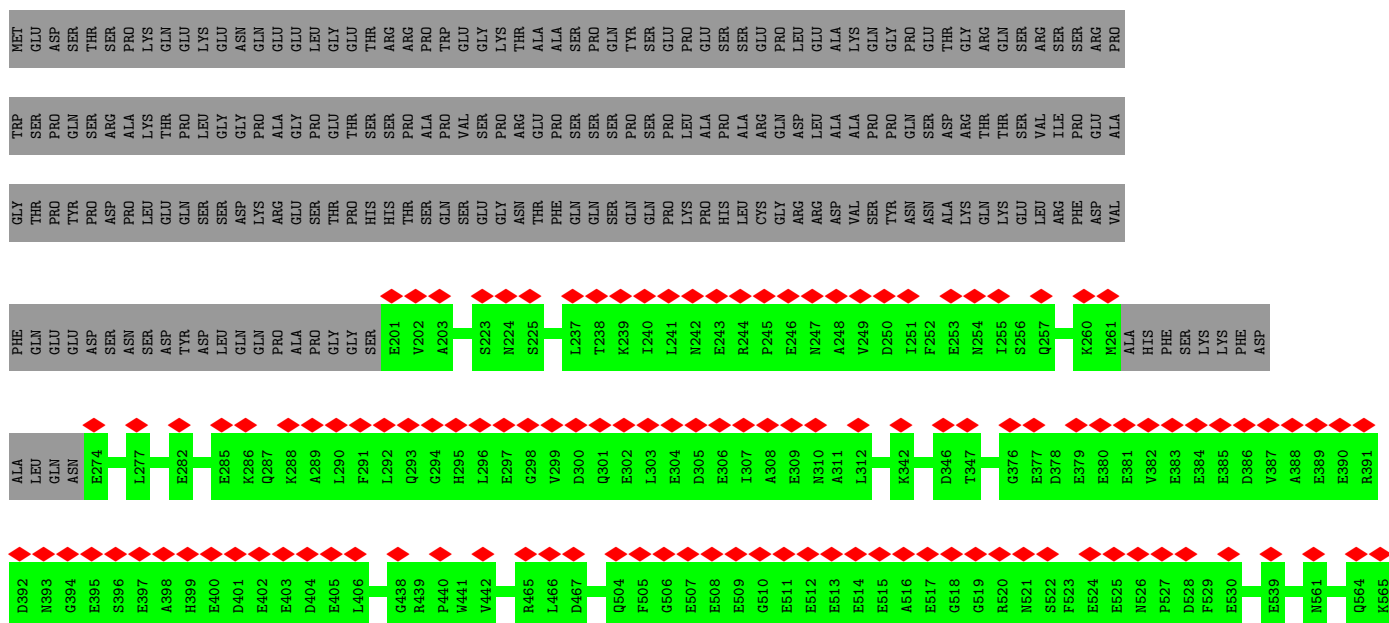

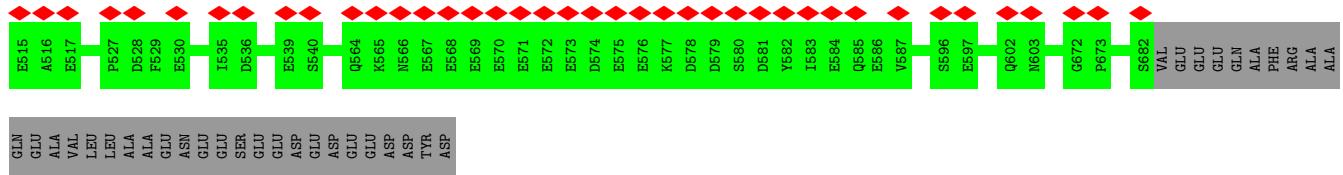

● Molecule 46: Sperm surface protein Sp17

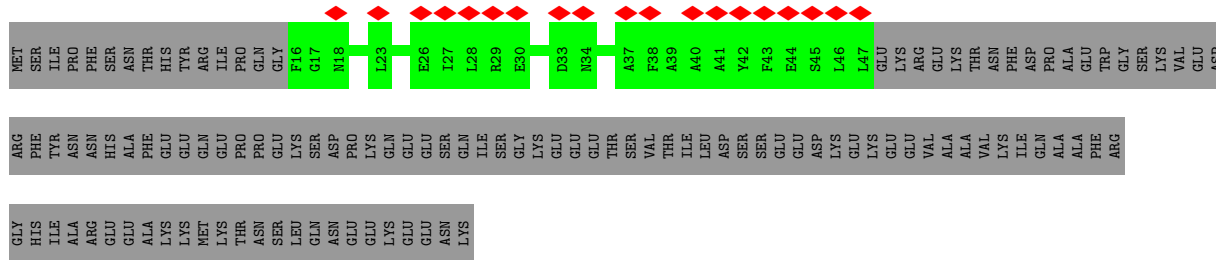

● Molecule 46: Sperm surface protein Sp17

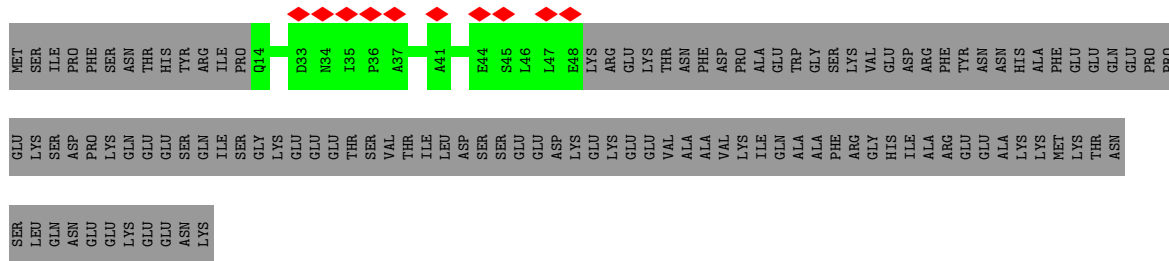

● Molecule 46: Sperm surface protein Sp17

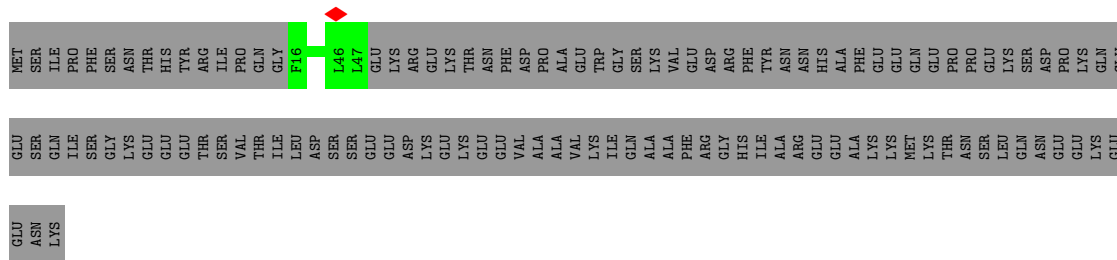

● Molecule 46: Sperm surface protein Sp17

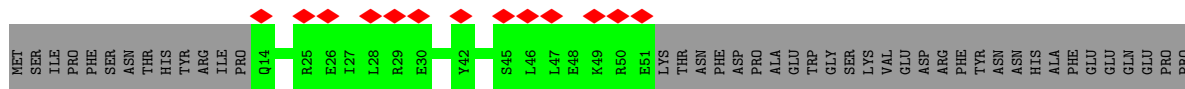

GLU LYS SER GLN ASP PRO GLU LYS GLN GLU GLU GLU GLN SER ILE SER GLY LYS GLU GLU GLU THR SER VAL THR ILE LEU LEU ASP SER SER SER SER GLU GLU ASP LYS LYS LYS VAL THR ILE LEU LEU ASP SER SER SER SER GLU GLU VAL VAL ALA ALA VAL LYS ILE GLN ALA ALA PHE ARG ARG HIS ILE ILE ARG ARG GLU GLU ALA ALA LYS LYS MET LYS THR ASN

SER LEU GLN ASN GLU LYS GLU GLU ASN LYS

• Molecule 47: Radial spoke head protein 9 homolog



• Molecule 47: Radial spoke head protein 9 homolog

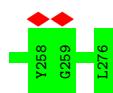
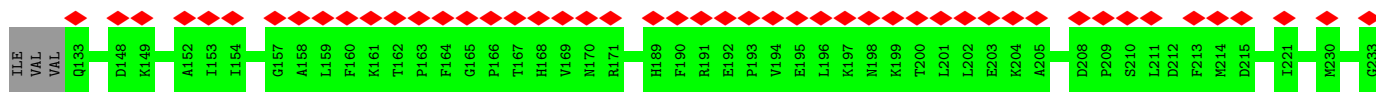
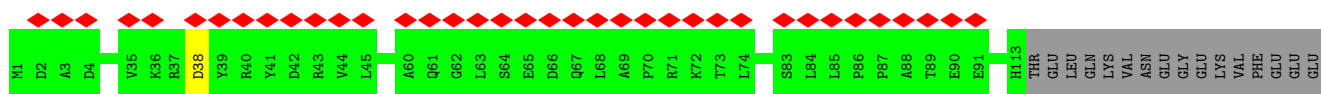
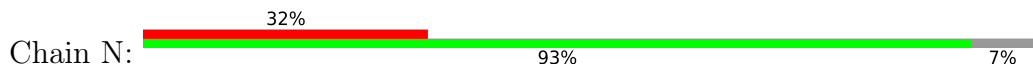

• Molecule 47: Radial spoke head protein 9 homolog

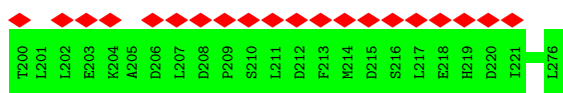
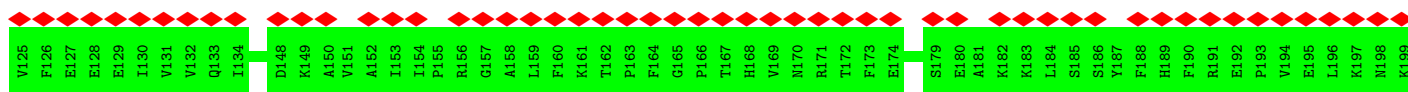
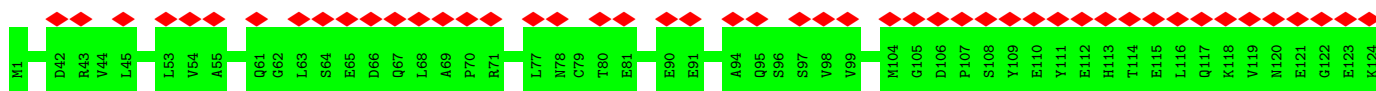
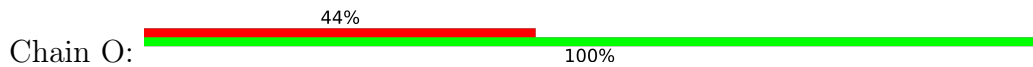

• Molecule 47: Radial spoke head protein 9 homolog

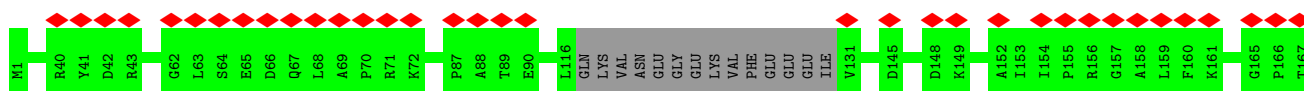

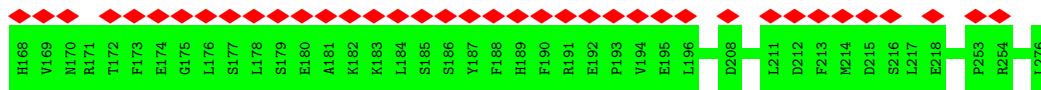

• Molecule 47: Radial spoke head protein 9 homolog

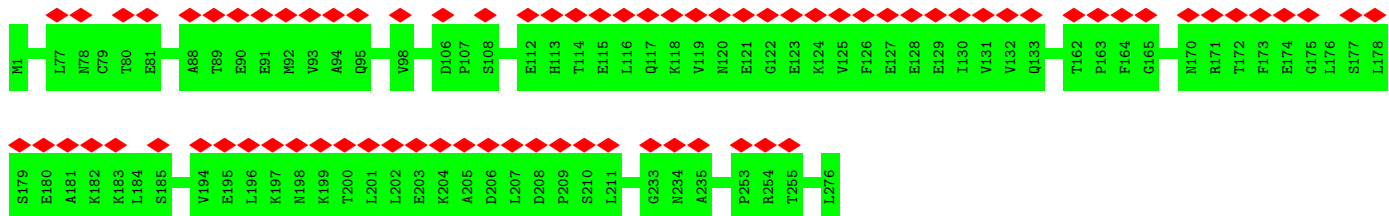

• Molecule 47: Radial spoke head protein 9 homolog

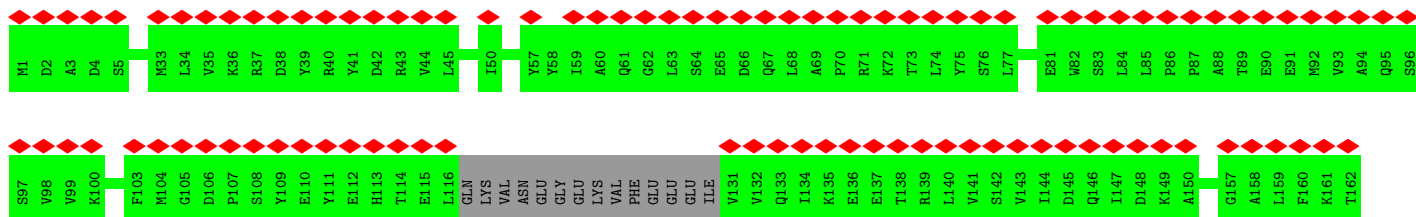
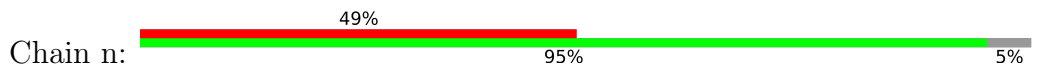

• Molecule 47: Radial spoke head protein 9 homolog

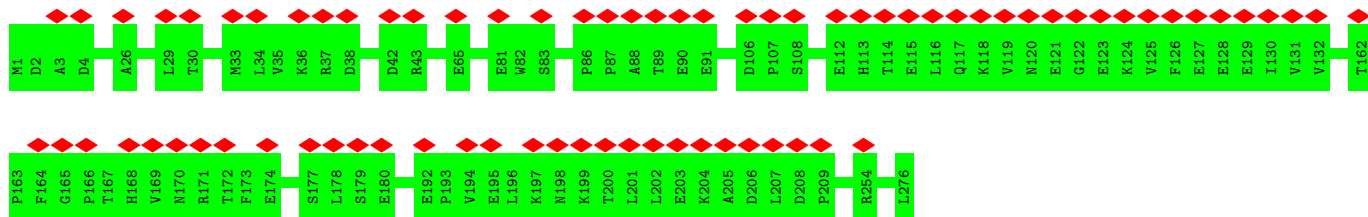

• Molecule 47: Radial spoke head protein 9 homolog

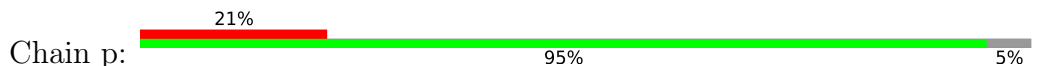

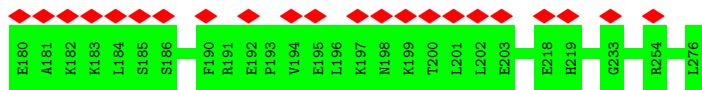

- Molecule 48: Ropporin-1-like protein

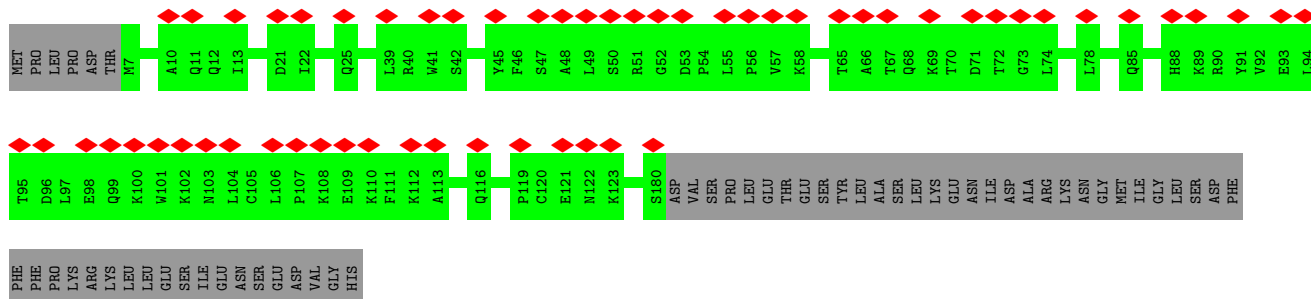
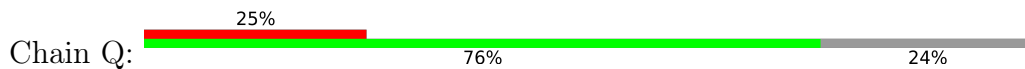

- Molecule 48: Ropporin-1-like protein

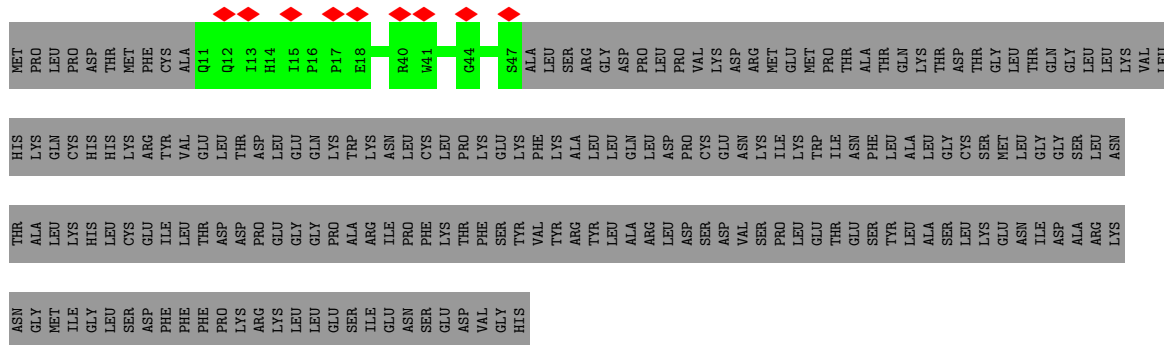

- Molecule 48: Ropporin-1-like protein

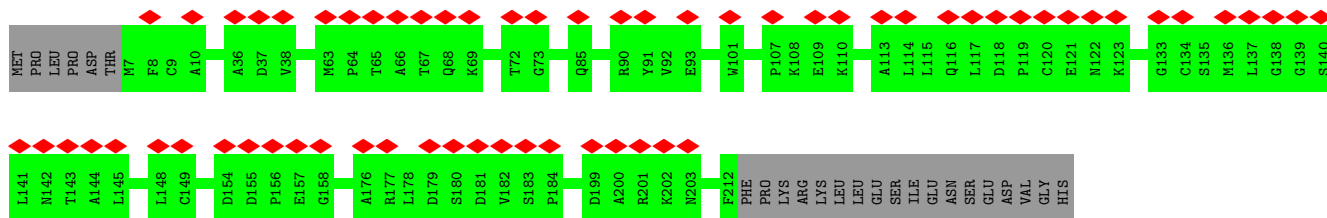
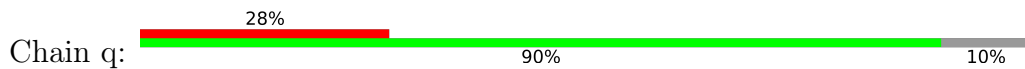

- Molecule 48: Ropporin-1-like protein

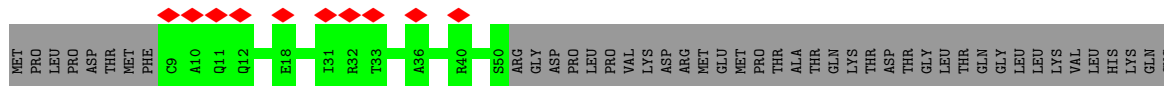

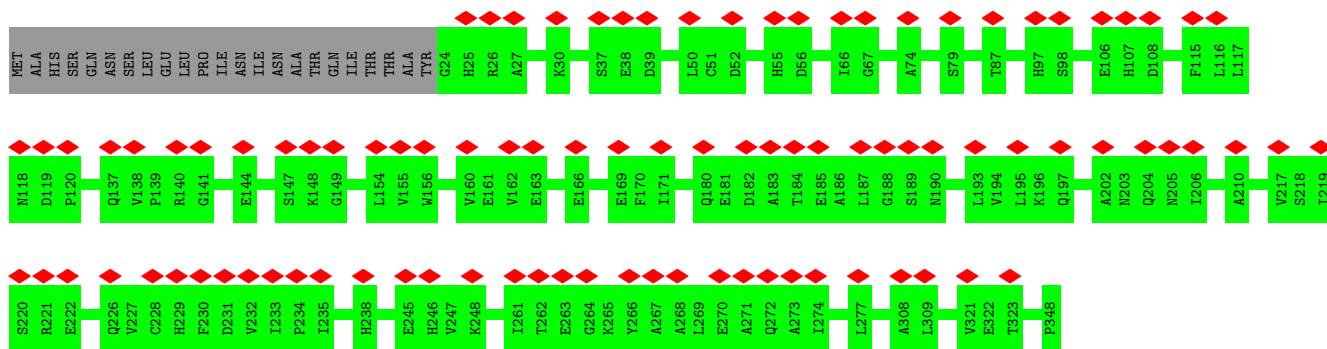

• Molecule 51: DnaJ homolog subfamily B member 13

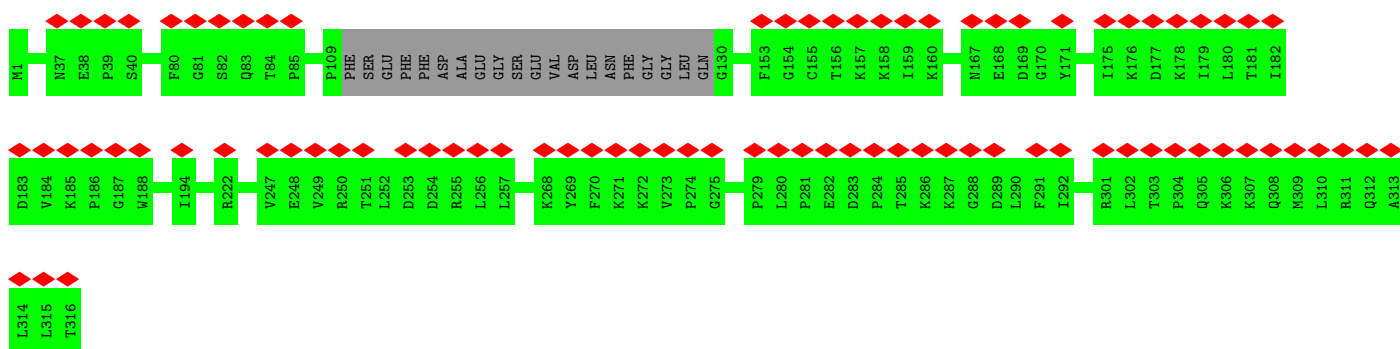

• Molecule 51: DnaJ homolog subfamily B member 13

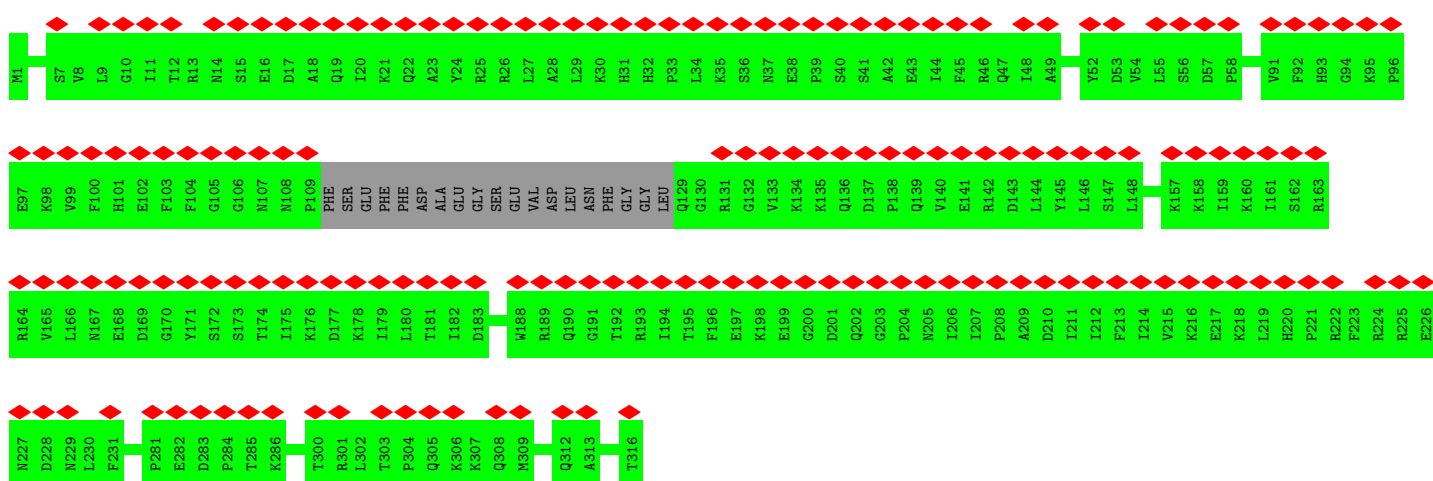

• Molecule 51: DnaJ homolog subfamily B member 13

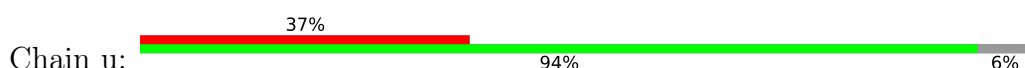

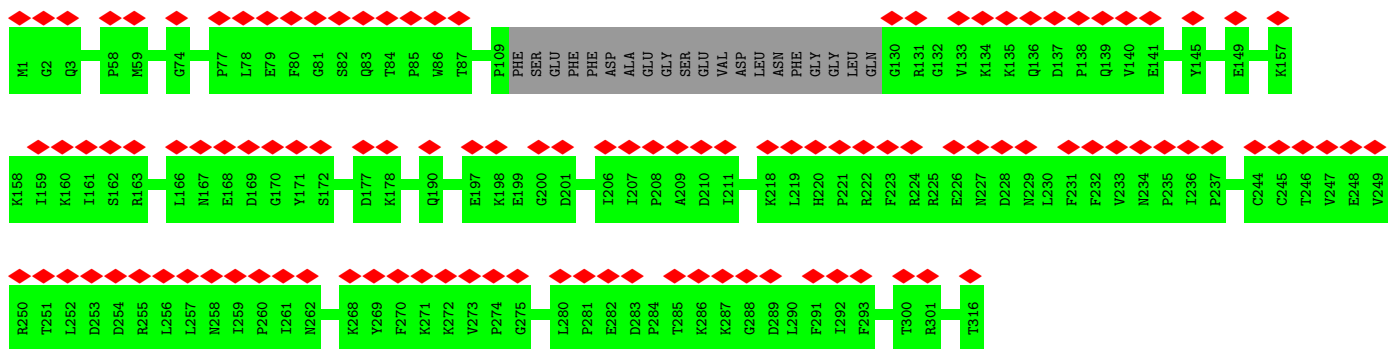

• Molecule 51: DnaJ homolog subfamily B member 13

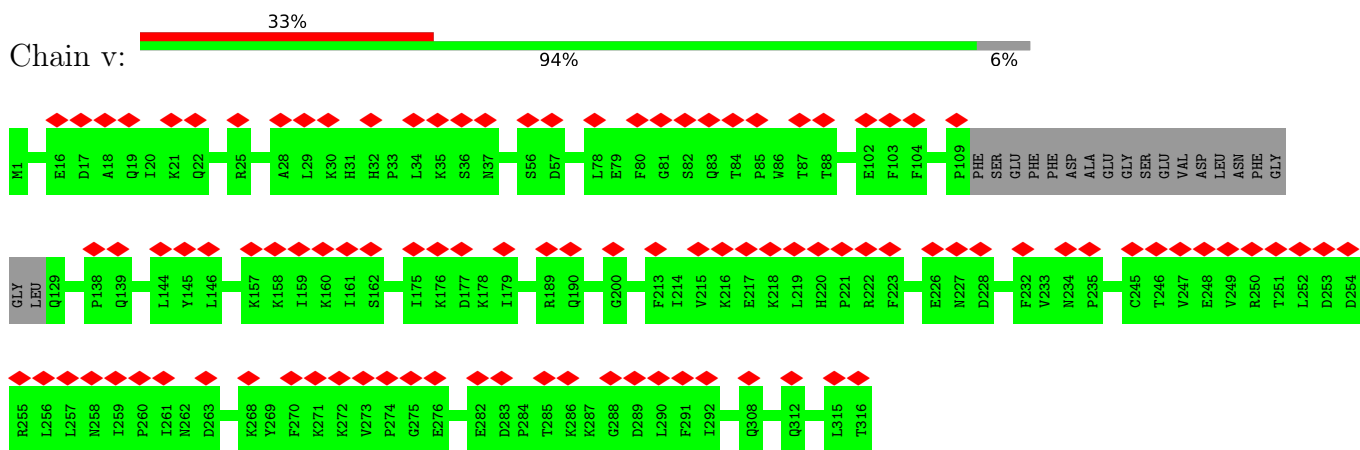

• Molecule 52: Calmodulin-1

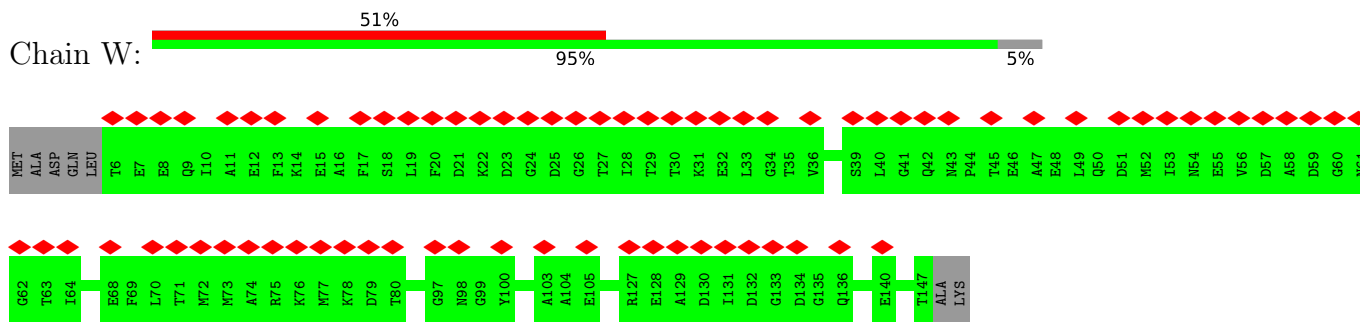

• Molecule 53: Nucleoside diphosphate kinase homolog 5



• Molecule 53: Nucleoside diphosphate kinase homolog 5

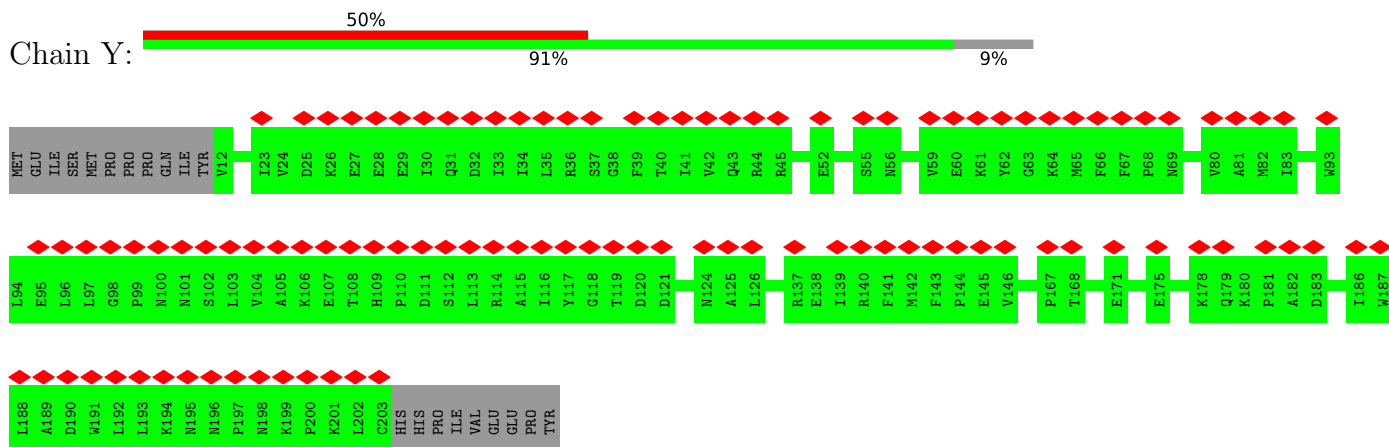

• Molecule 53: Nucleoside diphosphate kinase homolog 5

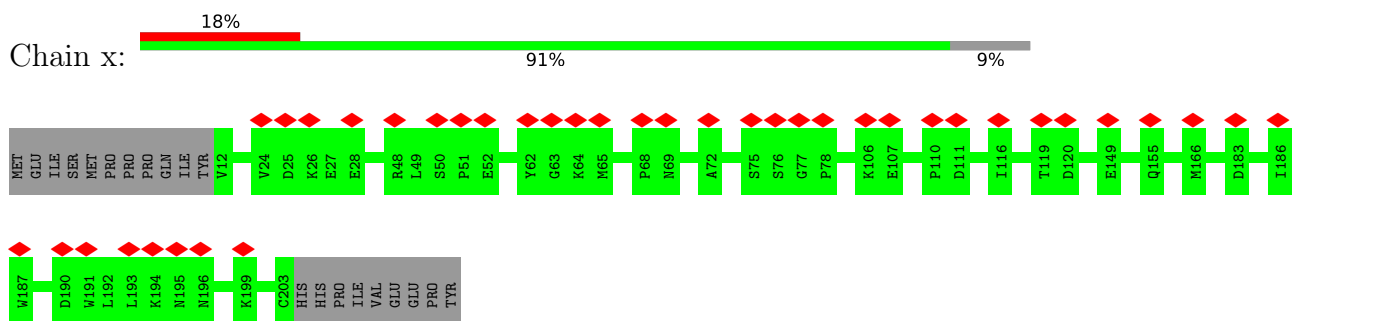

• Molecule 53: Nucleoside diphosphate kinase homolog 5

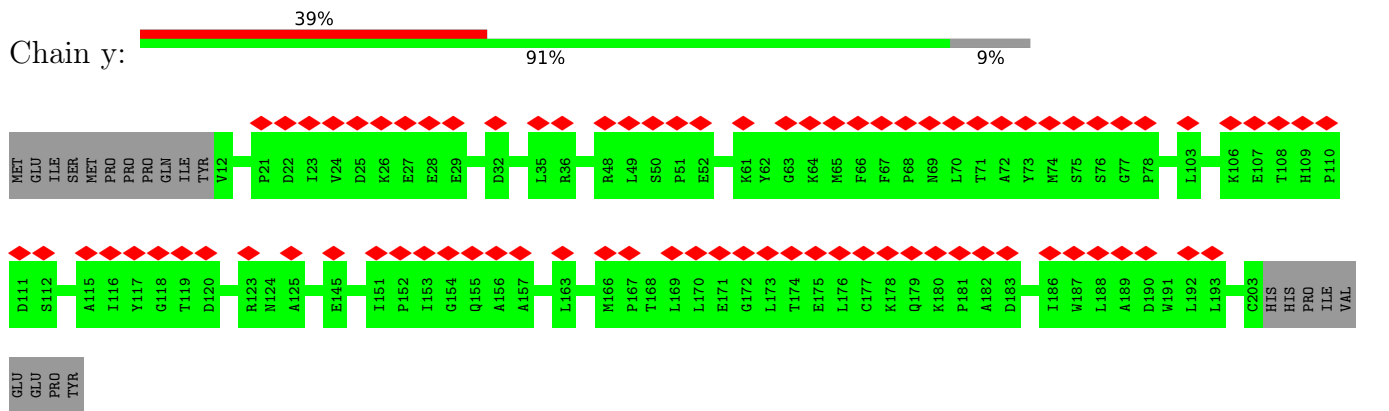

• Molecule 54: Cilia- and flagella-associated protein 20

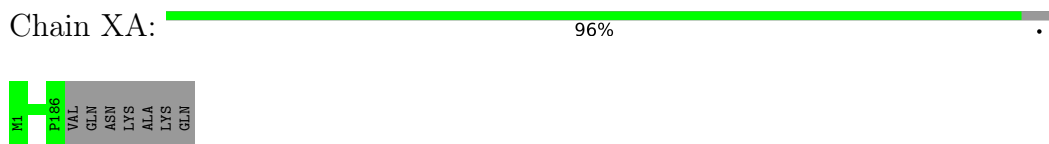

• Molecule 54: Cilia- and flagella-associated protein 20



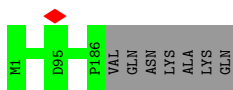

- Molecule 54: Cilia- and flagella-associated protein 20

Chain XC: 96%

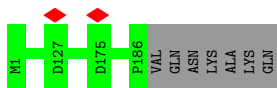

- Molecule 54: Cilia- and flagella-associated protein 20

Chain XD: 96%

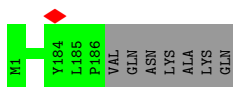

- Molecule 54: Cilia- and flagella-associated protein 20

Chain XE: 96%

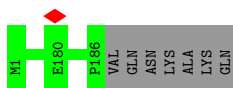

- Molecule 54: Cilia- and flagella-associated protein 20

Chain XF: 96%

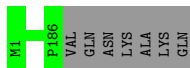

- Molecule 54: Cilia- and flagella-associated protein 20

Chain XG: 96%

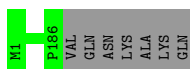

- Molecule 54: Cilia- and flagella-associated protein 20

Chain XH: 96%



- Molecule 54: Cilia- and flagella-associated protein 20



- Molecule 54: Cilia- and flagella-associated protein 20



- Molecule 54: Cilia- and flagella-associated protein 20

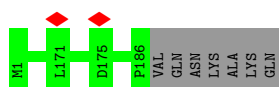

- Molecule 54: Cilia- and flagella-associated protein 20

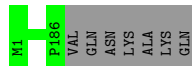

- Molecule 54: Cilia- and flagella-associated protein 20

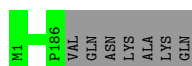

- Molecule 55: Parkin coregulated gene protein

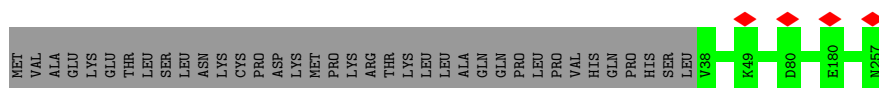

- Molecule 55: Parkin coregulated gene protein

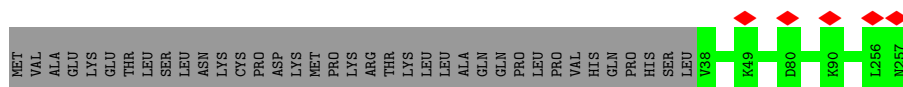
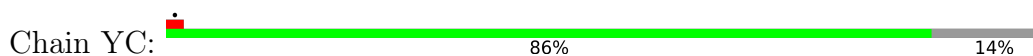

• Molecule 55: Parkin coregulated gene protein

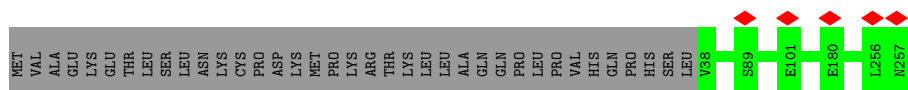
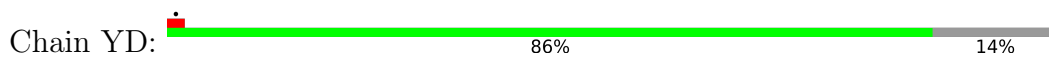

• Molecule 55: Parkin coregulated gene protein

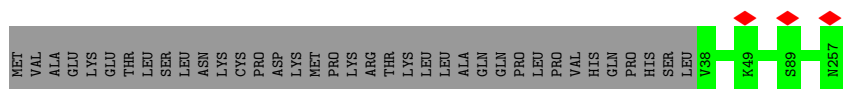
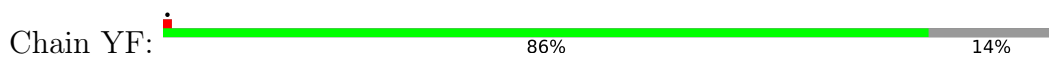

• Molecule 55: Parkin coregulated gene protein

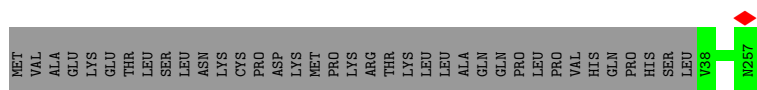
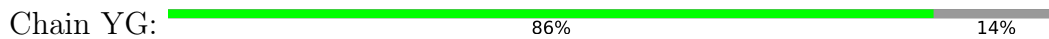

• Molecule 55: Parkin coregulated gene protein

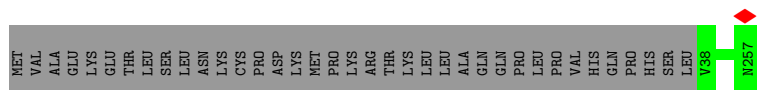
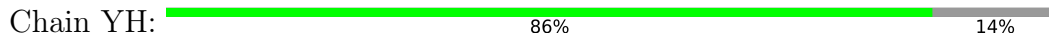

• Molecule 55: Parkin coregulated gene protein

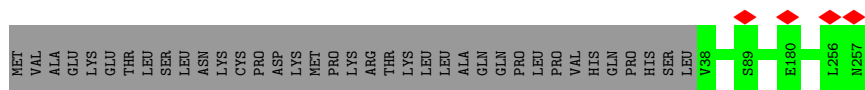
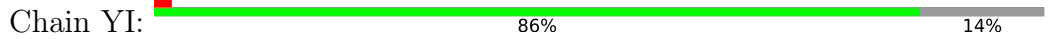

• Molecule 55: Parkin coregulated gene protein

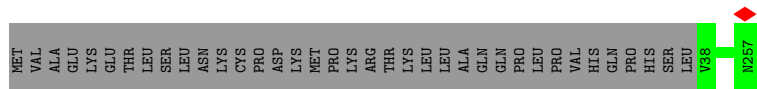
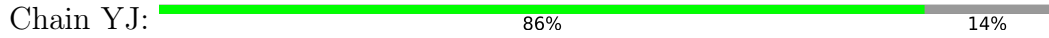

• Molecule 55: Parkin coregulated gene protein

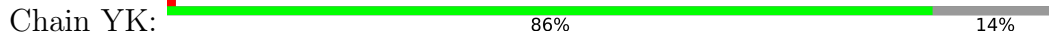

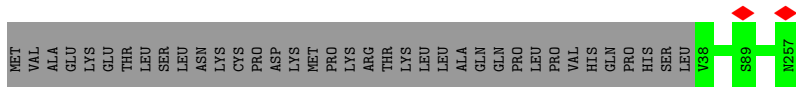

• Molecule 55: Parkin coregulated gene protein

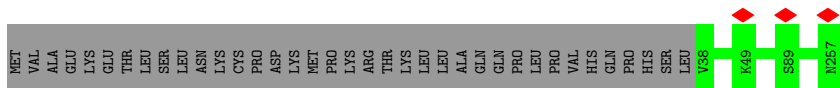
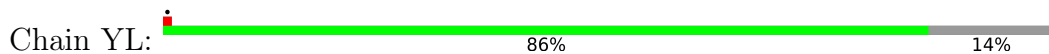

• Molecule 55: Parkin coregulated gene protein

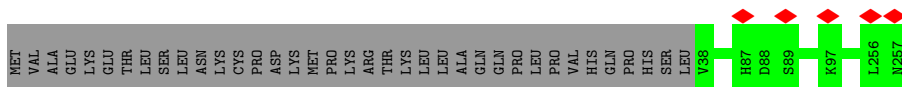

• Molecule 56: Cytochrome b5 domain-containing protein 1

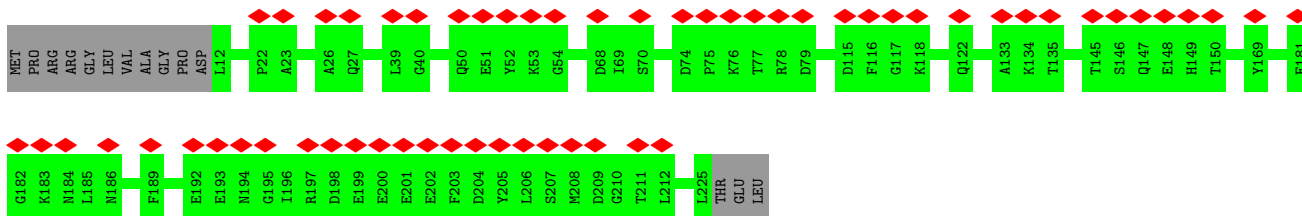
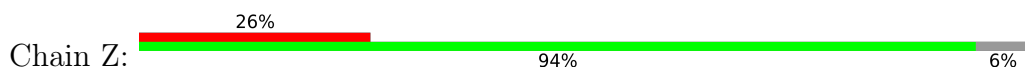

• Molecule 56: Cytochrome b5 domain-containing protein 1

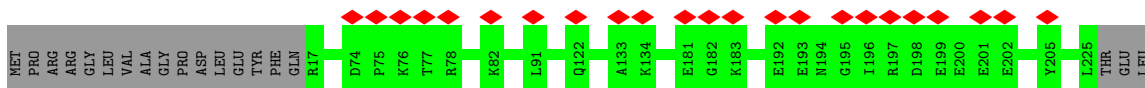
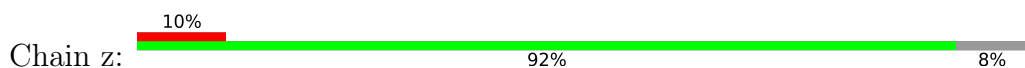

• Molecule 57: Unknown

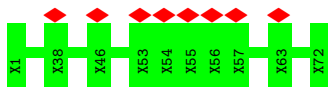

• Molecule 58: DYNLL1

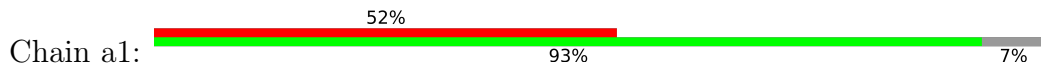

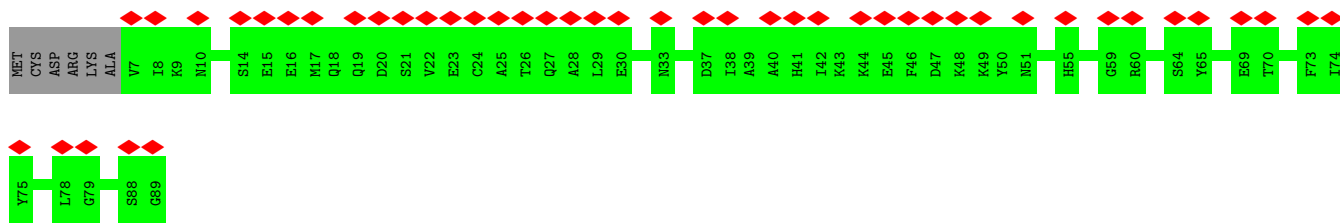

• Molecule 58: DYNLL1

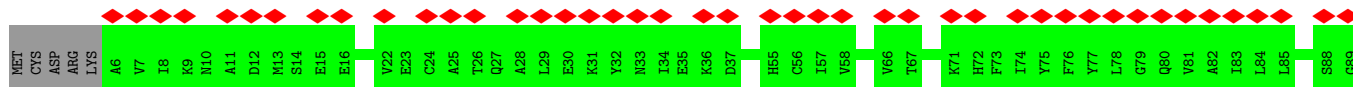

• Molecule 58: DYNLL1

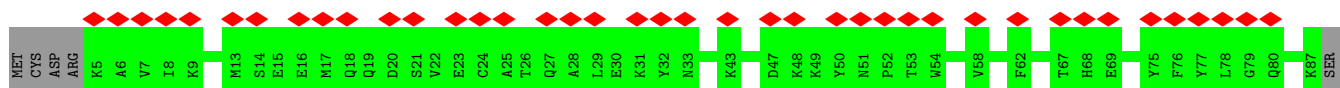

GLY

• Molecule 58: DYNLL1

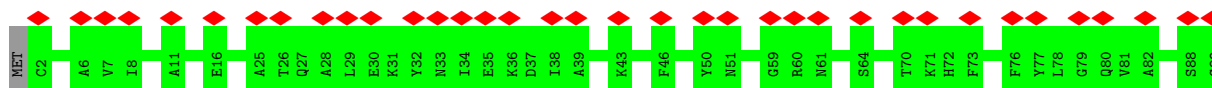

• Molecule 58: DYNLL1

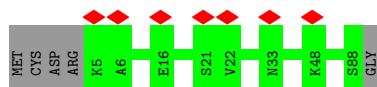

• Molecule 58: DYNLL1

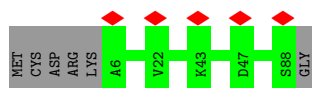

• Molecule 58: DYNLL1





• Molecule 58: DYNLL1

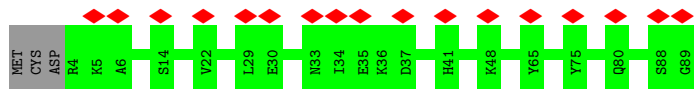

• Molecule 58: DYNLL1

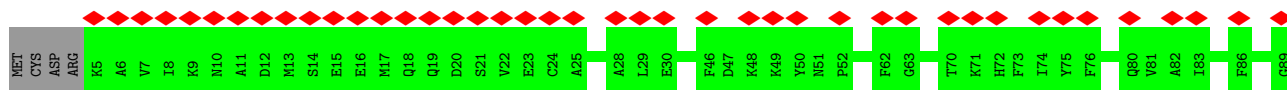

• Molecule 58: DYNLL1

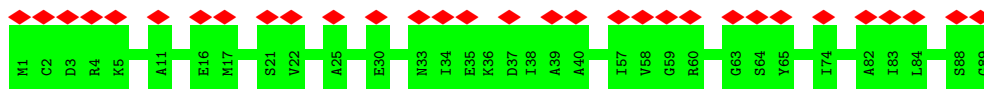

• Molecule 58: DYNLL1

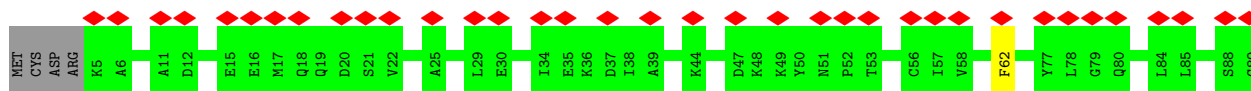
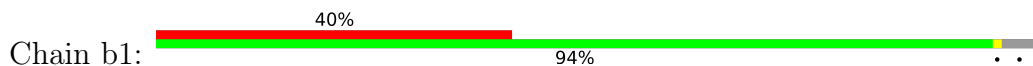

• Molecule 58: DYNLL1

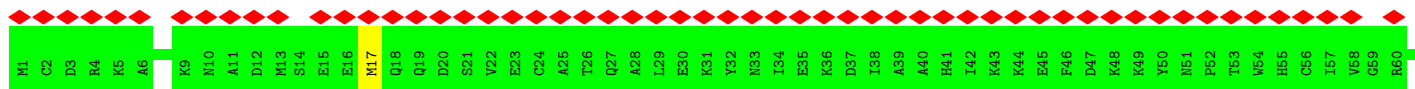
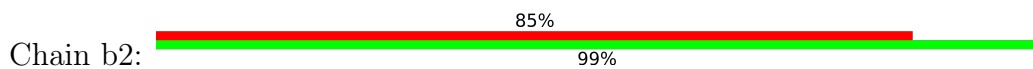

• Molecule 58: DYNLL1

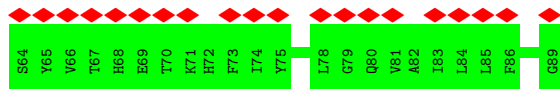

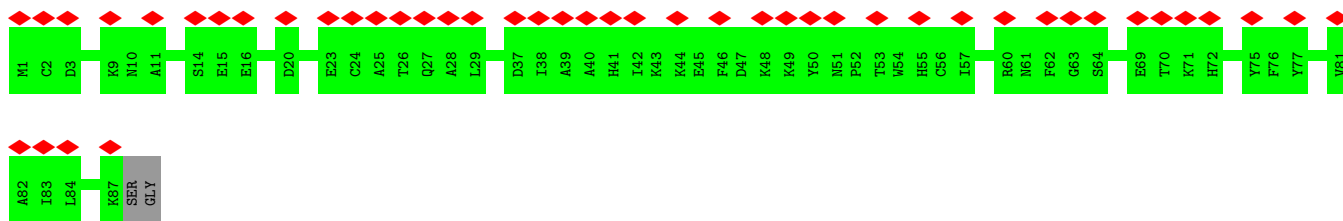

• Molecule 58: DYNLL1

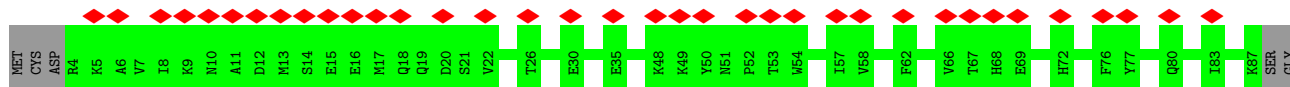
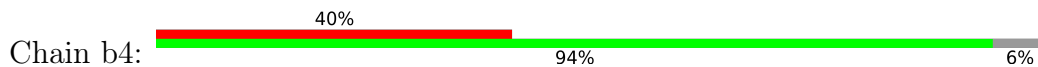

• Molecule 58: DYNLL1

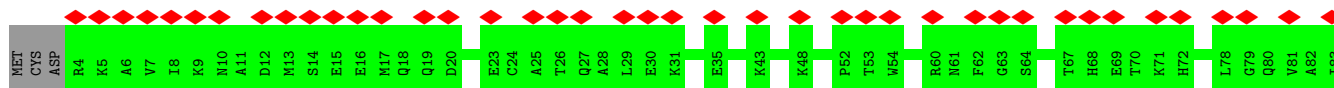

• Molecule 58: DYNLL1

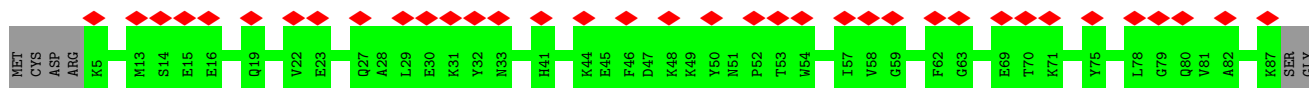
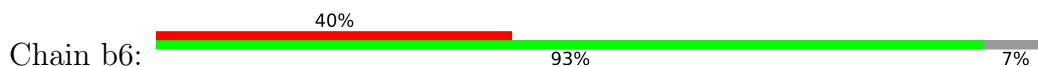

• Molecule 58: DYNLL1



• Molecule 58: DYNLL1

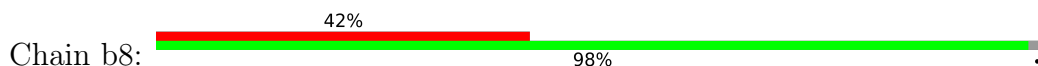

• Molecule 58: DYNLL1

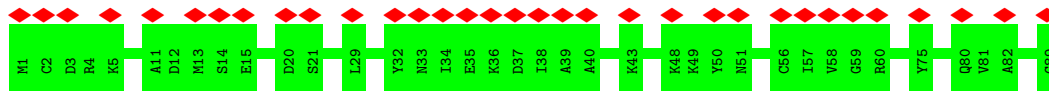

• Molecule 58: DYNLL1

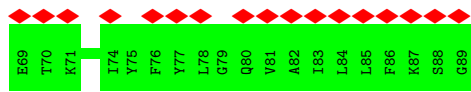
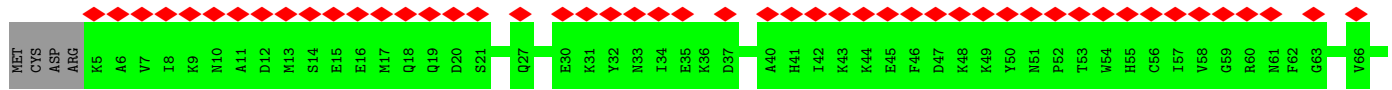
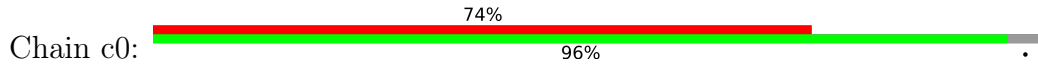

• Molecule 58: DYNLL1

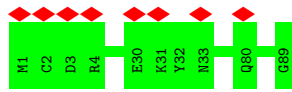

• Molecule 58: DYNLL1



• Molecule 58: DYNLL1



• Molecule 58: DYNLL1



• Molecule 58: DYNLL1



There are no outlier residues recorded for this chain.

- Molecule 58: DYNLL1

Chain l6:  100%



- Molecule 58: DYNLL1

Chain n1:  31%  100%

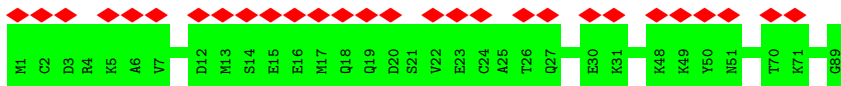

- Molecule 58: DYNLL1

Chain n2:  9%  100%

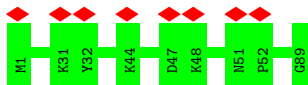

- Molecule 58: DYNLL1

Chain n3:  17%  100%

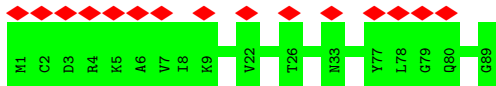

- Molecule 58: DYNLL1

Chain n4:  8%  100%

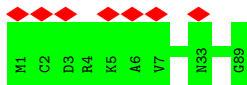

- Molecule 58: DYNLL1

Chain n5:  36%  100%



- Molecule 58: DYNLL1

Chain n6:  9%  100%

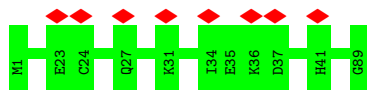

• Molecule 58: DYNLL1

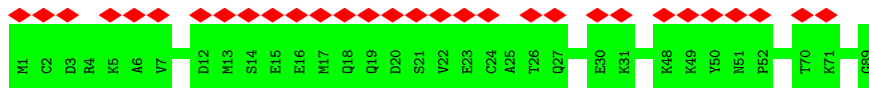

• Molecule 58: DYNLL1

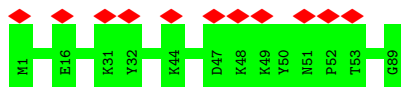

• Molecule 58: DYNLL1

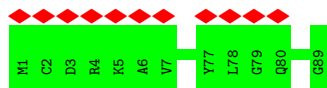

• Molecule 58: DYNLL1

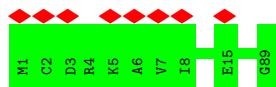

• Molecule 58: DYNLL1

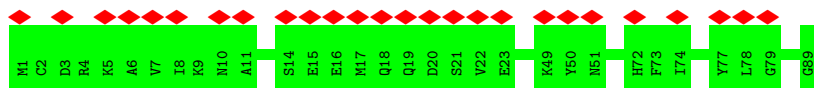

• Molecule 58: DYNLL1

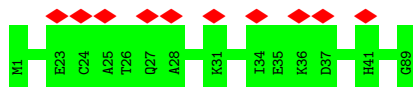

• Molecule 58: DYNLL1

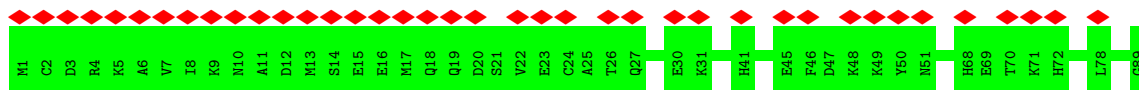
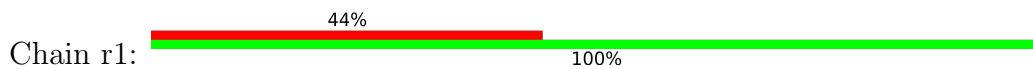

• Molecule 58: DYNLL1

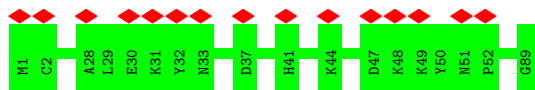

• Molecule 58: DYNLL1

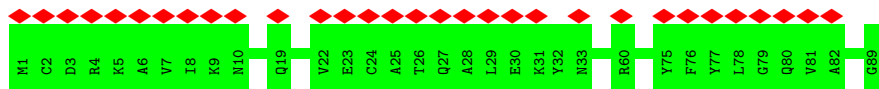

• Molecule 58: DYNLL1

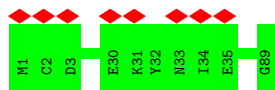

• Molecule 58: DYNLL1

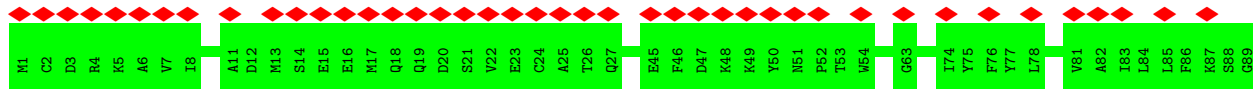

• Molecule 58: DYNLL1

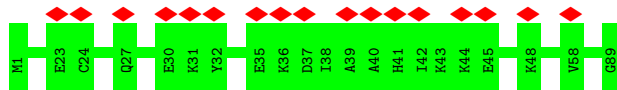

• Molecule 59: MORN repeat-containing protein 3

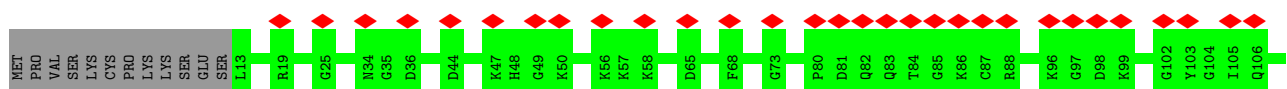

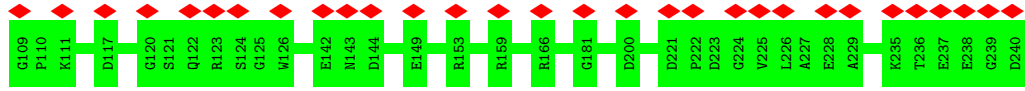

• Molecule 60: IQ and ubiquitin-like domain-containing protein

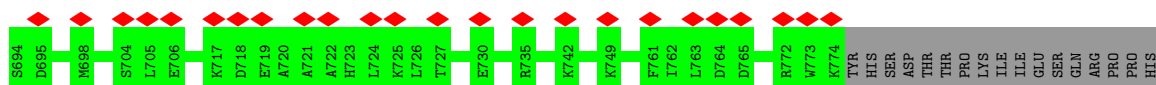
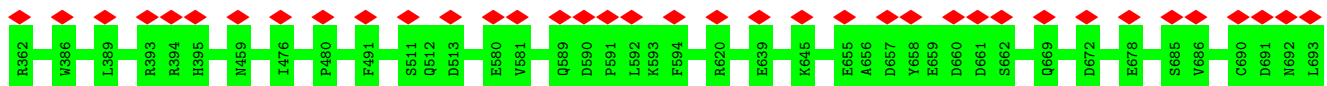
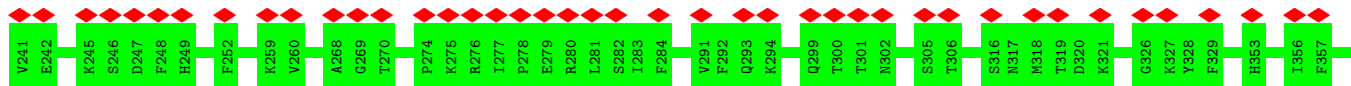
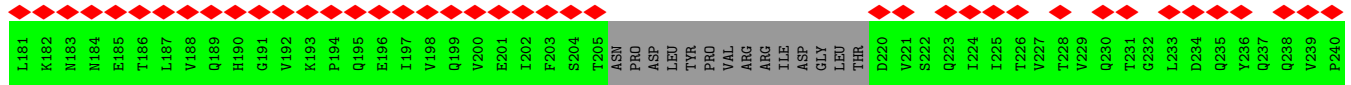
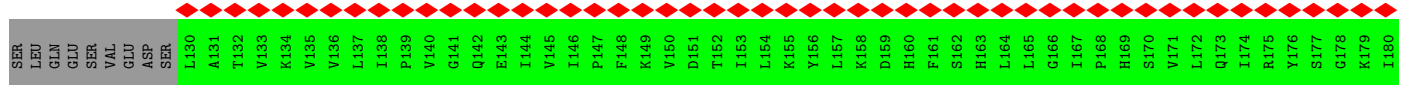
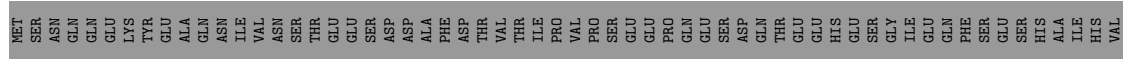
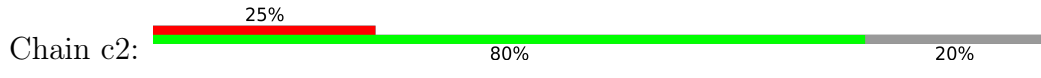

• Molecule 61: DPY30 domain-containing protein 2

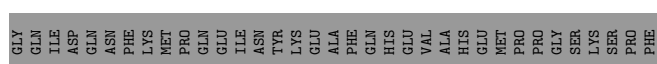
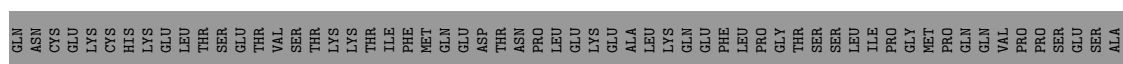
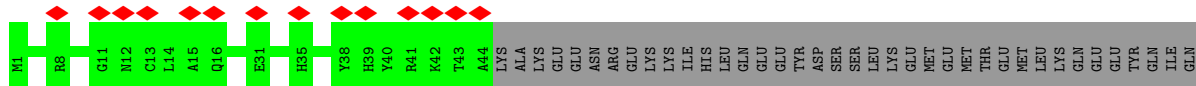

• Molecule 61: DPY30 domain-containing protein 2

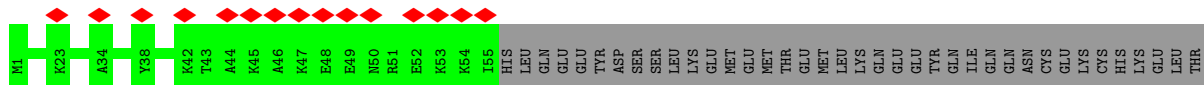

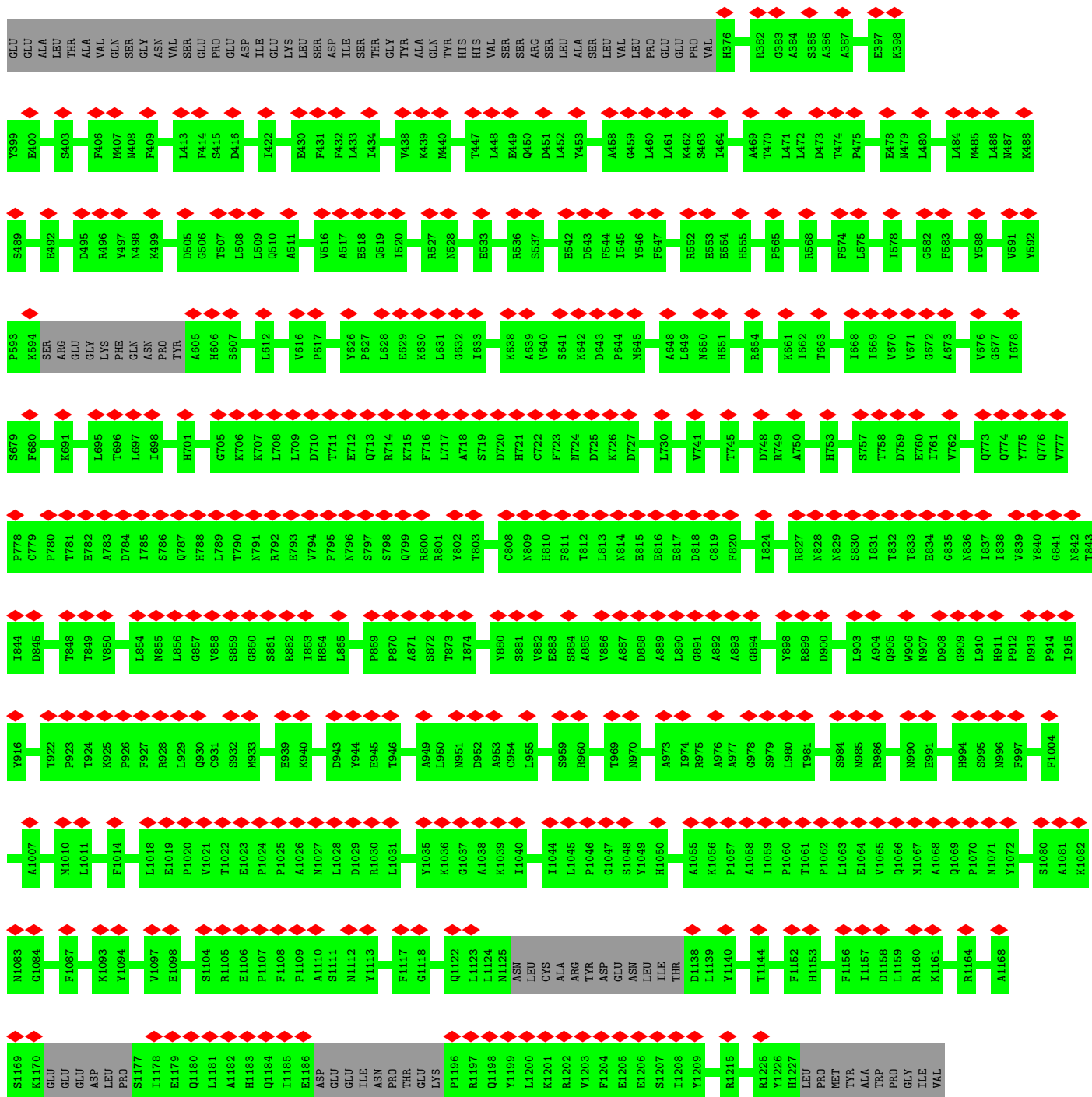

• Molecule 63: Cilia- and flagella-associated protein 91

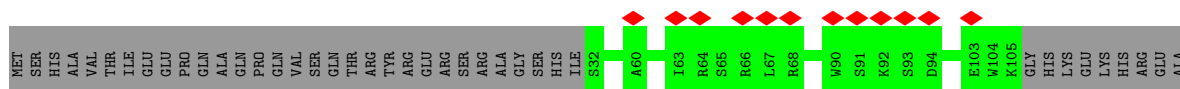

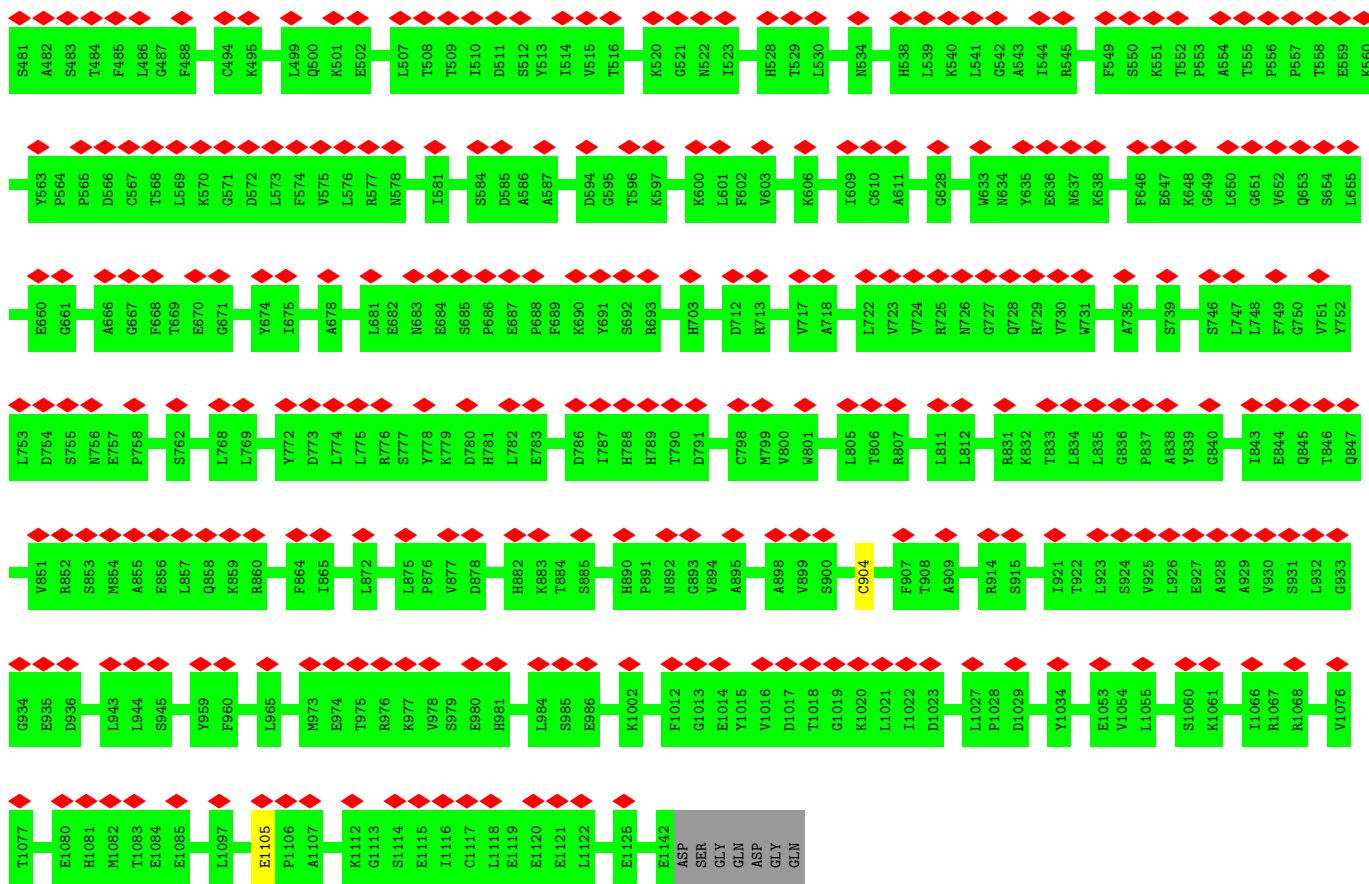

• Molecule 65: Tetratricopeptide repeat protein 29

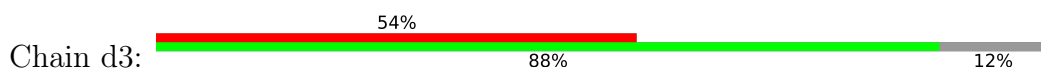

Chain d3:

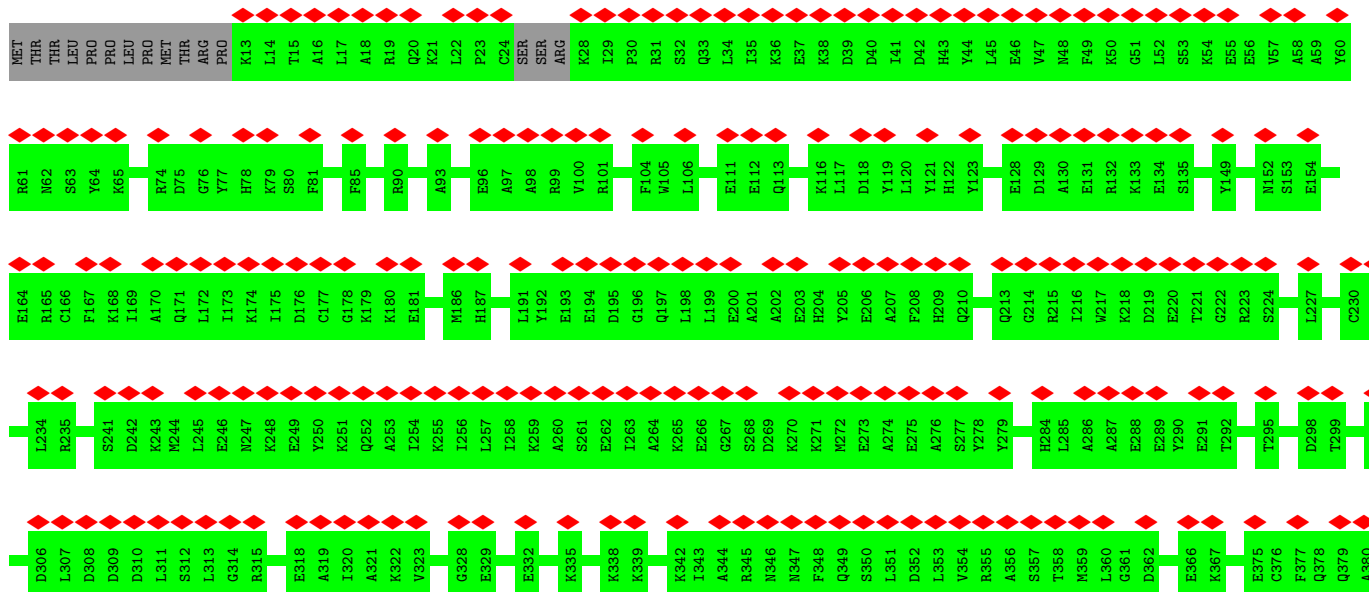

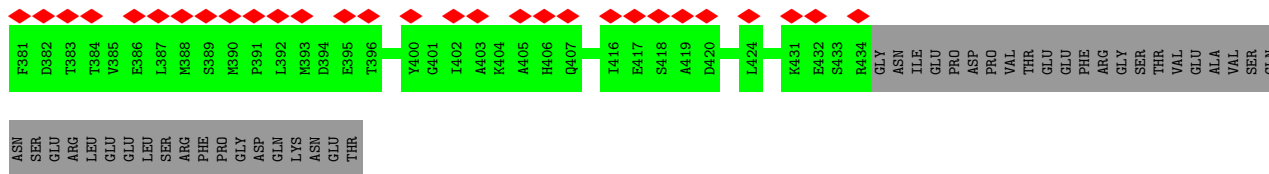

• Molecule 66: Zinc finger MYND domain-containing protein 12



• Molecule 67: ACTA2

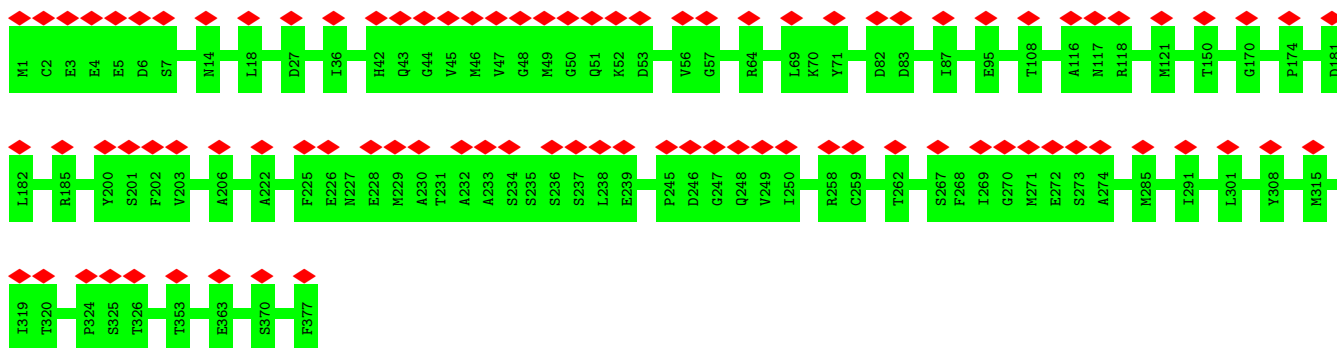

• Molecule 67: ACTA2

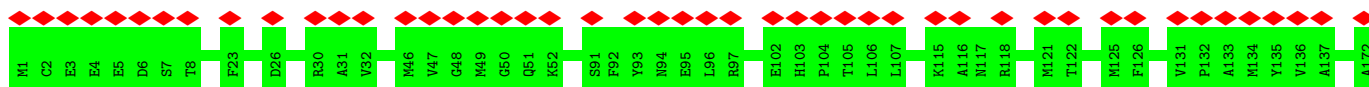

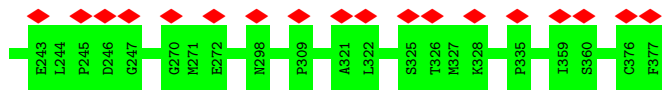

• Molecule 67: ACTA2

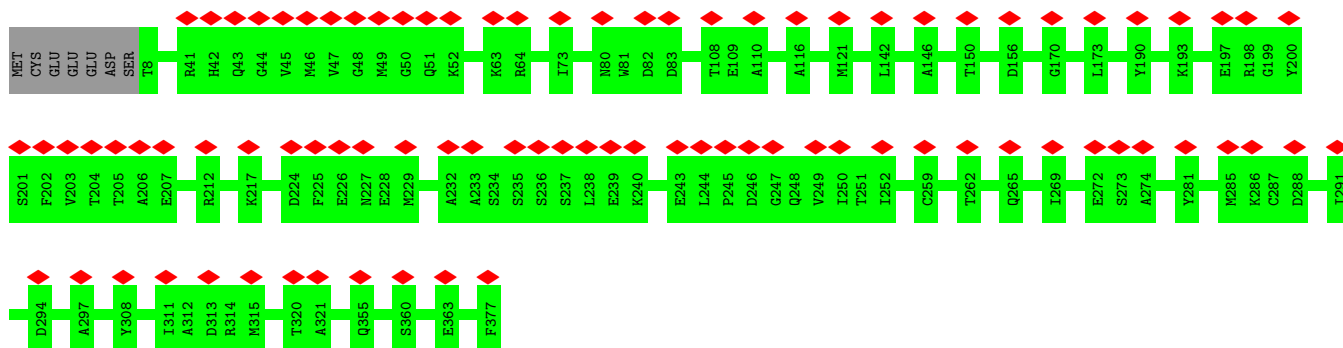

• Molecule 67: ACTA2

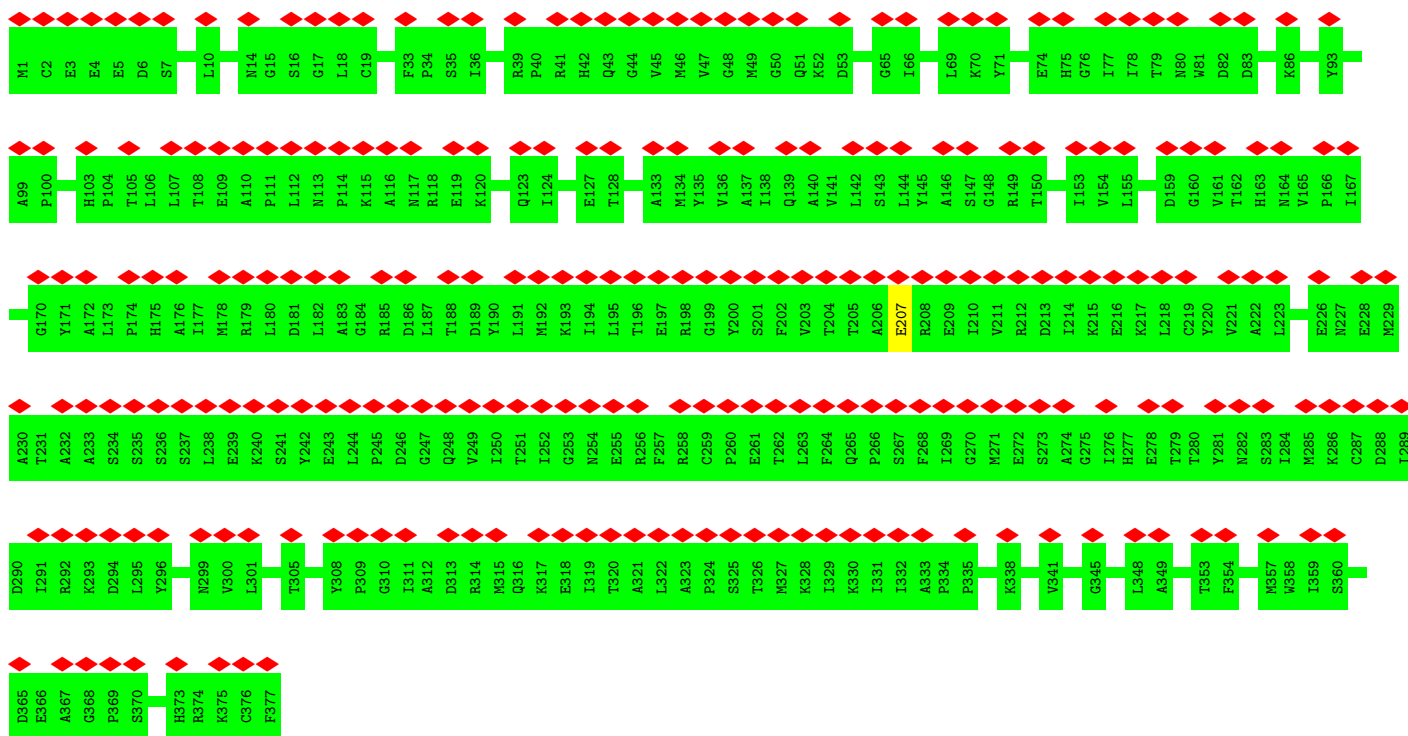

• Molecule 67: ACTA2

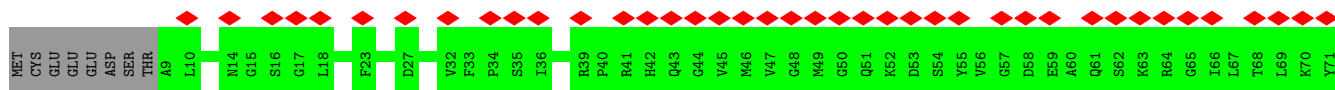

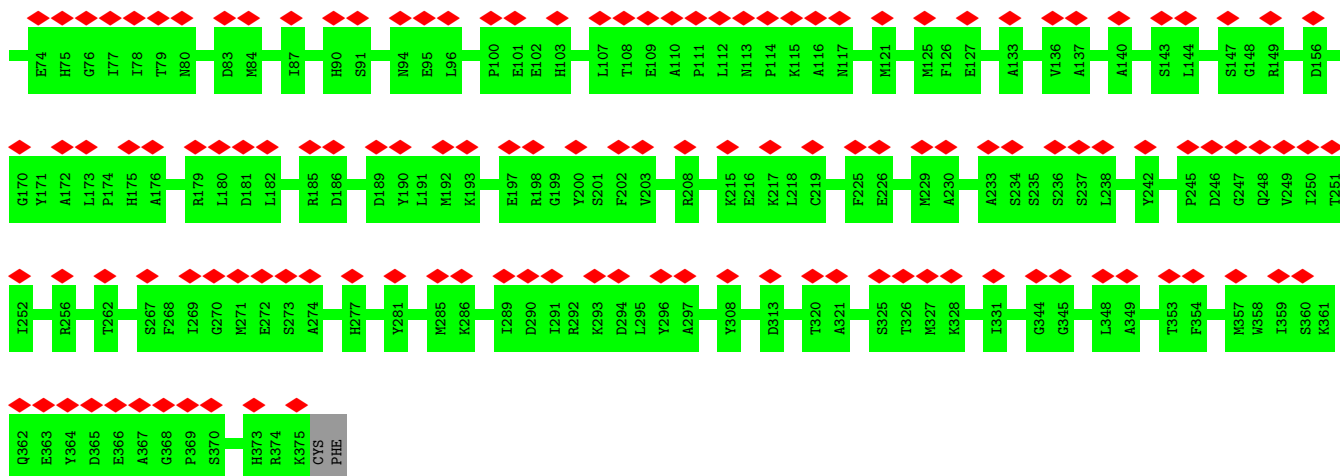

• Molecule 67: ACTA2

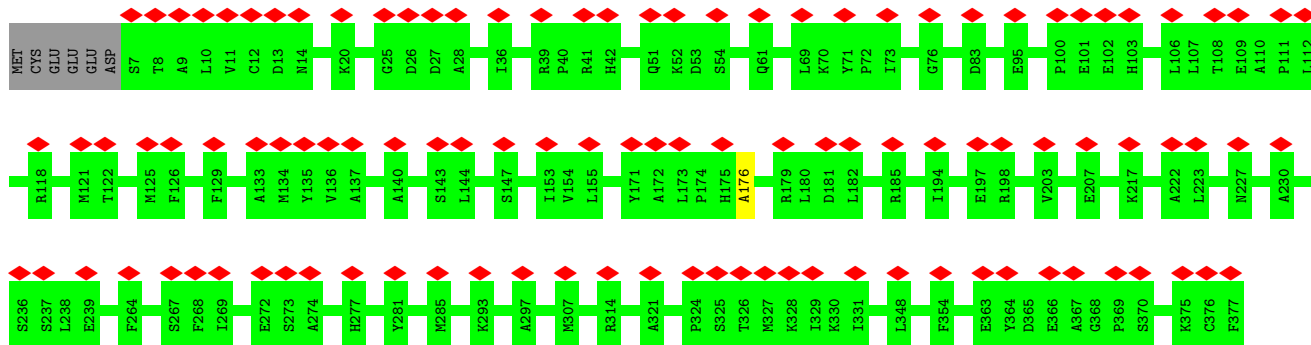

• Molecule 68: Axonemal dynein light intermediate polypeptide 1

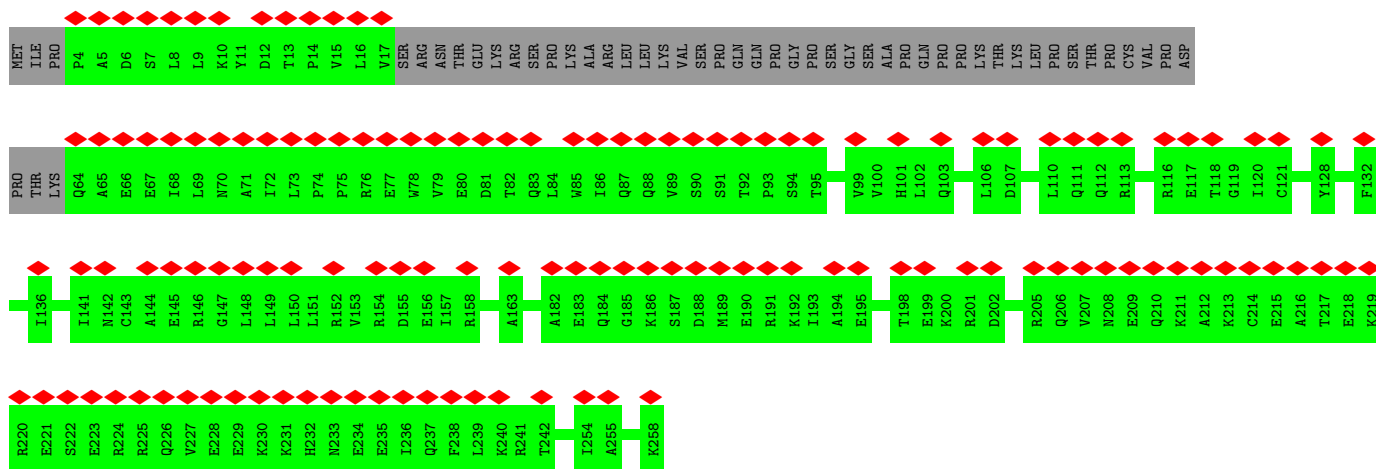
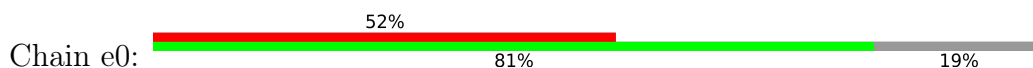

• Molecule 68: Axonemal dynein light intermediate polypeptide 1

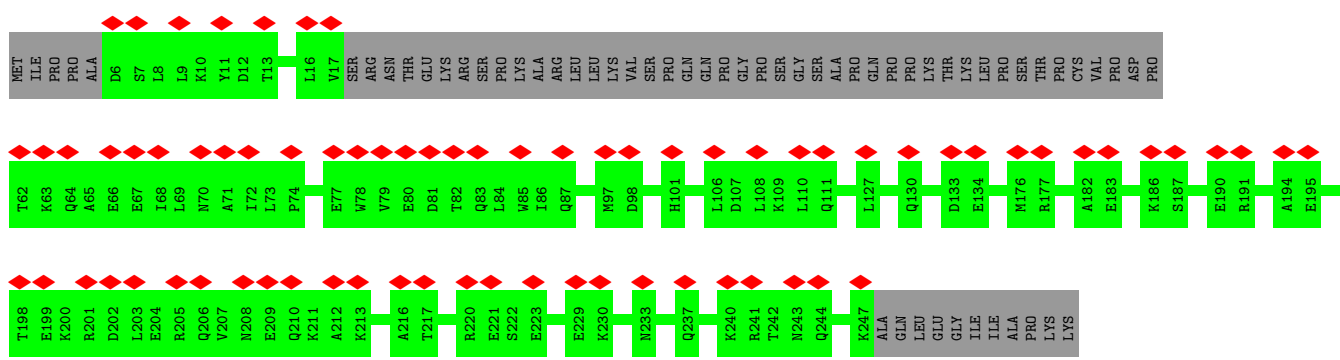
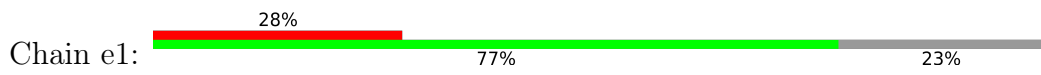

• Molecule 68: Axonemal dynein light intermediate polypeptide 1

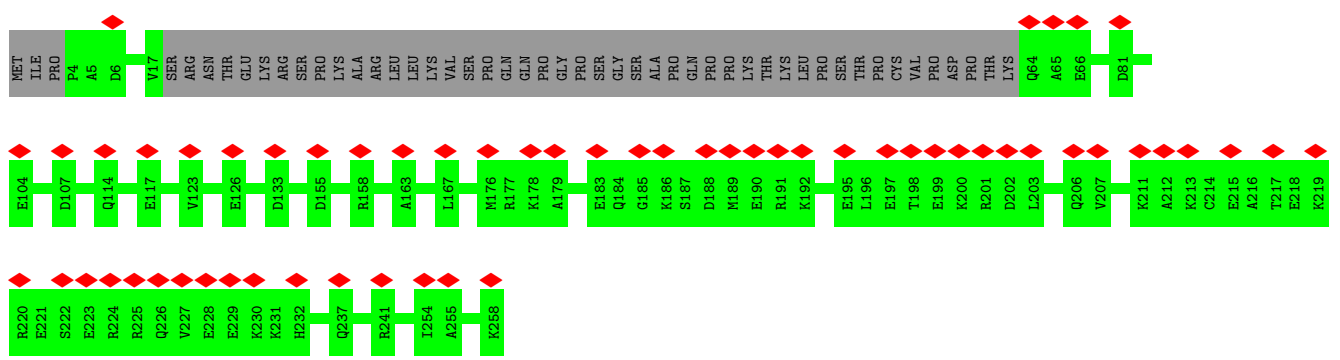
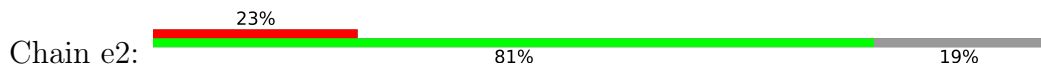

• Molecule 68: Axonemal dynein light intermediate polypeptide 1

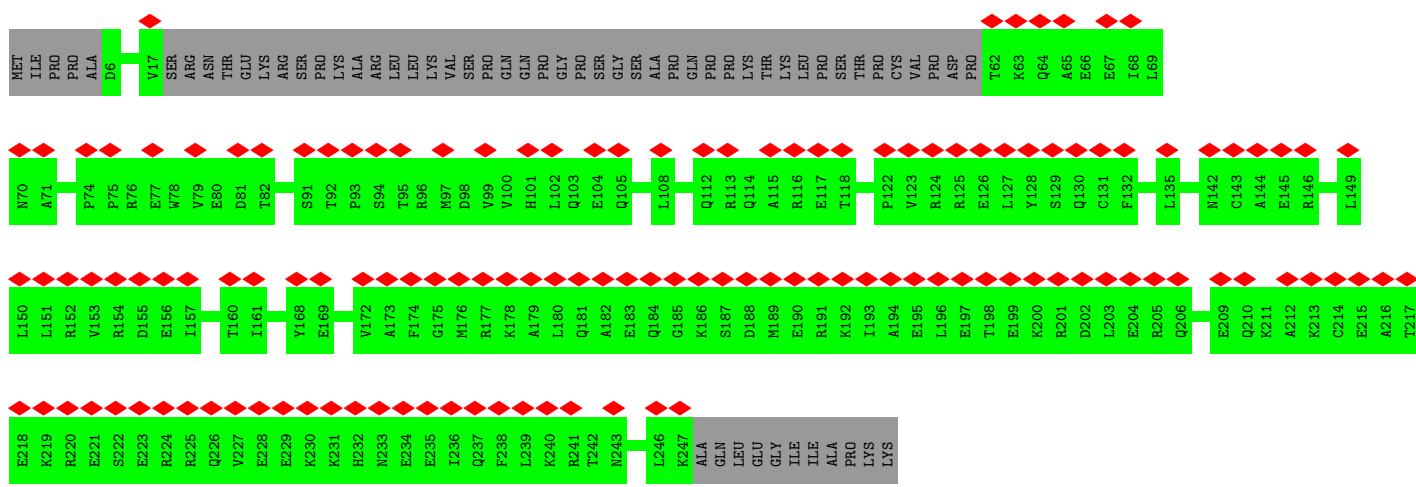
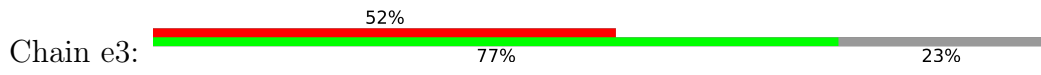

• Molecule 68: Axonemal dynein light intermediate polypeptide 1

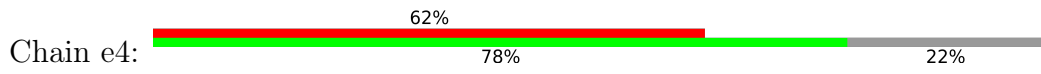

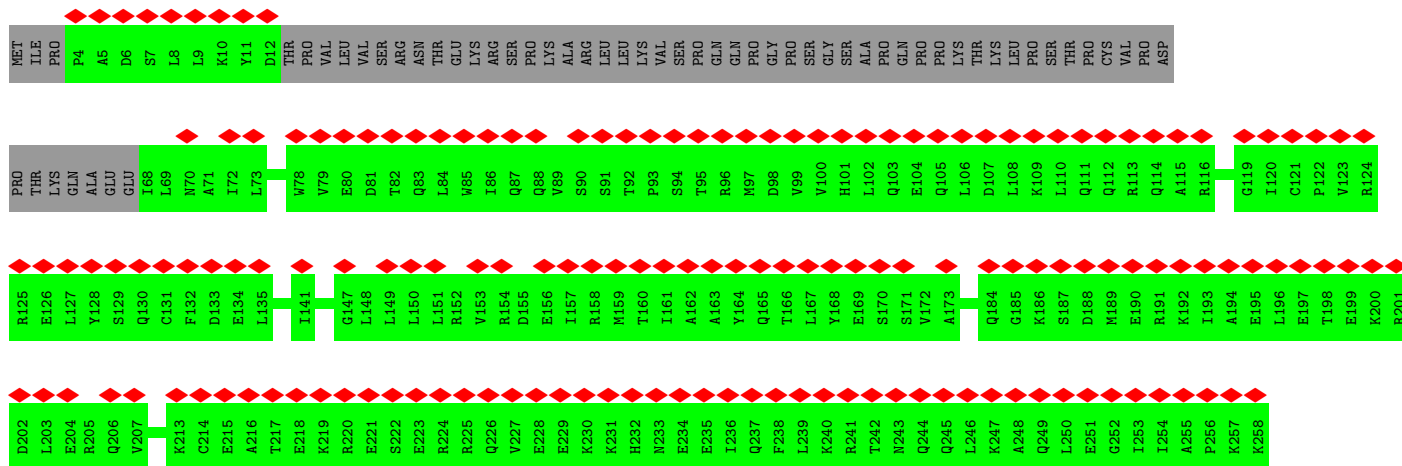

• Molecule 68: Axonemal dynein light intermediate polypeptide 1

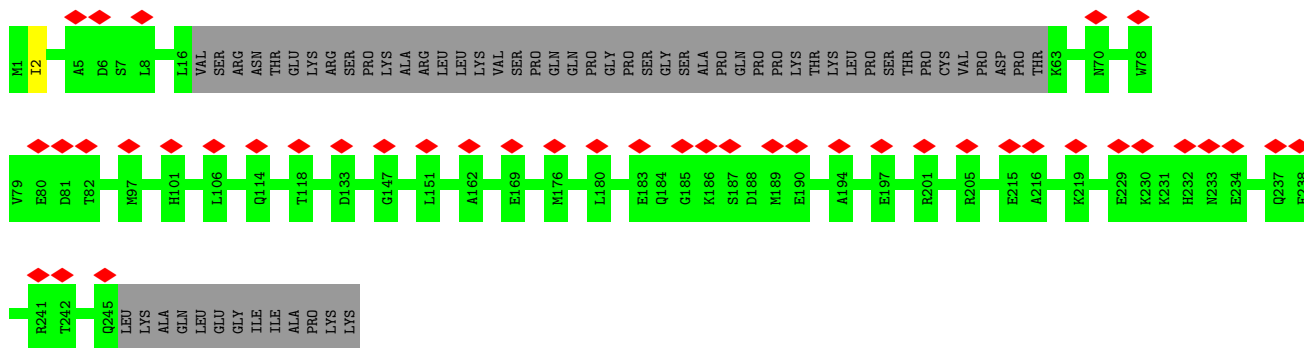
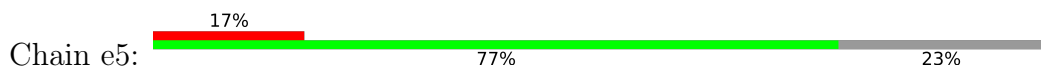

• Molecule 68: Axonemal dynein light intermediate polypeptide 1

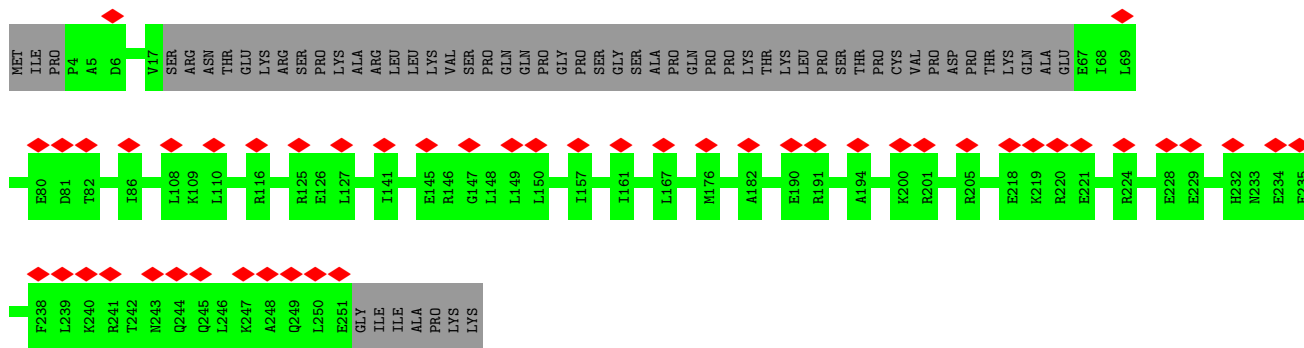
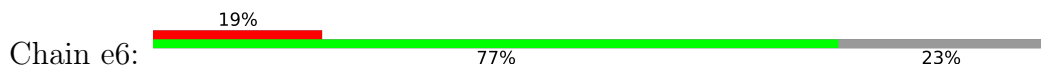

• Molecule 68: Axonemal dynein light intermediate polypeptide 1

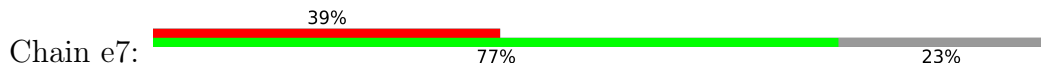

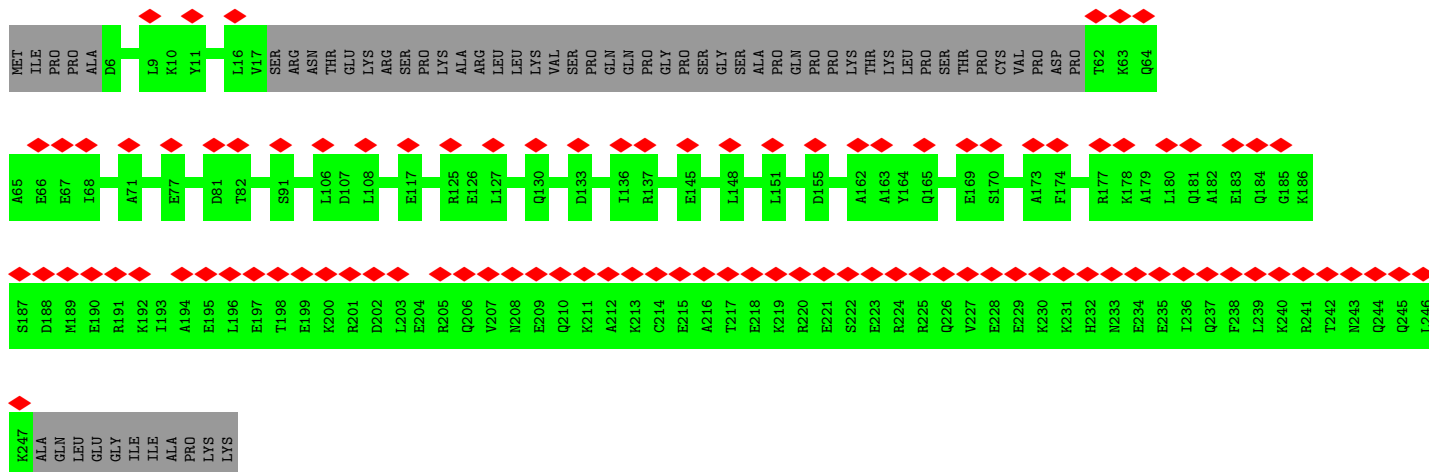

• Molecule 68: Axonemal dynein light intermediate polypeptide 1

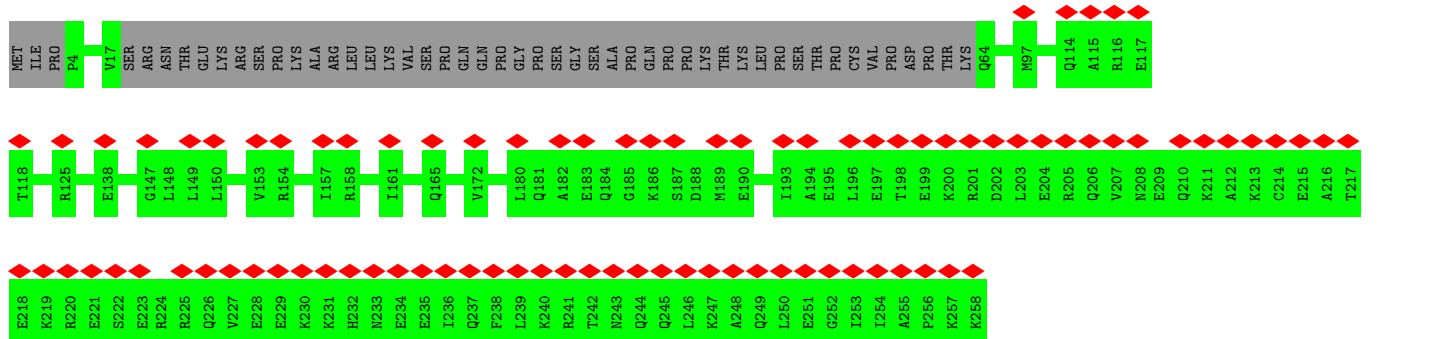
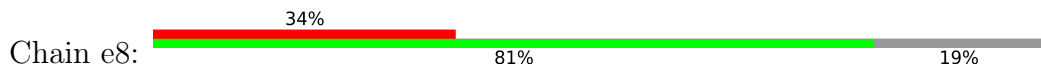

• Molecule 68: Axonemal dynein light intermediate polypeptide 1

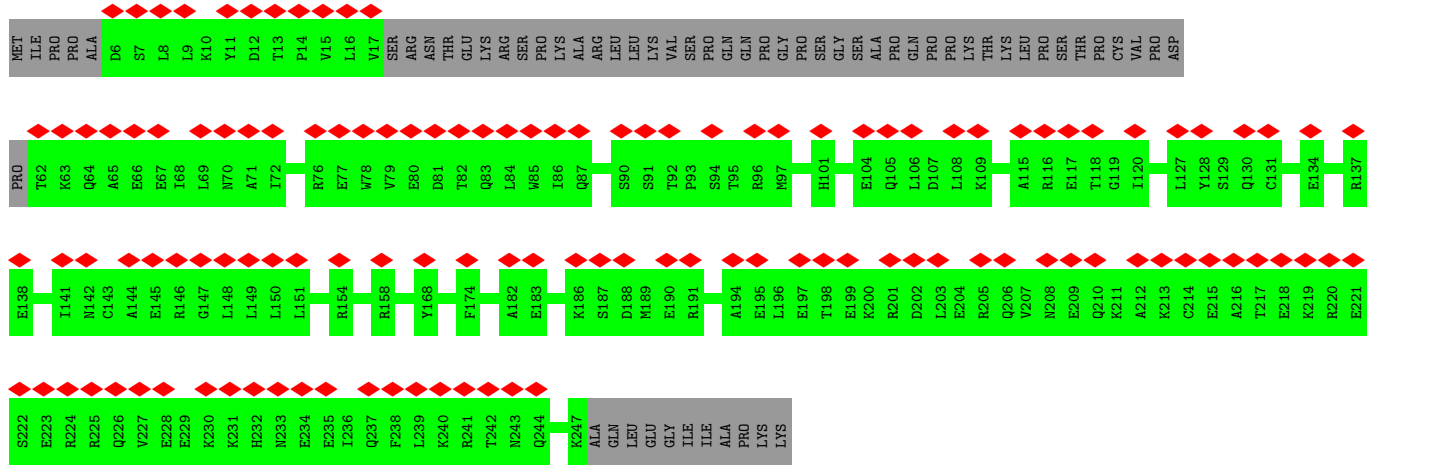
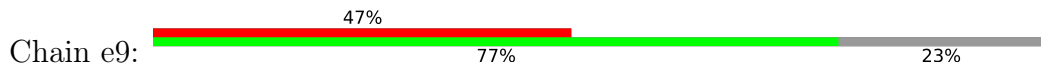

• Molecule 69: Centrin-2

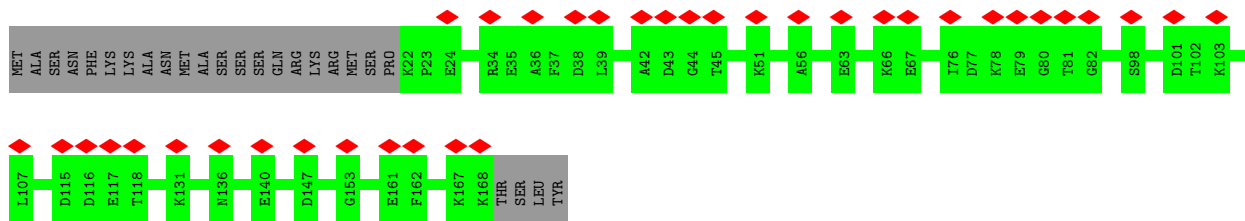
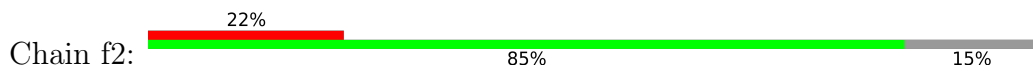

• Molecule 70: Dynein axonemal heavy chain 12

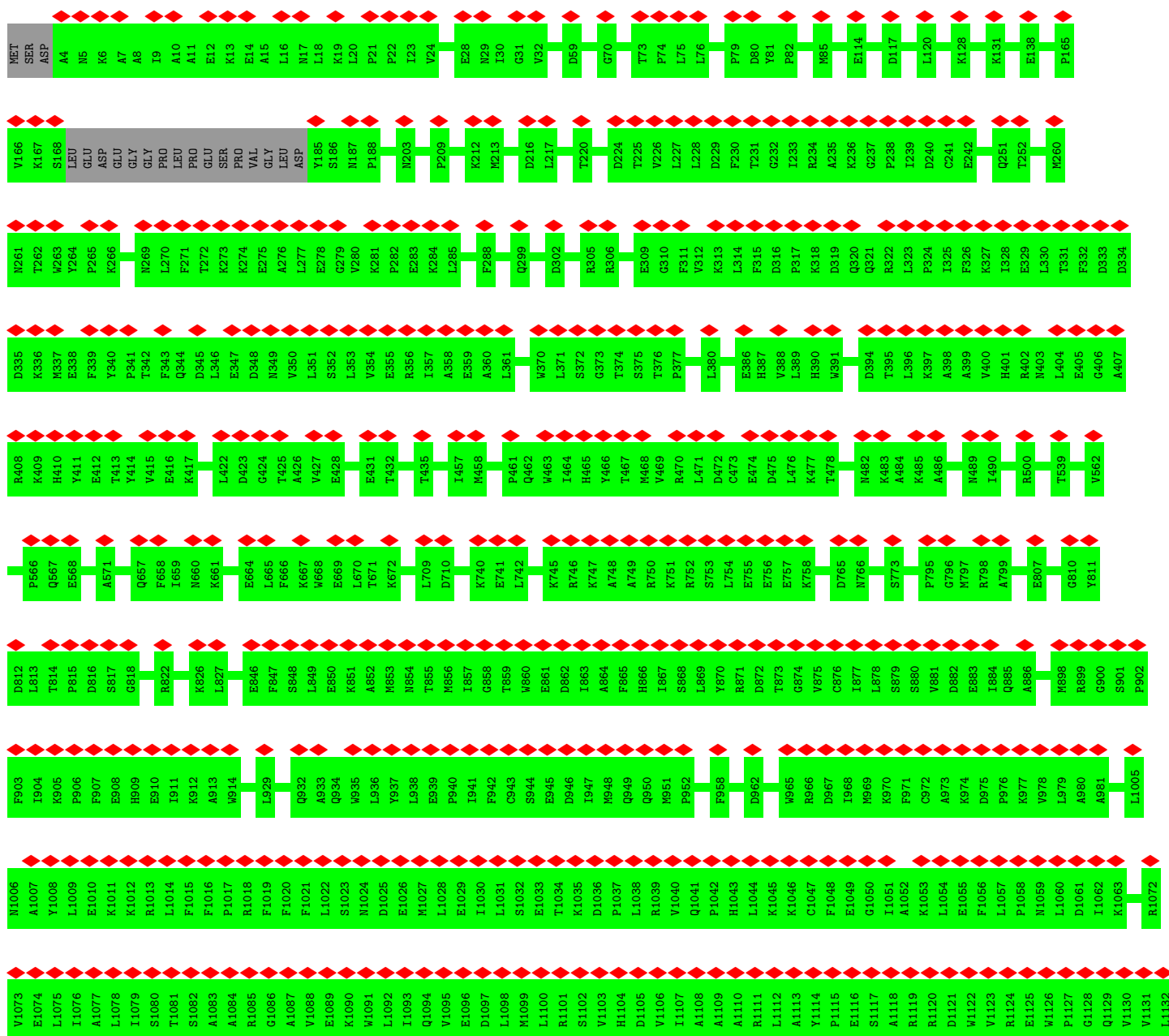

C1133	I1134	S1135	Q1136	M1137	F1138	M1139	T1140	S1141	E1142	T1143	Q1144	V1145	I1146	I1147	S1148	G1149	G1150	T1151	E1152	G1153	L1154	K1155	K1156	Y1157	Y1158	K1159	E1160	L1161	M1162	M1163	Q1164	L1165	L1166	E1167	I1168	V1169	E1170	L1171	V1172	R1173	G1174	K1175	L1176	T1180	L1184	L1187	V1188	T1189	I1190	D1191	V1192	H1193	A1194	R1195	D1196	V1197			
V1198	M1199	D1200	M1201	I1202	K1203	M1204	G1205	V1206	S1207	H1208	D1209	T1210	D1211	F1212	L1213	W1214	L1215	A1216	Q1217	L1218	R1219	Y1220	W1221	W1222	E1223	N1224	E1225	A1227	R1228	Y1229	R1230	N1233	E1234	N1235	V1236	K1237	Y1238	A1239	Y1240	E1241	Y1242	A1278	T1283	E1284	V1285	T1286	K1287	A1290	K1291	V1295	Q1296	C1297	V1298						
V1299	F1300	M1301	C1302	S1303	N1304	G1305	L1306	D1307	Y1308	L1309	A1310	M1311	G1312	K1313	F1314	F1315	K1316	G1317	L1318	A1319	S1320	S1321	G1322	W1323	A1324	A1325	C1326	F1327	L1328	E1329	F1330	M1331	R1332	I1333	E1334	L1335	L1336	V1337	L1338	S1339	V1340	V1341	Q1344	V1358	F1359	V1360	F1361	E1362	T1364	E1365	L1366	F1373	V1374	A1375	I1376				
T1377	M1378	M1379	F1380	G1381	Y1382	A1383	G1384	R1385	S1386	E1387	L1388	P1389	G1418	F1419	L1420	N1421	A1422	R1423	L1465	K1466	Y1467	P1468	L1469	E1470	N1471	A1472	D1473	I1474	L1475	P1494	M1497	G1498	S1501	D1502	L1503	F1504	F1505	G1506	I1507	K1508	L1509	P1510	E1511	A1512	D1513	Y1514	H1515	E1516	H1522	E1523	A1524	C1525	N1526						
V1527	F1532	D1572	T1575	L1576	M1577	N1578	E1579	H1580	G1581	Y1582	G1583	E1584	K1587	V1588	I1589	F1607	D1608	P1609	V1610	P1660	H1612	E1613	E1625	L1628	S1629	T1630	T1631	P1632	D1633	R1634	K1635	G1666	Q1670	S1685	Q1686	W1714	L1715	M1716	S1717	L1718	K1719	G1720	P1721	L1722	C1723	E1724	P1725	E1726											
Y1727	Q1728	A1729	L1730	L1731	R1732	G1733	L1734	F1735	A1736	W1737	L1738	I1739	P1740	P1741	S1742	N1743	M1744	Q1745	R1746	K1747	L1748	K1749	C1750	K1751	E1752	L1753	I1754	P1755	T1756	S1757	N1758	S1759	M1760	V1761	V1762	V1763	S1764	L1765	T1766	R1767	F1769	E1770	V1771	L1772	L1773	C1774	M1775	V1776	V1777	E1778	M1779	D1780	P1781	L1782	S1783	K1784	H1785	I1786	
R1787	V1788	W1789	I1790	M1791	A1792	C1793	F1794	I1795	F1796	S1797	L1798	I1799	W1800	S1801	I1802	G1803	G1804	S1805	C1806	D1807	T1808	D1809	G1810	R1811	R1812	V1813	F1814	D1815	R1816	F1817	I1818	R1819	L1820	I1821	I1822	L1823	G1824	K1825	D1826	R1827	E1828	M1829	P1830	V1831	P1832	D1833	S1834	V1835	G1836	K1837	W1838	E1839	C1840	P1841	F1842	D1843	E1844	K1845	G1846
L1847	V1848	Y1849	D1850	Y1851	M1852	Y1853	E1854	L1855	K1856	M1857	K1858	L1859	R1860	W1861	V1862	H1863	Q1877	I1878	K1879	L1896	L1899	S1900	I1901	T1902	Y1903	A1904	K1905	P1906	L1907	L1908	K1963	L1986	E1987	K1988	Y1989	G1990	P2030	F2036	V2037	T2038	P2039	R2040	C2041	I2042	F2045	N2046	L2047	C2048	S2049	S2054									
D2055	E2056	T2057	M2058	V2059	R2060	S2063	S2064	I2065	V2066	A2067	F2068	Y2069	L2070	R2071	T2072	H2073	E2074	F2075	P2076	P2077	E2078	Y2079	F2080	V2081	I2082	G2083	N2084	Q2085	V2086	I2087	N2088	G2089	T2090	M2091	E2092	I2093	T2094	K2095	Q2096	S2097	V2098	E2099	N2100	L2101	I2121	R2122	G2123	C2124	L2125	L2126	I2127	E2128	R2129	D2130	A2131	V2132	A2133		
N2134	K2135	H2136	T2137	M2138	I2139	R2140	L2141	F2142	V2143	H2144	E2145	L2146	L2147	R2148	Y2151	D2152	R2153	L2154	I2155	N2156	D2157	D2158	D2159	R2160	W2161	L2163	F2164	Q2165	T2166	T2167	K2168	T2169	V2170	I2171	K2172	D2173	H2174	F2175	K2176	E2177	S2178	F2179	H2180	S2181	T2182	F2183	S2184	H2185	L2186	R2187	K2188	Q2189	N2190	A2191	D2192	V2193	T2194		
E2195	E2196	D2197	L2198	R2199	N2200	L2201	M2202	F2203	G2204	D2205	Y2206	M2207	N2208	P2209	D2210	D2214	D2215	R2216	V2217	Y2218	I2219	E2220	I2221	P2222	M2223	L2224	H2225	H2226	F2227	S2228	D2229	V2230	V2231	D2232	Q2233	D2236	R2252	Y2253	V2254	L2255	E2256	S2259	C2262	R2263	K2266	Q2267	H2296	P2300	E2301	I2302	S2303								
K2304	S2305	D2314	R2320	N2321	M2324	K2325	G2326	Q2327	K2328	D2363	E2364	E2367	V2368	M2369	E2370	G2371	V2372	R2373	P2374	A2376	Q2377	A2378	G2379	N2380	K2381	H2382	D2383	E2384	L2385	R2397	S2436	L2453	E2454	L2455	T2456	E2457	V2458	L2485	Q2509	K2510	Q2511	Q2512	A2513	V2514	M2515	E2516	A2517	K2518											
Q2519	R2520	Y2521	M2523	C2524	L2525	D2526	K2527	L2528	A2529	F2530	A2531	S2533	Q2534	V2535	Q2536	E2537	M2538	D2539	M2540	E2541	V2543	E2544	L2545	Q2546	P2547	L2548	E2550	E2551	A2552	K2553	I2554	E2555	N2556	A2557	N2558	M2559	M2560	Q2561	V2562	L2563	E2564	L2565	E2566	S2567	V2568	Q2569	V2570	E2571	A2572	K2573	R2574	Q2575	F2576	V2577	K2578				



L2579	D2580	E2581	E2582	L2583	A2584	S2585	G2586	K2587	A2588	E2589	E2590	A2591	Q2592	A2593	L2594	K2595	N2596	E2597	C2598	E2599	S2600	D2601	L2602	A2603	E2604	A2605	T2606	P2607	A2608	L2609	E2610	A2611	A2612	L2613	S2614	A2615	L2616	D2617	T2618	L2619	K2620	F2621	A2622	D2623	D2624	T2625	L2626	V2627	K2628	S2629	M2630	K2631	N2632	F2633	P2634	S2635	G2636	V2637	K2638
L2639	V2640	M2641	A2642	A2643	V2644	C2645	V2646	M2647	K2648	D2649	L2650	K2651	P2652	E2653	K2654	S2655	D2657	P2658	S2659	G2660	T2661	G2662	G2663	K2664	I2665	L2666	D2667	V2668	W2669	G2670	L2730	M2731	A2732	K2733	E2734	L2735	V2736	D2737	D2738	M2739	A2740	F2681	L2682	R2683	D2684	L2685	K2686	E2687	L2688	D2689	K2690	D2691	N2692	L2693	P2694	V2695	T2696	V2697	M2698
Q2699	K2700	L2701	R2702	L2703	E2704	Y2705	L2706	M2707	N2708	P2709	E2710	P2711	D2712	P2713	P2714	K2715	V2716	A2717	K2718	A2719	S2720	S2721	A2722	E2723	E2724	G2725	L2726	C2727	K2728	W2729	L2730	M2731	A2732	M2733	E2734	V2735	L2736	D2737	D2738	V2739	A2740	K2741	V2742	L2743	A2744	L2685	K2686	E2687	A2748	R2749	L2750	S2751	E2752	A2753	Q2754	V2695	S2755	L2757	A2758
E2759	T2760	M2761	E2762	L2763	L2764	M2765	Q2766	R2767	K2768	A2769	E2770	L2771	A2772	E2773	V2774	E2775	H2776	H2777	L2778	E2779	N2780	L2781	Q2782	M2783	E2784	F2785	L2786	E2787	K2788	L2789	E2790	E2791	K2792	A2793	A2794	L2795	E2796	D2797	Q2798	V2799	E2800	E2801	C2802	A2803	L2804	K2805	L2806	E2807	R2808	A2809	S2810	Q2811	L2812	L2813	G2814	G2815	L2816	G2817	G2818
E2819	K2820	S2821	R2822	W2823	A2824	Q2825	A2826	A2827	D2828	D2829	L2830	Q2831	L2832	T2833	Y2834	G2888	D2889	P2890	V2891	K2892	L2893	R2894	A2895	W2896	N2897	L2898	A2899	G2900	L2901	P2902	E2903	L2908	G2911	V2912	W2933	N2936	S2937	E2938	K2939	E2940	N2941	Q2942	L2943	R2945	F2963	G2964	T2965	P2966	Q2991	G2992									
C2996	L2997	R2998	L2999	G3000	E3001	V3002	L3003	L3004	L3048	G3049	D2829	L3050	V3051	V3052	A3053	K3054	E3055	R3056	F3057	E3058	L3059	E3060	E3061	E3062	K3063	N3064	A3065	L3066	I3067	L3068	G3069	S3070	A3071	A3072	N3073	K3074	L3075	K3076	Q3076	L3077	K3078	D3079	I3080	E3081	K3082	K3083	I3084	Q2942	L2943	R2945	F2963	G2964	T2965	P2966	Q2991	G2992			
D3098	E3099	S3100	A3101	L3102	K3103	V3104	L3105	L3106	L3048	G3049	D2829	L3050	V3051	V3052	A3053	K3054	E3055	R3056	F3057	E3058	L3059	E3060	E3061	E3062	K3063	N3064	A3065	L3066	I3067	L3068	G3069	S3070	A3071	A3072	N3073	K3074	L3075	K3076	Q3076	L3077	K3078	D3079	I3080	E3081	K3082	K3083	I3084	Q2942	L2943	R2945	F2963	G2964	T2965	P2966	Q2991	G2992			
D3098	E3099	S3100	A3101	L3102	K3103	V3104	L3105	L3106	L3048	G3049	D2829	L3050	V3051	V3052	A3053	K3054	E3055	R3056	F3057	E3058	L3059	E3060	E3061	E3062	K3063	N3064	A3065	L3066	I3067	L3068	G3069	S3070	A3071	A3072	N3073	K3074	L3075	K3076	Q3076	L3077	K3078	D3079	I3080	E3081	K3082	K3083	I3084	Q2942	L2943	R2945	F2963	G2964	T2965	P2966	Q2991	G2992			
Y3171	I3172	N3173	S3174	I3175	K3176	D3177	S3178	N3179	K3180	S3181	K3182	L3183	L3184	E3185	K3186	R3187	L3188	R3189	Y3190	L3191	H3194	Y3197	N3198	L3199	Y3200	C3201	N3202	I3203	C3204	R3205	S3206	L3207	F3208	E3209	K3210	D3211	L3214	F3215	S3216	F3217	L3218	A3248	E3249	K3250	N3251	P3252	D3253	W3262	A3273	F3274	R3275	G3276	L3277						
R3278	Q3279	H3280	F3281	C3282	E3283	H3284	I3285	Y3286	K3287	S3288	E3289	E3290	N3299	A3300	K3301	F3302	P3303	A3304	P3305	K3306	D3307	K3308	N3309	L3310	T3332	N3333	Y3334	V3335	T3336	D3337	G3340	K3341	F3349	D3350	L3351	T3352	K3353	S3354	Y3355	L3356	D3357	S3358	N3359	C3360	T3361	I3362	P3363	L3364	I3365	F3366	V3367	F3381	A3382	N3383					
D3384	K3385	S3386	K3387	S3388	G3389	N3390	K3391	F3392	Q3393	A3394	I3395	S3396	L3397	Q3398	Q3399	G3400	Q3401	G3402	P3403	I3404	A3405	A3406	K3407	M3408	I3409	K3410	A3411	A3412	I3413	E3414	E3415	G3416	T3417	W3418	V3419	C3420	L3421	N3422	C3424	H3425	L3426	A3427	V3428	S3429	W3430	M3431	P3432	N3433	F3434	L3434	E3435	K3436	I3437	C3438	T3442	S3443	E3444	T3445	
C3446	N3447	S3448	S3449	F3450	R3451	L3452	W3453	L3454	T3455	S3456	Y3457	P3458	S3459	S3460	K3461	F3462	P3463	V3464	L3465	T3466	L3467	G3470	V3471	K3472	M3473	T3474	R3504	G3505	K3506	E3507	L3508	A3509	W3510	E3511	Y3801	K3512	F3556	I3557	N3558	E3559	Y3560	D3561	T3562	L3563	P3564	F3565	E3566	A3567	L3568	S3569	Y3570	L3571	L3594	A3595	A3596	F3597			
Y3598	N3599	L3600	Y3601	L3602	V3603	E3604	N3605	P3606	H3607	Y3608	K3609	F3610	P3612	S3613	G3614	F3617	A3618	P3619	P3620	K3621	T3660	L3661	F3662	E3663	S3664	L3665	L3666	L3667	T3668	Q3669	G3670	S3671	S3672	Y3801	K3673	Q3674	S3678	P3697	S3698	P3699	F3700	D3701	I3702	E3703	M3704	R3707	K3708	Y3709	P3710	E3714	L3731	I3732							
I3733	T3734	I3735	R3736	N3737	T3738	D3741	D3753	S3754	A3755	L3756	E3757	A3758	L3759	S3760	G3761	S3762	V3765	G3766	K3767	V3768	P3769	I3770	L3771	N3772	A3773	K3774	R3775	L3794	N3795	I3798	D3799	N3800	S3672	Y3801	K3673	Q3674	S3678	P3697	S3698	P3699	F3700	D3701	I3702	E3703	M3704	R3707	K3708	Y3709	P3710	E3714	L3731	I3732							
I3733	T3734	I3735	R3736	N3737	T3738	D3741	D3753	S3754	A3755	L3756	E3757	A3758	L3759	S3760	G3761	S3762	V3765	G3766	K3767	V3768	P3769	I3770	L3771	N3772	A3773	K3774	R3775	L3794	N3795	I3798	D3799	N3800	S3672	Y3801	K3673	Q3674	S3678	P3697	S3698	P3699	F3700	D3701	I3702	E3703	M3704	R3707	K3708	Y3709	P3710	E3714	L3731	I3732							
Y3828	A3829	R3830	K3831	Y3832	T3833	T3834	P3835	E3844	V3845	I3846	P3847	S3848																																															

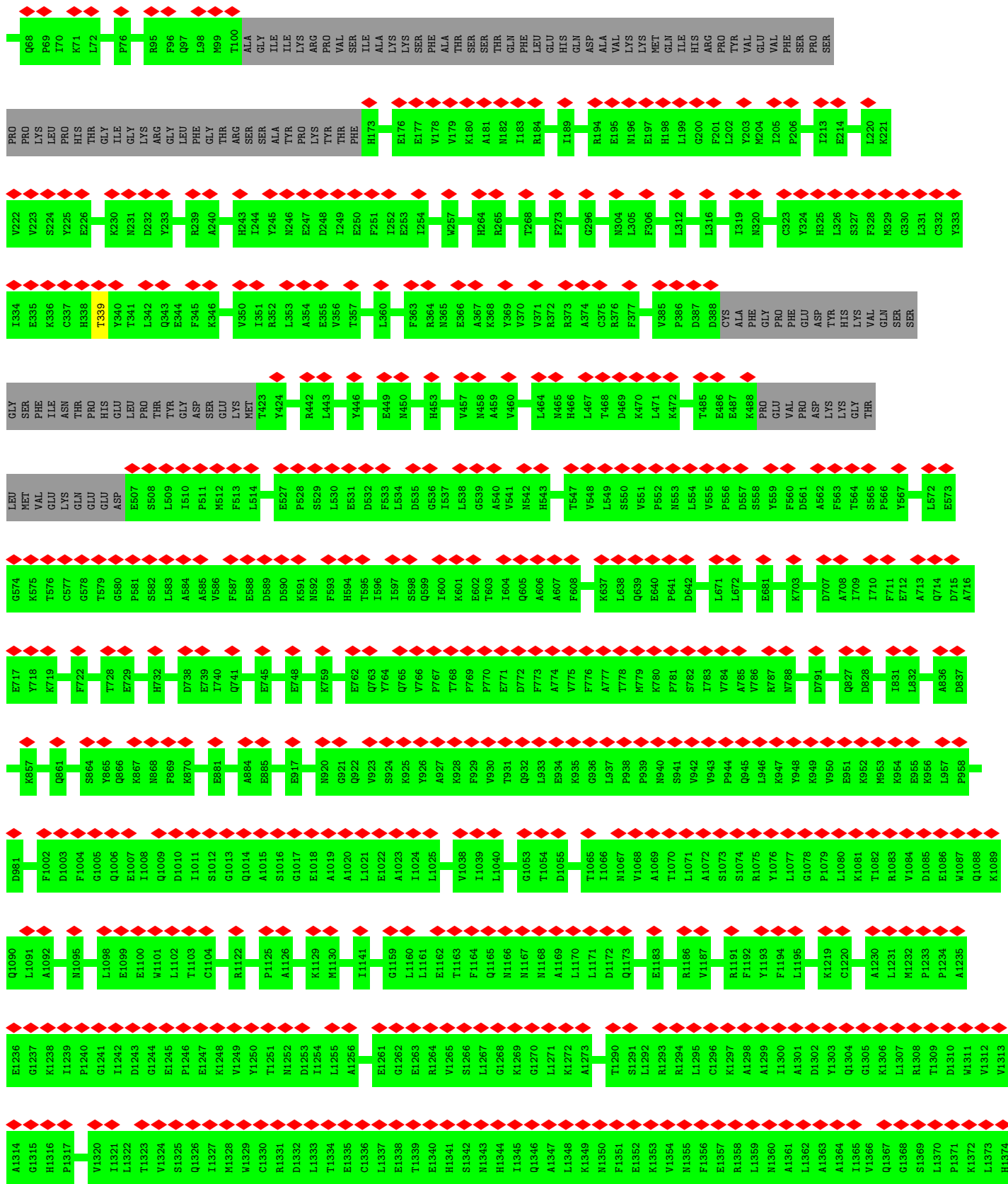

I1377	I1378	L1381	L1382	T1383	L1384	L1385	V1386	H1387	A1388	R1389	D1390	I1391	V1392	T1393	E1394	L1395	V1396	Q1397	S1398	K1399	V1400	E1401	T1402	V1403	E1404	F1406	D1407	W1408	R1410	Q1411	L1412	R1413	Y1414	Y1415	L1416	D1417	I1418	D1419	L1420	D1421	N1422	C1423	V1424	A1425	R1426	M1427	A1428	L1429	F1430	Q1431	Y1432	T1433	L1445	V1446					
I1447	T1448	P1449	L1450	T1451	D1452	C1454	Y1455	L1456	C1457	L1458	M1459	G1460	A1461	L1462	Q1463	L1464	D1465	L1466	G1467	G1468	P1473	A1474	G1475	T1476	G1477	K1478	T1479	E1480	W1481	T1482	K1483	D1484	L1485	A1486	K1487	A1488	L1489	A1490	I1491	Q1492	C1493	L1494	V1495	Y1504	K1505	M1506	M1507	G1508	R1509	F1510	F1511	S1512	G1513	L1514	A1515	Q1516			
S1517	G1518	A1519	W1520	C1521	C1522	F1523	E1532	S1535	V1536	I1537	A1538	Q1539	Q1540	L1541	I1542	L1543	I1544	R1545	M1546	A1547	K1548	A1549	A1550	K1551	L1552	S1553	R1554	F1555	M1556	F1557	E1558	R1559	L1560	E1561	I1562	L1563	L1564	V1565	M1566	M1567	C1568	A1569	A1570	F1571	L1591	F1592	F1595	A1596	M1597	M1598	V1599	P1600	L1601	Y1602	A1603				
L1604	I1605	E1607	Y1611	F1615	E1616	S1617	S1618	K1619	I1620	L1621	A1622	K1623	M1625	T1626	Q1627	M1628	Y1629	K1630	L1631	C1632	S1633	E1634	Q1635	L1636	S1637	F1638	Q1639	D1640	H1641	Y1642	D1643	F1644	L1659	K1660	R1661	E1662	M1663	P1664	D1665	L1666	M1667	E1668	D1669	V1670	V1671	L1672	I1673	R1674	A1675	L1676	Q1677	M1680	L1681						
P1682	K1683	F1684	L1685	T1686	D1687	A1688	L1690	L1691	F1692	S1693	G1694	I1695	I1696	S1697	D1698	L1699	F1700	P1701	V1702	V1703	Q1704	I1705	F1706	E1707	H1708	D1709	Y1710	G1711	I1712	L1713	Q1714	H1715	T1716	I1717	V1718	D1719	M1720	M1721	M1722	R1723	Q1724	M1725	L1726	Q1727	P1728	E1729	M1730	C1731	M1732	V1733	I1737	Q1738	F1739	Y1740	E1742				
M1743	L1744	H1747	G1748	G1756	T1761	H1765	L1766	A1767	E1768	T1769	L1770	G1771	M1772	L1773	Q1774	L1775	L1776	G1777	I1778	H1779	M1780	S1781	F1782	Y1783	Q1784	A1785	V1786	T1787	L1788	Y1789	V1790	L1791	M1792	P1793	K1794	L1801	L1808	T1809	L1810	M1817	A1818	D1827	T1828	S1829	I1830	D1831	H1832	K1833	M1834	I1835	I1836	Q1925	E1926	Y1927	I1928	L1929			
S1837	V1841	D1842	A1843	L1844	W1845	I1846	E1847	M1848	M1849	M1850	T1851	V1852	L1853	M1856	T1870	P1871	Q1872	I1873	H1874	M1875	L1876	F1877	A1885	S1886	P1887	A1888	T1889	V1890	D1899	P1900	E1901	E1902	L1903	K1904	W1905	M1906	P1907	Y1908	V1909	K1910	T1911	W1912	M1913	K1914	G1915	I1916	S1917	K1918	Q1925	E1926	Y1927	I1928	L1929						
M1930	L1931	F1932	Q1933	R1934	Y1935	V1936	D1937	E1938	G1939	L1940	H1941	F1942	M1944	G1947	S1948	Q1949	A1950	D1955	I1956	L1957	K1958	T1961	L1962	C1963	C1964	L1965	L1966	E1967	S1968	L1969	I1970	L1971	T1992	F1993	V1994	F1995	C1996	Y1997	L1998	M1999	S2000	L2001	G2002	G2003	M2004	L2005	T2006	E2007	M2008	Y2009	Y2010	D2011	S2012	F2013					
D2014	T2015	F2016	I2017	T2018	R2019	Q2020	F2021	D2022	D2023	M2024	P2025	D2026	A2027	R2028	P2030	N2031	S2032	D2034	L2035	W2036	S2037	H2039	M2040	D2041	F2042	D2043	L2047	D2048	P2049	W2050	E2051	R2052	I2053	I2054	P2055	T2056	V2063	P2071	T2072	T2073	D2074	T2075	T2076	R2077	Y2078	G2079	L2080	L2081	M2082	E2083	K2084	L2086							
A2087	V2088	I2097	T2098	G2099	V2100	G2101	K2102	S2103	V2104	I2105	A2106	K2112	A2128	M2149	D2165	L2166	M2167	M2168	P2169	R2170	L2171	D2172	G2177	Q2187	D2188	F2199	C2212	A2213	P2214	P2215	G2216	G2217	G2218	R2219	M2220	P2221	I2227	K2228	H2229	L2233	C2234	L2235	P2236	M2237	P2238	S2239	E2240	H2241											
S2242	L2243	K2244	Q2245	I2246	F2247	Q2248	A2249	L2250	L2251	M2252	G2253	F2254	L2255	S2256	D2257	F2258	P2259	P2260	A2261	V2262	K2263	Q2264	T2265	A2266	S2267	S2268	I2269	V2270	E2271	A2272	S2273	V2274	E2275	L2276	Y2277	N2278	K2279	M2280	S2281	V2282	D2283	L2284	L2285	P2286	T2287	P2288	V2294	F2295	M2296	L2297	R2298	D2299	L2300	C2303	V2304	Q2305	G2306		
I2307	L2308	Q2309	C2310	D2311	P2312	G2313	T2314	I2315	R2316	E2317	E2318	I2319	Q2320	I2321	F2322	R2323	L2324	F2325	C2326	H2327	E2328	C2329	Q2330	R2331	H2334	D2335	M2340	H2344	H2347	T2351	E2352	M2353	A2354	N2355	K2356	H2357	F2358	G2359	I2360	A2361	L2362	D2363	L2364	E2365	Y2366	F2367	L2368	N2369	K2370	P2371	I2372	I2373	F2374	G2375					
D2376	F2377	L2378	K2379	F2380	G2381	A2382	D2383	K2384	A2385	D2386	R2387	L2388	Y2389	D2390	D2391	D2392	P2393	D2394	I2395	E2396	D2397	T2398	A2399	M2400	V2401	L2402	Q2403	D2404	Y2405	L2406	D2407	D2408	Y2409	M2410	L2411	T2412	N2413	P2414	K2415	E2416	V2417	K2418	L2419	V2420	F2421	F2422	D2423	D2424	A2425	L2426	E2427	H2428	V2429	S2430	R2431	L2432	A2433	R2434	M2435

R3404	R3405	P3406	K3407	P3408	E3409	E3410	P3411	K3412	L3413	P3414	T3415	A3416	P3417	K3418	S3419	K3420	C3421	C3422	D3423	L3424	E3425	E3426	S3427	P3428	P3429	V3430	F3431	K3432	H3433	L3434	T3435	K3436	E3437	K3438	L3439	S3440	H3441	P3442	G3443	S3444	L3445	R3446	D3447	A3448	S3449	F3450	E3451	P3452	F3453	L3454	N3455	P3456	K3457	L3458	V3459	L3460	E3461	K3462	Y3463				
D3344	V3345	L3346	L3347	E3348	Q3349	T3350	L3351	L3352	T3353	A3354	V3355	V3356	N3357	V3358	S3359	K3360	L3361	L3362	F3363	E3364	Q3365	H3366	K3367	L3368	I3369	Y3370	S3371	F3372	M3373	L3374	C3375	V3376	E3377	K3378	M3379	K3380	Q3381	Q3382	G3383	T3384	L3385	S3386	D3387	A3388	E3389	V3390	N3391	F3392	F3393	L3394	K3395	G3396	S3397	A3398	G3399	L3400	E3401	K3402	E3403				
T5280	E3281	Q3282	M3283	L3284	N3285	V3286	A3287	R3288	E3289	K3290	N3291	R3292	P3293	V3294	A3295	T3296	Q3297	G3298	S3299	V3300	M3301	Q3302	F3303	V3304	L3305	A3306	S3307	L3308	S3309	E3310	L3311	D3312	P3313	M3314	Y3315	L3316	I3317	D3318	T3319	F3320	L3321	F3322	L3323	F3324	M3325	N3326	T3327	L3328	T3329	L3330	E3331	T3332	S3333	V3334	K3335	T3336	E3337	N3338	L3339	Q3340	Q3341	R3342	L3343
K3220	L3221	I3222	V3223	I3224	I3225	N3226	T3227	D3228	K3229	N3230	Q3231	L3232	K3233	T3234	I3235	E3236	E3237	K3238	I3239	L3240	R3241	M3242	L3243	F3244	S3245	S3246	E3247	R3248	N3249	I3250	L3251	I3252	R3253	E3254	E3255	L3256	I3257	D3258	T3259	L3260	Q3261	D3262	S3263	K3264	T3265	T3266	T3267	G3268	R3269	S3270	K3271	R3272	L3273	E3274	G3275	E3276	L3277	Q3278	L3279	Q3280	L3281	E3282	L3283
E3113	N3114	S3115	I3116	L3117	R3118	G3119	L3120	V3121	V3122	P3137	I3138	L3139	L3140	Q3141	K3142	I3143	F3144	L3145	S3146	G3147	G3148	R3149	L3150	L3151	I3152	R3153	L3154	D3155	I3156	L3157	Y3158	D3159	D3160	Y3161	K3162	K3163	N3164	F3165	L3166	F3167	Y3168	T3169	L3203	V3206	V3207	R3208	L3209	E3210	K3211	F3212	R3213	E3214	E3215	E3216	Q3217	R3218	I3219						
K3220	L3221	I3222	V3223	I3224	I3225	N3226	T3227	D3228	K3229	N3230	Q3231	L3232	K3233	T3234	I3235	E3236	E3237	K3238	I3239	L3240	R3241	M3242	L3243	F3244	S3245	S3246	E3247	R3248	N3249	I3250	L3251	I3252	R3253	E3254	E3255	L3256	I3257	D3258	T3259	L3260	Q3261	D3262	S3263	K3264	T3265	T3266	T3267	G3268	R3269	S3270	K3271	R3272	L3273	E3274	G3275	E3276	L3277	Q3278	L3279	Q3280	L3281	E3282	L3283
D3344	V3345	L3346	L3347	E3348	Q3349	T3350	L3351	L3352	T3353	A3354	V3355	V3356	N3357	V3358	S3359	K3360	L3361	L3362	F3363	E3364	Q3365	H3366	K3367	L3368	I3369	Y3370	S3371	F3372	M3373	L3374	C3375	V3376	E3377	K3378	M3379	K3380	Q3381	Q3382	G3383	T3384	L3385	S3386	D3387	A3388	E3389	V3390	N3391	F3392	F3393	L3394	K3395	G3396	S3397	A3398	G3399	L3400	E3401	K3402	E3403				

R159	L160	L161	A162	Q163	T164	D165	F166	Y171	E172	P173	F179	L182	L200	S201	L202	D203	I204	F209	S210	L213	D214	S215	N216	K217	L218	M219	P220	R221	H222	L223	Q226	H227	P228	Q229	T230	I231	E232	Q233	G234	H235	D236	P240	I241	L245	K246	D249	N250	E251	D252										
F253	D254	C255	R256	E260	N263	M264	G265	L266	E267	P268	G269	S270	L271	D272	R273	K274	G278	K279	A280	L281	T284	D285	L288	G289	D292	P293	K294	S295	Q296	K297	L298	K299	C303	E304	V307	L308	D309	Y310	D311	E312	E313	K314	K315	L316	Y317	H320	K321	T322	D323	E324									
K325	G326	L327	V328	R329	D330	E331	M332	G333	R334	P335	I336	L337	G340	V341	T342	T343	E344	G345	R346	P347	P348	L349	C352	Q353	Y354	K355	V356	P357	R358	I359	Q360	C364	A365	F371	R374	V375	V376	Q377	A380	D389	L381	N384	A387	Y391	M392	L393	Y394	M398	P399	S400									
D401	G402	Q403	H404	V405	I406	S407	E408	H417	A418	L419	S420	T421	R425	K426	G427	P428	S429	V430	H433	L434	D455	S459	P462	E463	T464	F465	S466	V467	V468	T469	L470	P471	K472	K473	E474	E475	E476	Q477	V478	P479	E480	R481	G482	S485	V486	P487	K488	H492	E496	D497									
F498	T499	F500	L503	L504	T505	R506	V509	S513	V516	R517	C520	N521	K522	V523	T524	A525	M526	S527	L528	F529	H530	S531	S532	L533	S534	K535	Y536	S537	H538	L539	E540	E543	Q546	S547	F550	S551	Q552	V553	M555	F556	L557	K558	D559	S560	M561	I562	L565	K566	V567										
A568	M569	R570	S571	S572	L573	R574	D575	M576	S577	K578	Y581	N582	L583	Y584	E585	T586	E589	K598	E601	L602	Y605	M606	D609	R612	F613	Q616	D617	S618	L619	A620	S621	F622	S623	Q624	F625	L626	S627	D628	T629	C630	C631	S632	V633	L634	N635	C636	T637	D638	M640	V641									
M642	G643	D644	D645	L646	T647	M648	S649	P650	S651	R652	P653	R654	K655	M656	P657	L658	F659	L660	M661	D662	L663	V664	L665	D666	S667	S668	G669	V670	H671	Y672	S673	T674	P675	L676	E677	Q678	F679	E680	A681	S682	L683	L684	N685	L686	F687	D688	K689	G690	L691	L692	A693	T694	H695	A696	V697	P698	Q699	L700	E701
K702	L703	V704	M705	E706	D707	L708	F709	L710	S711	G712	D713	P714	L715	L716	E717	S718	V719	G720	L721	H722	E723	P724	L725	V726	E727	E728	L729	R730	A731	T732	L733	A734	S735	A736	V737	S738	K739	A740	M741	I742	S743	L744	N745	L746	D747	A748	K749	E750	Y751	R752	K753	Y754	L755	E756	L757	M758	N759	M760	D761
I762	A763	S764	F765	L766	K767	T768	Y769	Q770	T771	Q772	G773	L774	L775	A776	Q777	E778	E781	L784	T785	R788	E789	K790	E791	I792	L793	E794	N797	E798	V799	S799	S800	I801	I802	I803	G804	F806	Y807	I808	N809	T810	D811	M812	K813	D1183	L817	S818	K819	K820	R821	K822	A823	L824							
K887	D890	D891	Y892	Q893	V894	M895	D896	E897	F898	I941	M944	N947	N948	F949	Q950	E951	K952	L953	E954	G955	L958	H973	E974	N977	E978	V979	R981	K984	Q985	D988	L1082	E1089	N1119	I1120	M1121	W1169	D1183	D1191	P1211	M1225																			
Q1258	P1261	V1262	K1265	E1283	D1293	L1294	M1295	L1297	D1298	S1299	L1300	R1301	D1302	T1320	T1347	A1348	V1349	Q1350	P1351	M1359	I1360	I1361	R1362	L1363	L1364	F1365	Q1366	E1367	D1368	L1369	E1370	I1371	T1372	M1374	Y1375	S1376	A1377	E1378	G1379	E1380	I1381	V1382	Q1383	Y1420	P1421	R1425	T1426	Q1427											
W1428	V1429	L1430	M1431	W1432	P1433	Y1444	Y1445	T1446	M1447	E1448	V1449	A1450	E1451	A1452	L1453	E1454	A1455	G1456	M1457	L1458	R1459	S1460	Q1461	L1462	F1463	P1464	Q1465	L1466	C1467	Q1468	Q1469	L1470	S1471	D1472	L1473	L1476	V1477	S1482	R1483	M1484	Q1485	R1486	A1487	V1488	L1489	S1490	A1491	L1492	I1493	V1494	I1495	E1496	V1497	H1498	A1499	K1500			
D1501	V1502	V1503	S1504	K1505	L1506	I1507	Q1508	V1511	V1512	S1513	W1514	Q1518	M1519	M1550	S1551	G1552	R1553	L1554	W1555	I1556	T1557	A1578	P1579	A1580	G1581	P1582	A1583	G1584	T1585	G1586	K1587	T1588	E1589	T1590	M1606	C1607	S1608	D1609	D1633	E1634	F1635	M1636	R1637	I1681	T1682	M1683	M1684	P1685	G1686	Y1687	A1688	G1689							

R1690	T1691	E1692	L1693	R1702	P1703	V1704	A1705	M1706	M1707	P1708	D1710	Y1711	A1712	M1713	I1714	T1715	E1716	I1717	S1718	L1719	V1720	S1721	S1728	V1729	L1730	A1731	K1732	K1733	I1734	T1735	I1736	T1737	F1738	K1739	L1740	S1741	E1742	E1743	Q1744	L1745	S1746	E1747	Q1748	D1749	H1750	V1751	D1752	F1753	G1754	M1755	R1756	A1757	N1758	K1759	T1760	V1761				
I1762	L1782	R1783	A1784	I1785	R1786	D1787	V1788	M1789	V1790	P1791	K1792	F1793	L1794	Q1795	E1796	D1797	L1798	K1799	L1800	F1801	S1802	G1803	I1804	V1805	S1806	L1807	L1808	F1809	P1810	K1811	I1812	K1813	E1814	G1913	F1914	F1915	D1916	L1917	E1918	Q1919	L1920	S1921	E1922	Q1923	D1924	G1925	S1928	A1953	I1956	E1957	N1958	M1959	L1960	T1961						
V1962	L1963	D1964	D1965	M1966	K1967	K1968	L1969	C1970	L1971	S1972	G1973	G1974	E1975	I1976	I1977	K1978	D1991	L1992	A1993	V1994	A1995	S1996	P1997	A1998	V1999	W2000	S2001	R2002	C2003	G2004	M2005	P2027	P2028	L2029	P2081	P2082	L2083	L2084	R2085	E2086	G2087	L2088	K2089	K2090	I2091	P2092	S2093	E2094	K2095	L2096	S2097	R2098	L2142	L2143						
D2157	A2158	G2159	I2160	G2161	S2162	T2163	N2164	D2165	S2166	E2167	D2168	E2169	E2170	E2171	E2172	Y2173	K2174	Q2175	V2176	A2177	V2191	P2192	D2193	T2194	W2195	K2278	I2327	I2328	I2381	L2382	G2383	M2384	R2385	L2386	D2387	Q2388	L2389	L2390	G2391	E2392	K2393	S2394	Y2395	R2396	E2397	R2398	V2399	P2400	G2401	A2402	P2403	H2404	I2405	A2406	H2407					
F2408	T2409	G2449	M2450	L2451	M2452	D2453	D2454	P2455	A2456	K2457	V2458	E2459	D2460	Q2461	Q2462	Q2463	L2464	R2465	R2466	L2467	W2468	Y2469	H2470	E2483	E2484	S2487	W2488	F2489	D2490	L2491	L2492	L2493	K2494	R2495	C2496	M2497	E2498	Q2499	W2500	E2501	V2502	T2503	S2504	N2505	K2506	V2507	C2508	P2509	F2510	G2511	P2512	L2513	L2514	Q2515	D2516	D2517				
F2518	M2519	S2520	P2521	S2522	S2523	D2524	V2525	R2526	S2527	Y2528	E2529	L2530	T2531	T2532	S2533	E2534	S2535	K2536	M2537	M2538	V2540	I2541	E2542	E2543	Y2544	I2545	E2546	D2547	Y2548	N2549	Q2550	I2551	M2552	T2553	A2554	K2555	L2556	K2557	L2558	V2559	L2560	F2561	M2562	D2563	Q2564	A2565	M2566	S2567	I2568	C2569	R2570	L2571	I2572	L2573	S2574	R2575	K2576	G2589		
S2590	G2591	R2592	S2593	S2594	L2595	T2596	R2597	L2598	S2600	H2601	A2602	M2603	A2604	C2607	F2608	Q2609	E2611	I2610	E2611	L2612	S2613	Y2616	S2619	E2620	L2642	F2643	S2644	D2645	T2646	Q2647	I2648	K2649	Y2670	T2671	A2672	D2673	E2674	Q2675	D2676	E2688	Q2689	G2690	E2748	K2751	S2752	V2753	A2754	T2755	V2756	F2757	L2758									
M2759	E2760	I2761	P2762	E2763	L2764	E2765	S2766	Q2767	E2769	E2770	L2771	Q2772	G2773	L2774	I2775	K2805	L2806	E2809	L2810	L2811	H2812	S2815	L2816	L2817	L2818	G2819	K2822	L2823	K2826	T2827	A2828	K2829	M2830	R2831	M2832	K2833	S2834	G2835	L2836	D2837	L2839	L2840	R2841	T2842	S2843	E2844	D2845	V2846	A2847	K2848	M2849									
Q2850	E2851	D2852	L2853	E2854	S2855	M2856	H2857	P2858	L2859	L2860	E2861	E2862	A2863	A2864	K2865	D2866	T2867	M2868	L2869	T2870	M2871	E2872	Q2873	L2874	K2875	V2876	D2877	L2878	A2879	I2880	E2881	E2882	E2883	T2884	R2885	M2886	S2887	V2888	Q2889	T2890	E2891	E2892	L2893	K2894	A2895	M2896	E2897	K2898	L2899	K2900	K2901	A2902	Q2903	A2904	I2905	L2906	D2907	D2908	A2909	
Q2910	K2911	D2912	L2913	D2914	E2915	A2916	L2917	P2918	A2919	L2920	D2921	A2922	A2923	L2924	A2925	S2926	L2927	R2928	M2929	L2930	M2931	K2932	M2933	D2934	V2935	T2936	E2937	V2938	R2939	A2940	M2941	Q2942	R2943	P2944	P2945	P2946	G2947	V2948	K2949	L2950	V2951	I2952	E2953	A2954	V2955	C2956	I2957	K2958	K2959	G2960	I2961	K2962	P2963	K2964	K2965	V2966	G2968	E2969		
K2970	P2971	G2972	T2973	K2974	V2975	D2976	D2977	Y2978	W2979	E2980	P2981	G2982	K2983	G2984	L2985	L2986	Q2987	D2988	P2989	G2990	H2991	F2992	L2993	E2994	S2995	L2996	F2997	K2998	F2999	D3000	K3001	D3002	N3003	I3004	G3005	D3006	P2946	V3007	V3008	I3009	K3010	A3011	I3012	Q3013	P3014	Y3015	I3016	N3017	N3018	E3019	E3020	F3021	Q3022	P3023	A3024	T3025	I3026	K3027	K3028	V3029
S3030	K3031	A3032	C3033	T3034	S3035	I3036	C3037	W3038	V3039	V3040	R3041	A3042	M3043	H3044	K3045	Y3046	H3047	F3048	V3049	A3050	K3051	A3052	V3053	E3054	P3055	K3056	R3057	Q3058	A3059	L3060	L3061	A3062	A3063	Q3064	D3065	D3066	L3067	G3068	V3069	T3070	Q3071	R3072	I3073	L3074	D3075	E3076	A3077	K3078	Q3079	R3080	L3081	R3082	E3083	V3084	E3085	D3086	G3087	I3088	A3089	
T3090	H3091	Q3092	A3093	K3094	V3095	R3096	E3097	C3098	L3099	T3100	K3101	K3102	E3103	E3104	L3105	E3106	L3107	K3108	C3109	E3110	Q3111	C3112	E3113	Q3114	K3115	L3116	G3117	R3118	A3119	G3120	K3121	L3122	K3124	G3125	L3126	S3127	D3128	E3129	K3130	V3131	R3132	W3133	Q3134	T3136	V3137	E3138	N3139	L3140	Q3141	Y3142	K3143	L3144	K3145	S3148	D3174					

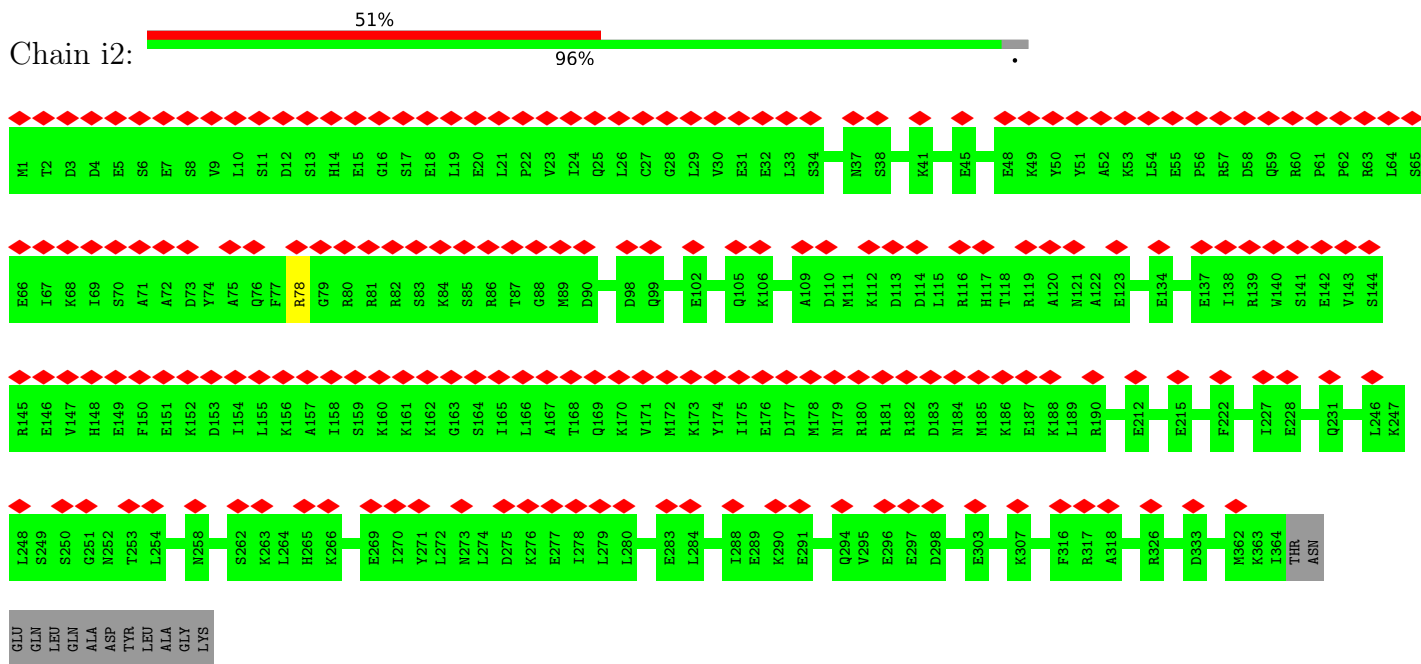

• Molecule 79: Cilia- and flagella-associated protein 299

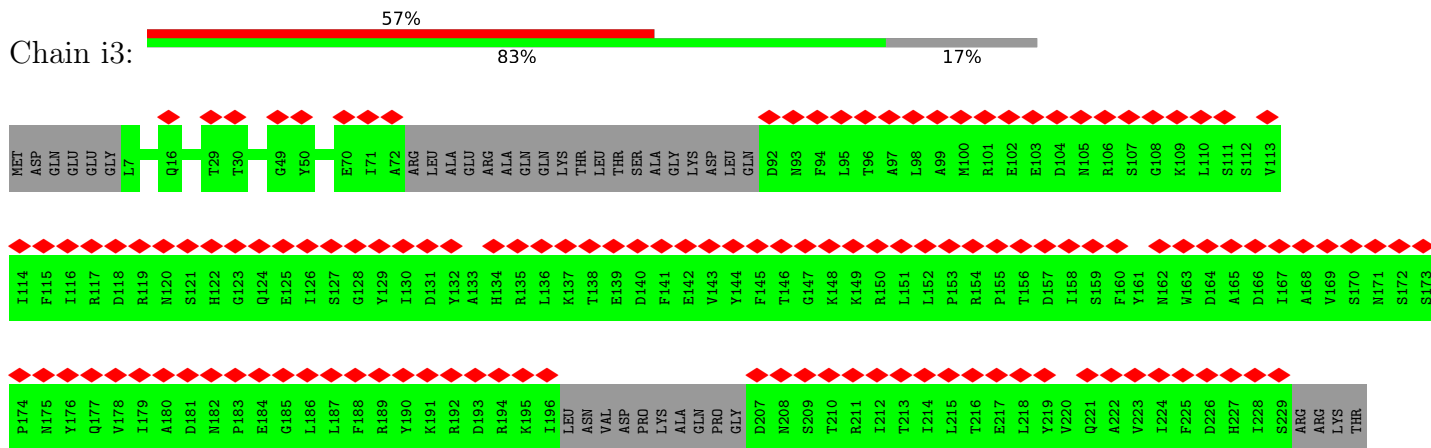

• Molecule 80: Cilia- and flagella-associated protein 57

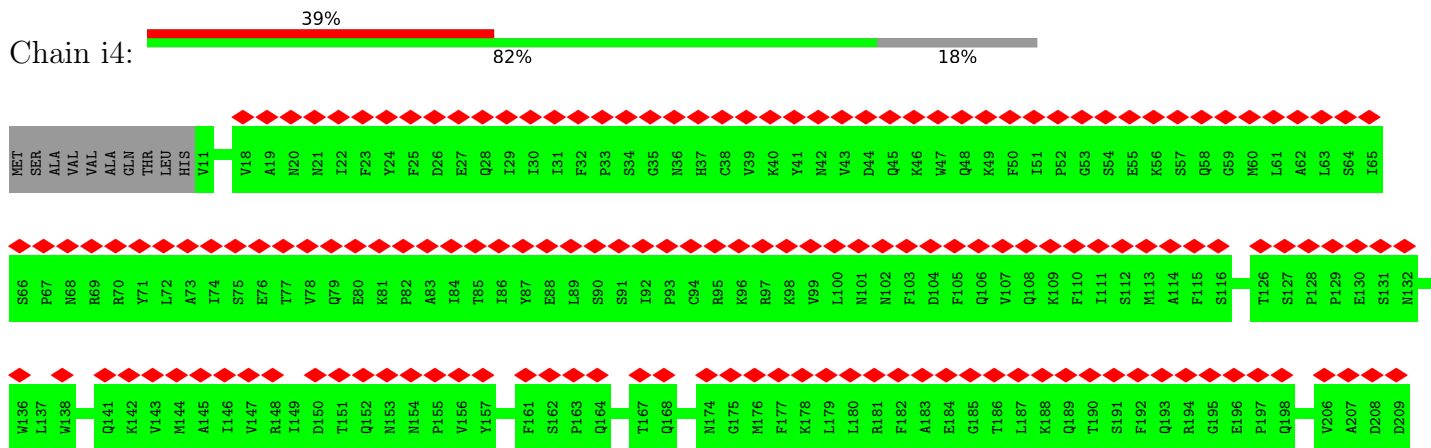

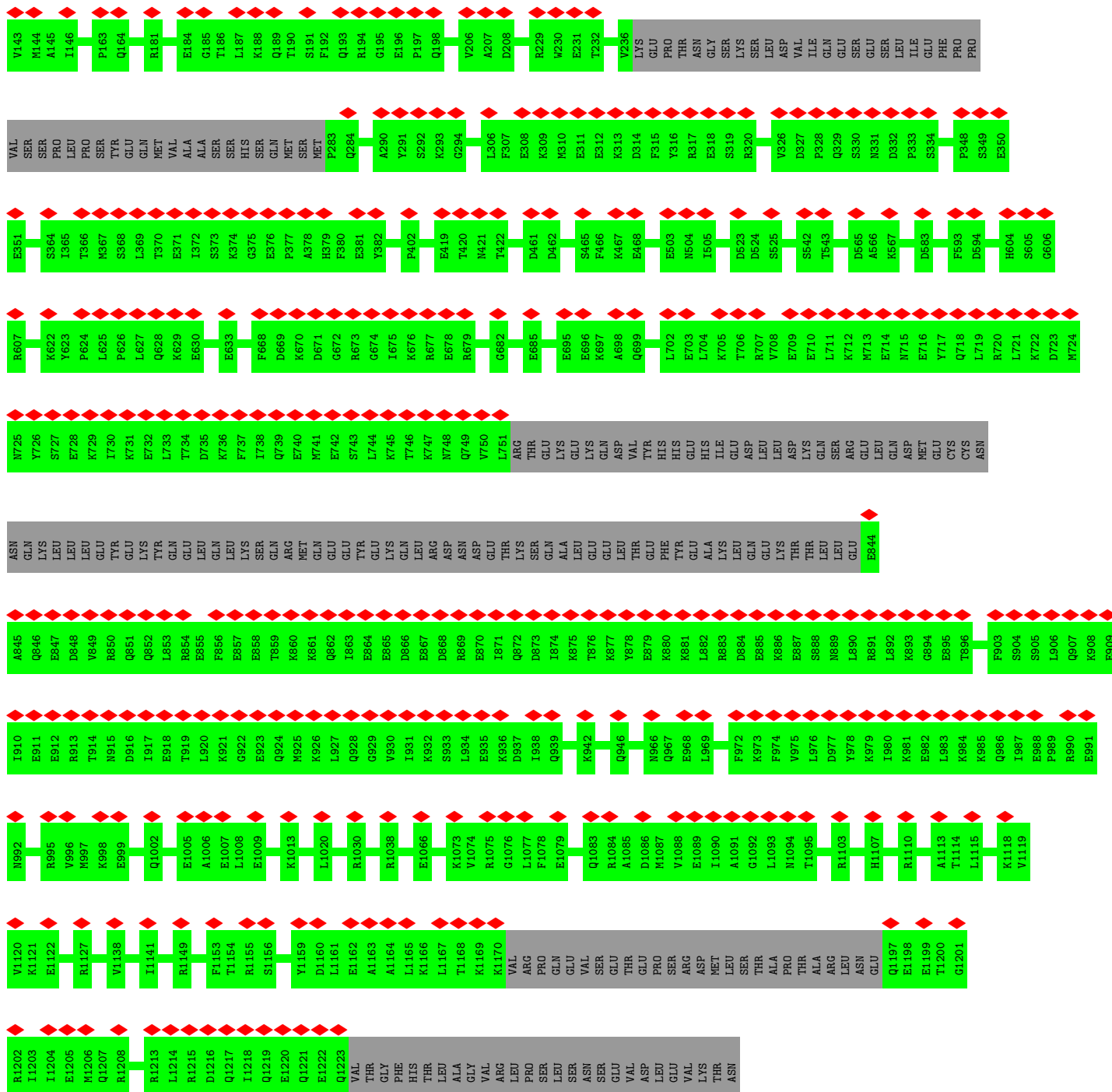

• Molecule 81: Cilia- and flagella-associated protein 43

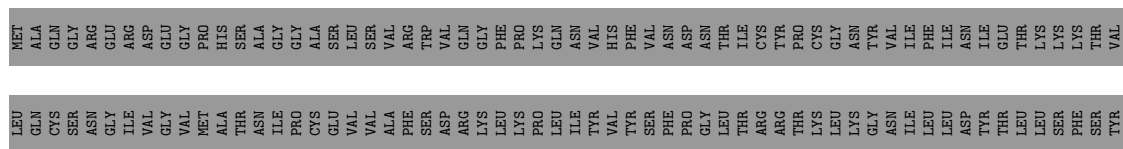

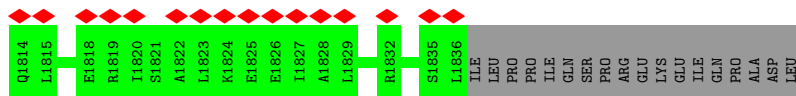

● Molecule 82: Cilia- and flagella-associated protein 44

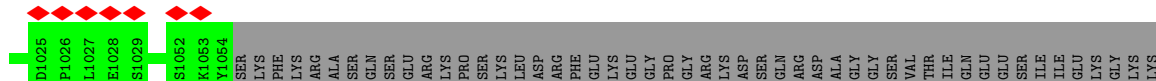
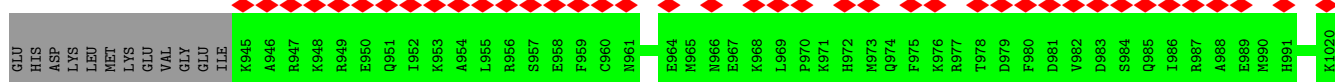
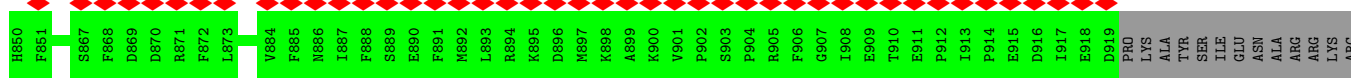
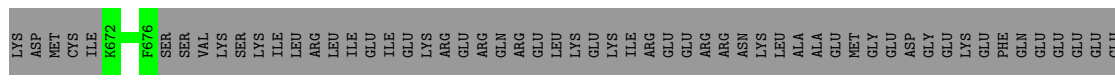
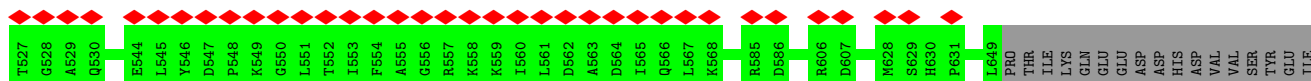
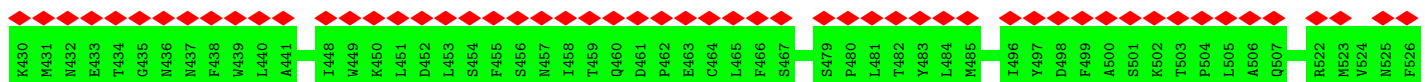
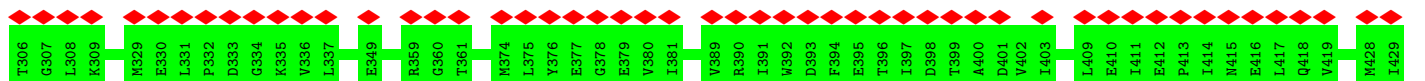
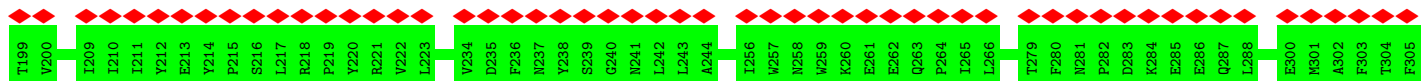
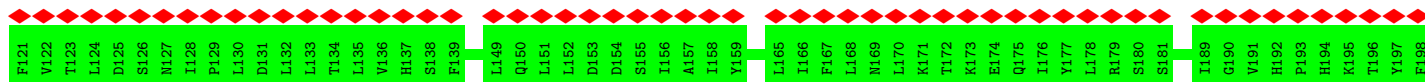
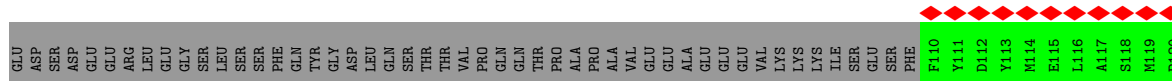
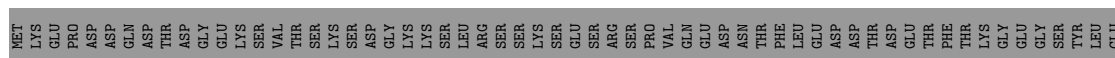
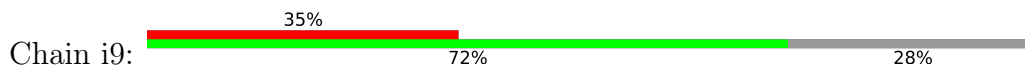

LEU	R363	E364	V365	E366	A367	S368	K369	K370	Q371	A372	E373	L374	D375	R376	K377	A378	M379	D380	E381	L382	L383	R384	E385	R386	D387	I388	L389	N390	K391	N392	M393	L394	K395	A396	V397	N398	A399	T400	Q401	K402	Q403	T404	D405	L406	V407	K408	L409	H410	E411	Q412	A413	K414	R415	N416	L417	E418	G419	E420		
I421	Q422	N423	Y424	K425	D426	E427	A428	Q429	K430	Q431	R432	K433	I434	I435	F436	H437	L438	E439	K440	E441	R442	D443	R444	Y445	I446	N447	Q448	A449	S450	D451	L452	T453	Q454	K455	V456	L457	K518	M458	N459	M460	E461	D462	I463	K464	V465	R466	E467	T468	Q469	I470	F471	D472	Y473	R474	K475	K476	I477	E478	E479	S480
E481	I482	K483	L484	K485	Q486	Q487	Q488	N489	L490	Y491	E492	A493	A494	R495	S496	D497	R498	N499	E500	Y501	S502	K503	N504	L505	V506	E507	A508	Q509	D510	E511	I512	T513	D514	M515	K516	R517	K518	L519	K520	I521	M522	I523	H524	Q525	V526	D527	E528	L529	K530	E531	D532	Y533	S534	A535	K536	E537	S538	A539	L540	
V541	K542	L543	H544	L545	E546	Q547	Q548	R549	I550	E551	K552	E553	K554	E555	T556	K558	A559	E560	L561	Q562	K563	L564	R565	Q566	Q567	A568	L569	E570	T571	K572	H573	F574	I575	E576	K577	Q578	E579	A580	E581	E582	R583	K584	L585	L586	R587	I588	I589	A590	E591	A592	D593	G594	E595	R596	L597	R598	Q599	K600		
K601	E602	L603	D604	Q605	V606	I607	S608	E609	R610	D611	I612	L613	G614	S615	Q616	L617	V618	R619	R620	N621	Q622	E623	L624	A625	Y628	E629	I633	N639	K646	L649	E650	D651	M652	R653	I654	L655	R656	L657	E658	L662	K666	G667	A670	R671	S672	M673	A674	N675	V676	E677	E678									
L679	R680	Q681	E682	H685	E689	T695	R696	C697	R698	L700	A699	Q804	E701	L704	E705	N706	W713	R714	K715	L716	E717	A718	S719	Q728	H731	E742	E746	L749	L750	D651	M652	R653	I654	L655	R656	L657	E658	L662	K666	G667	A670	R671	S672	M673	A674	N675	V676	E677	E678											
L779	R782	H785	D786	Q789	L798	N799	M600	V603	S605	K606	E607	V608	R609	Y610	E611	L615	T616	N617	E618	L619	A620	ASN	LEU	LYS	LYS	LYS	TYR	LEU	ALA	GLN	LYS	ARG	ARG	LYS	ASN	ASN	LYS	LYS	ASN	LYS	ASP	TYR	ASN	LYS	LYS	THR	THR	LEU	MET											
VAL	LYS	PRO	ASN	PRO	GLY	THR	GLY	PHE	GLY	GLY	PHE	PRO	LEU	ARG	SER	THR	LYS	MET	THR	PHE	VAL	ASN	LEU	THR	LEU	VAL	GLN	LEU	THR	THR	LEU	LEU	LYS	LYS	ASN	ASN	LYS	LYS	ASP	TYR	ASN	LYS	LYS	THR	THR	LEU	MET													

● Molecule 83: Cilia- and flagella-associated protein 58

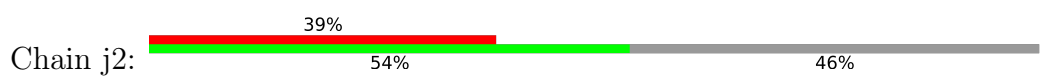

MET	ALA	GLU	GLN	GLY	THR	VAL	ASN	LEU	VAL	GLY	GLY	VAL	GLN	LEU	GLY	GLU	GLY	GLN	GLN	LEU	VAL	THR	GLY	GLY	ASP	ARG	GLU	GLY	ASP	ASP	GLY	GLY	THR	GLN	ASN	ASN	ASN	GLY	GLY	ARG	ARG	LEU	VAL	GLY	VAL	GLY	GLY	VAL	GLY	GLY	LEU
MET	ALA	GLN	GLY	GLY	ASN	VAL	ASN	ALA	VAL	VAL	GLN	VAL	GLN	GLU	GLN	GLY	GLY	GLN	GLN	LEU	LEU	GLY	GLY	GLY	GLY	LEU	GLU	GLU	GLU	GLU	GLU	GLU	GLU	GLU	GLN	GLN	GLN	GLN	GLN	GLY	THR	THR	THR	GLY	GLY	GLY	GLY	GLY	GLY	THR	
GLU	GLN	GLN	GLY	THR	VAL	VAL	ASN	ALA	VAL	VAL	GLN	VAL	GLN	GLU	GLN	GLY	GLY	GLN	GLN	LEU	LEU	GLY	GLY	GLY	GLY	LEU	GLU	GLU	GLU	GLU	GLU	GLU	GLU	GLN	GLN	GLN	GLN	GLN	GLY	THR	THR	THR	GLY	GLY	GLY	GLY	GLY	GLY	THR		
ALA	LEU	GLN	TYR	GLY	GLN	VAL	LYS	LEU	VAL	VAL	GLN	VAL	GLN	GLU	GLY	GLY	GLY	GLN	GLN	LEU	LEU	GLY	GLY	GLY	LEU	GLU	GLU	GLU	GLU	GLU	GLU	GLU	GLN	GLN	GLN	GLN	GLN	GLY	GLY	THR	THR	THR	GLY	GLY	GLY	GLY	GLY	GLY	THR		
GLU	ASN	GLN	GLY	ALA	GLU	GLU	LYS	LEU	VAL	VAL	GLY	VAL	GLN	GLY	GLY	GLY	GLY	GLN	GLN	LEU	LEU	GLY	GLY	GLY	LEU	GLU	GLU	GLU	GLU	GLU	GLU	GLU	GLY	GLN	GLN	GLN	GLN	GLY	GLY	THR	THR	THR	GLY	GLY	GLY	GLY	GLY	GLY	THR		

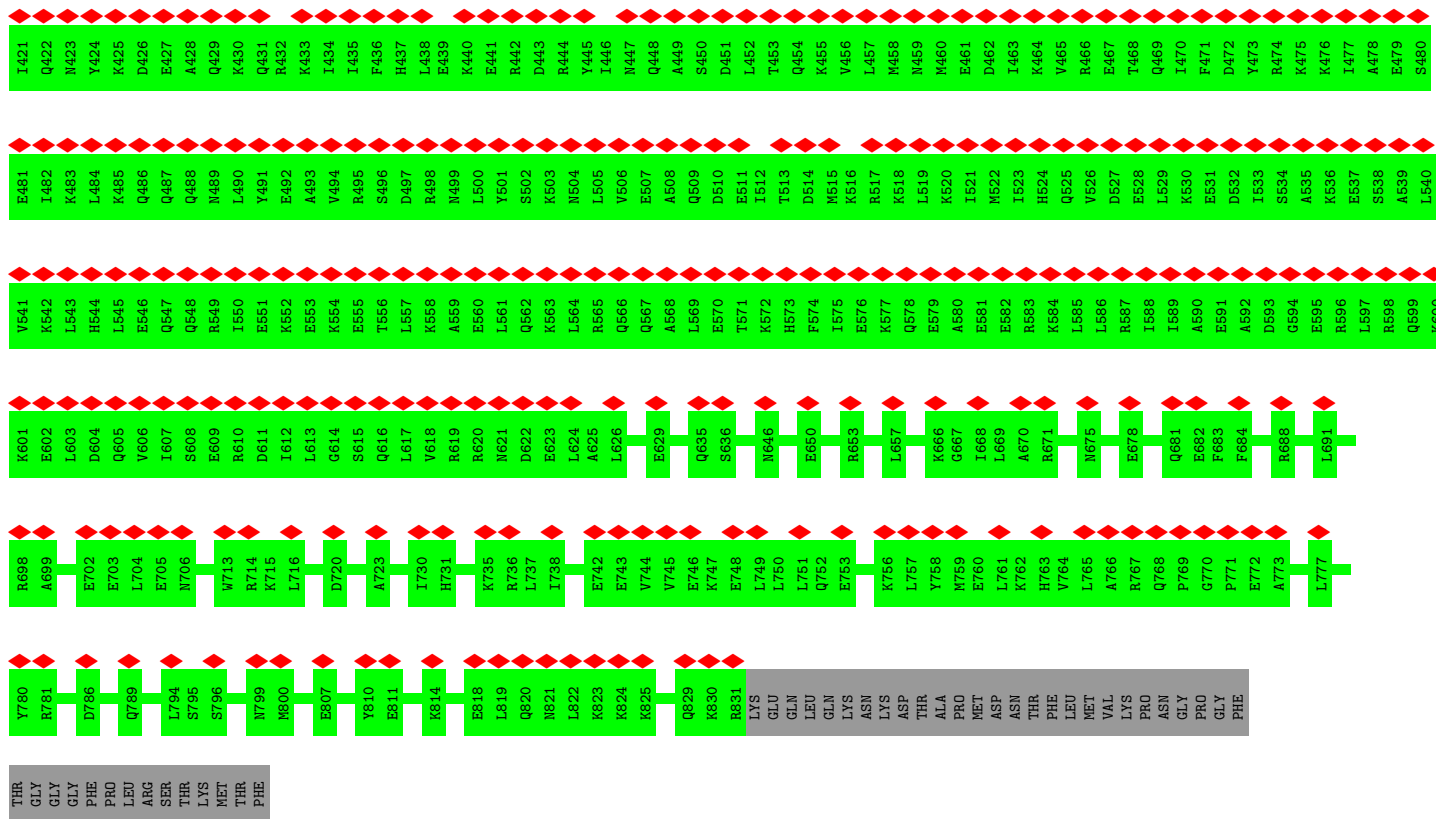

• Molecule 84: Cilia- and flagella-associated protein 73

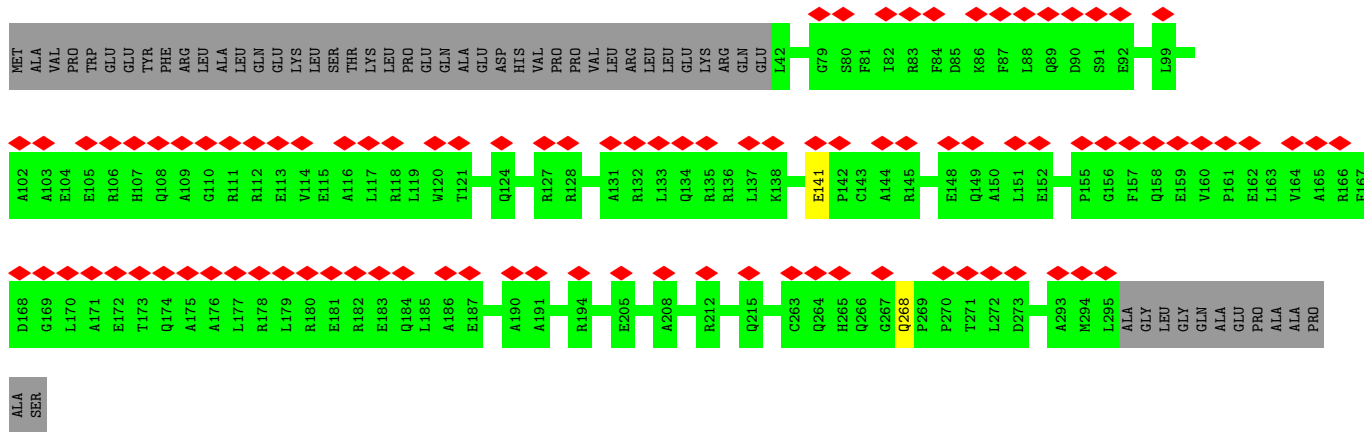
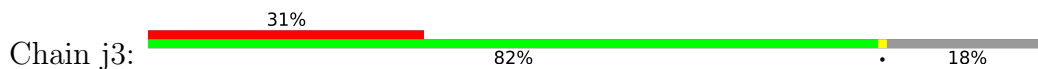

• Molecule 85: Cilia- and flagella-associated protein 100

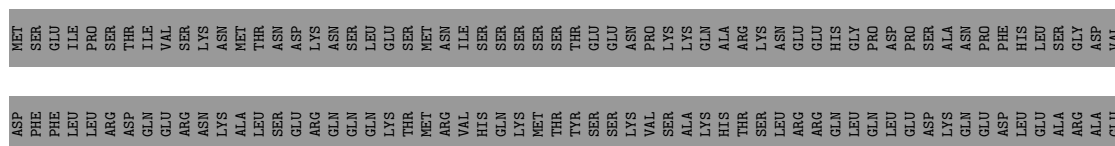

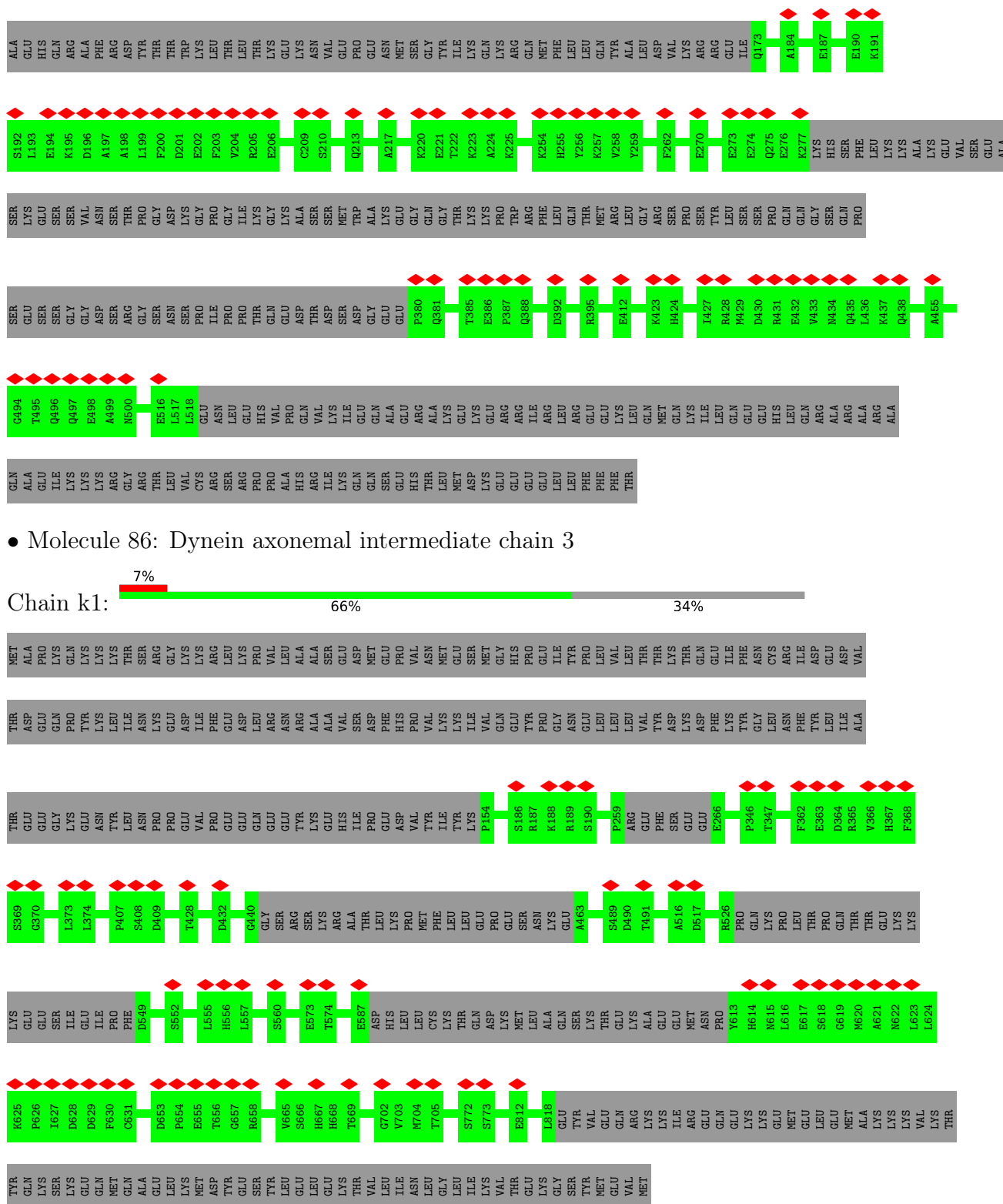

• Molecule 87: Dynein axonemal intermediate chain 4



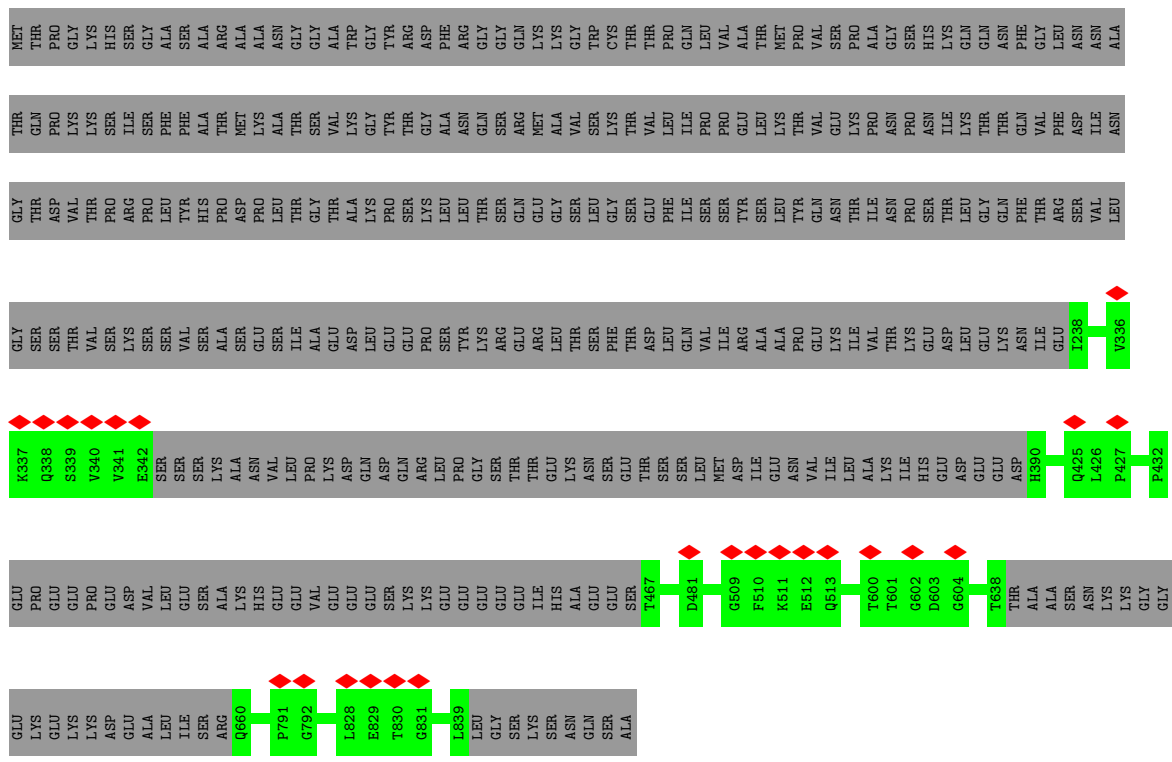

● Molecule 88: Dynein axonemal intermediate chain 7

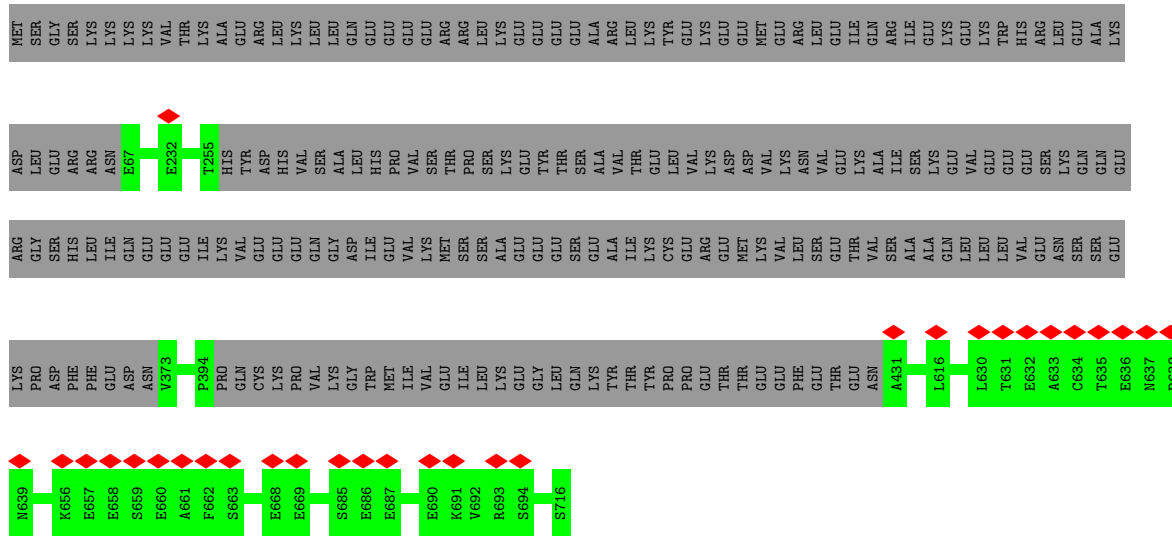

● Molecule 89: Dynein light chain roadblock-type 1

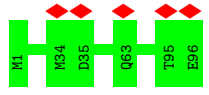

● Molecule 89: Dynein light chain roadblock-type 1

Chain m4:  100%

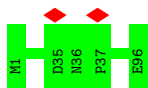

- Molecule 89: Dynein light chain roadblock-type 1

Chain o4:  100%

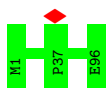

- Molecule 89: Dynein light chain roadblock-type 1

Chain q4:  8%  99%

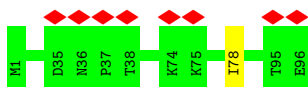

- Molecule 90: Dynein light chain roadblock-type 2

Chain k5:  100%

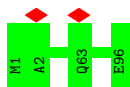

- Molecule 90: Dynein light chain roadblock-type 2

Chain m5:  8%  100%

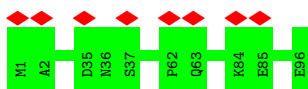

- Molecule 90: Dynein light chain roadblock-type 2

Chain o5:  9%  100%

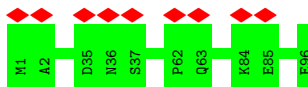

- Molecule 90: Dynein light chain roadblock-type 2

Chain q5:  18%  100%

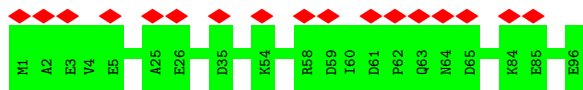

• Molecule 91: Dynein axonemal heavy chain 10

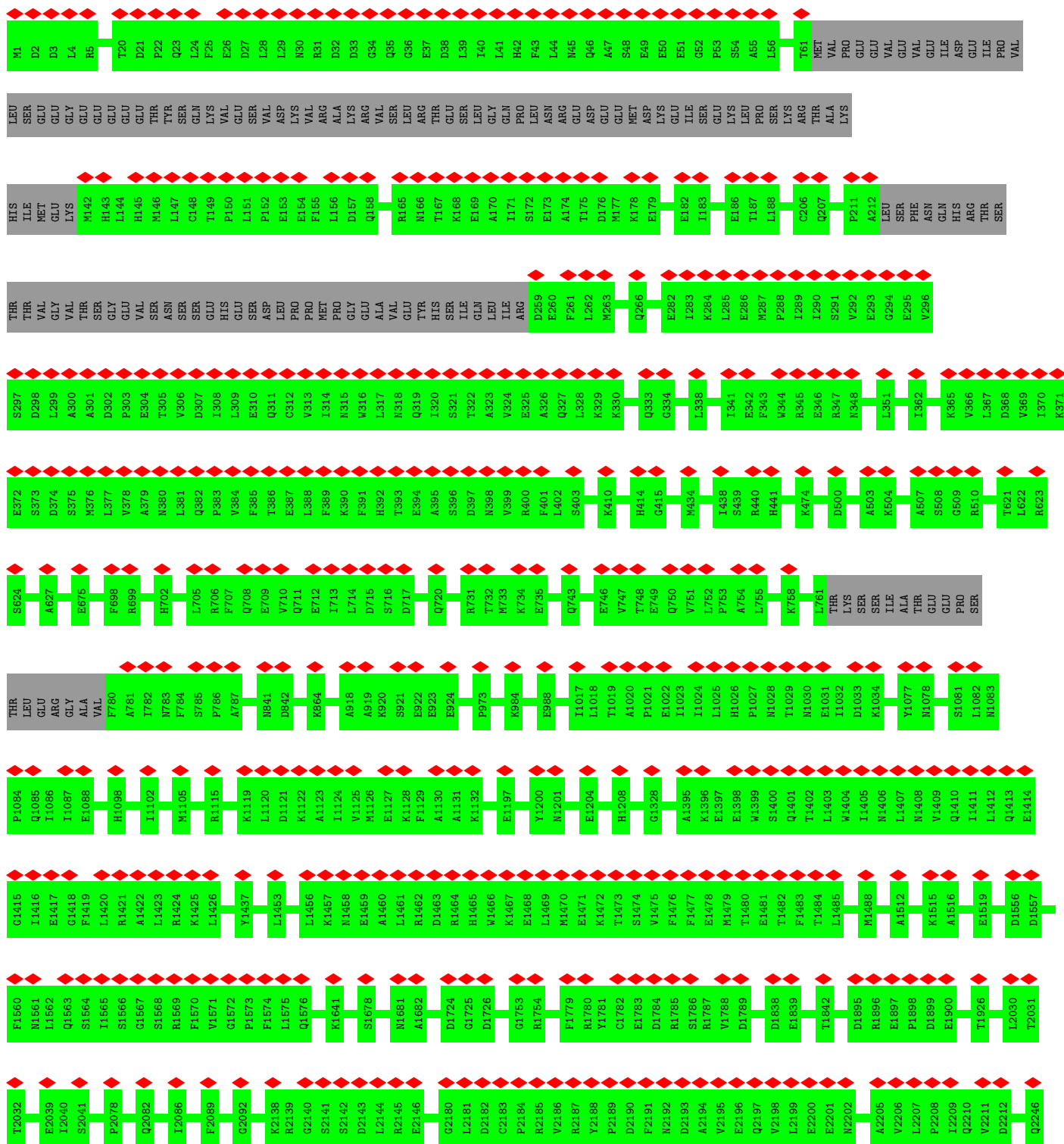

A2247	A2248	Q2248	T2249	R2250	L2251	G2252	L2253	T2254	T2255	K2256	G2272	L2273	L2274	D2275	P2276	T2277	T2278	R2279	D2280	W2281	T2282	D2283	G2284	S2287	N2288	L2289	F2290	R2291	R2292	L2293	N2294	K2295	P2296	T2297	D2298	K2299	R2300	E2301	R2302	K2303	L2328	L2329	T2330	L2331	A2332	N2333	G2334	E2335	R2336	L2337	R2338	L2339	Q2340	A2341	H2342	K2380			
V2383	N2384	Q2385	I2386	P2387	N2388	K2389	V2390	E2391	Q2392	Y2393	N2394	L2395	N2396	S2397	L2398	F2399	E2400	K2401	P2404	Y2405	E2447	G2448	E2449	I2450	E2451	D2452	L2453	D2454	E2496	G2497	W2498	A2500	N2501	E2504	I2535	H2536	A2537	P2538	E2539	K2564	S2591	E2592	E2593	T2594	N2595	E2616	A2617	E2620											
K2621	R2622	T2623	K2624	D2625	T2626	G2628	P2629	R2630	M2631	G2632	R2633	R2634	G2666	D2670	R2671	G2672	K2673	E2674	L2675	N2676	C2677	K2678	S2679	I2680	R2681	D2682	S2733	T2734	F2735	H2736	E2737	P2769	E2790	L2856	H2857	E2858	G2859	E2860	P2861	E2883	Y2884	N2885	E2886	S2887	M2888	S2939	L2946	L2947	S2948	R2949									
G2950	Y2951	S2952	E2953	N2954	S2955	F2956	R2957	E2958	D2959	L2960	K2961	S2962	L2965	K2966	L2967	I2968	E2970	N2971	K2972	A3003	L3004	F3005	S3006	E3007	E3008	E3009	K3010	E3011	S3012	L3013	L3014	S3015	Q3016	L3017	G3018	Q3019	E3020	A3021	L3022	K3023	Q3024	G3025	M3026	G3027	P3028	A3029	K3030	E3031	S3032	V3033	Q3035	Y3036	F3037	N3096					
P3097	M3098	I3099	T3155	Q3156	C3157	N3158	I3159	A3160	Q3161	C3162	K3163	R3164	L3165	D3166	G3167	G3168	L3169	D3170	K3171	L3172	K3173	E3174	A3175	T3176	I3177	Q3178	L3179	D3180	E3181	L3182	N3183	Q3184	K3185	L3186	A3187	E3188	Q3189	K3190	I3191	V3192	L3193	A3194	E3195	K3196	S3197	A3198	A3199	C3200	E3201	A3202	L3203	L3204	E3205	E3206	I3207	A3208	V3209	N3210	
T3211	A3212	V3213	A3214	E3215	E3216	K3217	K3218	K3219	L3220	A3221	E3222	E3223	K3224	A3225	M3226	E3227	I3228	E3229	E3230	Q3231	N3232	K3233	V3234	I3235	K3236	M3237	E3238	K3239	A3240	E3241	A3242	E3243	T3244	T3245	L3246	A3247	E3248	V3249	M3250	P3251	L3252	L3253	E3254	A3255	K3256	S3257	L3258	E3259	L3260	Q3261	K3262	L3263	D3264	K3265	S3266	D3267	V3268	T3269	E3270
I3271	R3272	S3273	F3274	A3275	K3276	P3277	P3278	K3279	Q3280	V3281	Q3282	T3283	V3284	C3285	E3286	I3287	I3288	L3289	I3290	M3291	K3292	G3293	Y3294	K3295	E3296	L3297	N3298	W3299	K3300	T3301	A3302	K3303	G3304	V3305	M3306	S3307	F3308	P3309	N3310	F3311	L3312	R3313	P3314	L3315	M3316	E3317	I3318	F3319	D3320	R3321	S3322	L3323	T3324	Q3325	S3326	Q3327	V3328	K3329	N3330
I3331	K3332	G3333	L3334	L3335	K3336	T3337	L3338	N3339	T3340	T3342	E3343	E3344	M3345	E3346	A3347	V3348	S3349	K3350	A3351	G3352	L3353	G3354	M3355	L3356	K3357	F3358	V3359	E3360	A3361	V3362	M3363	G3364	Y3365	C3366	D3367	F3368	F3369	K3370	E3371	I3372	K3373	P3374	K3375	R3376	E3377	K3378	V3379	A3380	R3381	L3382	R3384	N3385	Q3386	Y3387	L3388	T3389	K3390		
R3391	E3392	L3393	E3394	R3395	I3396	Q3397	N3398	E3399	L3400	A3401	A3402	L3403	Q3404	K3405	E3406	L3407	E3408	T3409	L3410	G3411	A3412	K3413	Y3414	E3415	A3416	A3417	I3418	L3419	E3420	K3421	Q3422	K3423	L3424	Q3425	E3426	E3427	A3428	E3429	I3430	M3431	E3432	R3433	R3434	L3435	I3436	A3437	A3438	D3439	K3440	L3441	I3442	S3443	G3444	L3445	G3446	E3447	E3448	N3449	I3450
R3451	W3452	L3453	N3454	L3455	L3456	D3457	E3458	L3459	K3460	H3461	R3462	K3463	V3464	K3465	L3466	L3467	V3521	S3524	R3525	S3528	Q3529	R3566	T3567	T3568	T3569	L3570	E3569	K3570	M3571	N3572	N3579	D3580	P3581	D3582	F3583	L3584	K3585	Q3586	L3587	E3588	M3589	S3590	I3591	K3592	Y3593	G3594	T3595	D3603	D3607	P3608	V3609	L3610	D3611	N3612	K3708				
M3617	I3618	K3619	V3620	S3621	Q3622	G3623	R3624	F3625	F3626	I3627	L3628	L3629	G3630	D3631	K3632	E3633	D3635	V3636	A3649	T3667	V3668	T3669	L3670	L3673	L3677	V3680	L3681	V3682	A3683	Y3684	D3685	R3686	R3687	E3688	E3691	Q3692	R3693	E3694	H3695	L3696	I3697	G3698	E3699	T3700	S3701	E3702	N3703	K3704	N3705	L3706	L3707	K3708							
D3709	L3710	E3711	D3712	S3713	L3714	L3715	R3716	E3717	L3718	A3719	T3720	S3721	T3722	G3723	N3724	M3725	L3726	D3727	N3728	V3729	D3730	L3731	V3732	H3733	T3734	L3735	E3736	F3737	T3738	K3739	S3740	K3741	A3742	T3743	E3744	V3745	E3747	K3748	L3749	K3750	L3751	A3752	E3753	K3754	G3765	R3766	P3767	P3768	A3769	R3770	R3771	R3772	G3773	N3774	F3777				
L3794	L3795	A3796	F3797	L3798	E3799	V3800	F3801	L3802	L3803	S3804	L3805	K3806	S3808	L3809	P3810	R3811	S3812	L3813	L3814	M3815	K3816	L3817	L3818	R3819	N3820	I3821	R3822	D3823	T3824	L3825	S3828	E3857	G3858	R3859	K3882	F3883	C3884	A3885	K3886	D3904	N3905	F3906	G3907	Q3908	D3911	D3912	V3913	E3914	N3915	N3916	Q3917	T3918	V3919						



● Molecule 92: Dynein axonemal heavy chain 2

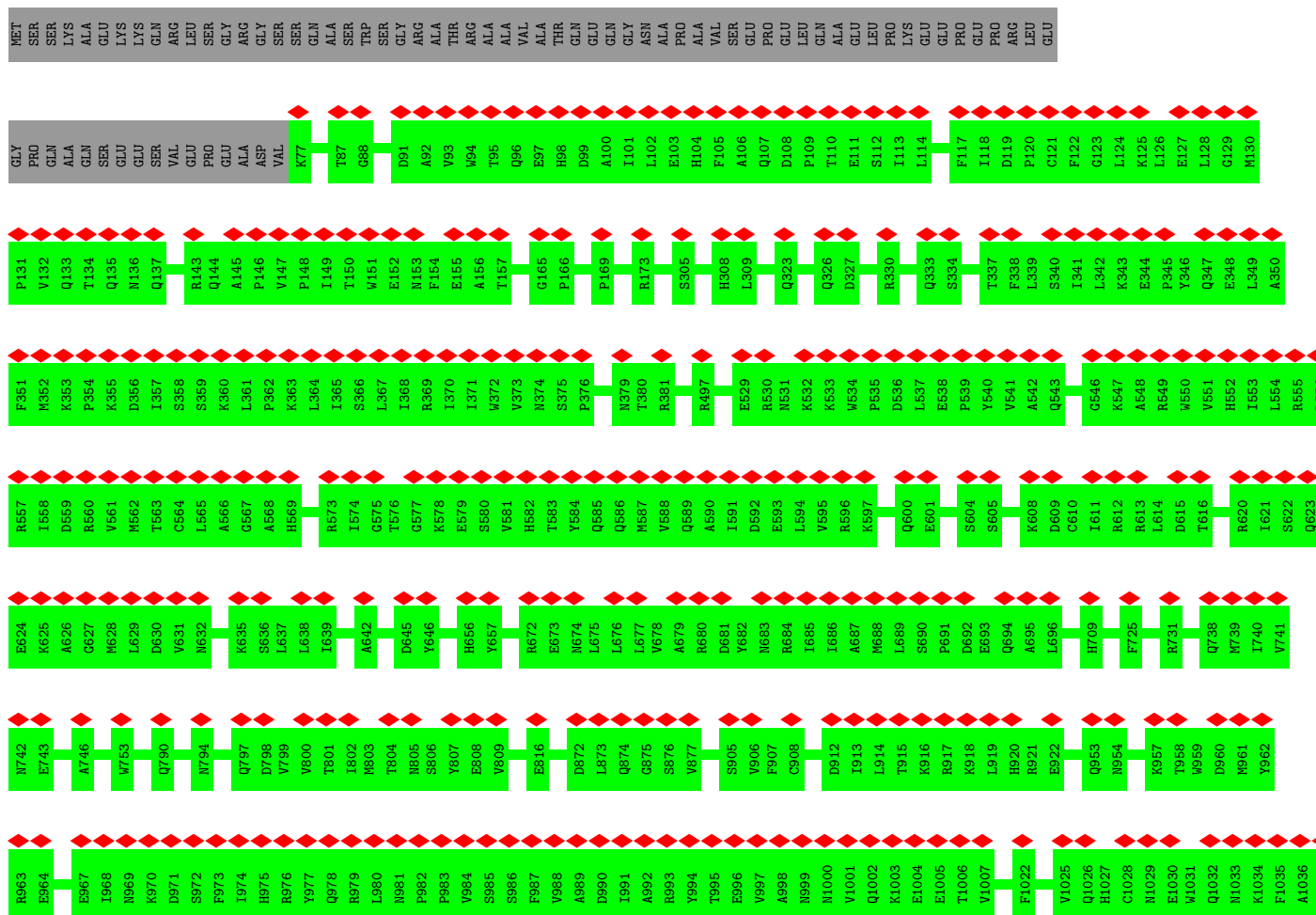

L1038	L1039	R1040	E1041	M1042	A1043	A1044	G1045	R1046	L1047	L1048	E1049	L1050	H1051	T1052	Y1053	L1054	K1055	E1056	M1057	A1058	E1059	K1060	E1069	G1070	Y1073	S1074	L1075	Q1076	L1077	Y1078	D1079	A1080	L1081	K1082	H1083	D1084	L1085	A1086	M1087	V1088	E1089	T1090	Q1091	I1092	P1093	P1094	I1095	H1096	E1097	Q1098	F1099	A1100	I1101	L1102	E1103	K1104	Y1105			
E1106	V1107	P1108	V1109	D1110	D1111	S1112	V1113	L1114	E1115	M1116	L1117	D1118	S1119	L1120	N1121	E1122	E1123	W1124	V1125	V1126	F1127	Q1128	Q1129	T1130	L1131	L1132	D1133	S1134	K1135	Q1136	M1137	L1138	K1139	H1140	H1141	K1142	E1143	K1144	F1145	K1146	T1147	G1148	L1149	I1150	H1151	S1152	A1153	D1154	D1155	F1156	K1157	K1158	K1159	A1160	H1161	T1162	L1163	L1164	E1165	
D1166	F1167	E1168	F1169	K1170	G1171	H1172	L1173	T1174	S1175	M1176	V1177	G1178	Y1179	M1180	S1181	A1182	L1183	D1184	Q1185	I1186	T1187	Q1188	V1189	R1190	A1191	M1192	L1193	M1194	A1195	I1212	E1213	D1228	Q1231	Q1232	I1233	W1234	E1235	L1236	A1237	M1238	D1239	W1240	E1241	E1242	M1243	W1244	M1245	E1246	W1247	K1248	T1249	G1250	R1251	F1252	L1253	I1254				
L1255	Q1256	T1257	E1258	L1259	M1260	E1261	T1262	T1263	L1264	H1265	G1266	L1267	F1268	R1269	R1270	L1271	R1281	M1282	W1283	E1284	I1285	V1288	T1289	K1292	I1293	E1294	Q1295	F1296	K1297	R1298	T1299	M1300	P1301	L1302	I1303	S1304	L1305	L1306	R1307	M1308	P1309	A1310	L1311	R1312	E1313	W1314	M1315	W1316	D1317	Q1318	V1319	R1320	R1321	E1322	L1323	Q1324				
R1325	E1326	F1327	D1328	Q1329	E1330	S1331	E1332	S1333	F1334	T1335	L1336	Q1337	Q1338	I1339	V1340	E1341	L1342	G1343	M1344	D1345	Q1346	H1347	V1348	E1349	K1350	I1351	E1352	E1353	I1354	S1355	A1356	S1357	A1358	T1359	T1359	K1360	L1361	E1362	A1363	I1364	E1365	V1366	A1367	L1368	Q1369	M1370	I1371	A1372	K1373	T1374	W1375	D1376	V1377	T1378	Q1379	L1380	D1381	I1382	V1383	P1384
Y1385	K1386	D1387	K1388	H1389	H1390	H1391	R1392	L1393	R1394	G1395	T1396	E1397	E1398	V1399	F1400	Q1401	A1402	L1403	E1404	D1405	N1406	Q1407	V1408	A1409	L1410	S1411	T1412	M1413	K1414	A1415	S1416	R1417	F1418	V1419	K1420	A1421	F1422	E1423	K1424	D1425	V1426	D1427	H1428	W1429	M1430	R1431	A1432	L1433	S1434	L1435	I1436	L1437	E1438	V1439	I1440	M1441	E1442	L1443	I1444	
T1445	V1446	Q1447	R1448	W1450	M1451	Y1452	L1453	E1454	M1455	I1456	F1457	L1458	G1459	E1460	D1461	I1462	R1463	K1464	Q1465	L1466	P1467	M1468	E1469	I1470	S1471	L1472	F1473	D1474	Q1475	V1476	M1477	S1478	M1479	W1480	K1481	A1482	I1483	M1484	D1485	D1486	M1487	M1488	K1489	L1490	M1491	M1492	E1493	A1494	R1495	S1496	P1497	L1497	H1498	H1499	P1500	G1501	L1502	L1503	D1504	
T1505	L1506	I1507	E1508	M1509	T1511	I1512	L1513	E1514	D1515	I1516	Q1517	K1518	S1519	L1520	D1521	M1522	Y1523	L1524	E1525	T1526	K1527	R1528	H1529	I1530	F1531	P1532	R1533	F1534	Y1535	F1536	L1537	S1538	M1539	D1540	D1541	L1542	L1543	E1544	I1545	I1546	G1547	Q1548	S1549	M1551	P1552	E1553	A1554	V1555	Q1556	P1557	L1557	H1558	L1559	K1560	M1561	C1562	F1563	D1564		
M1565	I1566	K1567	L1568	L1569	R1570	I1571	Q1572	V1573	G1575	G1576	P1577	S1578	S1579	K1580	W1581	E1582	A1583	V1584	G1585	M1586	F1587	S1588	G1589	D1590	G1591	E1592	Y1593	I1594	D1595	F1596	L1597	H1598	S1599	V1600	F1601	L1602	E1603	G1604	P1605	V1606	E1607	S1608	W1609	L1610	G1611	D1612	V1613	Q1614	T1616	M1617	V1618	V1619	T1620	L1621	R1622	D1623	L1624			
L1625	R1626	M1627	C1628	H1629	L1630	A1631	L1632	L1633	K1634	F1635	L1636	M1637	K1638	R1639	D1640	M1641	V1642	V1643	K1644	E1645	W1646	A1647	Q1648	V1649	V1650	V1651	I1652	T1653	A1654	S1655	S1688	I1689	L1690	M1691	K1692	Y1693	S1694	E1695	A1696	I1697	R1698	G1699	M1700	L1701	T1702	K1703	I1704	M1705	R1706	L1707	K1708	I1709	V1710	A1711	L1712	V1713	T1714	I1715		
E1716	I1717	R1720	W1747	E1748	K1749	D1750	L1751	D1752	D1753	Y1765	M1766	Y1767	E1768	Y1769	L1770	G1771	M1772	S1773	G1774	R1775	L1776	V1777	I1778	G1803	P1804	A1805	G1806	T1807	G1808	K1809	T1810	E1811	T1812	Y1813	K1814	D1815	L1816	G1817	K1818	G1821	I1822	Y1823	W1824	I1825	V1826	V1827	N1828	C1829	S1830	E1831	G1832	L1833	D1834	Y1835						
K1836	S1837	M1838	G1839	R1840	M1841	Y1842	S1843	G1844	Q1847	T1848	C1853	F1854	D1855	E1856	F1857	M1858	R1859	I1860	M1861	I1862	E1863	V1864	L1865	S1866	V1867	H1870	L1873	C1874	S1877	A1878	L1879	A1880	A1881	G1882	L1883	T1884	H1885	D1886	H1887	F1888	D1889	G1890	F1891	E1892	I1893	M1894	L1895	V1896	M1897	F1902	I1903	T1904	M1905							
M1906	P1907	G1908	Y1909	A1910	G1911	R1912	V1929	V1930	P1931	D1932	S1933	T1934	L1935	I1936	A1937	E1938	I1939	L1940	F1942	G1943	E1944	G1945	F1946	G1947	M1948	K1950	V1956	Y1957	Y1960	L1979	S1961	R1969	Q1970	D1971	Y1972	H1973	D1974	F1975	F1976	L1977	R1978	A1979	L1980	T1981	S1982	L1983	L1984	R1985	Y1986	A1987	G1988	T1989	K1990	R1991						

R1992	L1993	Q1994	P1995	D1996	L1997	T1998	D1999	V2002	L2005	S2006	H2007	R2008	D2009	M2010	N2011	I2012	A2013	R2014	L2015	T2016	S2017	A2020	R2033	I2034	E2035	L2036	F2037	V2038	I2039	D2040	Y2041	G2042	R2043	E2044	R2045	E2046	T2047	V2048	E2049	Q2050	E2051	I2052	R2053	D2054	G2055	G2056	L2057	Q2058	S2059	T2060	F2061	F2062	T2063	L2064	T2065					
K2066	V2067	F2068	Q2069	L2070	Y2071	E2072	T2073	K2074	N2075	S2076	R2077	H2078	S2079	C2085	R2095	I2096	L2097	Q2098	A2099	S2100	L2101	S2102	S2103	L2104	C2105	R2106	A2107	G2108	D2109	P2110	N2111	F2112	N2113	I2114	V2115	R2116	E2117	E2133	Y2134	L2135	L2136	S2137	T2138	N2139	E2140	T2141	T2142	D2143	A2155	D2156	E2157	K2158	P2159	D2160	E2161					
K2162	W2163	T2172	E2176	N2179	S2180	W2181	M2182	D2183	A2248	D2184	K2185	M2186	V2187	L2190	I2191	N2192	G2193	E2194	R2195	I2196	L2197	M2198	P2199	E2200	Q2201	V2202	S2203	D2210	L2211	A2212	M2213	A2214	S2215	P2216	A2217	V2218	T2219	S2220	R2221	C2222	G2223	M2224	V2225	T2226	Y2227	D2228	Y2229	A2230	D2231	L2232	G2233	W2234	K2235	P2236	Y2237					
V2238	Q2239	W2241	L2242	E2243	K2244	R2245	F2246	K2247	A2248	E2249	V2250	E2251	F2252	L2253	Q2254	R2255	M2256	F2257	E2258	K2259	L2260	I2261	M2262	K2263	M2264	L2265	A2266	K2268	K2269	D2270	N2271	C2272	K2273	F2279	E2280	Y2281	S2282	G2283	I2284	L2287	C2288	Y2291	L2294	A2295	T2296	P2297	M2298	G2300	V2301	M2302	P2303	A2304								
D2305	Q2306	E2307	N2308	Y2309	V2310	T2311	M2312	V2313	E2314	M2315	T2316	F2317	V2318	F2319	S2320	M2321	I2322	V2325	C2326	E2332	Q2333	R2334	K2335	R2336	I2337	D2338	S2339	Y2340	L2341	R2342	E2343	I2344	E2345	G2346	S2347	V2359	D2360	P2361	K2362	R2363	S2364	S2365	W2366	T2367	S2368	F2369	E2370	L2373	P2374	K2375	S2376	W2377	R2378	Y2379	P2380					
F2381	W2382	S2435	S2436	Q2437	K2464	R2465	T2466	K2467	G2468	F2473	G2474	G2475	F2468	K2559	S2560	Q2561	I2562	I2563	G2567	T2568	M2569	I2570	N2571	Q2572	K2573	L2574	Q2575	R2576	F2577	E2578	E2579	E2580	V2581	K2582	P2583	I2584	G2585	N2586	V2587	V2588	T2589	E2590	A2591	L2592	D2593	D2594	W2595	H2596	H2597	T2598	V2599	V2600	Q2601							
R2602	F2603	L2604	P2605	T2606	M2630	K2631	D2632	F2633	H2634	D2635	T2636	K2637	S2638	S2639	I2640	R2642	L2643	W2644	I2645	C2646	F2649	S2653	D2658	A2659	A2660	T2662	E2663	F2665	M2666	G2667	I2668	L2669	S2670	D2671	K2672	L2673	G2674	V2675	F2676	F2677	D2678	L2679	T2680	F2681	H2682	H2683	C2685	P2686	S2687	R2688	R2689									
P2690	P2691	I2692	E2704	D2705	L2706	D2708	L2709	T2710	V2711	L2712	K2713	T2714	E2717	T2718	M2721	Q2733	L2734	V2735	R2738	T2769	K2790	H2791	Y2792	A2793	R2794	Q2795	E2796	D2799	K2802	R2803	R2806	Q2807	A2808	G2809	V2810	E2811	L2812	K2813	Y2846	K2847	P2848	D2849	E2850	F2851	R2852	E2853	I2854	Q2855												
S2856	H2857	I2858	I2859	D2860	Q2861	A2862	R2863	V2864	E2865	Q2866	V2867	R2868	E2869	S2870	S2871	D2872	S2873	L2874	F2875	A2876	Y2877	L2878	E2881	P2922	Q2923	E2924	A2925	L2926	L2927	E2928	V2929	E2931	A2930	K2932	C2933	L2934	I2935	Q2936	V2937	D2938	L2939	G2940	T2941	Q2942	E2943	N2944	I2945	H2946	R2947	K2948	V2949	A2950	Q2951	I2952	F2953	V2954	T2955			
M2956	H2957	W2958	S2959	V2960	A2961	Q2962	Y2963	S2964	Q2965	K2966	L2969	E2970	L2971	T2980	L2983	E2984	L2985	L2986	S2987	G2988	Y2989	K2990	K2991	L2992	L2993	G2994	E2995	K2996	R2997	Q2998	L3000	L3001	A3002	Q3003	A3004	N3005	K3006	R3007	R3008	G3010	L3011	F3012	K3013	I3014	D3015	E3016	T3017	R3018	E3019	K3020	V3021	Q3022	V3023	M3024						
S3025	L3026	E3027	L3028	E3029	D3030	A3031	K3032	K3033	K3034	V3035	A3036	E3037	F3038	Q3039	K3040	Q3041	C3042	E3043	E3044	Y3045	L3046	V3047	I3048	V3049	Q3050	Q3051	Q3052	K3053	R3054	E3055	A3056	D3057	E3058	Q3059	Q3060	K3061	A3062	V3063	T3064	A3065	N3066	S3067	E3068	K3069	L3070	I3071	A3072	V3073	E3074	S3075	K3076	C3077	Q3078	A3079	L3080	A3081	Q3082	N3083	A3084	
Q3085	K3086	D3087	L3088	E3089	E3090	A3091	L3092	P3093	K3153	K3154	S3155	E3096	E3097	A3098	M3099	R3100	A3101	L3102	E3103	S3104	L3105	N3106	K3107	K3108	L3109	I3110	G3111	E3112	L3113	K3114	S3115	Y3116	K3117	R3118	P3119	P3120	A3121	Q3122	V3123	E3124	L3125	V3126	M3127	K3128	A3129	V3130	M3131	I3132	L3133	R3134	G3135	N3136	E3137	P3138	W3139	W3140	A3141	E3142	A3143	K3144
R3145	Q3146	L3147	G3148	E3149	Q3150	N3151	F3152	K3153	K3154	S3155	L3156	L3157	N3158	F3159	D3160	K3161	R3162	N3163	I3164	S3165	D3166	K3167	V3168	L3169	K3170	K3171	I3172	G3173	A3174	Y3175	C3176	A3177	K3178	P3179	D3180	F3181	Q3182	F3183	D3184	I3185	G3187	K3188	S3189	V3190	L3191	A3192	A3193	K3194	S3195	L3196	C3197	N3198	W3199	V3200	R3201	A3202	K3203	E3204		

E4082	P3950	L3750	C6610	E3550	R3387	M3270	L3265	R3206	L3205
T4083	K3951	M3751	A3611	L3551	G3388	V3475	R3266	R3266	Y3206
Y4084	G3952	N3752	Q3612	E3552	M3389	E3476	K3267	K3267	G3207
F4085	R3879	S3753	R3613	D3553	N3390	Y3477	K3268	K3268	R3208
L4086	L3880	F3754	A3614	E3554	R3391	N3478	S3269	S3269	L3209
P4087	F3881	E3755	R3615	L3555	K3392	T3479	E3270	E3270	Y3210
K4088	R3882	Q3756	I3616	L3556	A3399	N3480	E3271	E3271	R3211
R4089	E3883	Y3757	L3617	R3557	Q3400	F3481	M3272	M3272	V3212
G4090	P3884	P3758	F3618	R3558	Q3401	R3482	E3273	E3273	V3213
S4091	R3889	R3759	F3619	L3559	A3401	F3483	L3274	L3274	E3214
A4092	V3821	D3760	R3620	N3560	L3402	Y3484	K3275	K3275	P3215
M4093	L3822	K3761	L3621	E3561	K3403	A3500	L3276	L3276	K3216
N4094	N3823	H3762	N3622	S3562	M3404	K3501	E3277	E3277	R3217
H4095	K3824	L3763	T3623	T3563	I3405	T3502	R3278	R3278	I3218
R4096	K3825	W3764	G3564	G3564	I3406	F3507	A3279	A3279	R3219
V4097	S3826	Y3765	S3565	S3565	K3407	A3508	G3280	G3280	M3220
F3892	V3827	T3766	L3566	L3566	E3409	R3509	M3281	M3281	N3221
G3888	R3828	A3768	D3568	D3568	K3408	K3510	L3282	L3282	A3223
V3889	L3829	A3769	R3569	R3569	G3410	V3509	S3283	S3283	L3224
A3894	D3830	A3770	A3637	D3569	G3411	K3511	S3284	S3284	G3225
S3899	S3831	F3770	F3633	V3570	E3409	R3511	G3285	G3285	A3226
L3900	L3832	E3771	L3634	I3571	E3409	E3511	L3286	L3286	Q3226
S3901	P3833	K3772	L3635	L3572	G3411	Q3512	A3287	A3287	L3227
N3902	R3834	A3773	S3640	L3573	L3414	G3513	R3288	R3288	R3228
K3903	S3835	M3774	L3641	V3573	K3415	L3514	S3289	S3289	K3229
P3904	P3836	W3775	N3574	N3574	I3416	E3515	E3289	E3289	K3230
N3905	L3837	L3776	I3643	T3575	S9422	A3516	K3290	K3290	R3231
L3906	P3837	F3776	L3644	L3576	D3423	Q3517	A3291	A3291	Q3231
R3907	V3838	G3777	S3645	H3577	Y3424	R3518	R3292	R3292	A3232
K3908	F3839	E3778	I3646	R3578	L3425	L3519	W3293	W3293	A3233
L3909	D3845	W3779	D3647	S3579	R3426	G3520	E3294	E3294	L3234
L3909	P3847	E3780	K3648	K3580	I3427	I3521	E3295	E3295	A3235
V3910	T3848	N3781	S3649	L3581	L3428	V3522	T3296	T3296	E3236
E3911	R3849	A3782	H3650	T3582	E3429	R3523	S3297	S3297	A3237
Q3912	S3849	C3783	R3651	S3582	H3430	R3524	Q3298	Q3298	Q3238
L3913	A3850	N3784	S3652	T3584	R3431	K3525	G3299	G3299	E3239
Q3914	L3851	E3785	N3653	E3585	I3432	K3526	L3300	L3300	K3240
V3915	L3852	M3786	K3654	R3586	H3433	R3527	E3301	E3301	L3241
E3916	Q3853	Q3787	L3655	V3587	F3434	R3528	S3302	S3302	R3242
D3917	L3854	R3788	E3656	E3588	G3435	R3529	D3303	D3303	E3243
P3918	A3855	M3789	R3657	Q3589	Y3436	L3530	L3304	L3304	V3244
H3919	E3856	K3790	L3590	L3590	F3437	E3532	G3305	G3305	A3245
P3920	H3857	I3791	S3591	S3591	P3437	E3532	Y3306	Y3306	A3246
S3921	K3858	V3792	D3660	T3592	V3438	Q3533	L3307	L3307	K3247
F3922	G3859	R3793	Y3661	S3593	M9456	K3534	L3308	L3308	L3248
R3923	A3860	S3794	L3662	E3594	A3460	R3535	G3309	G3309	E3249
L3924	K3861	L3795	N3663	R3594	R3461	S3536	D3310	D3310	M3250
W3925	Q3862	R3796	D3664	T3596	I3462	L3537	C3311	C3311	L3251
L3926	R3863	Q3797	Y3665	E3597	G3463	S3374	L3312	L3312	K3252
S3927	F3864	D3798	H3666	R3598	G3464	D3375	L3313	L3313	K3253
D3933	H3865	E3740	T3667	L3598	R3465	L3539	A3314	A3314	Q3254
I3936	A3866	L3741	Y3668	T3600	L3466	N3540	A3315	A3315	Y3255
K3936	L3867	D3742	A3669	D3601	L3467	I3541	A3316	A3316	D3256
S3937	S3868	K3743	R3670	L3602	M9468	A3542	F3317	F3317	E3257
I3938	L3869	L3744	Y3671	L3603	R3469	A3543	R3318	R3318	K3258
L3939	G3870	T3745	R3672	R3604	I3470	G3544	S3319	S3319	L3259
Q3940	Q3871	T3746	R3673	E3605	I3470	K3545	S3320	S3320	A3260
V3941	G3872	I3746	Y3674	E3606	G3471	R3546	M3321	M3321	K3261
I3809	Q3873	H3748	T3675	Y3607	D3472	K3547	L3325	L3325	E3263
A3874	A3874	G3749	R3676	R3608	K3473	K3549	T3326	T3326	E3264
P3875	T3810			P3609					

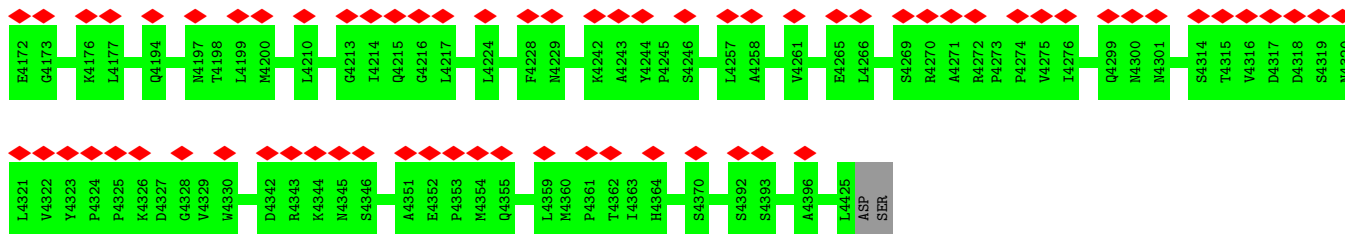

• Molecule 93: Dynein light chain Tctex-type protein 2B

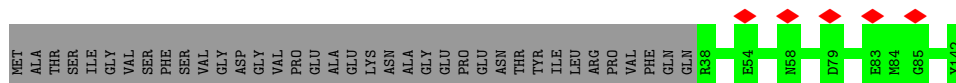
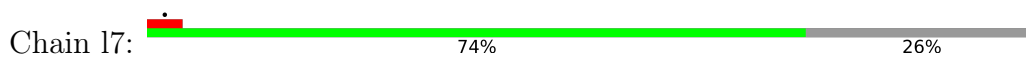

• Molecule 93: Dynein light chain Tctex-type protein 2B

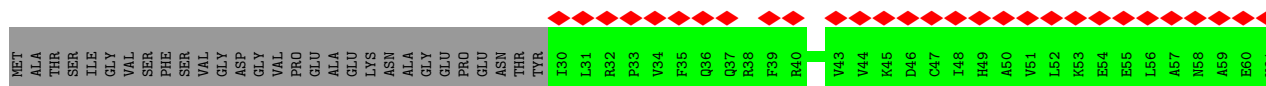
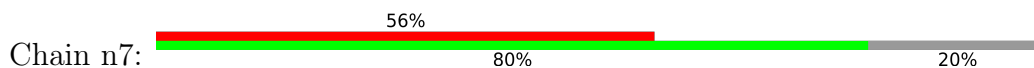

• Molecule 93: Dynein light chain Tctex-type protein 2B

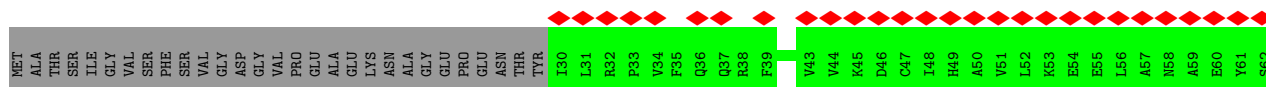
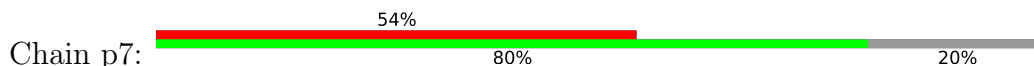

• Molecule 93: Dynein light chain Tctex-type protein 2B

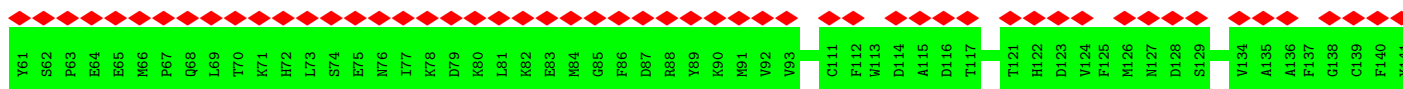
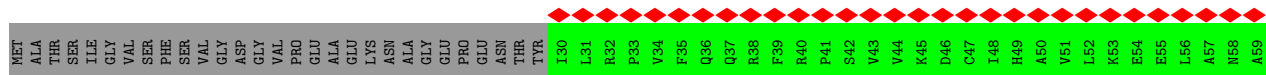
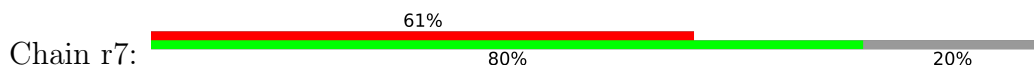

Y142

• Molecule 94: Dynein light chain Tctex-type 1

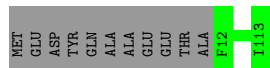
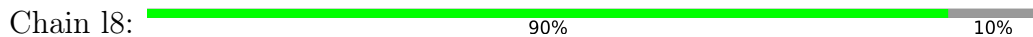

• Molecule 94: Dynein light chain Tctex-type 1

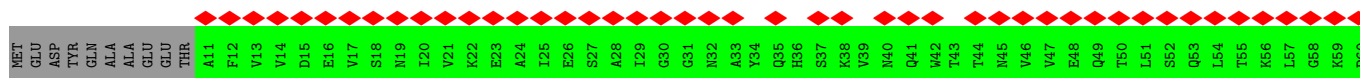
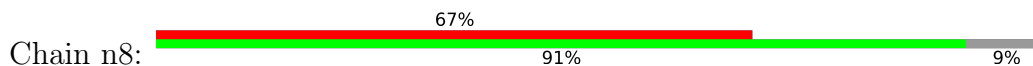

• Molecule 94: Dynein light chain Tctex-type 1

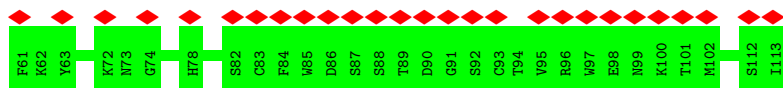
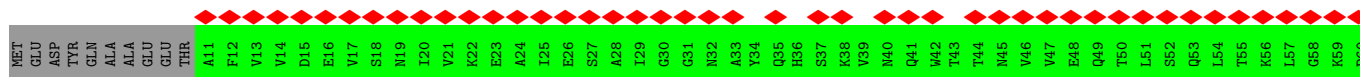
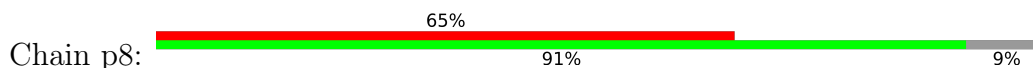

• Molecule 94: Dynein light chain Tctex-type 1

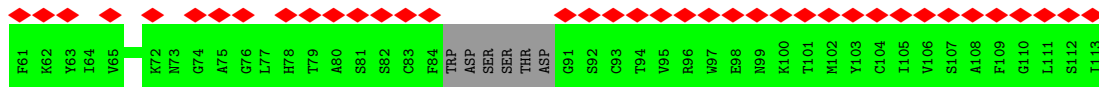
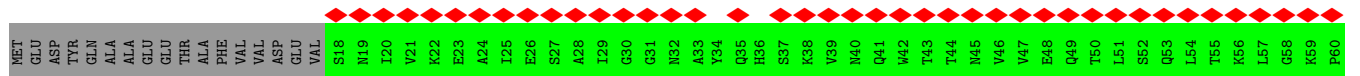
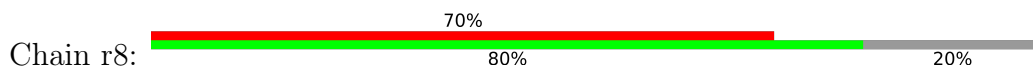

• Molecule 95: Calaxin

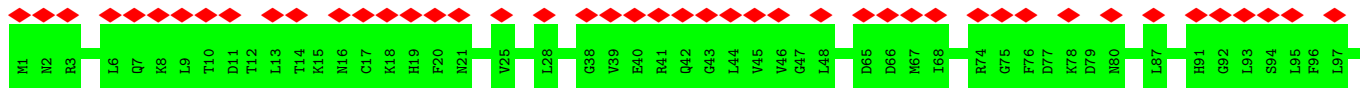
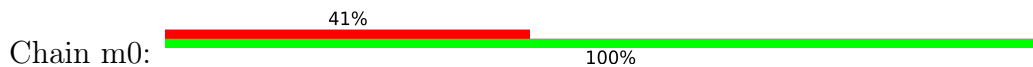

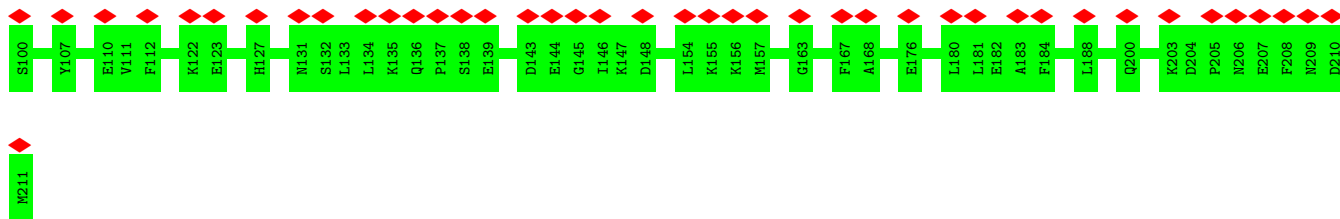

• Molecule 95: Calaxin

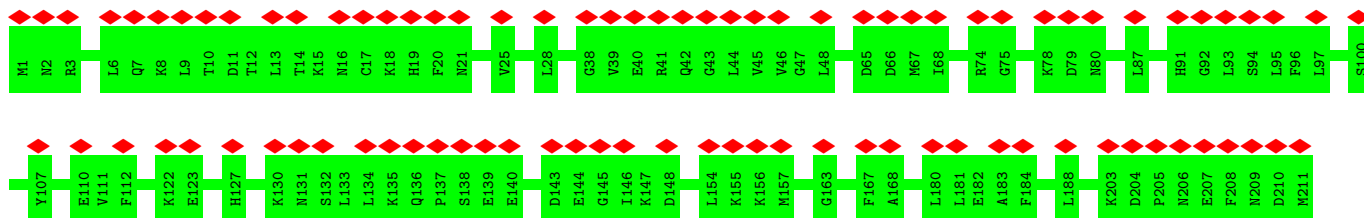
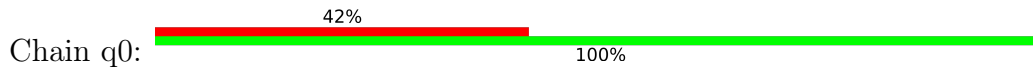

• Molecule 95: Calaxin

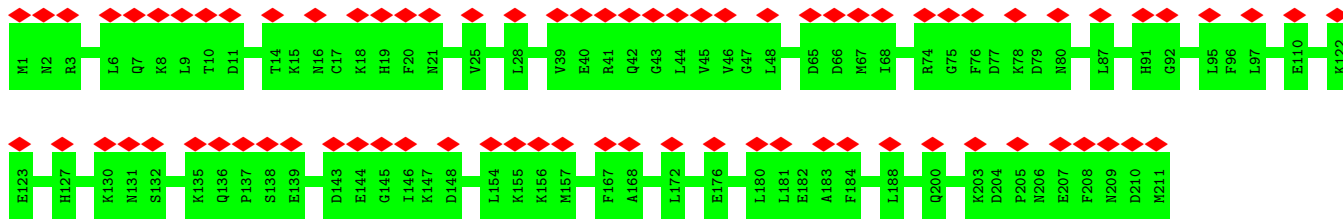

• Molecule 95: Calaxin

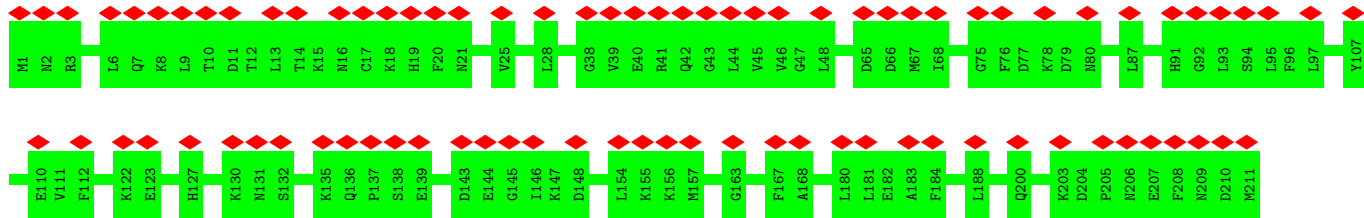
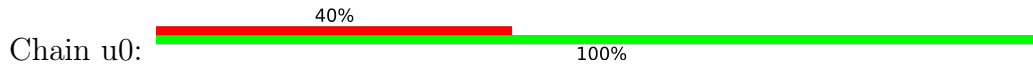

• Molecule 96: Dynein axonemal intermediate chain 1

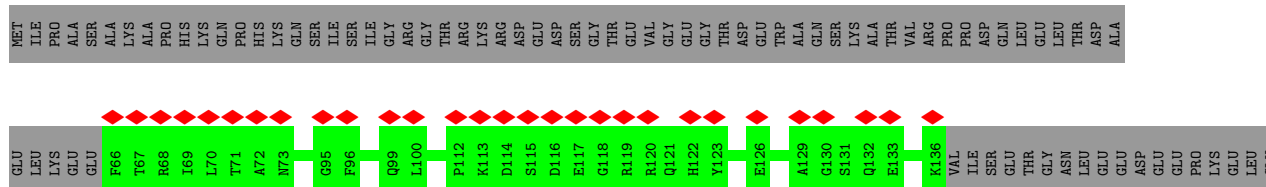
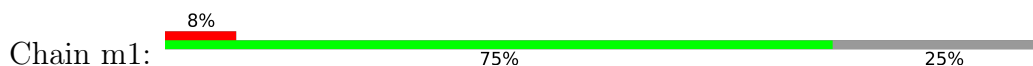

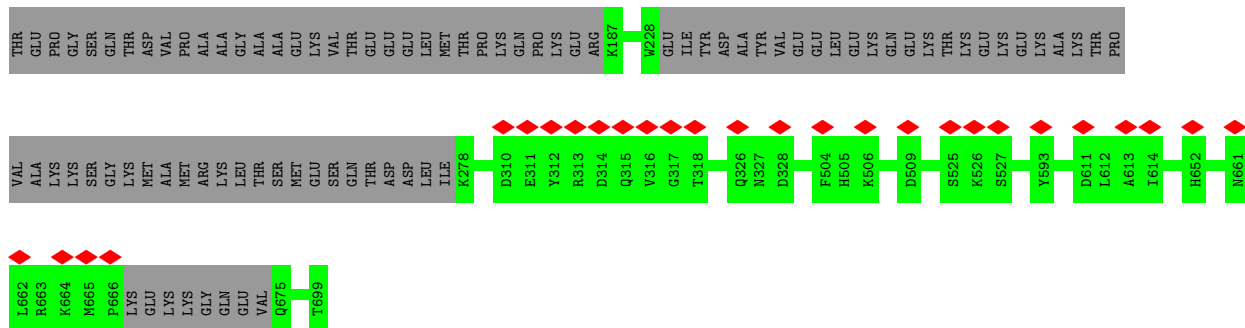

• Molecule 96: Dynein axonemal intermediate chain 1

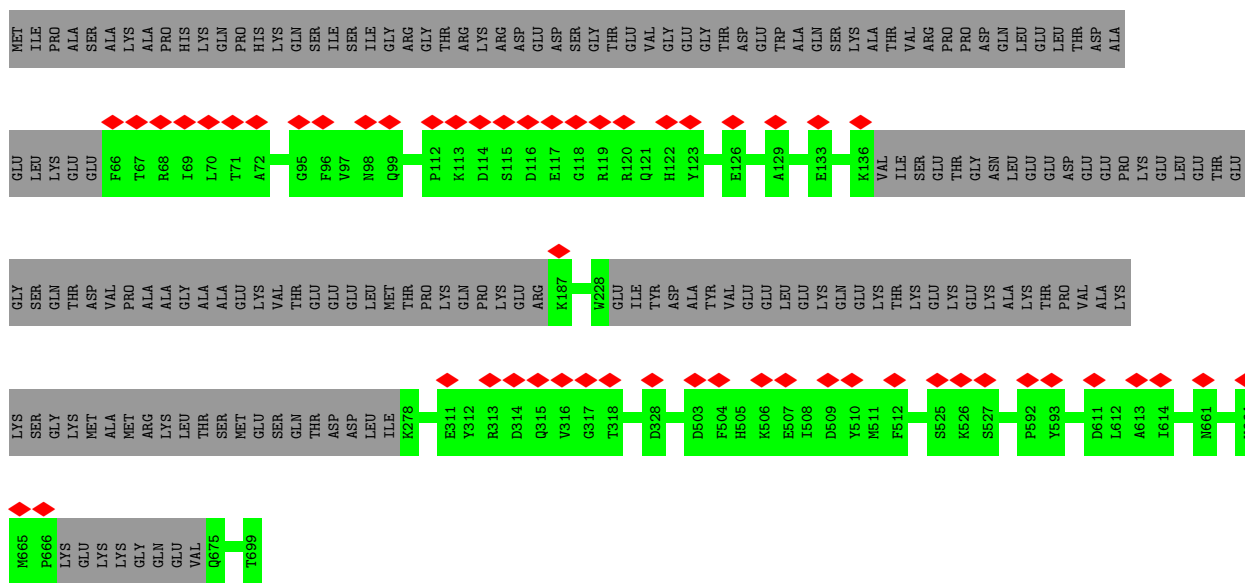
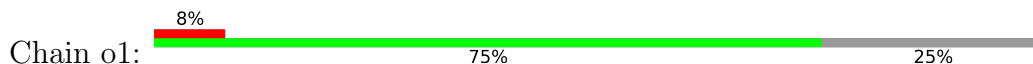

• Molecule 96: Dynein axonemal intermediate chain 1

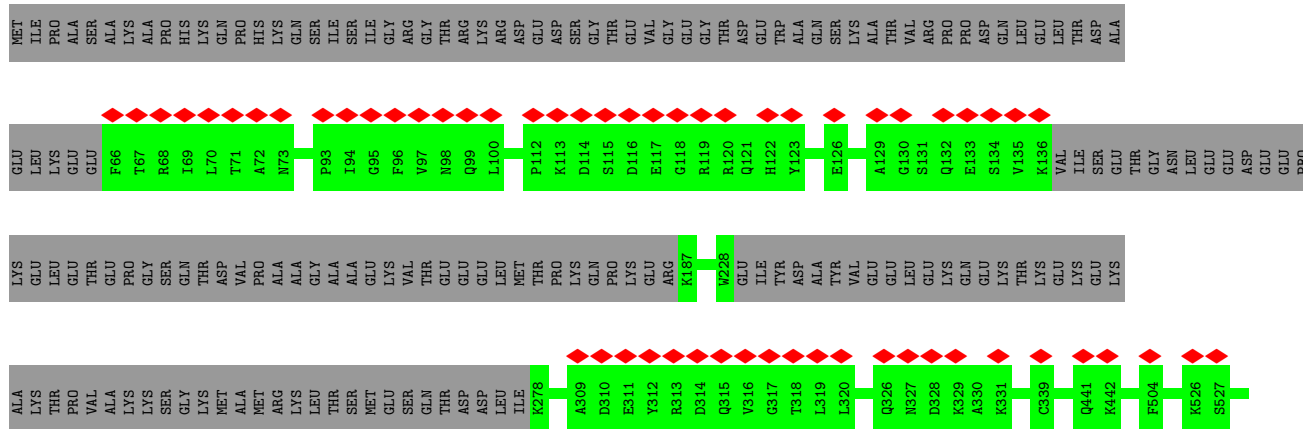

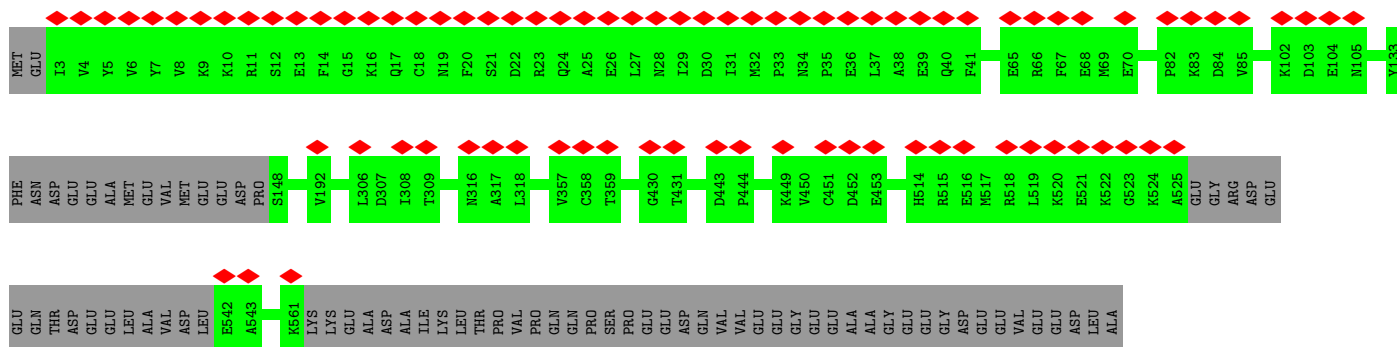

• Molecule 97: Dynein axonemal intermediate chain 2

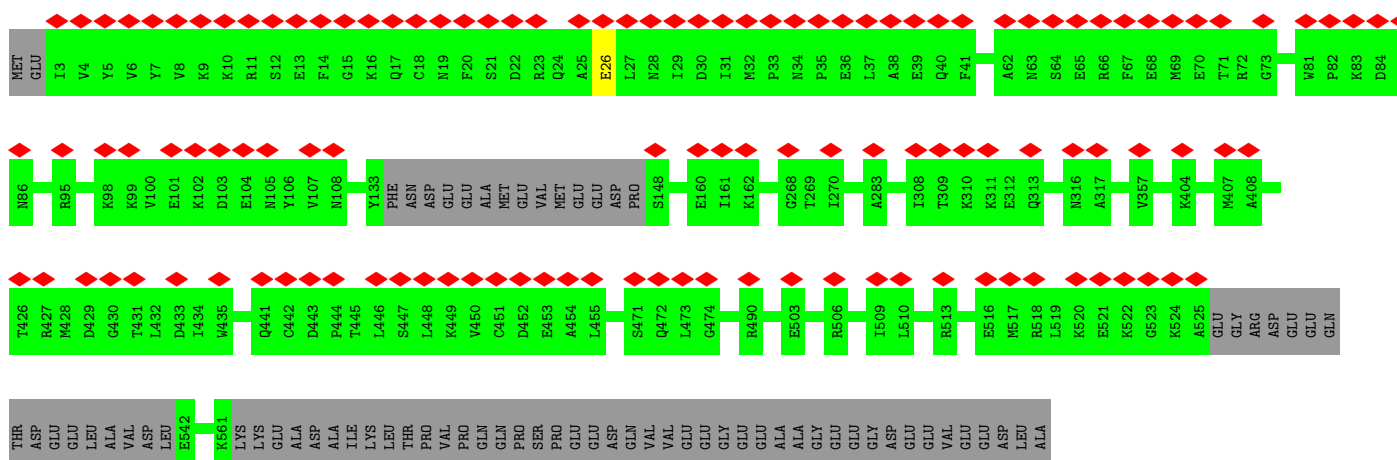
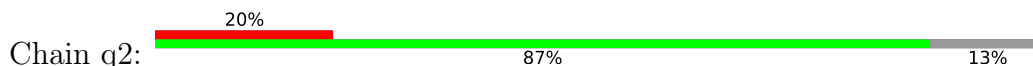

• Molecule 97: Dynein axonemal intermediate chain 2

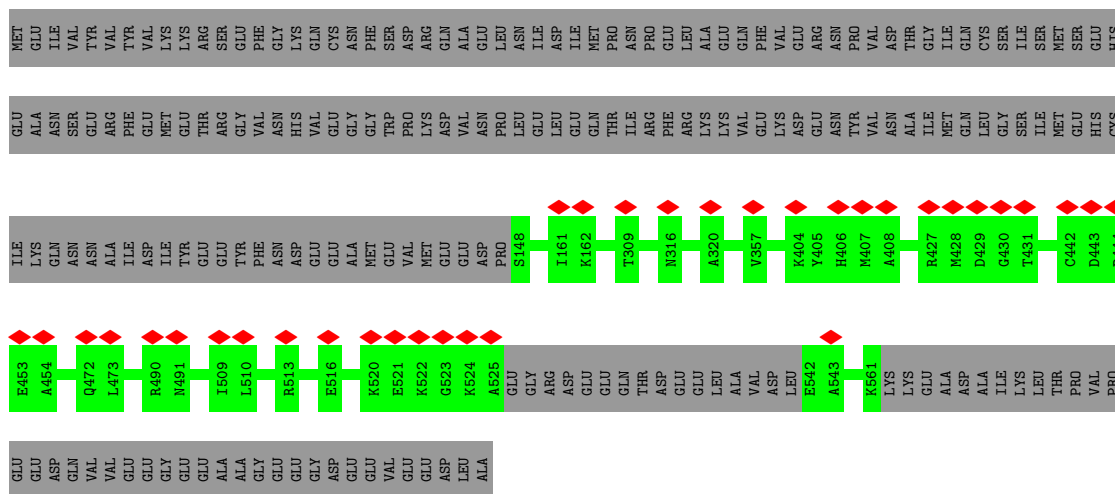

• Molecule 98: Dynein axonemal light chain 1

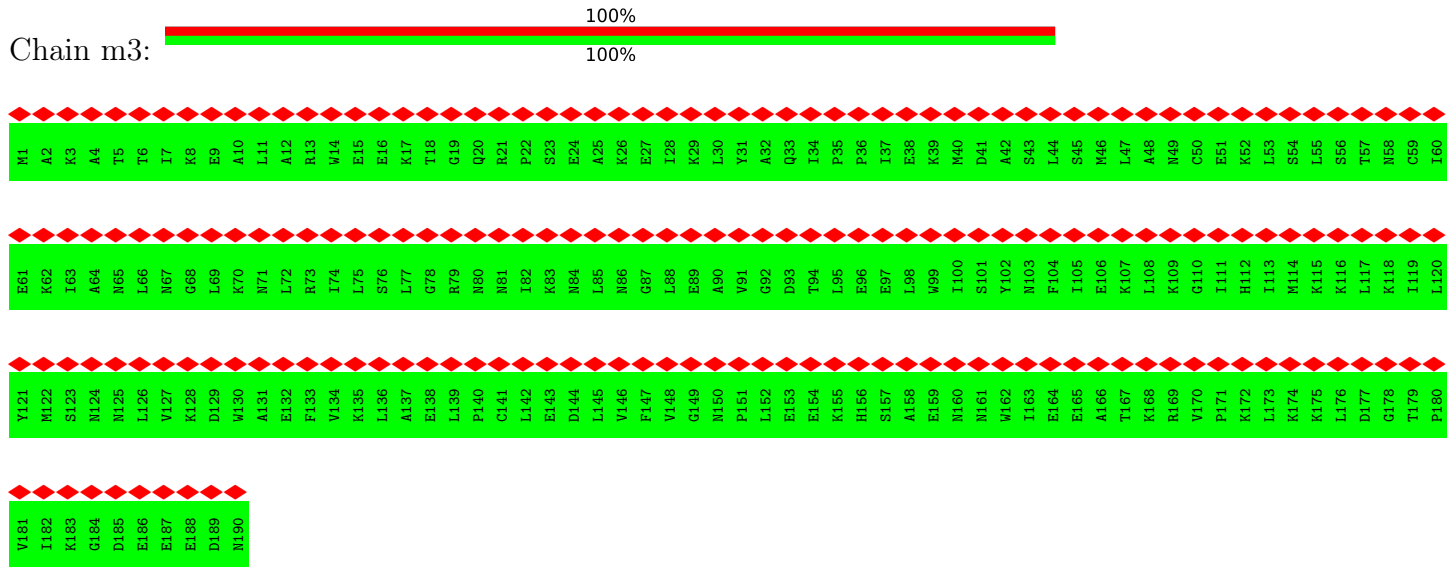

● Molecule 98: Dynein axonemal light chain 1

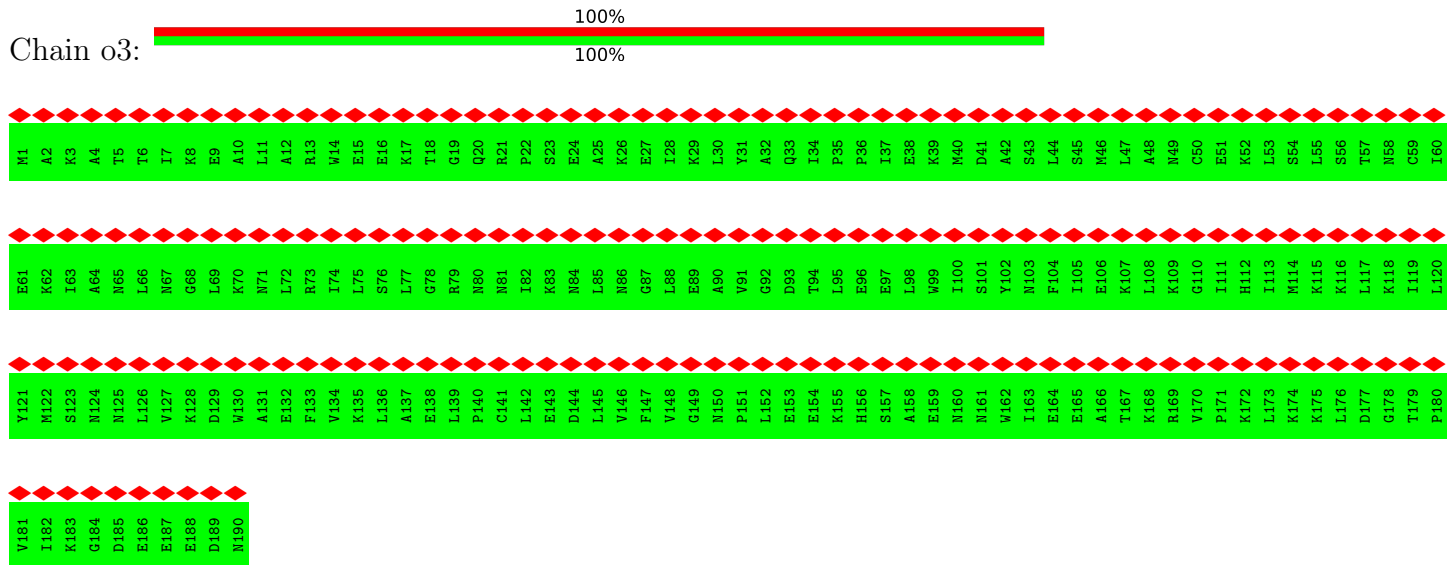

● Molecule 98: Dynein axonemal light chain 1

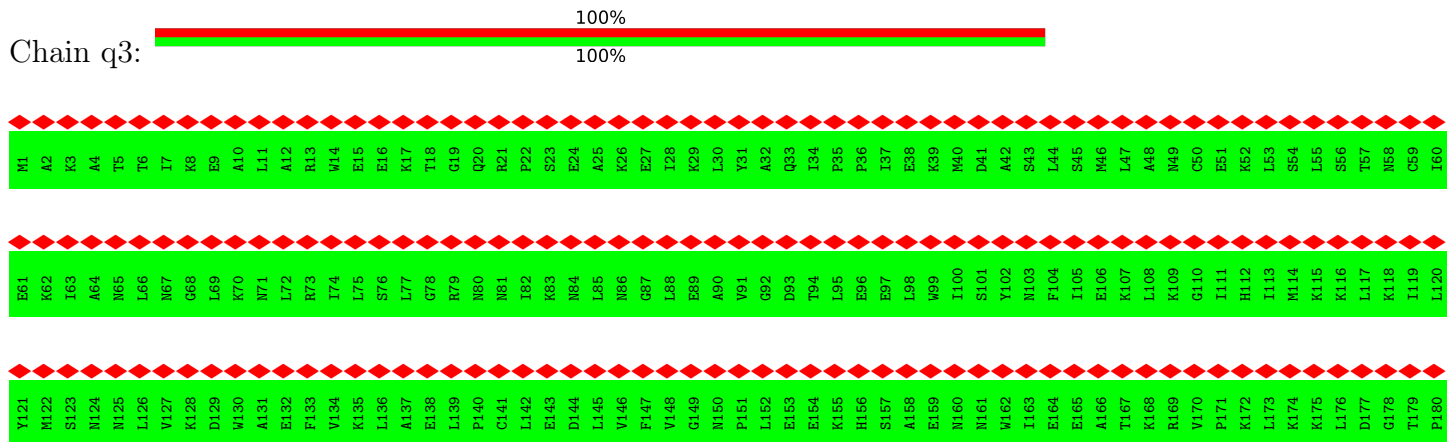

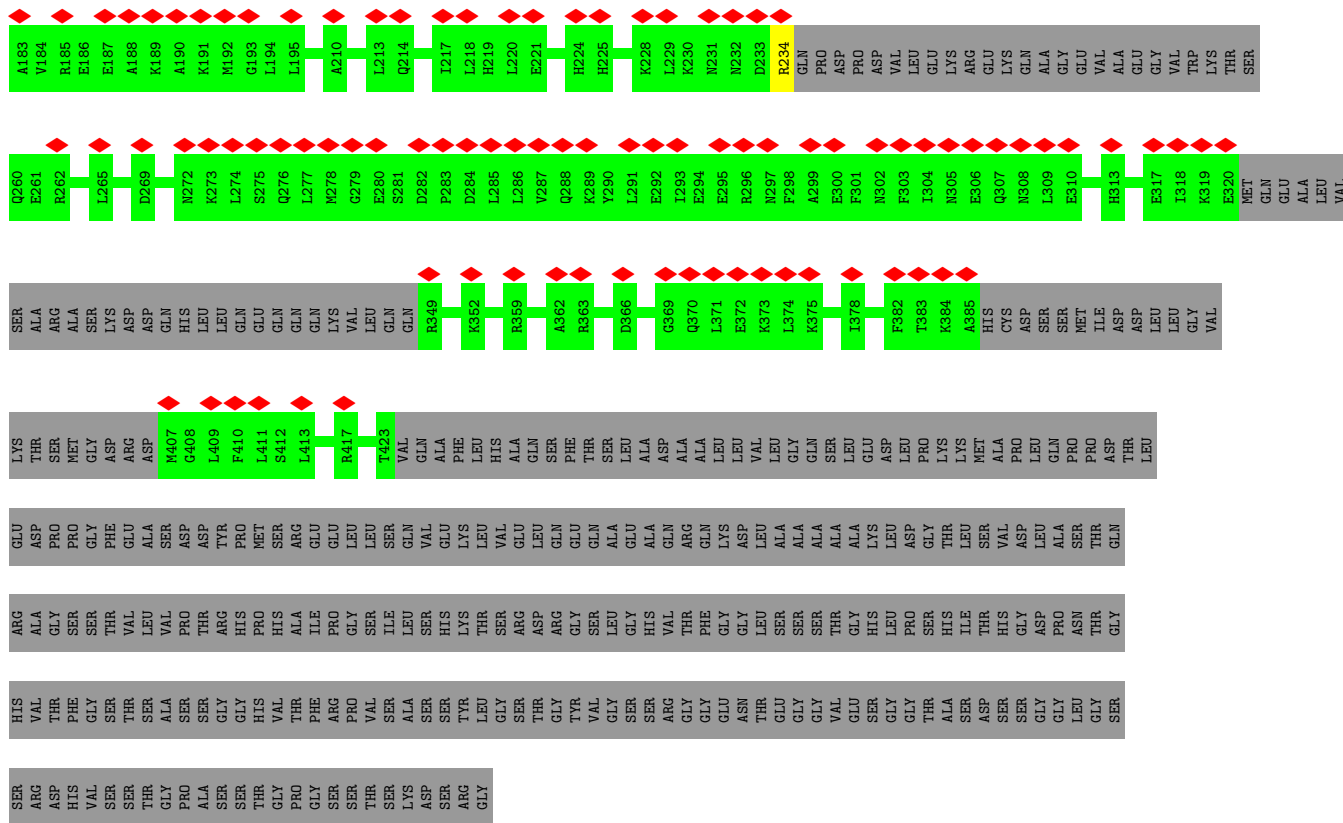

● Molecule 99: Outer dynein arm-docking complex subunit 1

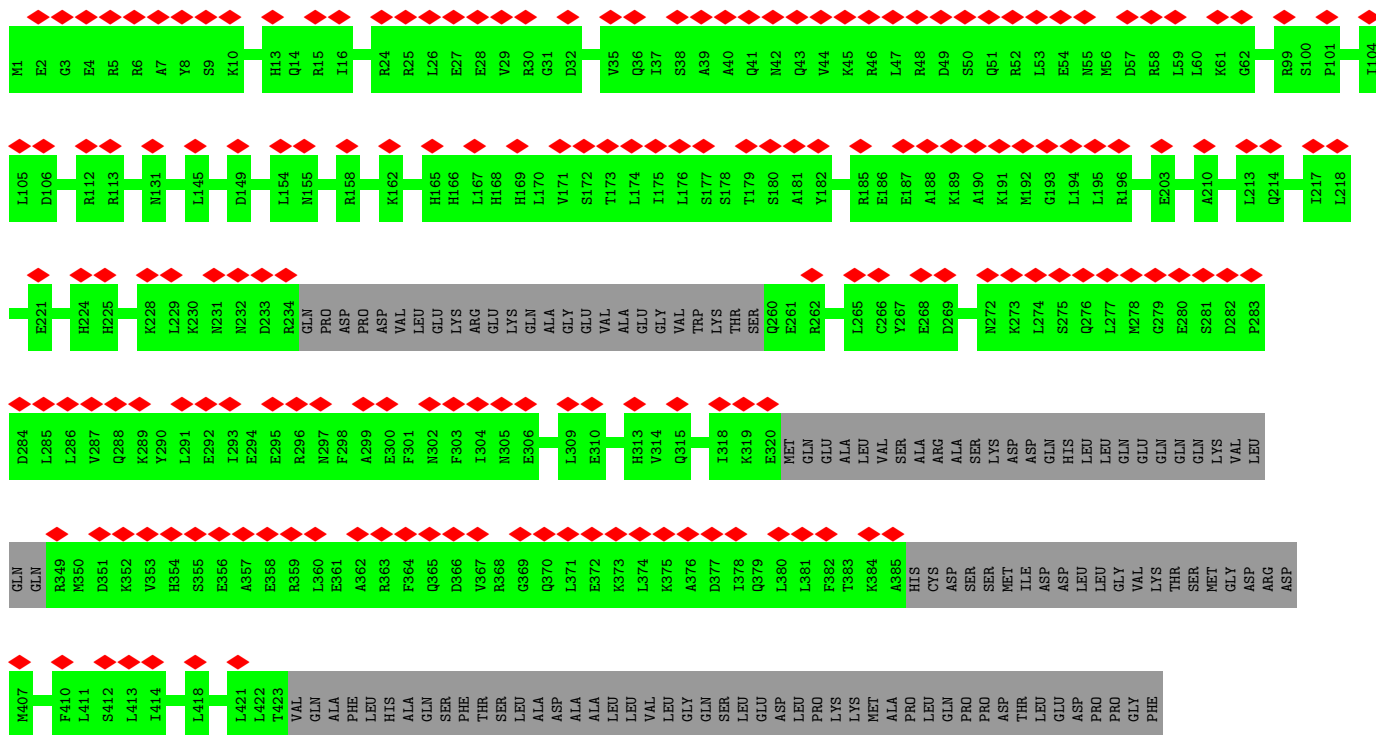

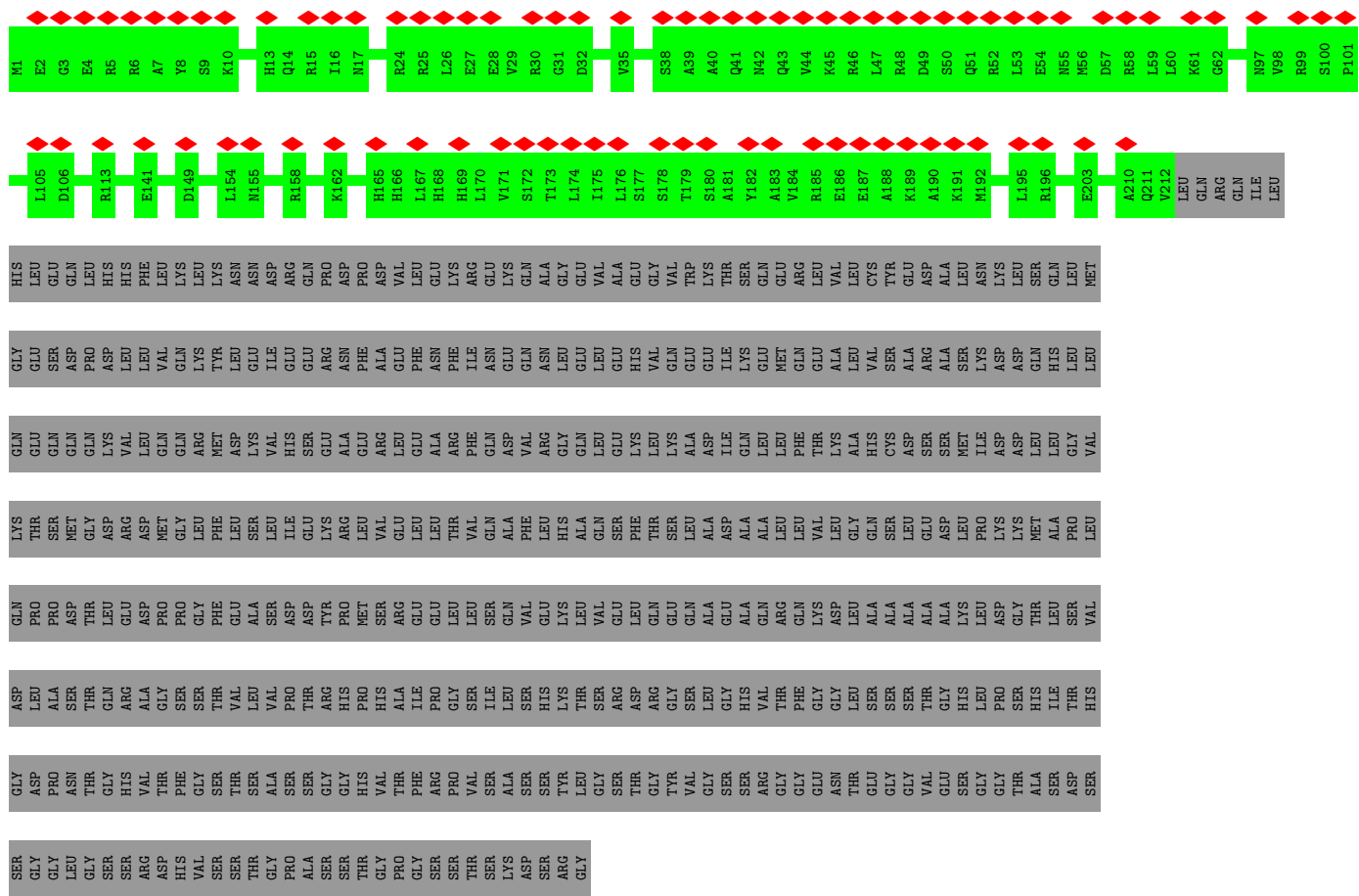

● Molecule 100: Outer dynein arm-docking complex subunit 2

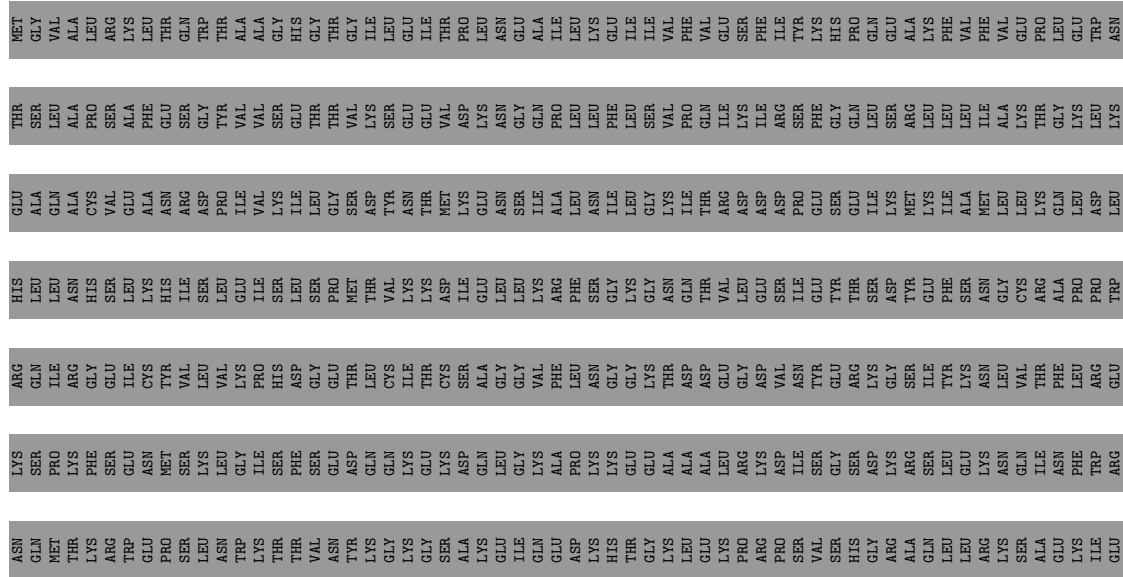

● Molecule 101: Outer dynein arm-docking complex subunit 3

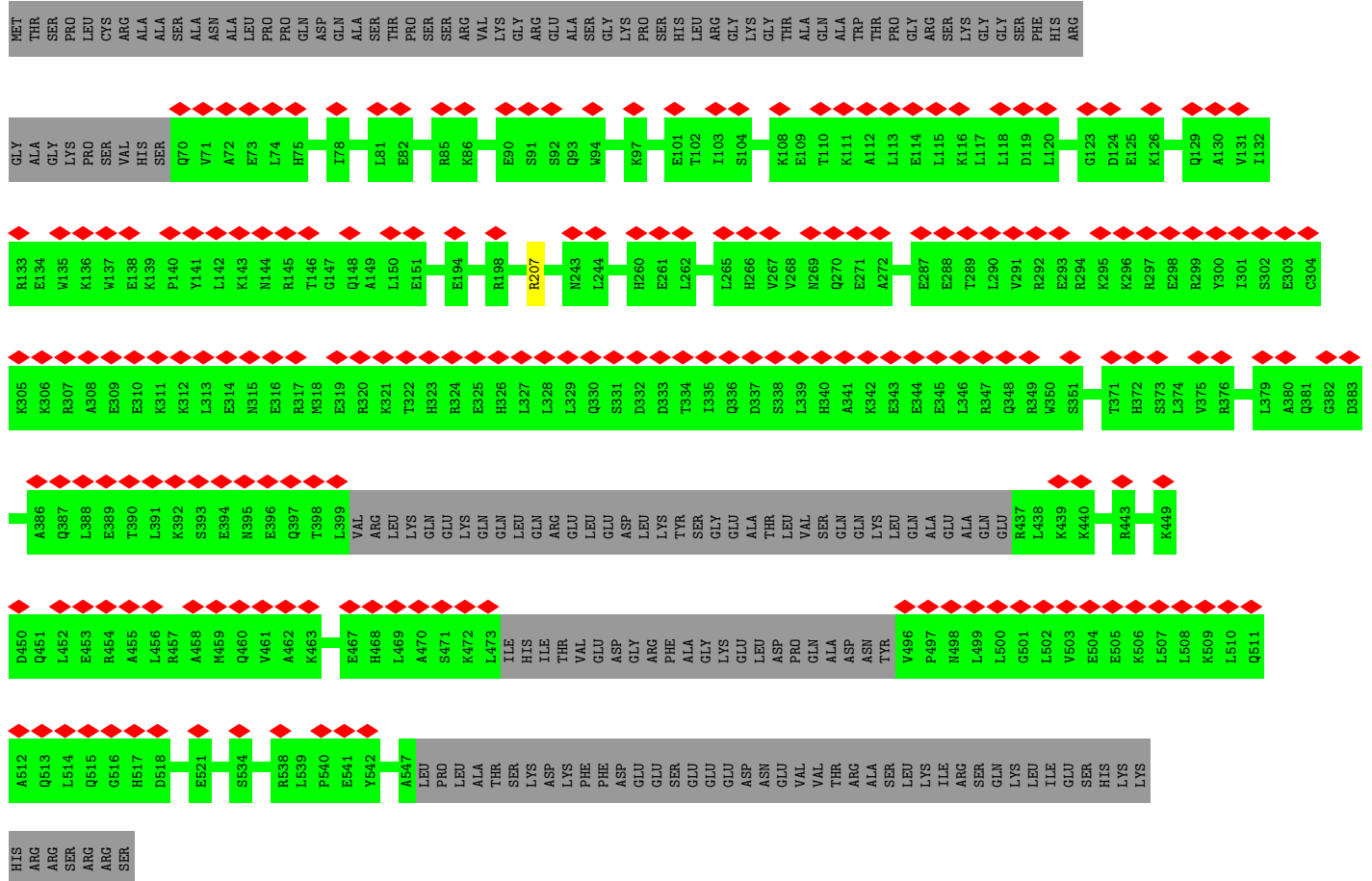
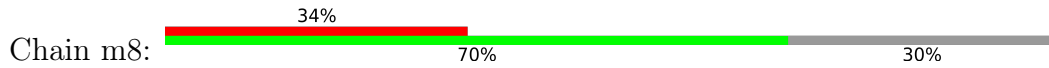

● Molecule 101: Outer dynein arm-docking complex subunit 3

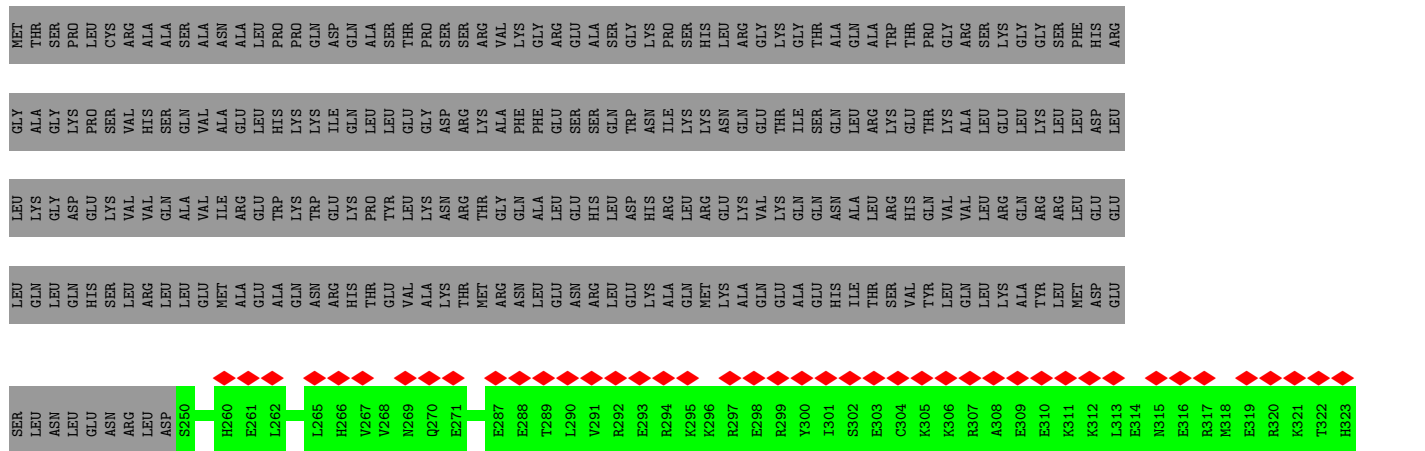

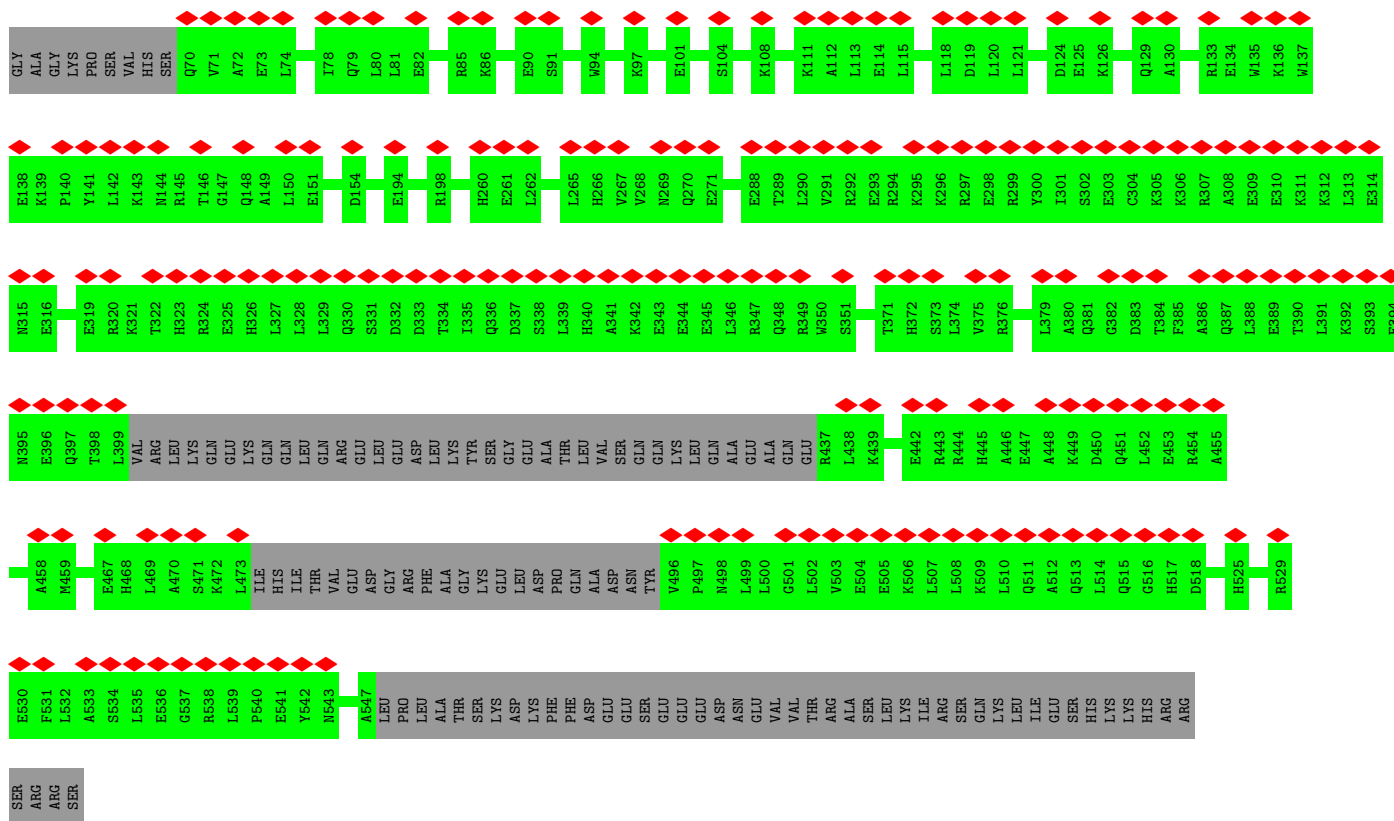

- Molecule 101: Outer dynein arm-docking complex subunit 3

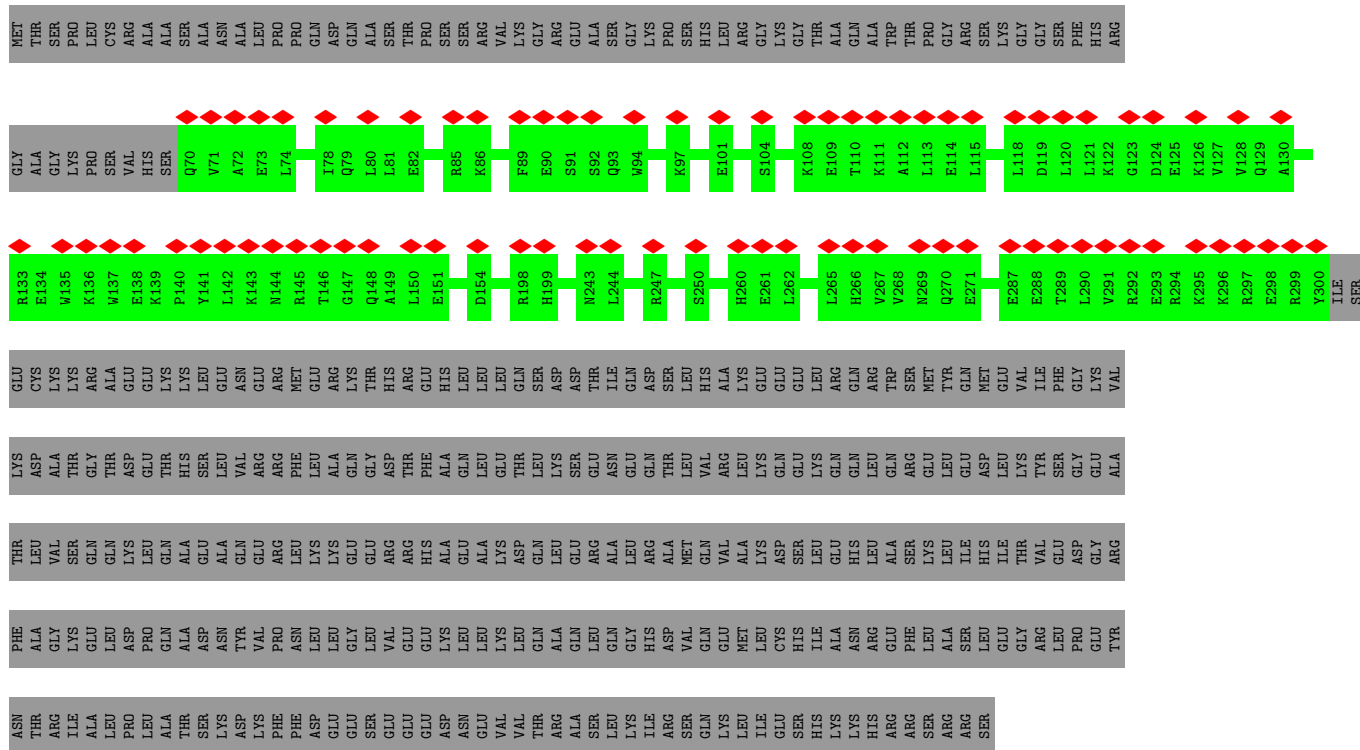

● Molecule 102: Outer dynein arm-docking complex subunit 4

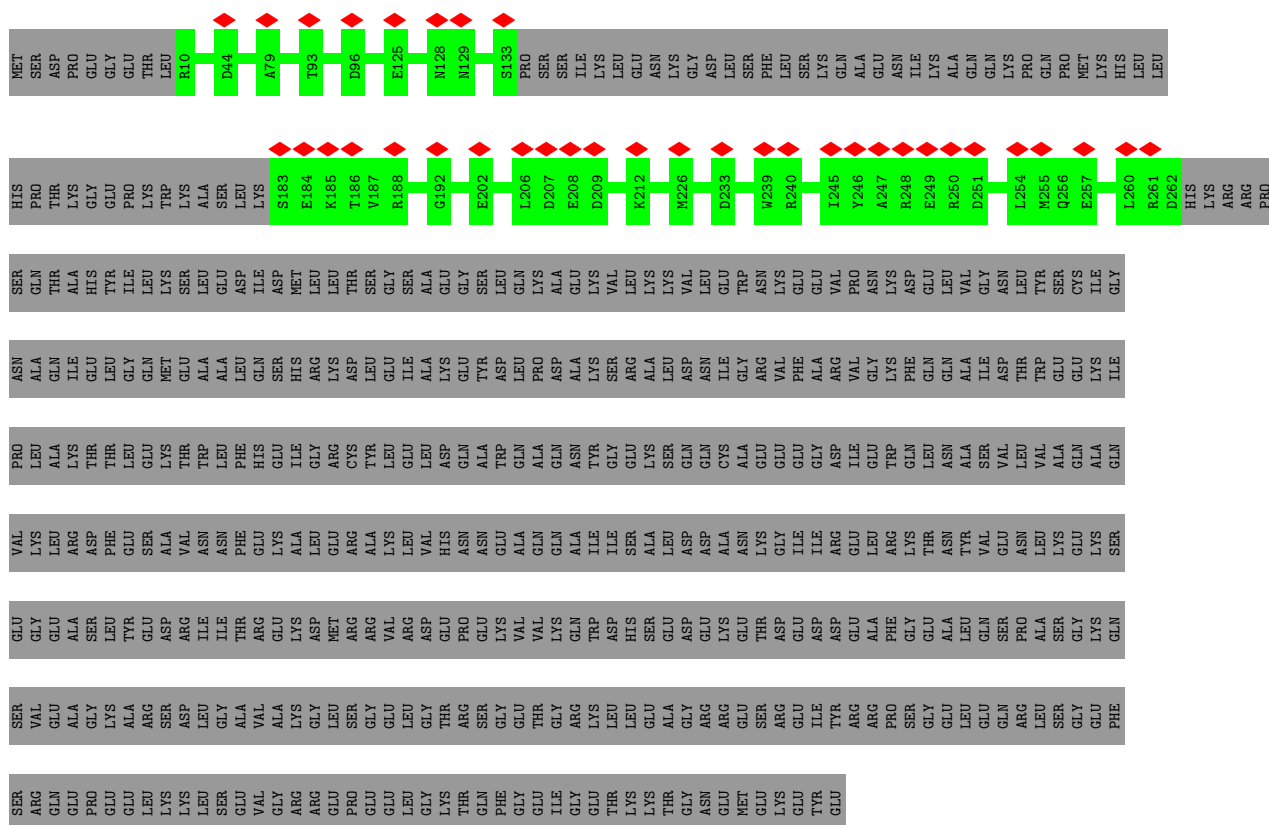

● Molecule 102: Outer dynein arm-docking complex subunit 4

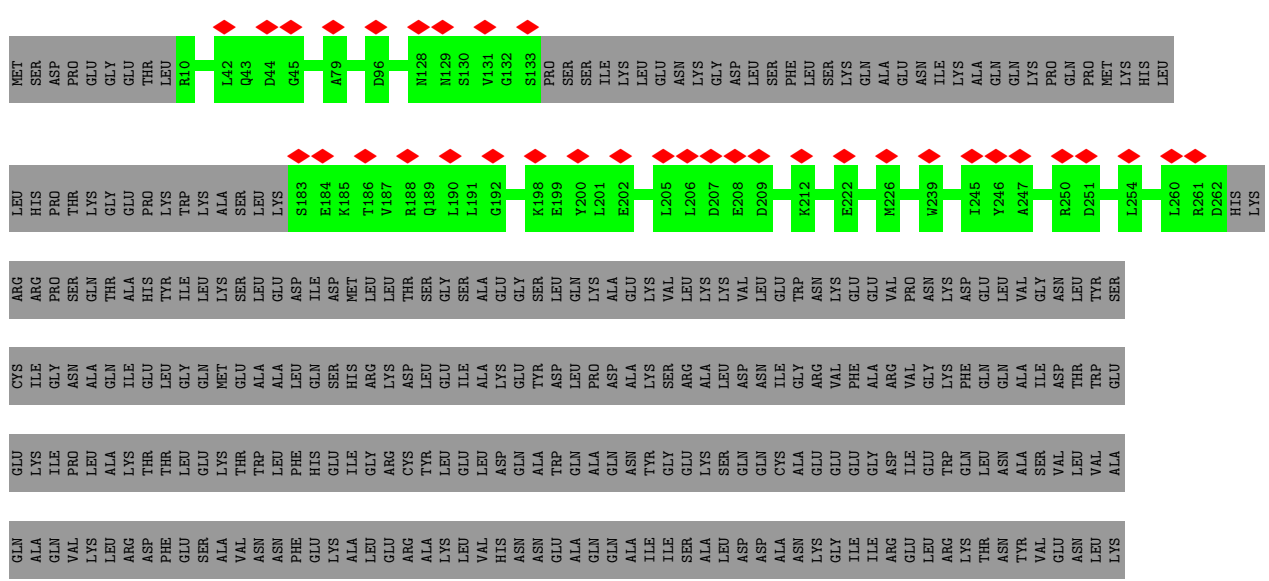

F1639	V1640	G1641	G1642	D1643	I1644	A1645	K1646	Q1647	L1648	P1649	K1650	E1651	A1652	K1653	R1654	F1655	S1656	M1657	I1658	D1659	K1660	S1661	W1662	V1663	K1664	I1665	M1666	T1667	R1668	A1669	H1670	E1671	V1672	P1673	S1674	V1675	V1676	Q1677	C1678	C1679	V1680	G1681	D1682	E1683	T1684	L1685	G1686	Q1687	L1688	L1689	P1690	L1692	L1693	D1694	Q1695	L1696	E1697	I1698
C1699	Q1700	K1701	S1702	L1703	T1704	G1705	Y1706	L1707	E1708	K1709	K1710	V1720	S1721	D1722	P1723	A1724	L1725	L1726	E1727	I1728	L1729	G1730	Q1731	A1732	S1733	L1734	S1735	H1736	T1737	K1753	F1754	H1755	E1756	K1757	I1758	Y1759	D1760	R1761	E1774	L1775	D1776	K1777	P1778	V1779	M1780	A1781	E1782	G1783	Q1787	L1788	L1789	V1785	L1786	V1787	S1791	E1794		
E1795	S1798	S1799	L1900	H1801	L1902	V1903	S1910	I1904	R1905	Q1906	A1907	A1908	A1909	M1910	I1911	Q1912	E1913	T1914	G1915	F1916	Q1917	L1918	T1919	I1920	F1921	L1922	S1923	S1924	F1925	M1936	I1937	W1938	T1939	L1940	D1941	S1942	E1943	E1944	A1945	L1946	R1947	M1948	A1949	K1950	F1951	D1952	K1953	I1955	M1956	Q1957	K1958	L1959	V1986	M1960	Q1961	A1962	E1965	
C1904	H1905	M1906	H1907	I1908	K1909	S1910	P1911	M1912	D1913	Y1923	F1924	M1925	E1926	D1927	S1928	L1929	K1930	M1931	Q1931	L1932	G1976	A1977	P1978	A1979	G1980	P1981	A1982	Q2009	L2015	F2031	F2034	M2035	R2036	A2046	T2054	K2061	G2068	L2081	T2082	M2083	M2084	P2085	G2086	Y2087	A2088	G2089	L2093											
P2094	E2095	N2096	L2097	K2098	L2099	N2100	F2101	R2102	S2103	L2140	Q2144	L2145	S2146	K2147	Q2148	V2149	H2150	Y2151	L2190	S2191	K2192	L2193	I2194	D2195	E2196	D2197	E2198	P2199	L2200	F2201	L2202	S2203	L2204	I2205	E2206	D2207	L2208	F2209	P2210	M2211	I2212	L2213	L2214	D2215	K2216	A2217	G2218	Y2219	P2220	E2221	L2222	E2223	A2224	A2225	I2226	S2227		
R2228	Q2229	V2230	E2231	E2232	A2233	G2234	L2235	L2236	W2237	H2238	P2239	W2240	W2241	K2242	L2243	K2244	V2245	L2246	Q2247	L2248	G2257	M2258	W2259	T2260	L2261	G2262	P2263	S2264	G2265	A2266	K2268	T2269	T2270	C2271	L2272	H2273	T2274	L2275	M2276	R2277	T2280	D2281	C2282	G2283	K2284	P2285	H2286	R2287	E2288	M2289	R2290	L2292	M2291	W2292	P2293	K2294	A2295	
I2296	T2297	A2298	P2299	Q2300	M2301	F2302	G2303	R2304	L2305	D2306	V2307	A2308	T2309	N2310	D2311	W2312	T2313	D2314	G2315	I2316	F2317	S2318	T2319	L2320	W2321	R2322	K2323	S2400	S2401	I2402	L2403	D2404	W2405	P2407	L2408	E2410	G2411	F2412	L2413	K2414	K2415	R2416	S2417	P2418	Q2419	E2420	A2421	E2422	L2423	L2424	R2425	Q2426	L2427	Y2428	T2429	E2430		
G2364	D2365	R2366	L2367	N2372	L2375	L2376	F2377	E2378	P2379	H2380	L2443	N2381	Y2445	K2446	M2447	E2448	V2449	S2450	E2451	M2393	G2394	M2395	V2396	F2397	M2398	S2399	S2400	S2401	I2402	L2403	D2404	W2405	P2407	L2408	E2410	G2411	F2412	L2413	K2414	K2415	R2416	S2417	P2418	Q2419	E2420	A2421	E2422	L2423	L2424	R2425	Q2426	L2427	Y2428	E2430				
S2431	F2432	P2433	D2434	Y2436	R2437	F2438	C2439	T2440	Q2441	N2442	L2443	E2444	Y2445	K2446	M2447	E2448	V2449	L2450	E2451	A2452	F2453	V2454	L2455	T2456	Q2457	S2458	L2459	N2460	M2461	L2462	Q2463	G2464	L2465	T2466	P2467	L2468	K2469	E2470	Q2471	G2472	G2473	E2474	V2475	S2476	Q2477	A2478	H2479	G2481	R2482	L2483	L2484	V2485	F2486	A2487	L2488	L2489	W2490	
S2491	A2492	G2493	A2494	L2496	E2497	L2498	D2499	G2500	R2501	R2502	L2503	L2504	E2505	L2506	W2507	L2508	R2509	S2510	L2511	P2512	T2513	G2514	T2515	L2516	E2517	L2518	P2519	P2520	P2521	A2522	G2523	P2524	G2525	D2526	T2527	F2528	P2529	D2530	Y2531	Y2532	Y2533	A2534	P2535	D2536	G2537	T2538	W2539	L2540	H2541	W2542	N2543	T2544	E2545	E2548	N2566	V2567		
D2568	N2569	V2570	R2571	T2572	D2573	F2574	L2575	Q2577	T2578	L2579	A2580	K2581	Q2582	G2583	K2584	A2585	V2586	L2587	L2588	L2589	G2590	E2591	Q2592	G2593	T2594	A2595	K2596	T2597	V2598	L2599	L2600	K2601	G2602	F2603	M2604	K2606	Y2607	D2608	P2609	E2610	C2611	H2612	M2613	L2614	S2620	S2621	A2622	W2640	P2647	A2648	G2649	K2650	K2651	N2652				
T2653	V2654	F2655	L2656	D2657	D2658	V2659	N2660	M2661	P2662	L2664	L2665	E2666	W2667	G2668	D2669	Q2670	V2671	T2672	N2673	E2674	R2677	Q2678	L2679	M2680	E2681	Q2682	N2683	Y2686	N2687	L2779	K2780	M2781	G2692	E2693	F2694	D2699	L2700	Q2701	F2702	L2703	A2704	A2705	M2706	L2707	H2708	P2709	G2710	G2711	G2712	R2713	N2714	D2715	L2716	P2717	Q2718	R2719		
L2720	K2721	R2722	Q2723	F2724	S2725	L2726	F2727	M2728	C2729	P2730	L2731	P2732	S2733	E2734	A2735	S2736	Q2752	R2753	G2754	F2755	S2756	E2757	R2772	L2773	W2774	Q2775	W2776	T2777	K2778	L2779	K2780	M2781	L2782	P2783	T2784	F2785	F2788	Q2791	F2792	M2793	E2810	K2813	E2814	W2842	F2843	D2844	K2845	A2846	L2847	V2848	S2849	L2850						

V2851	E2852	E2853	E2854	F2855	G2856	E2857	E2858	K2859	K2860	L2861	L2862	L2863	L2864	C2865	G2866	L2867	L2875	R2876	D2877	A2878	F2879	E2880	A2881	A2882	E2883	E2884	T2885	S2886	E2887	E2888	A2889	F2903	S2904	H2905	E2908	R2909	L2910	R2911	H2912	F2913	L2914	Q2915	L2916	Y2917	H2918	E2919	S2920	L2921	H2922	G2923	A2924	L2982	T2983	R2984	S2985				
Y2986	N2987	T2988	S2989	N2990	L2991	M2992	E2993	D2994	L2995	K2996	V2997	R3000	Q3004	Q3005	I3018	K3019	D3020	E3021	S3022	F3023	L3024	E3025	Y3026	F3040	A3041	R3042	D3043	E3044	I3045	D3046	E3047	I3048	N3049	S3050	D3051	L3052	A3053	S3054	V3055	M3056	K3057	K3058	P3061	T3066	N3067	E3068	N3069	S3070	H3071	D3072	Y3073	F3074							
G3092	E3093	K3094	F3095	R3096	N3097	R3098	A3099	L3100	K3101	F3102	P3103	I3106	S3107	T3131	S3132	Y3133	D3134	L3135	D3136	C3137	S3138	L3139	E3140	I3141	K3142	K3143	H3193	V3194	E3195	V3196	R3197	T3198	L3199	A3200	N3201	R3202	M3203	N3204	T3205	G3206	L3207	E3208	K3209	L3210	K3211	E3212	A3213	S3214	E3215	S3216	V3217	A3218	A3219	L3220	S3221	K3222			
E3223	L3224	E3225	A3226	K3227	E3228	K3229	E3230	L3231	Q3232	V3233	A3234	N3235	D3236	A3238	D3239	M3240	V3241	L3242	K3243	E3244	V3245	T3246	M3247	K3248	A3249	Q3250	A3251	A3252	E3253	K3254	V3255	K3256	A3257	E3258	Q3259	Q3260	K3261	V3262	K3263	D3264	R3265	A3266	Q3267	E3268	L3269	V3270	D3271	S3272	L3273	S3274	K3275	D3276	K3277	A3278	L3279	A3280	E3281	E3282	
K3283	L3284	E3285	A3286	K3287	K3288	P3289	A3290	L3291	E3292	E3293	A3294	E3295	A3296	A3297	L3298	Q3299	T3300	I3301	R3302	P3303	S3304	D3305	I3306	A3307	T3308	V3309	R3310	T3311	L3312	G3313	R3314	P3315	H3317	L3318	I3319	M3320	R3321	I3322	M3323	D3324	C3325	V3326	L3327	L3328	L3329	F3330	Q3331	R3332	K3333	V3334	S3335	A3336	V3337	K3338	I3339	D3340	L3341	E3342	
K3343	S3344	C3345	T3346	K3347	P3348	S3349	K3350	Q3351	E3352	S3353	L3354	K3355	L3356	M3357	T3358	G3359	N3360	F3361	F3362	L3363	N3365	L3366	Q3367	T3368	A3369	P3370	K3371	D3372	T3373	I3374	N3375	E3376	E3377	V3378	L3379	E3380	M3441	R3442	S3443	P3444	Y3445	K3446	A3447	P3448	A3449	E3450	L3451	R3452	D3453	K3454	Q3455	A3456	E3457	L3458	R3459	V3460	G3461	N3462	
V3403	A3404	G3405	L3406	K3407	S3408	W3409	T3410	K3411	A3412	M3413	A3414	S3415	F3416	F3417	S3418	I3419	N3420	K3421	E3422	V3423	L3424	P3425	L3426	K3427	A3428	N3429	L3430	V3431	R3432	Q3433	E3434	N3435	R3436	H3437	L3438	L3439	A3440	M3441	Q3442	D3443	L3444	Q3445	K3446	A3447	P3448	A3449	E3450	L3451	R3452	D3453	K3454	Q3455	A3456	E3457	L3458	R3459	V3460	G3461	Q3462
A3463	E3464	Y3465	E3466	Q3467	A3468	M3469	T3470	E3471	K3472	Q3473	T3474	L3475	L3476	E3477	D3478	A3479	E3480	R3481	C3482	R3483	H3484	K3485	M3486	Q3487	T3488	A3489	S3490	T3491	L3492	I3493	S3494	G3495	L3496	A3497	G3498	E3499	K3500	E3501	R3502	W3503	T3504	E3505	Q3506	S3507	Q3508	E3509	F3510	A3511	Q3512	Q3513	T3514	K3515	K3551	A3552	R3553	K3554	I3555	P3556	
K3559	A3570	P3571	T3572	I3573	S3574	E3575	L3602	L3603	I3604	D3605	P3606	Q3607	T3608	Q3609	G3610	K3611	I3612	K3615	N3616	K3617	E3618	S3619	R3620	N3621	E3622	L3623	Q3624	I3625	T3626	S3627	L3628	N3629	H3630	K3631	Y3632	R3633	F3634	N3635	H3636	L3637	E3638	D3639	S3640	L3641	S3642	L3643	G3644	R3645	P3646	L3647	L3648	I3649	E3650	D3651	V3652				
G3653	E3654	E3655	L3656	D3657	P3658	A3659	L3660	D3661	F3668	L3669	K3670	T3671	G3672	S3673	T3674	F3675	K3676	V3677	K3678	V3679	G3680	D3681	K3682	E3683	V3684	D3685	S3686	V3687	L3688	G3689	I3689	T3690	S3691	L3692	K3693	P3694	N3700	P3701	A3702	Y3703	D3715	F3716	T3717	V3731	L3732	L3733	T3734	E3735	K3736	Q3737	E3738	L3739	E3740	K3741	E3742				
R3743	T3744	H3745	L3746	M3747	E3748	D3749	V3750	T3751	A3752	N3753	K3754	R3755	R3756	M3757	K3758	E3759	L3760	E3761	D3762	N3763	L3764	L3765	Y3766	R3767	L3768	T3769	S3770	T3771	Q3772	G3773	S3774	L3775	V3776	E3777	D3778	E3779	S3780	L3781	I3782	V3783	L3784	L3785	S3786	N3787	T3788	K3789	R3790	T3791	A3792	E3793	E3794	V3795	L3796	Q3797	K3798	L3799	I3800	S3802	
A3803	E3804	T3805	E3806	R3807	Q3808	L3809	N3810	S3811	A3812	R3813	E3814	E3815	Y3816	R3817	P3818	V3819	A3856	R3857	S3858	V3859	K3860	S3861	P3862	I3863	T3864	S3865	K3866	D3867	I3868	A3869	N3870	L3871	L3872	E3873	K3881	A3884	R3885	G3886	L3887	Y3888	E3889	E3890	H3891	K3892	F3893	L3894	I3903	D3904	I3905	Q3906	R3907	N3908	R3909	V3910	K3911	I3971			
H3912	E3913	E3914	F3915	L3916	T3917	L3918	L3919	K3920	G3921	G3922	A3923	S3924	L3925	D3926	L3927	K3928	A3929	C3930	P3931	P3932	K3933	P3934	S3935	K3936	K3937	L3938	L3939	D3940	T3941	T3942	W3943	L3944	L3945	L3946	V3947	E3948	S3950	K3951	L3952	R3953	Q3954	F3955	S3956	H3957	K3958	L3959	K3960	L3962	S3963	K3964	N3965	E3966	K3967	K3968	W3969	K3970	I3971		

K3972	F3973	D3974	K3975	E3976	N3977	F3978	E3979	E3980	E3981	F3982	L3983	F3984	N3985	A3986	F3987	D3988	K3989	S3990	L3991	D3992	C3993	F3994	K3995	R3996	L3997	L3998	L3999	I4000	R4001	S4002	W4003	C4004	P4005	D4006	R4007	T4008	I4009	A4010	Q4011	A4012	R4013	K4014	Y4015	I4016	V4017	D4018	S4019	M4020	E4022	K4023	Y4024	E4026	G4027	V4028	I4029	L4030	D4031	L4032	E4033	K4034	T4035	W4036	E4037	S4038	S4039	D4040	P4041	R4042	T4043	P4044	L4045	I4046	C4047	L4048	L4049	S4050	M4051	G4052	S4053	D4054	P4055	T4056	D4057	S4058	I4059	A4061	L4062	G4063	K4064	R4065	L4066	K4067	I4068	E4069	T4070	R4071	Y4072	Y4073	S4074	M4075	Q4079	H4082	A4083	R4084	K4085	L4086	L4087	Q4088	Q4089	T4090	G4021	M4091	A4092	N4093	G4094	G4095	W4096	A4097	L4098	L4099	Q4100	M4101	C4102	H4103	D4110	E4111	L4112	M4113	D4114	I4115	I4117	E4118	T4119	L4120	L4121	V4122	H4123	D4124	A4125	F4126	R4127	L4128	W4129	M4130	T4131	T4132	E4133	A4134	M4145	S4146	I4147	K4148	F4149	A4150	M4151	D4152	P4153	P4154	Q4214	A4215	D4216	R4158	A4159	C4160	L4161	K4162	Q4088	R4163	T4164	Y4165	S4166	C4167	V4168	S4169	Q4170	D4171	L4172	L4173	D4174	V4175	S4176	S4177	G4178	S4179	Q4180	W4181	K4182	F4183	M4184	L4185	Y4186	A4187	V4188	A4189	F4190	L4191	H4192	S4193	T4194	V4195	Q4196	E4197	R4198	R4199	K4200	F4201	G4202	A4203	L4204	G4205	N4206	M4207	I4208	P4209	Y4210	E4211	F4212	M4213	Q4214	A4215	D4216	R4217	M4218	L4228	D4229	D4230	M4231	D4232	V4233	K4234	K4235	G4236	V4237	S4238	W4239	T4240	Y4244	Y4251	G4252	G4253	R4254	V4255	T4256	D4257	D4258	Y4259	D4260	K4261	R4262	L4263	L4264	M4265	T4266	F4267	A4268	K4269	V4270	M4271	F4272	S4273	E4274	M4275	M4276	F4277	G4278	P4279	D4280	F4281	S4282	F4283	Y4284	Q4285	G4286	Y4287	N4288	I4289	P4290	K4291	C4292	S4293	T4294	V4295	D4296	M4297	Y4298	L4299	Q4300	Y4301	I4302	Q4303	S4304	L4305	P4306	A4307	E4308	D4309	S4310	P4311	A4312	V4313	F4314	Q4315	L4316	H4317	P4318	M4319	A4320	D4321	L4322	T4323	Y4324	Q4325	S4326	K4327	L4328	A4329	K4330	D4331	V4332	D4334	T4335	L4336	L4337	G4338	S4345	G4346	G4347	G4348	D4349	E4350	A4354	V4355	V4356	M4427	R4428	L4428	L4429	D4430	A4431	L4432	D4433	C4434	M4435	F4436	D4437	A4438	R4439	I4440	Y4371	V4372	P4373	F4374	E4375	V4376	K4377	E4378	L4380	Q4381	K4382	G4384	P4385	F4386	Q4387	M4388	M4389	M4390	I4391	F4392	L4393	R4394	Q4395	Q4401	R4402	V4403	L4404	S4405	L4406	T4407	R4408	S4409	T4410	L4411	T4412	E4413	L4414	K4415	L4416	M4424	S4425	E4426	M4427	R4428	L4428	K4429	D4430	A4431	L4432	D4433	C4434	M4435	F4436	D4437	A4438	R4439	I4440	P4441	A4442	W4443	W4444	K4445	L4446	S4452	T4453	L4454	I4462	M4465	S4466	T4469	S4470	W4471	V4472	F4473	M4474	C4475	R4476	P4477	H4478	C4479	F4480	W4481	M4482	F4485	P4488	Q4489	G4490	F4491	L4492	T4493	A4494	M4495	R4496	Q4497	E4498	I4499	T4500	R4501	A4502	M4503	K4504	C4505	W4506	A4507	L4508	D4509	M4510	M4511	V4512	L4513	C4514	M4515	E4516	V4517	T4518	K4519	M4520	M4521	K4522	D4523	D4524	I4525	S4526	A4527	P4528	P4529	T4530	E4531	G4532	V4533	Y4534	V4535	Y4536	L4540	E4541	G4542	A4543	G4544	W4545	D4546	K4547	R4548	M4549	M4550	K4551	L4552	I4553	E4554	S4555	M4556	P4557	K4558	V4559	L4560	F4561	E4562	L4563	M4564	P4565	V4566	I4567	R4568	I4569	Y4570	A4571	E4572	M4573	M4574	T4575	L4576	R4577	D4578	P4579	R4580	F4581	R4582	F4583	S4583	C4584	P4585	V4591	R4592	T4593	T4594	I4598	A4599	A4600	V4601	D4602	L4603	R4604	T4605	A4606	Q4607	T4608	P4609	E4610	H4611	W4612	V4613	L4614	R4615	G4616	V4617	A4618	C4621	D4622	V4623	LYS	M1	F2	R3	I4	G5	R6	R7	Q8	L9	W10	K11	H12	G704	E705	V13	T15	R16	V17	L18	T19	Q20	R21	L22	K23	G24	E25	L95	G96	S97	L98	G99	G100	L4615	G4616	V4617	A4618	Q190	A193	N194	K218	E219	N272	K378	M379	I380	Y381	S382	I383	S384	K452	L453	K454	Q455	M456	P457	N458
-------	-------	-------	-------	-------	-------	-------	-------	-------	-------	-------	-------	-------	-------	-------	-------	-------	-------	-------	-------	-------	-------	-------	-------	-------	-------	-------	-------	-------	-------	-------	-------	-------	-------	-------	-------	-------	-------	-------	-------	-------	-------	-------	-------	-------	-------	-------	-------	-------	-------	-------	-------	-------	-------	-------	-------	-------	-------	-------	-------	-------	-------	-------	-------	-------	-------	-------	-------	-------	-------	-------	-------	-------	-------	-------	-------	-------	-------	-------	-------	-------	-------	-------	-------	-------	-------	-------	-------	-------	-------	-------	-------	-------	-------	-------	-------	-------	-------	-------	-------	-------	-------	-------	-------	-------	-------	-------	-------	-------	-------	-------	-------	-------	-------	-------	-------	-------	-------	-------	-------	-------	-------	-------	-------	-------	-------	-------	-------	-------	-------	-------	-------	-------	-------	-------	-------	-------	-------	-------	-------	-------	-------	-------	-------	-------	-------	-------	-------	-------	-------	-------	-------	-------	-------	-------	-------	-------	-------	-------	-------	-------	-------	-------	-------	-------	-------	-------	-------	-------	-------	-------	-------	-------	-------	-------	-------	-------	-------	-------	-------	-------	-------	-------	-------	-------	-------	-------	-------	-------	-------	-------	-------	-------	-------	-------	-------	-------	-------	-------	-------	-------	-------	-------	-------	-------	-------	-------	-------	-------	-------	-------	-------	-------	-------	-------	-------	-------	-------	-------	-------	-------	-------	-------	-------	-------	-------	-------	-------	-------	-------	-------	-------	-------	-------	-------	-------	-------	-------	-------	-------	-------	-------	-------	-------	-------	-------	-------	-------	-------	-------	-------	-------	-------	-------	-------	-------	-------	-------	-------	-------	-------	-------	-------	-------	-------	-------	-------	-------	-------	-------	-------	-------	-------	-------	-------	-------	-------	-------	-------	-------	-------	-------	-------	-------	-------	-------	-------	-------	-------	-------	-------	-------	-------	-------	-------	-------	-------	-------	-------	-------	-------	-------	-------	-------	-------	-------	-------	-------	-------	-------	-------	-------	-------	-------	-------	-------	-------	-------	-------	-------	-------	-------	-------	-------	-------	-------	-------	-------	-------	-------	-------	-------	-------	-------	-------	-------	-------	-------	-------	-------	-------	-------	-------	-------	-------	-------	-------	-------	-------	-------	-------	-------	-------	-------	-------	-------	-------	-------	-------	-------	-------	-------	-------	-------	-------	-------	-------	-------	-------	-------	-------	-------	-------	-------	-------	-------	-------	-------	-------	-------	-------	-------	-------	-------	-------	-------	-------	-------	-------	-------	-------	-------	-------	-------	-------	-------	-------	-------	-------	-------	-------	-------	-------	-------	-------	-------	-------	-------	-------	-------	-------	-------	-------	-------	-------	-------	-------	-------	-------	-------	-------	-------	-------	-------	-------	-------	-------	-------	-------	-------	-------	-------	-------	-------	-------	-------	-------	-------	-------	-------	-------	-------	-------	-------	-------	-------	-------	-------	-------	-------	-------	-------	-------	-------	-------	-------	-------	-------	-------	-------	-------	-------	-------	-------	-------	-------	-------	-------	-------	-------	-------	-------	-------	-------	-------	-------	-------	-------	-------	-------	-------	-------	-------	-------	-------	-------	-------	-------	-------	-------	-------	-------	-------	-------	-------	-------	-------	-------	-------	-------	-------	-------	-------	-------	-------	-------	-------	-------	-------	-------	-------	-------	-------	-------	-------	-------	-------	-------	-------	-------	-------	-------	-------	-------	-------	-------	-------	-------	-------	-------	-------	-------	-------	-------	-------	-------	-------	-------	-------	-------	-------	-------	-------	-------	-------	-------	-------	-------	-------	-------	-------	-------	-------	-------	-------	-------	-------	-----	----	----	----	----	----	----	----	----	----	-----	-----	-----	------	------	-----	-----	-----	-----	-----	-----	-----	-----	-----	-----	-----	-----	-----	-----	-----	-----	-----	------	-------	-------	-------	-------	------	------	------	------	------	------	------	------	------	------	------	------	------	------	------	------	------	------	------	------

• Molecule 103: Dynein axonemal heavy chain 5



A459	K460	Q461	R683	E687	A700	P701	T703	G704	E705	E846	E847	E852	E896	GLU	SER	LYS	ILE	ASN	ASN	GLU	VAL	ASN	TYR	LYS	ASN	GLU	SER	ALA	ARG	GLU	GLY	ASN	PHE	ASP	THR	LEU	THR	SER	SER	ILE	ASN	ALA	ALA	ALA	ALA	M1	F2	R3	I4	G5	R6	R7	Q8	L9	W10	K11	H12	G704	E705	V13	T15	R16	V17	L18	T19	Q20	R21	L22	K23	G24	E25	L95	G96	S97	L98	G99	G100	L4615	G4616	V4617	A4618	Q190	A193	N194	K218	E219	N272	K378	M379	I380	Y381	S382	I383	S384	K452	L453	K454	Q455	M456	P457	N458
------	------	------	------	------	------	------	------	------	------	------	------	------	------	-----	-----	-----	-----	-----	-----	-----	-----	-----	-----	-----	-----	-----	-----	-----	-----	-----	-----	-----	-----	-----	-----	-----	-----	-----	-----	-----	-----	-----	-----	-----	-----	----	----	----	----	----	----	----	----	----	-----	-----	-----	------	------	-----	-----	-----	-----	-----	-----	-----	-----	-----	-----	-----	-----	-----	-----	-----	-----	-----	------	-------	-------	-------	-------	------	------	------	------	------	------	------	------	------	------	------	------	------	------	------	------	------	------	------	------

LEU	LEU	THR	THR	VAL	THR	ARG	LYS	R946	R994	D995	S996	K1059	K1060	I1061	Q1062	E1063	K1064	K1065	M1066	A1067	L1068	L1069	Q1070	S1071	M1072	L1073	D1074	S1075	D1076	K1077	D1078	V1079	L1080	M1081	L1082	E1083	M1084	E1085	L1086	Q1087	D1088	T1089	L1090	E1091	I1092	A1093	S1094	M1095	M1096	L1097	P1098	I1099	P1100	V1101	G1151	K1152	E1153	E1154	A1155	I1156	K1157	T1158	F1159	I1160	T1161	Q1162	P1164	L1165	L1166	S1167	E1168	F1169	E1170	S1171	L1174	I1253	R1254	I1255	A1256	M1257	A1258	A1259	L1260	K1261	E1262	I1263	E1266	S1269	Q1273	P1276	I1277	E1284	Q1344	L1347	D1348	L1351	M1352	M1355	A1356	S1357	G1358	L1359	K1360	M1370	M1373	Q1374	E1390	G1393	L1394	P1395	A1396	L1397	Q1398	Y1399	P1400	L1403	E1404	S1421	V1422	I1423	E1424	T1425	V1426	M1427	S1428	Y1429	Y1430	D1431	I1432	L1433	R1434	S1435	E1436	V1437	M1438	I1439	E1440	K1441	I1442	M1443	M1444	E1445	S1506	L1446	L1447	E1448	F1449	Q1450	M1451	E1512	S1513	C1453	R1454	P1457	R1458	A1459	L1460	K1461	D1462	V1463	Q1464	L1467	D1468	L1469	K1470	K1471	I1472	I1473	D1474	D1475	F1476	S1477	E1478	C1479	C1480	P1481	L1482	L1483	E1484	Y1485	M1486	A1487	S1488	K1489	A1490	M1491	E1492	E1493	R1494	H1495	V1496	E1497	R1498	I1499	T1500	L1501	L1502	T1503	G1504	H1505	S1506	L1507	D1508	V1509	G1510	M1511	E1512	S1513	F1514	K1515	L1516	R1517	A1518	I1519	M1520	A1522	P1523	L1524	L1525	K1526	K1527	K1528	E1529	E1530	I1531	E1532	D1533	I1534	C1535	I1536	S1537	A1538	V1539	K1540	E1541	D1542	D1543	I1544	E1545	V1546	K1547	L1548	K1549	Q1550	M1553	D1556	M1557	K1558	T1559	F1560	T1561	F1562	S1564	F1565	L1566	T1567	R1568	G1569	E1570	L1571	L1572	G1573	R1574	G1575	D1576	S1577	T1578	S1579	E1580	I1581	I1582	A1583	E1586	M1590	G1593	S1594	L1595	L1596	S1597	M1598	F1599	Y1600	M1601	M1602	P1603	F1604	A1606	I1607	Q1607	I1608	Q1609	K1610	Q1613	Y1614	D1620	I1621	I1622	E1623	S1624	M1625	L1626	T1627	V1628	Q1629	M1630	L1631	I1633	Y1634	L1635	E1636	A1637	V1638	F1639	V1640	G1641	G1642	I1643	I1644	A1645	M1646	Q1647	Q1648	L1648	P1649	K1650	I1651	A1652	K1653	R1654	F1655	S1656	M1657	D1658	L1659	S1660	L1661	V1662	V1663	K1664	L1665	M1666	T1667	R1668	A1669	H1670	E1671	V1672	S1673	S1674	V1675	V1676	Q1677	C1678	V1680	G1681	D1682	E1683	L1684	L1685	G1686	Q1687	L1688	L1689	P1690	H1691	L1692	L1693	D1694	Q1695	L1696	E1697	L1698	C1699	Q1700	K1701	G1702	L1703	T1704	G1705	V1706	L1707	E1708	K1709	K1710	R1711	L1712	C1713	F1717	V1720	S1721	D1722	P1723	A1724	L1725	L1726	E1727	L1728	L1729	G1730	Q1731	A1732	S1733	D1734	S1735	H1736	T1737	I1738	Q1739	A1740	H1741	M1744	K1753	F1754	H1755	E1756	K1757	I1758	Y1759	D1760	R1761	T1772	I1773	E1774	L1775	D1776	K1777	P1778	V1779	M1780	A1781	E1782	G1783	M1784	V1785	E1786	V1787	M1788	S1791	E1794	E1795	S1798	S1799	H1801	L1802	V1803	I1804	R1805	Q1806	A1807	A1808	A1809	M1810	I1811	Q1812	E1813	T1814	G1815	F1816	Q1817	E1820	S1824	I1837	R1840	D1841	S1842	E1843	E1844	A1845	L1846	R1847	M1848	A1849	K1850	F1851	D1852	K1853	K1854	I1855	M1856	Q1857	K1858	T1859	A1862	M1906	H1907	I1908	K1909	S1910	P1911	M1912	Y1923	F1924	M1925	E1926	D1927	S1928	D1929	K1930	G1975	G1976	A1977	P1978	A1979	G1980	P1981	A1982	V2003	F2004	M2005	Q2009	M2010	R2013	R2017	C2030	F2031	D2032	E2033	R2036	T2054	K2057	E2058	H2059	K2060	K2061	S2062	F2063	I2064	D2067	G2068	D2069	M2070	L2079	F2080	L2081	T2082	M2083	N2084	P2085	G2086	Y2087	A2088	G2089	E2095	N2096	L2097	K2098	T2099	M2100	F2101	R2102	S2103	V2104	A2105	K2139	L2145	S2146	K2147	V2149	H2150	Y2151	D2152	F2153	G2154	L2155	L2190	S2191	K2192	L2193	L2194	D2195	E2196	D2197	E2198	P2199	L2200	F2201	L2202	S2203	L2204	I2205	E2206	D2207	P2210	M2211	L2212	L2213	K2216	P2220	E2221	L2222	E2223	A2224	A2225	I2226	S2227	R2228	Q2229	V2230	E2231	E2232	A2233	G2234	L2235	L2236	M2237	H2238	P2239	P2240	W2241	K2242	L2243	K2244	V2245	I2246	Q2247	L2248	T2251	H2256	G2257	M2258	M2259	T2260	L2261	G2262	P2263	S2264	G2265	A2266	G2267	K2268	T2269	T2270	C2271	I2272	H2273	T2274	L2275	M2276	R2277	A2278	M2279	T2280	D2281	C2282	G2283	K2284	L2285	P2286	H2286	R2287	E2288	M2289	R2290	M2291	N2292	F2293	K2294	A2295	L2296	T2297	A2298	P2299	Q2300	M2301	F2302	G2303	R2304	L2305	D2306	V2307	T2309	M2310	D2311	W2312	T2313	D2314	G2315	L2316	F2317	S2318	T2319	L2320	W2321	R2322	K2323	T2324	R2326	A2327	K2328	K2329	G2330	E2331	H2332	L2333	W2334	L2335	L2336	L2337	D2338	G2339	P2340	V2341	D2342	A2343	L2344	W2345	L2346	E2347	N2348
-----	-----	-----	-----	-----	-----	-----	-----	------	------	------	------	-------	-------	-------	-------	-------	-------	-------	-------	-------	-------	-------	-------	-------	-------	-------	-------	-------	-------	-------	-------	-------	-------	-------	-------	-------	-------	-------	-------	-------	-------	-------	-------	-------	-------	-------	-------	-------	-------	-------	-------	-------	-------	-------	-------	-------	-------	-------	-------	-------	-------	-------	-------	-------	-------	-------	-------	-------	-------	-------	-------	-------	-------	-------	-------	-------	-------	-------	-------	-------	-------	-------	-------	-------	-------	-------	-------	-------	-------	-------	-------	-------	-------	-------	-------	-------	-------	-------	-------	-------	-------	-------	-------	-------	-------	-------	-------	-------	-------	-------	-------	-------	-------	-------	-------	-------	-------	-------	-------	-------	-------	-------	-------	-------	-------	-------	-------	-------	-------	-------	-------	-------	-------	-------	-------	-------	-------	-------	-------	-------	-------	-------	-------	-------	-------	-------	-------	-------	-------	-------	-------	-------	-------	-------	-------	-------	-------	-------	-------	-------	-------	-------	-------	-------	-------	-------	-------	-------	-------	-------	-------	-------	-------	-------	-------	-------	-------	-------	-------	-------	-------	-------	-------	-------	-------	-------	-------	-------	-------	-------	-------	-------	-------	-------	-------	-------	-------	-------	-------	-------	-------	-------	-------	-------	-------	-------	-------	-------	-------	-------	-------	-------	-------	-------	-------	-------	-------	-------	-------	-------	-------	-------	-------	-------	-------	-------	-------	-------	-------	-------	-------	-------	-------	-------	-------	-------	-------	-------	-------	-------	-------	-------	-------	-------	-------	-------	-------	-------	-------	-------	-------	-------	-------	-------	-------	-------	-------	-------	-------	-------	-------	-------	-------	-------	-------	-------	-------	-------	-------	-------	-------	-------	-------	-------	-------	-------	-------	-------	-------	-------	-------	-------	-------	-------	-------	-------	-------	-------	-------	-------	-------	-------	-------	-------	-------	-------	-------	-------	-------	-------	-------	-------	-------	-------	-------	-------	-------	-------	-------	-------	-------	-------	-------	-------	-------	-------	-------	-------	-------	-------	-------	-------	-------	-------	-------	-------	-------	-------	-------	-------	-------	-------	-------	-------	-------	-------	-------	-------	-------	-------	-------	-------	-------	-------	-------	-------	-------	-------	-------	-------	-------	-------	-------	-------	-------	-------	-------	-------	-------	-------	-------	-------	-------	-------	-------	-------	-------	-------	-------	-------	-------	-------	-------	-------	-------	-------	-------	-------	-------	-------	-------	-------	-------	-------	-------	-------	-------	-------	-------	-------	-------	-------	-------	-------	-------	-------	-------	-------	-------	-------	-------	-------	-------	-------	-------	-------	-------	-------	-------	-------	-------	-------	-------	-------	-------	-------	-------	-------	-------	-------	-------	-------	-------	-------	-------	-------	-------	-------	-------	-------	-------	-------	-------	-------	-------	-------	-------	-------	-------	-------	-------	-------	-------	-------	-------	-------	-------	-------	-------	-------	-------	-------	-------	-------	-------	-------	-------	-------	-------	-------	-------	-------	-------	-------	-------	-------	-------	-------	-------	-------	-------	-------	-------	-------	-------	-------	-------	-------	-------	-------	-------	-------	-------	-------	-------	-------	-------	-------	-------	-------	-------	-------	-------	-------	-------	-------	-------	-------	-------	-------	-------	-------	-------	-------	-------	-------	-------	-------	-------	-------	-------	-------	-------	-------	-------	-------	-------	-------	-------	-------	-------	-------	-------	-------	-------	-------	-------	-------	-------	-------	-------	-------	-------	-------	-------	-------	-------	-------	-------	-------	-------	-------	-------	-------	-------	-------	-------	-------	-------	-------	-------	-------	-------	-------	-------	-------	-------	-------	-------	-------	-------	-------	-------	-------	-------	-------	-------	-------	-------	-------	-------	-------	-------	-------	-------	-------	-------	-------	-------	-------	-------	-------	-------	-------	-------	-------	-------	-------	-------	-------	-------	-------	-------	-------	-------	-------	-------	-------	-------	-------	-------	-------	-------	-------	-------	-------	-------	-------	-------	-------	-------	-------	-------	-------	-------	-------	-------	-------	-------	-------	-------	-------	-------	-------	-------	-------	-------	-------	-------	-------	-------	-------	-------	-------	-------	-------	-------	-------	-------	-------	-------	-------	-------	-------	-------	-------	-------	-------	-------	-------	-------	-------	-------	-------	-------	-------	-------	-------	-------	-------	-------	-------	-------	-------	-------	-------	-------	-------	-------	-------	-------	-------	-------	-------	-------	-------	-------	-------	-------	-------	-------	-------	-------	-------	-------	-------	-------	-------	-------	-------	-------	-------	-------	-------	-------	-------	-------	-------	-------	-------	-------	-------	-------	-------	-------	-------	-------	-------	-------

L2349 N2350	L2359 L2360 L2361 L2362 L2363 L2364 L2365 L2366 L2367 L2368 L2369 L2370 L2371 L2372 C2373 C2374 L2375 L2376 L2377 E2378 P2379 P2379 H2380 L2381 L2382 L2383 L2384 L2385 S2386 P2387 A2388 T2389 V2390	N2393 G2394 L2395 V2396 F2397 H2398 S2399 S2400 S2401 L2402 L2403 D2404 W2405 S2406 P2407 L2408 L2409 E2410 G2411 F2412 L2413 R2414 K2415 R2416
S2417 P2418 Q2419 E2420 A2421 E2422 L2423 L2424 R2425 Q2426 L2427 Y2428 T2429 E2430 S2431 F2432 P2433 D2434 L2435 Y2436 R2437 F2438 C2439 I2440 Q2441 N2442 L2443 E2444 Y2445 K2446 M2447 E2448 V2449 E2451 A2452 F2453 W2454 I2455 T2456 Q2457 S2458 S2459 S2460 N2461 M2462 L2462 Q2463 G2464 L2465 S2466 P2467 L2468 K2469 E2470 Q2471 G2472 E2473 V2475 S2476		
Q2477 A2478 H2479 L2480 G2481 R2482 L2483 F2484 V2485 P2486 A2487 L2488 W2489 S2491 A2492 G2493 A2494 A2495 L2496 E2497 A2500 D2499 G2500 R2501 R2502 R2503 L2504 E2505 L2506 W2507 L2508 R2509 S2510 R2511 P2512 L2513 G2514 T2515 L2516 E2517 P2519 P2520 P2521 A2522 G2523 P2524 L2525 D2526 T2527 A2528 F2529 D2530 Y2531 Y2532 A2533 P2535 D2536		
G2537 T2538 W2539 T2540 H2541 W2542 N2543 V2567 D2568 N2569 V2570 R2571 T2572 D2573 F2574 L2575 Q2577 T2578 L2579 A2580 K2581 Q2582 G2583 K2584 A2585 V2586 L2587 L2589 G2590 E2591 K2596 L2599 I2600 K2601 G2602 F2603 M2604 S2605 K2606 Y2607 D2608 P2609 E2610 C2611 H2612 M2613 I2614 S2621 A2622 T2631 V2635		
P2647 A2648 G2649 K2650 K2651 M2652 T2653 V2654 V2659 N2660 M2661 P2662 L2663 L2664 N2665 E2666 W2667 G2668 D2669 Q2670 V2671 E2681 Y2686 N2687 K2690 P2691 G2692 L2700 Q2701 F2702 L2703 A2704 A2705 M2706 H2708 P2709 G2710 G2711 G2712 R2713 N2714 L2715 L2716 P2717 Q2718 R2719 L2720 K2721 R2722 Q2723 F2724 S2725 I2726 F2727		
N2728 C2729 T2730 L2731 R2732 S2733 C2750 T2751 Q2752 R2753 G2754 T2755 S2756 E2757 R2772 Q2775 N2776 T2777 K2778 L2779 K2780 N2781 L2782 P2783 T2784 P2785 V2791 S2809 E2810 V2811 L2812 K2813 E2814 A2846 L2849 V2850 E2852 E2853 E2854 T2855 G2856 E2857 E2858 K2859 K2860 L2861 L2862 V2863 D2864 C2865 L2866 L2867		
F2874 L2875 R2876 D2877 A2878 P2879 E2880 A2881 A2882 G2883 E2884 L2885 S2886 E2887 A2889 D2890 T2893 P2894 E2898 P2899 I2900 F2903 S2904 H2905 L2906 K2907 E2908 R2909 L2910 M2911 M2912 F2913 L2914 Q2915 Y2917 S2849 L2850 V2851 E2852 E2853 E2854 T2855 G2856 E2857 E2858 K2859 K2860 L2861 L2862 V2863 D2864 C2865 L2866 L2867		
T2981 L2982 T2983 R2984 S2985 Y2986 N2987 T2988 S2989 N2990 L2991 M2992 E2993 D2994 L2995 K2996 V2997 Y2999 R3000 T3001 Q3004 Q3005 K3019 D3020 E3021 S3022 F3023 L3024 E3025 Y3026 M3038 L3039 F3040 A3041 R3042 D3043 E3044 I3045 D3046 E3047 I3048 N3049 S3050 D3051 L3052 A3053 S3054 V3055 M3056 K3057 K3058 A2973 F3060 P3061 F3065		
T3066 N3067 E3068 N3069 L3070 K3071 D3072 Y3073 F3074 G3092 E3093 K3094 F3095 N3096 R3097 R3098 A3099 L3100 K3101 F3102 P3103 E3127 H3128 F3129 L3130 T3131 S3132 Y3133 D3134 I3135 D3136 C3137 S3138 L3139 E3140 I3141 K3142 K3143 G3190 E3191 K3192 H3193 V3194 E3195 V3196 L3197 T3198 L3199 A3200 N3201 K3202 R3203 N3204 K3263 D3264 G3265 L3207 E3208		
K3209 L3210 K3211 E3212 A3213 S3214 E3215 S3216 V3217 A3218 A3219 L3220 S3221 K3222 E3223 L3224 A3225 A3226 K3227 E3228 K3229 E3230 L3231 Q3232 V3233 N3235 D3236 K3237 A3238 D3239 K3240 V3241 L3242 K3243 E3244 T3245 M3247 K3248 A3249 Q3250 A3251 A3252 E3253 K3254 P3255 K3256 A3257 L3258 V3259 Q3260 K3261 V3262 K3263 D3264 A3265 L3207 E3208		
I3269 V3270 D3271 S3272 L3273 S3274 K3275 D3276 K3277 A3278 L3279 A3280 E3281 G3282 K3283 L3284 E3285 A3286 A3287 K3288 P3289 A3290 L3291 E3292 E3293 A3294 E3295 A3296 A3297 L3298 Q3299 T3300 I3301 P3302 P3303 S3304 D3305 L3306 A3307 T3308 V3309 R3310 T3311 L3312 G3313 R3314 P3315 P3316 H3317 L3318 I3319 M3320 R3321 L3322 M3323 D3324 C3325 S3326 L3327 L3328		
L3329 F3330 Q3331 R3332 K3333 V3334 S3335 A3336 V3337 K3338 I3339 D3340 L3341 E3342 K3343 S3344 G3345 T3346 M3347 P3348 S3349 V3350 Q3351 E3352 S3353 L3354 K3355 L3356 M3357 T3358 A3359 G3360 N3361 F3362 L3363 Q3364 N3365 L3366 Q3367 K3368 F3369 P3370 K3371 D3372 T3373 I3374 N3375 E3376 E3377 V3378 I3379 E3380 F3381 L3382 S3383 P3384 Y3385 F3386 E3387 M3388		
P3389 D3390 Y3391 N3392 L3393 E3394 T3395 A3396 K3397 R3398 V3399 C3400 G3401 N3402 V3403 A3404 G3405 C3407 S3408 N3409 T3410 K3411 A3412 M3413 S3415 F3416 F3417 S3418 I3419 N3420 K3421 E3422 V3423 L3424 P3425 L3426 K3427 A3428 N3429 L3430 V3431 V3432 Q3433 N3435 R3436 H3437 L3438 L3439 A3440 K3441 Q3442 D3443 P3444 K3445 F3446 E3447 Q3448		

A3449	A3450	L3451	I3452	D3453	K3454	K3455	A3456	E3457	L3458	D3459	V3460	V3461	A3462	A3463	E3464	V3465	K3466	K3467	A3468	K3469	T3470	E3471	K3472	K3473	K3474	L3475	L3476	E3477	D3478	A3479	E3480	R3481	C3482	R3483	H3484	K3485	K3486	K3487	T3488	A3489	S3490	T3491	L3492	L3493	S3494	G3495	L3496	A3497	E3499	K3500	E3501	K3502	K3503	T3504	E3505	S3507	D3508					
E3509	F3510	A3511	A3512	Q3513	T3514	K3515	R3516	K3551	A3552	R3553	K3554	I3555	P3556	K3559	I3568	D3569	A3570	P3571	T3572	I3573	S3574	E3575	W3576	N3577	L3578	Q3579	I3604	D3605	P3606	E3607	T3608	K3611	I3612	K3615	N3616	K3617	E3618	S3619	R3620	N3621	E3622	L3623	Q3624	L3625	T3626	S3627	N3628	L3629	H3630	K3631	Y3632	F3633	R3634									
N3635	H3636	L3637	E3638	D3639	S3640	L3641	S3642	L3643	G3644	R3645	P3646	L3647	L3648	E3650	D3651	V3652	G3653	E3654	E3655	L3656	D3657	P3658	A3659	L3660	D3661	N3662	N3667	F3668	I3669	K3670	L3671	G3672	S3673	L3674	F3675	K3676	V3677	K3678	V3679	G3680	D3681	K3682	E3683	V3684	D3685	V3686	L3688	L3687	S3689	D3688	G3689	F3690	L3692	L3693	T3695	T3696	K3697					
L3699	P3699	N3700	P3701	A3702	V3703	T3717	G3729	R3730	S3731	L3732	L3733	T3734	E3735	K3736	Q3737	E3738	L3739	E3740	K3741	E3742	L3743	T3744	H3745	L3746	D3747	E3748	D3749	V3750	T3751	A3752	N3753	K3754	R3755	R3756	N3757	K3758	E3759	L3760	E3761	D3762	N3763	D3764	L3765	L3766	R3767	L3768	T3769	S3770	T3771	Q3772	G3773	F3774	L3775	V3776	E3777	D3778	E3779					
L3781	I3782	V3783	V3784	L3785	S3786	N3787	L3788	K3789	R3790	T3791	A3792	E3793	E3794	V3795	K3796	Q3797	K3798	L3799	E3800	L3801	S3802	A3803	E3804	T3805	E3806	V3807	L3808	L3809	N3810	S3811	A3812	R3813	E3814	E3815	V3816	R3817	P3818	V3819	D3852	L3853	S3854	L3855	A3856	K3857	S3858	V3859	K3860	S3861	P3862	I3863	T3864	S3865	T3866	L3867	S3868	G3869	F3890	L3892	L3893	T3895	T3896	K3897
I3871	K3885	G3886	L3887	V3888	E3889	E3890	K3891	K3892	F3893	D3904	R3907	N3908	R3909	V3910	K3911	H3912	E3913	E3914	F3915	L3916	T3917	L3918	L3919	E3920	G3921	G3922	A3923	S3924	L3925	D3926	L3927	K3928	A3929	C3930	P3931	P3932	K3933	P3934	S3935	K3936	W3937	L3938	L3939	D3940	I3941	T3942	W3943	L3944	N3945	L3946	V3947	L3948	L3949	S3950	K3951	L3952						
R3953	Q3954	F3955	S3956	D3957	L3958	L3959	D3960	Q3961	I3962	S3963	R3964	N3965	E3966	K3967	M3968	K3969	V3970	I3971	V3972	E3973	D3974	K3975	E3976	N3977	P3978	E3979	E3980	E3981	P3982	L3983	P3984	N3985	Y3987	D3988	K3989	S3990	L3991	D3992	C3993	P3994	R3995	K3996	L3997	L3998	L3999	I4000	R4001	A4002	W4003	C4004	P4005	D4006	L4007	T4008	I4009	A4010	Q4011	A4012				
R4013	K4014	Y4015	L4016	V4017	D4018	S4019	M4020	G4021	E4022	K4023	Y4024	A4025	E4026	G4027	V4028	L4029	L4030	D4031	L4032	E4033	K4034	T4035	W4036	E4037	E4038	S4039	D4040	P4041	R4042	T4043	P4044	L4045	L4046	C4047	L4048	L4049	S4050	M4051	G4052	S4053	D4054	P4055	T4056	D4057	S4058	L4059	L4060	A4061	L4062	G4063	K4064	R4065	L4066	K4067	L4068	E4069	T4070	R4071	Y4072			
Y4073	S4074	M4075	Q4079	E4080	V4081	H4082	A4083	R4084	K4085	L4086	Q4088	Q4089	T4090	M4091	A4092	M4093	G4094	A4095	W4096	A4097	L4098	L4099	Q4100	M4101	A4102	H4103	D4107	F4108	M4109	L4110	E4111	L4112	M4113	D4114	I4115	I4116	I4117	E4118	T4119	E4120	L4121	L4122	H4123	D4124	A4125	F4126	R4127	L4128	W4129	M4130	T4131	T4132	E4133	K4136								
P4139	L4142	M4145	S4146	T4147	K4148	L4149	A4150	M4151	D4152	P4154	Q4155	G4156	R4158	A4159	G4160	L4161	K4162	R4163	T4164	Y4165	S4166	G4167	W4168	A4169	Q4170	D4171	L4172	L4173	L4174	V4175	S4176	L4177	G4178	S4179	Q4180	W4181	K4182	M4184	L4185	Y4186	A4187	V4188	L4189	P4190	L4191	H4192	S4193	T4194	V4195	Q4196	E4197	R4198	R4199	K4200								
F4201	G4202	A4203	L4204	G4205	W4206	M4207	L4208	P4209	Y4210	E4211	F4212	M4213	Q4214	A4215	D4216	F4217	N4218	A4219	T4220	W4221	L4228	D4229	D4230	M4231	D4232	V4233	K4234	K4235	G4236	V4237	S4238	W4239	Q4250	Y4251	G4252	G4253	R4254	V4255	L4256	D4257	D4258	Y4259	D4260	K4261	R4262	L4263	L4264	M4265	T4266	F4267	A4268	K4269	W4270	W4271	F4272	S4273	E4274					
M4275	M4276	F4277	G4278	P4279	D4280	F4281	S4282	F4283	Y4284	Q4285	G4286	M4287	N4288	I4289	P4290	K4291	C4292	S4293	T4294	V4295	D4296	M4297	Y4298	L4299	Q4300	Y4301	I4302	K4303	S4304	L4305	P4306	Y4307	S4308	D4309	S4310	P4311	E4312	V4313	F4314	G4315	L4316	H4317	P4318	M4319	A4320	D4321	I4322	T4323	Y4324	Q4325	S4326	K4327	L4328	A4329	K4330	D4331	W4332	L4333	D4334			
L4337	G4346	G4347	G4348	D4349	E4350	A4354	A4357	R4358	L4359	A4360	D4361	D4362	M4363	L4364	K4366	L4367	P4368	P4369	D4370	Y4371	V4372	P4373	Y4374	E4375	V4376	K4377	E4378	R4379	L4380	Q4381	K4382	M4383	G4384	P4385	F4386	Q4387	P4388	M4389	M4390	I4391	F4392	Q4401	R4402	V4403	L4404	S4405	L4406	V4407	R4408	S4409	T4410	L4411	T4412									

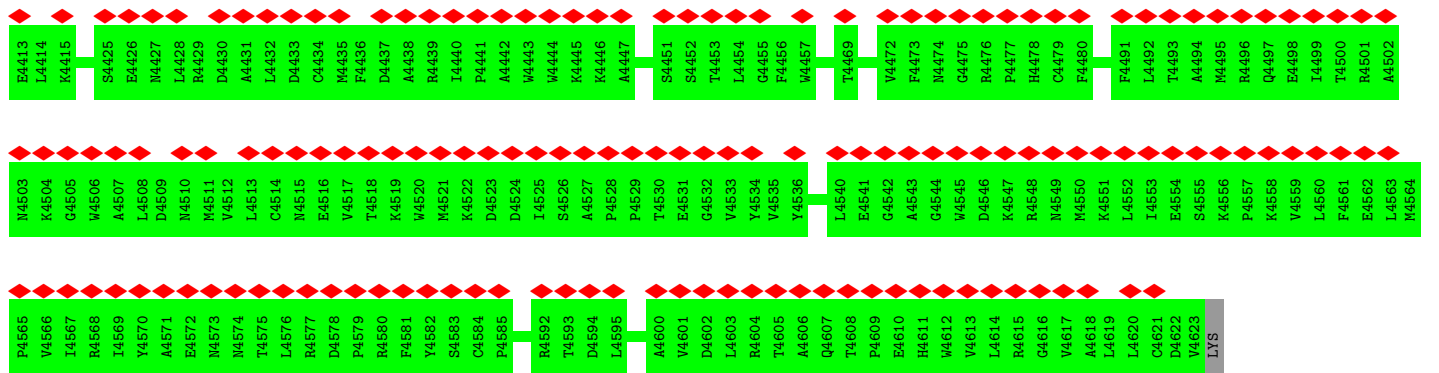

● Molecule 103: Dynein axonemal heavy chain 5

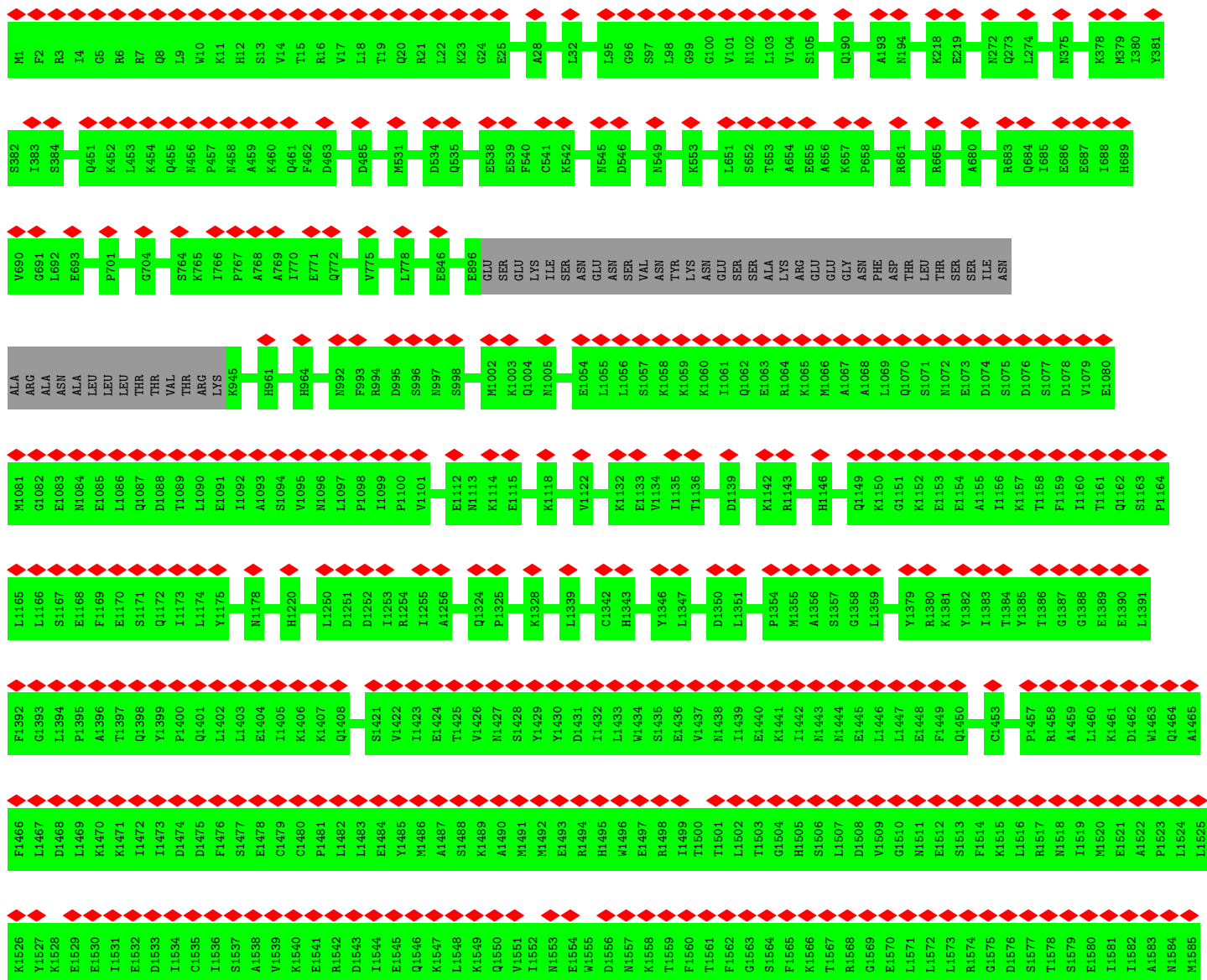

E1586	E1587	S1588	L1589	M1590	L1591	L1592	G1593	S1594	L1595	L1596	S1597	M1598	R1599	Y1600	M1601	M1602	P1603	F1604	K1605	A1606	Q1607	I1608	V1612	L1615	S1616	M1617	S1618	T1619	D1620	I1621	I1622	E1623	S1624	M1625	M1626	I1627	V1628	Q1629	M1630	L1631	W1632	I1633	Y1634	L1635	E1636	A1637	V1638	F1639	V1640	G1641	G1642	D1643	I1644	A1645	K1646	Q1647	L1648																																																						
P1649	K1650	E1651	A1652	K1653	R1654	F1655	S1656	M1657	I1658	D1659	K1660	S1661	V1662	V1663	K1664	I1665	M1666	T1667	R1668	A1669	H1670	E1671	V1672	P1673	S1674	V1675	V1676	Q1677	C1678	C1679	V1680	G1681	D1682	E1683	T1684	L1685	G1686	L1687	L1688	L1689	P1690	H1691	W1692	L1693	D1694	Q1695	L1696	E1697	V1698	F1699	Q1700	K1701	S1702	L1703	T1704	G1705	Y1706	S1721																																																					
D1722	P1723	A1724	L1725	L1726	E1727	F1754	H1755	E1756	K1757	I1758	Y1759	D1760	E1774	L1775	D1776	K1777	V1779	M1780	S1798	S1799	L1800	H1801	L1802	V1803	I1804	R1805	Q1806	A1807	A1808	A1809	M1810	I1811	Q1812	E1813	T1814	G1815	F1816	Q1817	L1818	E1820	F1821	L1822	S1823	S1824	F1825	G1833	M1836	I1837	W1838	L1839	R1840	D1841	L1842	E1843	E1844	A1845	L1846	R1847	M1848	A1849	K1850	F1851	D1852	K1853	K1854	I1855	M1856	Q1857	K1858	T1859	M1860	Q1861	A1862	F1863	L1864	E1865	L1866	D1901	D1902	L1903	C1904	H1905	M1906	H1907	I1908	K1909	S1910	P1911	M1912	D1913	F1914	E2092	L2093	P2094	E2095	N2096	L2097	K2098	L2099	M2100	F2101	D2126	N2127	V2128	V2129	L2130	A2131	R2132	K2133	F2134	G1980
S1842	E1843	E1844	A1845	L1846	R1847	M1848	A1849	K1850	F1851	D1852	K1853	K1854	I1855	M1856	Q1857	K1858	T1859	M1860	Q1861	A1862	F1863	L1864	E1865	L1866	D1901	D1902	L1903	C1904	H1905	M1906	H1907	I1908	K1909	S1910	P1911	M1912	D1913	F1914	E2092	L2093	P2094	E2095	N2096	L2097	K2098	L2099	M2100	F2101	D2126	N2127	V2128	V2129	L2130	A2131	R2132	K2133	F2134	G1980																																																					
P1981	A1982	G1983	S2007	D2008	Q2009	G2014	L2015	G2016	R2017	I2018	F2019	E2033	F2034	N2035	R2036	I2037	L2042	S2043	V2044	A2045	A2046	Q2047	Q2048	I2049	S2050	M2083	P2085	G2086	Y2087	A2088	G2089	R2090	Q2091	E2092	L2093	P2094	E2095	N2096	L2097	K2098	L2099	M2100	F2101	D2126	N2127	V2128	V2129	L2130	A2131	R2132	K2133	F2134	G1980																																																										
F2135	T2136	L2137	Y2138	L2139	L2140	C2141	E2142	E2143	Q2144	L2145	S2146	K2147	Q2148	V2149	H2150	Y2151	T2176	E2177	S2178	T2179	L2180	V2181	R2182	R2183	V2184	L2185	L2186	D2187	N2188	L2189	L2190	S2191	L2192	L2193	L2194	D2195	E2196	D2197	E2198	F2199	L2200	F2201	L2202	S2203	K2204	L2205	E2206	D2207	F2209	P2210	N2211	L2212	L2213	L2214	D2215	K2216	A2217																																																						
G2218	Y2219	P2220	E2221	L2222	E2223	A2224	A2225	L2226	S2227	R2228	P2229	Q2229	V2230	E2231	E2232	A2233	G2234	L2235	I2236	N2237	H2238	P2239	P2240	W2241	K2242	K2244	T2245	I2246	L2248	F2249	R2253	G2257	M2258	M2259	T2260	L2261	G2262	P2263	S2264	G2265	G2266	G2267	K2268	T2269	T2270	C2271	I2272	H2273	T2274	L2275	M2276	L2277	L2278	D2279	T2280	D2281																																																							
C2282	K2284	P2285	H2286	R2287	E2288	M2289	R2290	M2291	M2292	P2293	K2294	A2295	L2296	T2297	A2298	P2299	Q2300	M2301	F2302	G2303	R2304	L2305	V2306	A2308	T2309	D2310	W2312	T2313	G2315	L2316	F2317	S2318	T2319	L2320	W2321	R2322	K2323	T2324	L2325	R2326	A2327	K2328	K2329	G2330	E2331	H2332	L2333	W2334	L2335	T2336	L2337	D2338	G2339	P2340	V2341																																																								
D2342	A2343	L2344	W2345	L2346	E2347	M2348	L2349	M2350	S2351	V2352	L2353	L2359	T2360	L2361	A2362	N2363	G2364	D2365	R2366	L2367	M2372	C2373	K2374	L2375	L2376	F2377	E2378	P2379	H2380	M2381	L2382	D2383	N2384	A2385	S2386	F2387	A2388	T2389	V2390	M2393	G2394	M2395	V2396	F2397	M2398	S2399	S2400	S2401	L2402	L2403	D2404	W2405	S2406	P2407	L2408	L2409																																																							
E2410	G2411	F2412	L2413	K2414	K2415	R2416	S2417	P2418	Q2419	E2420	A2421	E2422	I2423	L2424	R2425	Q2426	L2427	Y2428	T2429	E2430	S2431	F2432	P2433	D2434	L2435	Y2436	R2437	F2438	G2439	I2440	Q2441	M2442	L2443	E2444	Y2445	K2446	M2447	E2448	V2449	L2450	E2451	A2452	F2453	V2454	I2455	T2456	Q2457	S2458	M2460	M2461	L2462	Q2463	G2464	L2465	I2466	L2468	K2469																																																						
E2470	Q2471	G2472	G2473	E2474	V2475	S2476	Q2477	A2478	H2479	L2480	G2481	R2482	L2483	F2484	V2485	F2486	A2487	L2488	L2489	M2490	S2491	A2492	G2493	A2494	L2496	E2497	L2498	D2499	G2500	R2501	R2502	L2503	L2504	E2505	L2506	W2507	L2508	R2509	S2510	R2511	P2512	T2513	G2514	T2515	L2516	E2517	L2518	P2519	P2520	P2521	A2522	G2523	P2524	G2525	D2526	A2528	F2529																																																						
D2530	Y2531	Y2532	V2533	A2534	P2535	D2536	G2537	T2538	W2539	T2540	H2541	W2542	N2543	T2544	R2545	T2546	Q2547	E2548	P2565	N2566	V2567	D2568	N2569	V2570	R2571	T2572	F2574	L2575	Q2577	T2578	I2579	A2580	K2581	Q2582	G2583	K2584	A2585	V2586	L2587	L2588	L2589	G2590	E2591	Q2592	G2593	T2594	A2595	K2596	T2597	V2598	I2599	K2600	G2601	G2602	F2603	M2604																																																							
S2605	K2606	Y2607	D2608	P2609	E2610	C2611	M2613	L2614	K2615	S2616	L2617	N2618	F2619	S2620	S2621	T2622	T2623	I2632	Y2635	V2636	D2637	K2638	R2639	M2640	G2641	T2642	T2643	Y2644	G2645	P2646	T2647	A2648	G2649	K2650	K2651	M2652	K2654	A2655	F2656	L2657	D2658	V2659	N2660	M2661	T2662	L2663	L2664	N2665	E2666	M2667	G2668	D2669	Q2670	V2671	T2672																																																								

G2673	G2674	G2675	G2676	G2677	G2678	G2679	G2680	G2681	G2682	G2683	G2684	G2685	G2686	G2687	G2688	G2692	E2693	F2694	T2695	S2696	I2697	D2698	D2699	I2700	Q2701	F2702	L2703	A2704	A2705	A2706	I2707	H2708	F2709	G2710	G2711	G2712	R2713	H2714	D2715	I2716	F2717	Q2718	R2719	L2720	K2721	R2722	Q2723	F2724	S2725	I2726	F2727	H2728	C2729	L2730	L2731	P2732	S2733	E2734	
A2736	S2736	V2737	D2738	Q2752	R2753	F2754	F2755	S2756	E2757	E2758	V2759	R2760	D2761	K2765	L2766	V2767	P2768	L2769	T2770	R2771	R2772	L2773	W2774	Q2775	M2776	T2777	K2778	A2779	K2780	M2781	L2782	P2783	T2784	P2785	A2786	K2787	F2788	H2789	Y2790	V2791	F2792	N2793	L2794	E2810	K2813	E2814	S2815	N2816	K2823	C2826	I2830	A2831							
F2834	S2837	S2838	D2839	V2840	T2841	W2842	F2843	D2844	K2845	A2846	L2847	V2848	S2849	L2850	V2851	E2852	E2853	E2854	F2855	G2856	E2857	E2858	K2859	K2860	L2861	V2863	D2864	S2865	G2866	L2867	L2875	R2876	D2877	A2878	P2879	E2880	A2881	A2882	G2883	E2884	T2885	S2886	D2890	A2891	F2903	S2904	H2905	E2908	R2909	M2912									
Q2915	L2916	E2919	S2920	I2921	R2922	S2985	Y2986	M2987	T2988	S2989	M2990	E2993	I3018	K3019	D3020	E3021	S3022	L3024	E3025	S3032	A3041	R3042	D3043	E3044	I3045	D3046	E3047	I3048	N3049	S3054	K3058	T3066	N3067	E3068	N3069	L3070	H3071	D3072	E3093	K3094	F3095	R3096	N3097	R3098	A3099	K3101	L3100	K3101	F3102										
P3103	A3104	L3105	L3106	S3107	T3131	D3136	C3137	L3138	S3139	E3140	I3141	K3142	K3143	E3144	R3197	T3198	L3199	A3200	N3201	R3202	M3203	N3204	T3205	G3206	E3208	K3209	L3210	K3211	E3212	S3214	E3215	S3216	V3217	A3218	A3219	L3220	S3221	K3222	E3223	L3224	E3225	A3226	K3227	K3228	E3229	E3230	L3231	Q3232	V3233	A3234	N3235	D3236	K3237	A3238					
D3239	K3240	V3241	L3242	E3244	V3245	T3246	K3247	K3248	A3249	Q3250	K3251	A3252	E3253	K3254	V3255	K3256	A3257	E3258	V3259	Q3260	K3261	V3262	K3263	D3264	R3265	A3266	Q3267	A3268	I3269	V3270	D3271	S3272	L3273	S3274	K3275	D3276	K3277	A3278	I3279	L3280	E3281	E3282	K3283	L3284	E3285	A3286	A3287	K3288	P3289	V3290	L3291	E3292	E3293	A3294	E3295	L3296	A3297	L3298	
Q3299	T3300	I3301	R3302	P3303	S3304	D3305	I3306	A3307	T3308	V3309	R3310	T3311	L3312	G3313	R3314	P3315	R3316	H3317	L3318	I3319	M3320	R3321	I3322	M3323	C3324	C3325	V3326	E3327	L3328	L3329	K3330	Q3331	K3332	K3333	V3334	S3335	A3336	V3337	K3338	I3339	C3340	G3341	N3342	V3343	A3344	S3345	T3346	M3347	P3348	S3349	V3350	Q3351	S3352	S3353	L3354	K3355	L3356	M3357	T3358
A3359	G3360	N3361	F3362	L3363	Q3364	N3365	L3366	Q3367	Q3368	F3369	P3370	K3371	D3372	T3373	I3374	N3375	E3376	E3377	V3378	I3379	E3380	F3381	L3382	S3383	P3384	Y3385	F3386	E3387	M3388	P3389	D3390	Y3391	N3392	L3393	E3394	T3395	A3396	K3397	R3398	V3399	C3400	G3401	N3402	V3403	A3404	G3405	L3406	C3407	S3408	W3409	T3410	K3411	A3412	M3413	A3414	S3415	F3416	F3417	S3418
I3419	N3420	K3421	E3422	V3423	L3424	P3425	L3426	K3427	A3428	N3429	L3430	V3431	V3432	Q3433	E3434	N3435	R3436	H3437	L3438	L3439	A3440	M3441	Q3442	D3443	L3444	Q3445	K3446	Q3447	Q3448	A3449	E3450	L3451	D3452	D3453	K3454	Q3455	A3456	E3457	L3458	D3459	V3460	V3461	Q3462	A3463	E3464	Y3465	E3466	Q3467	A3468	M3469	T3470	E3471	K3472	Q3473	T3474	L3475	L3476	E3477	D3478
A3479	E3480	R3481	C3482	K3483	H3484	K3485	K3486	Q3487	T3488	A3489	S3490	T3491	L3492	L3493	S3494	G3495	L3496	A3497	G3498	E3499	K3500	E3501	R3502	W3503	T3504	E3505	Q3506	S3507	Q3508	E3509	F3510	A3511	A3512	Q3513	T3514	K3515	R3516	N3544	D3545	M3546	G3547	K3548	E3549	M3550	K3551	A3552	R3553	K3554	I3555	P3556	F3557	G3558	K3559	M3560	L3602	L3603	I3604		
D3605	T3608	Q3609	G3610	K3611	L3612	W3613	L3614	K3615	R3620	L3623	Q3624	L3625	T3626	S3627	N3629	H3630	K3631	Y3632	F3633	R3634	M3635	H3636	L3637	E3638	S3639	S3640	L3641	S3642	L3643	G3644	R3645	P3646	L3647	L3648	I3649	E3650	D3651	V3652	G3653	E3654	E3655	L3656	D3657	P3658	A3659	L3660	K3670	T3671	G3672	S3673	K3676	V3677	K3678						
V3679	G3680	D3681	K3682	E3683	V3684	D3685	L3692	Y3693	I3694	E3695	T3696	K3697	L3698	A3702	F3716	L3728	V3731	I3732	L3733	T3734	E3735	K3736	Q3737	E3738	L3739	E3740	K3741	E3742	R3743	T3744	H3745	L3746	M3747	E3748	D3749	V3750	T3751	A3752	N3753	K3754	R3755	R3756	M3757	K3758	E3759	L3760	E3761	R3762	N3763	L3764	L3765	Y3766	R3767	L3768					
T3769	S3770	T3771	Q3772	G3773	S3774	L3775	V3776	E3777	R3778	E3779	S3780	L3781	L3782	V3784	L3785	S3786	R3787	T3788	K3789	R3790	T3791	A3792	E3793	E3794	V3795	T3796	Q3797	K3798	L3799	E3800	S3801	L3802	A3803	E3804	T3805	E3806	V3807	Q3808	N3810	S3811	A3812	R3813	E3815	Y3816	R3817	E3818	V3819	A3820	T3821	R3822	K3833	R3834	L3835	V3836	N3837				

E3838	E3916	E3976	E4036	L4099	D4174	G4236	D4296	V4356	I4418	L4492	L4552
H3839	T3917	N3977	E4037	Q4100	V4175	V4237	M4297	A4357	D4419	T4493	I4553
Y3840	L3918	P3978	E4038	M4101	S4176	S4238	Y4298	R4358	G4420	A4494	E4554
S3858	I3919	E3979	S4039	C4102	S4177	W4239	L4299	L4359	T4421	M4495	S4555
V3859	K3920	E3980	D4040	H4103	G4178	T4241	Q4300	A4360	S4425	R4496	K4556
K3860	G3921	P3982	P4041	D4110	S4179	I4242	Y4301	D4362	E4426	Q4497	P4557
S3861	G3922	L3983	P4044	D4114	Q4180	R4243	I4302	M4363	M4427	E4498	K4558
I3862	A3923	L3984	L4045	I4115	W4181	Y4244	Q4303	L4364	L4428	T4499	V4559
I3863	S3924	P3985	I4046	I4116	P4182	M4245	S4304	E4365	R4429	T4500	L4560
I3864	L3925	A3986	C4047	I4117	P4183	M4246	L4305	L4366	D4430	A4502	F4561
S3865	D3926	A3987	L4048	E4118	L4185	G4247	P4306	K4366	A4431	A4503	E4562
S3866	L3927	Y3987	L4049	E4119	L4186	E4248	A4307	L4367	L4432	M4503	L4563
K3867	K3928	D3988	L4050	T4119	Y4186	E4249	Y4308	P4368	D4433	K4504	M4564
I3868	A3929	S4050	M4051	E4120	W4188	I4249	D4309	P4369	C4434	G4505	P4565
A3869	C3930	G4052	M4052	L4121	V4188	Q4250	S4310	D4370	M4435	W4506	V4566
K3870	P3931	L3991	S4053	W4122	A4189	Y4251	P4311	Y4371	F4436	A4507	I4567
I3871	P3932	C3993	D4054	H4123	F4190	G4252	E4312	P4372	D4437	L4508	I4568
I3872	Y3934	F3994	P4055	D4124	L4191	G4253	Y4313	W4373	A4438	D4509	I4569
E3873	P3935	R3995	T4056	D4125	H4192	R4254	F4314	F4374	R4439	M4510	Y4570
H3874	K3936	R3996	D4057	F4126	S4193	Y4255	G4315	E4375	W4443	M4511	A4571
Y3877	W3937	L3997	S4058	R4127	W4194	D4257	L4316	K4376	K4443	V4512	E4572
Y3880	I3938	L3998	I4059	W4128	W4195	D4258	H4317	E4378	L4454	L4513	M4573
K3881	L3939	L3999	I4060	M4130	Q4196	D4259	P4318	E4379	G4455	C4514	M4574
Y3882	D3940	I4000	A4061	T4131	R4198	K4260	A4320	R4379	G4455	M4515	T4575
A3883	I3941	R4001	L4062	T4132	R4199	R4262	D4321	Q4381	F4458	E4516	L4576
A3884	T3942	S4002	G4063	E4133	R4200	R4263	I4322	K4382	T4459	T4518	D4578
R3885	W3943	W4003	K4064	A4134	K4200	L4263	T4323	M4383	A4460	K4519	P4579
G3886	C4004	C4004	L4065	H4135	F4201	L4264	Y4324	G4384	L4461	W4520	R4580
L3887	N3944	P4005	L4066	H4136	G4202	T4266	Q4325	F4385	I4462	K4521	F4581
Y3888	L3946	D4006	K4067	Q4137	L4204	T4267	S4326	F4386	R4464	K4522	Y4582
E3889	V3947	R4007	I4068	I4147	G4205	F4267	K4327	Q4387	M4465	D4523	S4583
H3891	E3948	T4008	E4069	K4148	W4206	A4268	L4328	P4388	M4466	D4524	C4584
K3892	L3949	I4009	T4070	F4149	R4207	K4269	A4329	M4389	S4466	D4525	P4585
F3893	S3950	A4010	R4071	A4150	L4208	A4269	L4330	M4390	Q4467	S4526	I4586
F3895	Q4011	Q4011	Y4073	A4151	P4209	W4271	D4331	I4391	T4469	A4527	Y4597
T3896	L3952	R4013	S4074	D4152	E4210	F4272	Y4332	F4392	S4470	P4528	I4598
L3897	Q3954	A4014	M4075	D4153	F4212	E4274	L4333	L4393	W4471	M4529	A4599
L3898	F3955	Y4015	Q4079	P4154	Q4214	E4276	D4334	R4394	W4472	T4530	A4600
L3899	S3956	I4016	E4080	Q4155	M4213	M4276	T4335	Q4395	F4473	E4531	V4601
T3900	S3957	D4018	W4081	G4156	Q4215	M4276	F4277	E4396	M4474	G4532	D4602
K3901	V3958	D4019	H4082	G4157	A4215	G4278	F4278	I4397	G4475	V4533	L4603
K3902	S4019	S4019	A4083	R4158	D4216	G4278	G4338	D4398	R4476	Y4534	R4604
I3903	M4020	M4020	R4084	A4159	F4217	P4279	I4339	Q4401	P4477	V4535	T4605
D3904	Q3961	Q3961	K4085	G4160	T4220	D4280	Q4340	L4404	H4478	Y4536	A4606
I3905	I3962	E4022	L4086	L4161	W4221	F4281	K4342	S4405	C4479	G4537	Q4607
K3906	S3963	K4023	L4087	K4162	Y4284	S4282	D4343	L4406	F4480	L4539	T4608
R3907	R3964	Y4024	Q4088	R4163	H4227	Y4284	F4283	W4407	W4481	M4540	P4609
K3908	A4025	A4025	Q4089	T4164	L4228	G4286	S4345	S4409	M4482	E4541	E4610
R3909	E3966	E4026	T4090	Y4165	L4228	G4286	G4346	R4408	T4483	G4542	H4611
M3968	K3967	G4027	M4091	S4166	D4229	Y4287	G4347	S4409	G4484	A4543	W4612
W3969	M3968	W4028	A4092	G4167	M4288	I4289	G4348	T4410	F4485	W4544	V4613
K3911	M3969	V4028	M4093	V4168	D4230	M4288	D4349	L4411	F4486	W4545	L4614
H3912	K3970	L4030	G4094	S4169	M4231	I4289	E4350	T4412	M4487	D4546	R4615
E3913	I3971	D4031	G4095	Q4170	D4232	P4290	K4291	E4413	P4488	K4547	G4616
E3914	W3972	L4032	W4096	D4171	W4233	K4291	R4351	L4414	Q4489	L4548	V4617
F3915	F3973	E4033	A4097	L4172	K4234	S4292	E4353	K4415	G4490	M4549	A4618
	D3974	K4034	L4098	L4173	K4235	T4294	A4354	L4416	F4491	W4550	L4619
		T4035				V4295	V4355	A4417		K4551	

D4622
V4623
LYS

F1822	K1079	L1222	F1282	H1342	D1402	L1462	L1522	R1582	Q1642	Y1702	T1762	F1822
A1823	K1080	L1223	E1283	I1343	T1403	C1463	E1523	L1583	L1643	E1703	M1763	A1823
M1824	V1080	L1224	E1284	R1344	T1404	S1464	S1524	C1584	D1644	E1704	L1764	M1824
I1825	F1081	R1224	V1284	R1345	L1405	D1465	I1525	L1585	A1645	K1705	I1765	I1825
C1826	D1082	Q1225	M1285	M1345	L1406	E1466	F1526	C1586	S1646	P1706	G1766	C1826
D1827	G1083	Q1226	N1286	L1346	A1406	D1467	F1527	C1587	G1647	R1707	Q1767	D1827
Q1829	W1084	Cl227	P1287	D1347	H1407	E1468	G1528	K1588	P1649	E1708	L1768	L1828
F1830	M1085	Cl228	D1288	K1348	L1408	L1469	S1529	A1589	P1650	Q1709	S1769	Q1829
L1831	K1086	A1229	Y1289	E1349	L1409	I1469	E1530	L1590	L1650	M1710	K1770	F1830
Y1832	R1090	F1230	K1290	R1351	Q1410	V1471	D1531	L1591	K1651	L1711	G1771	L1831
S1833	F1091	A1232	Q1291	A1352	Q1412	L1472	I1532	E1592	T1652	F1712	D1772	Y1832
E1835	F1092	EL233	R1293	W1353	L1413	E1473	R1533	Y1593	S1653	D1713	R1773	S1833
Y1836	K1093	Q1234	Q1294	D1354	H1414	D1474	A1534	L1594	L1654	H1714	Q1774	Y1834
L1837	H1114	Q1235	Q1295	A1355	H1415	M1475	Q1535	D1595	G1655	P1715	K1775	E1835
G1838	V1115	Q1236	R1296	F1356	Y1416	Q1476	L1536	T1596	M1656	A1716	I1776	Y1836
N1839	T1116	F1237	E1298	T1357	Q1417	V1477	P1537	K1597	Y1657	Q1717	M1777	L1837
P1841	W1117	F1237	EL298	G1358	D1418	Q1478	Q1538	R1598	S1658	V1718	L1778	G1838
L1842	H1118	EL239	V1299	L1359	E1419	L1479	D1539	L1599	K1659	A1719	I1779	N1839
L1843	L1119	Q1240	C1300	E1360	Y1420	Q1480	S1540	A1600	E1660	L1720	C1780	T1840
V1844	A1120	F1241	Q1301	S1361	M1481	M1480	K1541	F1601	E1661	T1721	T1781	P1841
I1845	M1121	H1242	Q1302	T1362	L1482	V1483	R1542	P1602	E1662	C1722	I1782	R1842
T1846	M1122	K1243	L1303	T1363	V1483	M1484	F1543	R1603	Y1663	T1723	D1783	L1843
P1847	L1123	EL244	E1304	W1364	V1424	M1484	E1544	F1604	V1664	Q1724	V1784	V1844
L1848	D1124	EL245	L1305	M1365	D1425	S1485	G1545	Y1605	A1665	I1725	H1785	H1845
T1849	D1125	P1246	W1306	T1366	K1426	K1486	I1546	F1606	F1666	V1726	A1786	T1846
L1850	A1126	F1247	D1307	L1367	A1427	Y1487	D1547	L1607	S1667	W1727	R1787	P1847
L1851	I1126	R1248	T1308	S1368	A1428	V1488	I1548	S1608	E1668	T1728	D1788	L1848
R1851	K1127	F1249	I1309	S1369	K1429	A1489	D1549	S1609	P1669	T1729	V1789	T1849
C1852	K1128	F1250	G1310	L1370	E1430	F1490	F1550	D1610	C1670	E1730	V1790	L1850
Y1853	S1129	S1251	G1311	L1371	M1431	F1491	K1551	S1611	D1671	Y1731	A1791	R1851
L1854	E1130	EL252	V1312	A1372	G1432	L1492	E1552	L1612	C1672	G1732	K1792	C1852
T1855	G1132	H253	T1313	V1373	M1433	E1493	L1553	L1613	S1673	M1733	M1793	Y1853
L1856	L1133	P1254	S1314	A1374	E1434	E1494	A1554	D1614	G1674	A1734	I1794	L1854
L1857	L1134	H255	S1315	E1375	E1435	V1495	Y1555	L1615	Q1675	F1735	A1795	I1855
Q1858	G1135	Q1256	I1316	E1376	T1436	S1496	D1556	L1616	V1676	A1736	Q1796	L1856
V1859	L1136	M257	H1317	L1376	L1437	G1497	D1557	L1617	E1677	R1737	K1797	T1857
S1859	K1136	M257	A1318	M1378	K1438	W1498	Q1558	M1618	L1678	L1738	V1798	Q1858
L1860	W1137	M257	W1319	P1379	E1439	Q1499	K1559	G1619	W1679	E1739	D1799	S1859
H1861	M1200	D1259	W1319	P1379	E1439	Q1499	K1559	G1619	W1679	E1739	D1799	S1859
L1862	L1201	A1260	E1320	A1380	L1440	K1500	I1560	T1620	L1680	E1740	M1800	L1860
L1863	K1202	R1261	T1322	I1381	Q1441	K1501	P1561	A1621	M1681	G1741	A1801	H1861
M1864	G1140	H1262	T1322	R1382	T1442	L1502	M1562	P1622	H1682	Y1742	Q1802	L1862
S1865	V1204	K1263	P1323	E1383	T1443	L1503	V1563	Q1623	H1683	E1743	A1803	T1863
W1866	A1205	EL264	W1324	R1384	W1444	T1504	V1564	Q1624	L1684	S1744	F1804	M1864
Q1866	Q1143	I1265	R1325	H1385	M1445	V1505	Q1565	V1625	G1685	A1745	L1805	S1865
G1867	G1144	Q1266	M1326	W1386	G1446	D1506	T1566	Q1626	H1686	M1746	W1806	G1866
L1868	G1145	Q1267	M1327	W1387	M1447	E1507	T1567	Q1627	H1687	K1747	L1807	A1867
A1869	L1146	Q1267	M1328	Q1388	E1448	V1508	M1568	H1628	K1688	D1748	S1808	P1868
G1870	V1147	EL269	V1329	L1389	F1449	I1509	K1569	L1629	A1689	Y1749	Q1809	A1869
A1872	Q1210	S1270	E1330	M1390	Q1450	S1510	P1570	S1630	L1690	Y1750	L1810	G1870
G1873	Q1211	EL271	A1331	Q1391	Y1451	I1511	K1571	K1631	V1691	K1751	R1811	L1871
L1874	V1212	M1272	M1332	A1392	E1452	W1512	L1572	L1632	A1692	K1752	H1812	A1872
L1875	A1213	A1273	E1333	G1393	H1454	E1514	Y1574	F1633	H1693	Q1753	R1813	G1873
K1876	L1215	S1274	L1334	G1394	H1455	E1515	E1575	D1634	E1694	V1754	W1814	L1874
T1877	Q1216	EL276	E1335	V1395	P1455	V1515	K1575	M1635	M1695	A1755	D1816	G1875
E1878	A1217	EL277	C1336	S1396	R1456	Q1516	L1576	M1636	T1696	Q1756	D1817	K1876
L1880	S1278	EL277	Q1337	F1397	M1457	R1517	E1577	D1637	E1697	L1757	E1817	T1877
L1881	EL219	S1278	K1338	T1398	M1458	V1518	D1578	K1638	G1698	L1758	L1818	E1878
L1881	E1219	A1279	F1339	T1399	V1459	V1519	D1579	M1639	V1699	T1759	K1819	L1879
L1881	V1220	A1340	A1340	D1400	P1460	T1520	Q1580	R1640	T1700	L1760	H1820	T1880
L1881	L1281	R1341	R1341	Q1401	L1461	H1521	G1581	F1641	A1701	I1761	K1821	K1881

A2622	T2562	V2502	D2442	E2368	I2302	M2242	F2182	L2122	P2062	L2002	I1942	D1882
L2623	I2563	K2503	P2443	I2369	E2303	D2243	K2183	K2123	D2063	I2003	Q1943	L1883
S2624	I2564	M2504	E2444	Y2370	K2304	D2244	A2184	L2124	R2064	C2004	Q1943	G1884
S2625	R2565	V2505	M2445	E2371	R2305	N2245	V2185	Q2125	P2065	E2005	A1945	R1885
V2626	Q2566	F2506	P2446	H2372	E2306	K2246	W2186	A2126	E2066	I2006	I1946	A1886
V2627	Q2567	M2507	L2447	Y2373	I2307	V2247	W2187	E2127	D2067	M2007	R1947	L1887
S2628	L2568	M2508	Q2448	F2374	Q2308	L2248	D2188	D2128	Q2068	L2008	D1948	G1888
I2629	D2569	Y2509	A2449	V2375	T2309	T2249	E2189	N2129	V2069	V2009	K1949	I1889
I2630	L2630	Y2510	C2450	F2376	E2310	L2250	L2190	L2130	L2070	A2010	K1950	L1890
L2631	Q2571	T2511	L2451	A2377	R2311	A2251	F2191	V2131	M2071	E2011	Q1951	V1891
L2632	H2572	T2512	V2452	A2378	A2312	S2252	G2192	L2132	R2072	G2012	W1952	Y1892
Q2633	V2573	S2513	H2453	L2379	M2313	N2253	I2193	K2133	S2073	F2013	F1953	V1893
H2634	D2574	A2514	L2454	K2380	L2314	E2254	L2194	W2134	L2074	I2014	F1954	F1894
V2639	D2575	M2515	S2455	A2381	T2315	R2255	N2195	V2135	R2075	E2015	F1955	N1895
F2640	R2576	L2516	E2456	F2382	I2316	I2256	F2196	Q2136	D2076	A2016	L1956	C1896
P2641	S2577	Q2517	T2457	G2383	L2317	P2257	A2197	L2137	F2077	Q2017	G1957	S1897
A2642	K2578	A2518	I2458	G2384	F2318	L2258	E2198	E2138	M2078	S2018	E1958	E1898
S2643	L2579	V2519	R2459	A2385	D2319	N2259	G2199	E2139	I2079	L2019	E1959	Q1899
P2644	S2680	L2520	V2460	M2386	K2320	P2260	E2200	L2140	P2080	A2020	I1960	M1900
P2650	L2581	E2521	C2461	V2387	Y2321	T2261	K2201	L2141	K2081	R2021	S1961	D1901
L2651	K2582	L2522	Y2462	Q2388	L2322	M2262	K2202	A2142	L2082	K2022	I1962	Y1902
L2652	E2583	P2523	F2463	D2389	P2323	K2263	D2203	V2143	V2083	F2023	N1963	K1903
L2653	L2584	L2524	M2464	Q2390	T2324	L2264	G2204	R2144	T2084	I2024	P1964	S1904
L2654	T2585	E2525	E2465	L2391	C2325	L2265	L2205	H2145	D2085	T2025	S1965	C1905
P2649	V2586	K2526	R2466	D2393	L2326	F2266	F2206	S2146	D2086	L2026	V1966	G1906
L2655	V2587	Q2527	L2467	Y2394	E2267	S2267	S2207	V2147	M2087	Y2027	G1967	N1907
L2656	Q2588	A2528	M2468	Y2395	I2268	S2268	S2208	F2148	P2088	Q2028	I1968	I1908
A2655	Y2589	G2529	A2469	R2395	S2269	I2269	I2209	V2149	I2089	L2029	F1969	Y1909
L2656	V2590	R2530	K2470	K2407	H2270	M2210	M2210	V2150	F2090	C2030	I1970	K1910
L2657	S2591	M2531	Q2471	T2408	L2271	R2211	R2211	G2151	M2091	K2031	T1971	G1911
A2657	C2592	Y2532	R2472	Q2414	R2272	E2212	E2212	G2152	G2092	E2032	M1972	L1912
F2658	M2593	G2533	P2473	Q2415	T2273	L2213	L2213	A2153	L2093	L2033	N1973	A1913
H2659	L2594	P2534	V2474	T2416	A2274	A2214	A2214	G2154	I2094	L2034	P1974	Q1914
Q2660	T2595	P2535	M2475	T2417	Q2342	N2215	N2215	T2155	G2095	S2035	G1975	T1915
L2661	T2596	G2536	L2476	T2418	S2343	I2216	I2216	G2156	D2096	K2036	Y1976	G1916
L2662	A2597	M2537	V2477	F2418	M2344	A2277	T2217	K2157	L2097	Q2037	A1977	A1917
L2663	K2598	K2538	T2478	V2419	V2345	V2278	H2218	S2158	F2098	D2038	G1978	M1918
L2664	S2599	L2540	T2479	Y2420	V2346	T2279	D2219	Q2159	H2039	L2039	R1979	G1919
L2665	T2600	L2541	G2480	Y2421	S2280	G2220	G2220	V2160	A2100	Y2040	T1980	C1920
F2666	I2602	Y2542	T2482	I2422	R2281	K2221	K2221	L2101	L2101	D2041	E1981	F1921
L2667	N2603	F2543	D2423	D2423	A2282	K2222	K2222	D2102	D2102	W2042	L1982	D1922
L2668	P2604	L2544	K2484	P2424	G2349	Q2223	Q2223	V2103	V2103	G2043	P1983	E1923
L2669	R2605	D2545	S2485	E2425	L2284	I2224	I2224	L2164	F2104	L2044	E1984	F1924
G2670	L2606	D2546	S2486	T2426	L2285	L2225	L2225	H2165	R2105	R2045	N1985	N1925
L2671	Q2607	Q2547	V2486	K2428	E2353	L2226	L2226	K2166	D2096	A2046	L1986	R1926
L2672	R2608	M2548	V2488	F2429	I2287	D2227	D2227	T2167	R2107	I2047	K1987	I1927
F2673	H2609	M2549	Q2489	E2430	N2288	G2228	G2228	Y2168	D2108	K2048	S1988	S1928
H2674	F2610	P2550	K2490	E2431	P2289	D2229	D2229	Q2169	P2109	S2049	L1989	V1929
Y2675	V2612	E2551	K2491	W2432	A2290	T2230	T2230	L2170	M2110	V2050	F1990	E1930
F2676	F2613	V2552	L2492	S2433	L2292	K2172	K2172	E2112	P1992	W2052	P1992	L1932
L2677	L2614	A2554	A2493	K2434	G2293	M2234	M2234	R2173	C1993	V2053	C1993	S1933
L2678	L2615	S2494	S2494	V2436	W2294	W2234	W2234	L2174	A1994	A2054	A1994	V1934
L2679	S2616	L2495	L2495	V2437	N2295	L2235	L2235	P2175	M1995	G2055	A1995	V1935
R2680	F2617	G2556	D2496	P2437	P2296	E2236	E2236	V2176	V1996	S2056	V1996	A1936
L2681	Q2618	T2557	P2497	Q2438	P2297	S2237	S2237	W2177	L2057	L2057	V1997	V1937
L2682	P2619	V2558	E2498	F2439	P2298	V2238	V2238	T2178	P1998	K2058	P1998	Q1938
A2683	A2620	P2560	Y2500	E2440	S2299	N2239	N2239	D2179	R2059	R2059	L1999	V1939
N2684	D2621	H2561	L2501	F2441	K2367	S2300	W2301	L2180	V2120	G2060	F2000	K1940
								N2181	D2121	D2061	E2001	S1941

D3431	D3432	D3433	D3434	D3435	D3436	D3437	D3438	D3439	D3440	E3441	G3442	L3443	F3444	A3445	D3446	F3387	S3388	Y3389	L3390	E3391	F3392	F3393	T3394	L3455	L3456	L3457	C3458	E3460	R3461	F3462	L3464	H3465	D3466	R3467	F3468	Q3469	L3470	Q3471	G3472	L3473	K3474	H3475	L3476	K3477	R3478	K3479	L3480	G3481	E3482	D3483	L3484	R3485	L3486	L3487	Q3488	L3489	G3490																							
M3251	P3252	E3253	F3254	V3255	A3256	L3257	K3258	S3259	V3260	A3261	A3262	G3263	E3264	L3265	C3266	S3267	W3268	V3269	I3270	K3331	N3371	I3372	V3373	R3374	F3375	V3376	Y3377	V3378	F3379	S3380	D3381	V3382	S3383	L3384	T3385	S3386	Q3387	E3388	A3389	D3390	K3391	L3392	K3393	C3394	Q3395	V3396	E3397	A3398	E3399	V3400	L3401	L3402	D3403	R3404	T3405	V3406	R3407	F3408	Y3409	L3410	S3411	Q3412	L3413	K3414	L3415	P3416	I3417	R3418	K3419	T3420	P3421	A3422	L3423	D3424	P3425	L3426	K3427	M3428	L3429	M3430
A3191	V3192	M3193	V3194	L3195	M3196	A3197	P3198	S3199	G3200	R3201	V3202	F3203	K3204	D3205	R3206	S3207	W3208	K3209	A3210	A3211	K3212	V3213	T3214	M3215	A3216	K3217	V3218	D3219	G3220	F3221	V3222	D3223	S3224	L3225	I3226	N3227	F3228	K3229	E3230	S3231	N3232	I3233	S3234	H3235	E3236	N3237	C3238	K3239	A3240	I3241	F3242	R3243	Y3244	L3245	Q3246	D3247	S3248	E3249	F3250																					
K3131	V3132	A3133	V3134	L3135	M3136	L3137	E3138	V3139	K3140	Q3141	K3142	Q3143	K3144	D3145	C3146	E3147	E3148	D3149	L3150	A3151	K3152	A3153	E3154	P3155	A3156	L3157	T3158	A3159	A3160	Q3161	A3162	A3163	L3164	M3165	K3166	L3167	I3168	K3169	T3170	N3171	G3172	T3173	E3174	L3175	K3176	S3177	F3178	G3179	S3180	P3181	P3182	L3183	M3184	V3185	D3186	E3187	V3188	S3189	A3190																					
N3071	G3072	L3073	L3074	K3075	M3076	H3077	S3078	T3079	S3080	A3081	Q3082	V3083	D3084	L3085	L3086	K3087	A3088	K3089	L3090	A3091	A3092	Q3093	E3094	V3095	A3096	L3097	K3098	Q3099	K3100	N3101	A3102	E3103	A3104	D3105	K3106	L3107	I3108	Q3109	V3110	N3111	G3112	V3113	E3114	T3115	D3116	K3117	V3118	S3119	R3120	E3121	K3122	L3123	M3124	A3125	D3126	E3127	V3128	S3129	Q3130																					
V2951	T2952	L2953	C2954	F2955	S2956	P2957	V2958	G2959	N2960	K2961	L2962	R2963	V2964	R2965	S2966	K2967	K2968	F2969	P2970	A2971	D2972	V2973	N2974	C2975	T2976	A2977	L2978	H2979	W2980	F2981	H2982	E2983	W2984	P2985	Q2986	Q2987	A2988	L2989	E2990	S2991	V2992	D2993	L2994	R2995	F2996	L2997	Q2998	N2999	T3000	E3001	G3002	I3003	E3004	P3005	T3006	V3007	K3008	Q3009	S3010																					
I3011	S3012	K3013	F3014	M3015	A3016	F3017	V3018	H3019	T3020	S3021	V3022	N3023	Q3024	T3025	S3026	Q3027	S3028	Y3029	L3030	S3031	D3032	E3033	Q3034	R3035	V3036	N3037	V3038	T3039	T3040	P3041	K3042	S3043	F3044	L3045	E3046	F3047	L3048	R3049	K3050	V3051	Q3052	S3053	L3054	L3055	H3056	R3057	H3058	R3059	K3060	E3061	L3062	K3063	C3064	K3065	A3066	D3067	E3068	L3069	E3070																					
R2891	F2892	L2893	V2894	F2895	G2896	M2897	D2898	L2899	L2900	A2901	S2902	G2903	E2904	L2905	P2906	D2907	L2908	Y2909	S2910	D2911	D2912	E2913	V2914	E2915	N2916	L2917	L2918	S2919	N2920	V2921	R2922	M2923	E2924	V2925	K2926	S2927	Q2928	G2929	L2930	V2931	D2932	M2933	R2934	E2935	N2936	C2937	W2938	K2939	F2940	F2941	L2942	D2943	D2944	L2945	Q2946	R2947	Q2948	L2949	K2950																					
M2820	A2821	L2822	L2823	V2824	G2825	L2826	G2827	G2828	S2829	S2830	S2831	R2832	M2833	D2834	V2835	F2836	L2837	L2838	T2839	L2840	L2841	L2842	G2843	D2844	V2845	F2846	T2847	L2848	E2849	F2850	L2851	R2852	K2853	G2854	V2855	Q2856	L2857	Q2858	D2859	F2860	K2861	M2862	L2863	L2864	A2865	S2866	L2867	C2868	L2869	K2870	A2871	G2872	V2873	K2874	M2875	E2801	D2802	A2803	M2804	R2805	H2806	L2813	L2814	E2815	L2816	P2817	R2818	D2819	E2890											
T2750	Q2751	S2752	P2753	N2754	L2755	Y2756	A2760	N2761	G2762	G2763	G2764	E2765	P2770	V2771	Q2772	S2773	W2774	E2775	L2776	L2777	T2778	Q2779	T2780	L2781	V2782	E2783	A2784	L2785	L2786	E2787	N2788	H2789	L2790	E2791	N2792	T2793	V2794	M2795	D2796	L2797	V2798	L2799	F2800	E2801	D2802	A2803	M2804	R2805	H2806	L2813	L2814	E2815	L2816	P2817	R2818	D2819	E2890																							
I2685	F2686	Q2687	S2689	V2694	E2695	C2696	V2697	K2698	S2699	T2700	W2701	D2702	L2703	L2704	R2705	L2706	Y2707	L2708	S2711	N2712	R2713	W2714	V2715	V2716	D2717	K2718	W2719	W2720	E2721	E2722	K2723	D2724	F2725	D2726	L2727	F2728	D2729	K2730	L2731	G2732	T2733	E2734	V2735	L2736	K2737	K2738	T2739	F2740	D2741	D2742	L2743	E2744	D2745	F2746	V2747	E2748	D2749																							

Q3491	K3492	G3493	Y3494	L3495	Q3496	L3497	L3498	E3499	Q3500	L3502	E3503	A3504	A3505	G3506	V3507	V3508	L3509	I3510	E3511	R3512	L3513	E3514	S3516	L3517	D3518	P3519	V3520	L3521	G3522	P3523	L3524	L3525	G3526	R3527	E3528	V3529	I3530	K3531	F3535	I3536	K3537	I3538	G3539	D3540	K3541	E3542	C3543	R3550	L3551	I3552	L3553	H3554	T3555	K3556	L3557																																																						
A3568	N3569	P3560	H3561	Q3562	Q3563	P3564	E3565	Q3566	Q3567	Q3569	T3571	L3572	I3573	N3574	F3575	T3576	V3577	T3578	R3579	D3580	G3581	L3582	E3583	D3584	Q3585	L3586	L3587	A3588	A3589	V3590	L3591	S3592	M3593	E3594	R3595	P3596	L3597	L3598	E3599	Q3600	L3601	K3602	S3603	D3604	L3605	T3606	K3607	Q3608	Q3609	N3610	G3611	F3612	K3613	I3614	L3615	L3616	K3617																																																				
T3618	L3619	E3620	D3621	S3622	L3623	L3624	S3625	L3626	S3627	S3628	S3629	A3630	S3631	G3632	N3633	P3634	L3635	G3636	E3637	V3638	L3640	V3641	E3642	N3643	L3644	E3645	T3646	K3648	Q3649	T3650	A3651	A3652	E3653	V3654	E3655	K3656	K3657	V3658	Q3659	E3660	A3661	K3662	V3663	T3664	E3665	V3666	K3667	I3668	N3669	E3670	I3671	D3672	E3673	H3674	R3675	L3676	P3677																																																				
A3678	A3679	A3680	R3681	A3682	S3683	L3684	L3685	Y3686	F3687	I3688	M3689	A3690	D3691	L3692	S3693	K3694	I3695	H3696	P3697	M3698	Q3700	F3701	S3702	E3703	L3704	A3705	F3706	S3707	L3708	V3709	F3710	Q3711	K3712	A3713	V3714	E3715	R3716	A3717	A3718	P3719	D3720	E3721	S3722	L3723	R3724	E3725	R3726	V3727	A3728	N3729	E3730	I3731	D3732	E3733	H3734	I3735	F3736	S3737																																																			
V3738	Y3739	Q3740	Y3741	T3742	I3743	R3744	G3745	L3746	Y3754	Q3757	L3758	T3759	F3760	Q3761	I3762	L3763	L3764	M3765	R3766	N3767	Q3768	F3769	N3770	A3771	V3772	E3773	L3774	D3775	E3808	G3819	S3820	A3821	K3822	S3823	W3824	K3825	K3826	E3829	S3830	N3844	K3845	T3846	A3847	L3848	F3869	K3873	L3874	G3875	S3876	K3877	Y3878	R3882	A3883	L3884	D3885	L3886	F3887	A3888	A3889	K3890	E3891	S3892	G3893	C3894	P3895	A3896	T3897	P3898	K3899	F3900	L3901	L3902	L3903	D3908	P3909	L3910	K3911	D3912	V3913	E3914	S3915	G3916	R3917	L3918	K3919	L3920	G3921	Y3922	F3923	L3924	N3925	N3926	Q3927	N3928	F3929	H3930	N3931	V3932	S3933	G3934	L3935	Q3936	G3937	Q3938	E3939	V3940	V3941	A3942	E3943
A3944	A3945	L3946	D3947	L3948	A3949	A3950	K3951	K3952	G3953	H3954	V3955	V3956	I3957	L3958	Q3959	N3960	H3961	H3962	L3963	A3964	S3965	K3966	V3967	L3968	S3969	T3970	L3971	E3972	K3973	K3974	L3975	E3976	E3977	H3978	S3979	E3980	N3981	S3982	H3983	P3984	E3985	F3986	R3987	V3988	F3989	M3990	S3991	A3992	S3993	G3994	A3995	P3996	V4001	A4002	E4003	P3998	E3999	G4000	H4001	I4002	I4003																																																
P4004	Q4005	G4006	I4007	L4008	E4009	M4010	S4011	L4012	K4013	L4014	T4015	M4016	H4022	H4023	A4024	M4025	L4026	H4027	K4028	A4029	L4030	D4031	M4032	F4033	T4034	Q4035	D4036	L4037	L4038	E4039	M4040	C4041	S4042	R4043	E4044	T4045	E4046	F4047	K4048	S4049	L4050	F4052	A4053	L4054	C4055	Y4056	F4057	H4058	A4059	V4060	V4061	A4062	E4063	R4064	R4065	K4066	F4067																																																				
Q4070	G4071	W4072	W4073	R4074	S4075	Y4076	Y4077	F4078	M4079	T4080	G4081	D4082	L4083	T4084	I4085	S4086	Y4087	M4088	Y4089	L4090	Y4091	M4092	F4093	L4094	E4095	A4096	M4097	A4098	K4099	V4100	P4101	Y4102	D4103	L4104	L4105	R4106	Y4107	L4108	F4109	G4110	E4111	I4112	M4113	Y4114	G4115	H4116	H4117	I4118	T4119	D4120	W4122	D4123	R4124	R4125	L4126	C4127	R4128																																																				
T4129	Y4130	L4131	G4132	E4133	F4134	I4135	R4136	P4137	E4138	M4139	L4140	E4141	E4142	E4143	L4144	S4145	L4146	A4147	P4148	G4149	F4150	P4151	L4152	P4153	M4154	M4155	M4156	D4157	Y4158	M4159	A4160	Y4161	H4162	Q4163	Y4164	I4165	D4166	A4167	E4168	L4169	P4170	P4171	E4172	S4173	P4174	Y4175	L4176	Y4177	G4178	L4179	H4180	P4181	M4182	A4183	E4184	E4201	L4202	Q4203																																																			
P4204	R4205	D4206	S4207	Q4208	A4209	R4210	D4211	G4212	A4213	G4214	A4215	T4216	R4217	E4218	E4219	K4220	K4221	K4222	A4223	L4224	E4227	I4228	F4236	P4239	E4240	L4241	M4242	A4243	K4244	V4245	E4246	E4247	R4248	T4249	P4250	Y4251	I4252	V4253	Y4254	A4255	F4256	Q4257	E4258	C4259	E4275	L4276	E4277	L4278	G4279	L4280	K4281	G4282	E4283	L4284	T4285																																																						
M4286	T4287	S4288	H4289	M4290	E4291	Q4294	M4295	Y4298	I4328	K4329	A4330	L4331	E4332	A4333	M4334	T4335	G4336	D4337	F4338	T4339	M4340	P4341	S4342	K4343	T4344	V4344	W4345	L4346	F4349	F4350	M4351	P4352	Q4353	S4354	F4355	L4356	T4357	I4359	M4360	Q4361	S4362	T4363	A4364	R4365	K4366	M4367	E4368	W4369	P4370	L4371	D4372	Q4373	M4374	A4375	L4376																																																						
Q4377	C4378	D4379	M4380	T4381	K4382	K4383	E4387	F4388	R4389	S4390	P4391	P4392	E4394	G4395	A4396	Y4397	I4398	M4403	E4404	G4405	A4406	C4407	M4408	D4409	A4412	G4413	I4414	T4415	T4416	E4417	A4418	K4419	L4420	R4421	D4422	L4423	T4424	P4425	M4430	F4431	I4432	K4433	A4434	I4435	P4436	A4437	D4438	K4439	Q4440	D4441	C4442	R4443	S4444	Y4445																																																							

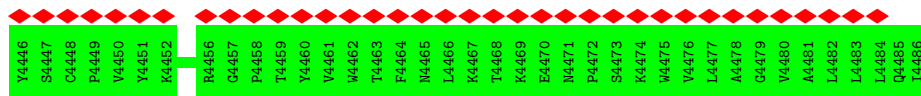

● Molecule 104: Dynein axonemal heavy chain 9

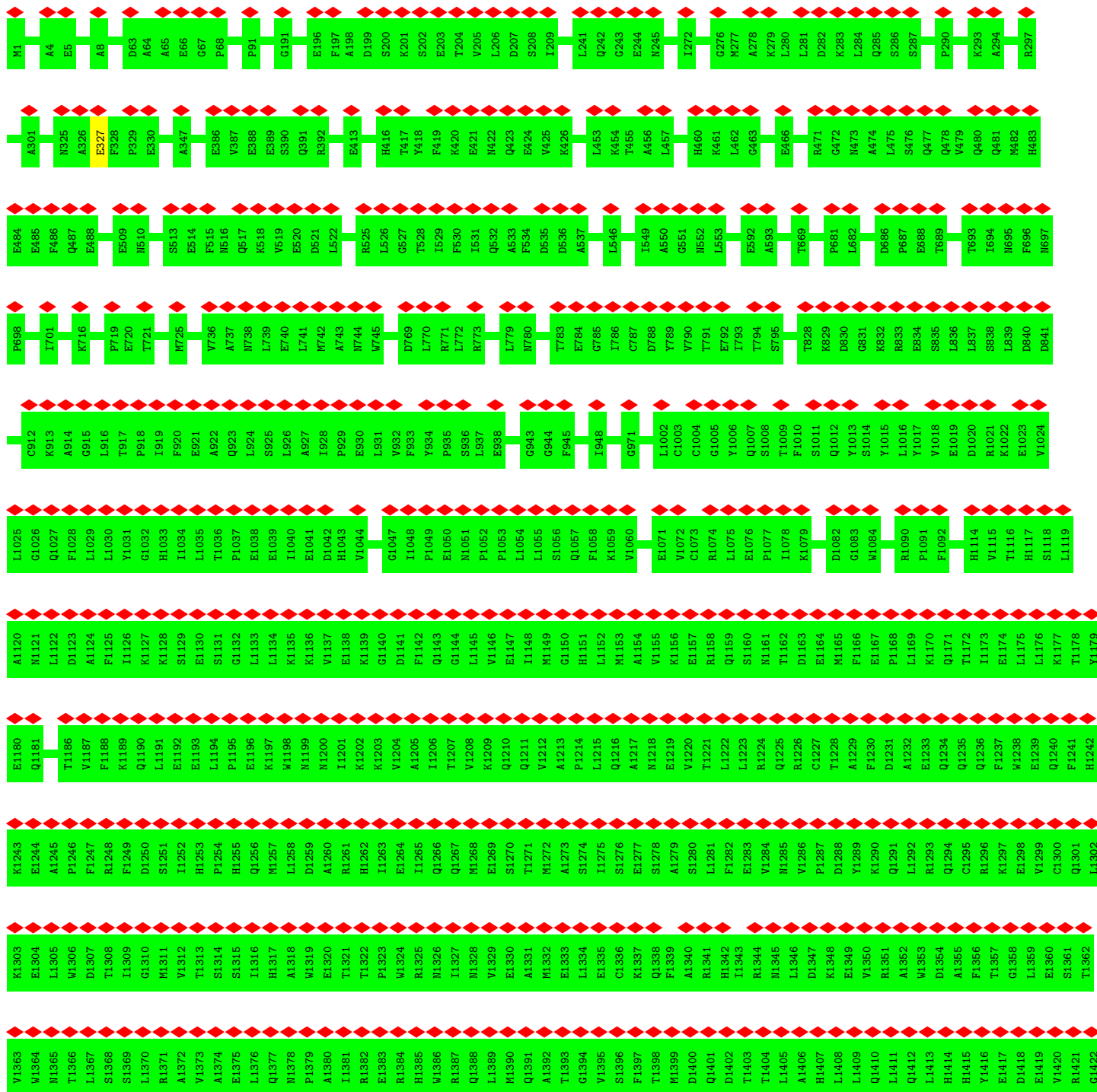
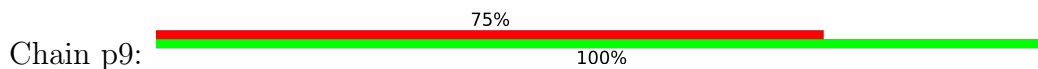

V2143	V2083	F2023	M1963	K1903	L1843	D1783	TL723	Y1663	R1603	F1543	V1483	I1423
R2144	T2084	I2024	P1964	S1904	V1844	V1784	Q1724	V1664	F1604	E1544	M1484	V1424
H2145	D2085	T2025	S1965	C1905	I1845	H1785	IL725	A1665	Y1605	G1545	S1485	D1425
S2146	D2086	L2026	V1966	G1906	T1846	A1786	W1726	F1666	F1606	I1546	K1486	K1426
V2147	M2087	Y2027	I1967	I1907	P1847	R1787	W1727	S1667	L1607	D1547	A1487	A1427
F2148	P2088	Q2028	G1968	I1908	L1848	D1788	TL728	E1668	S1608	I1548	V1488	K1428
V2150	I2089	L2029	F1969	Y1909	T1849	V1789	TL729	P1669	P1609	D1549	A1489	E1430
G2151	M2090	C2030	IL970	K1910	D1850	V1790	E1730	C1670	S1610	F1550	F1490	M1431
G2152	G2092	K2031	IL971	G1911	R1851	A1791	V1731	D1671	L1611	K1551	L1491	G1432
L2153	L2093	E2032	M1972	L1912	C1852	K1792	G1732	C1672	L1612	E1552	L1492	M1433
G2154	I2094	L2034	M1973	A1913	Y1853	M1793	ML733	S1673	L1613	L1553	E1493	E1434
T2155	G2095	S2035	P1974	Q1914	I1854	IL794	A1734	G1674	D1614	A1554	E1494	K1435
G2156	D2096	K2036	V1975	T1945	T1855	Q1795	FL735	V1675	I1615	Y1555	V1495	T1436
L2157	L2097	Q2037	Y1976	G1916	L1856	A1796	A1736	V1676	L1616	D1556	S1496	K1437
S2158	F2098	D2038	G1978	W1918	Q1858	V1798	L1738	I1678	M1618	Q1558	W1498	K1438
Q2159	P2099	H2039	IL979	G1919	S1859	D1799	EL739	W1679	G1619	K1559	Q1499	E1439
Q2160	A2100	Y2040	TL980	C1920	L1860	M1800	EL740	L1680	T1620	I1560	K1500	L1440
L2161	L2101	D2041	E1981	F1921	H1861	A1801	G1741	M1681	A1621	P1561	K1501	Q1441
D2162	D2102	W2042	L1982	E1922	L1862	Q1802	Y1742	H1682	P1622	M1562	L1502	T1442
L2163	G2043	G2043	P1983	E1923	T1863	A1803	EL743	V1683	Q1623	V1563	S1503	TL443
L2164	P2104	L2044	E1984	F1924	M1864	F1804	S1744	L1684	Q1624	W1564	T1504	W1444
H2165	R2105	R2045	M1985	N1925	S1865	L1805	A1745	G1685	V1625	Q1565	V1505	A1445
K2166	R2106	A2046	L1986	R1926	G1866	W1806	M1746	H1686	Q1626	T1566	D1506	G1446
T2167	D2107	I2047	K1987	IL927	A1867	L1807	KL747	M1687	R1627	IL567	A1507	M1447
Q2168	R2108	K2048	S1988	S1928	P1868	S1808	DL748	K1688	H1628	M1568	V1508	E1448
Q2169	P2109	S2049	L1989	V1929	A1869	Q1809	Y1749	A1689	L1629	K1569	I1509	F1449
N2110	N2110	V2050	F1990	E1930	G1870	L1810	Y1750	T1690	S1630	P1570	S1510	Q1450
K2171	L2111	L2051	A1991	V1931	P1871	R1811	K1751	V1691	K1631	G1571	I1511	W1451
E2112	E2112	V2052	P1992	L1932	A1872	H1812	K1752	R1692	L1632	L1572	W1512	E1452
A2113	C1993	V2053	C1993	S1933	G1873	R1813	Q1753	H1693	F1633	Y1573	F1513	P1453
L2114	A1994	A2054	A1994	V1934	T1874	W1814	W1754	E1694	D1634	E1574	E1514	H1454
P2115	M1995	G2055	M1995	V1935	G1875	D1815	A1755	M1695	M1635	K1575	V1515	P1455
R2116	R2116	S2056	L1986	A1936	K1876	D1816	Q1756	T1696	M1636	L1576	Q1516	P1456
W2177	K2117	L2057	V1997	V1937	T1877	E1817	FL757	E1697	A1637	E1577	R1517	TL457
L2178	A2118	K2058	P1998	Q1938	E1878	V1818	K1758	G1698	K1638	D1578	W1518	M1458
D2179	I2119	R2059	D1999	V1939	IL879	K1819	TL759	V1699	M1639	I1579	W1519	P1459
M2181	D2120	G2060	F2000	K1940	T1880	H1820	L1760	T1700	R1640	Q1580	W1520	L1460
K2182	L2122	D2061	E2001	S1941	K1881	C1821	IL761	AI701	F1641	G1581	H1521	L1461
K2183	K2123	D2063	I2003	IL942	D1882	F1822	TL762	Y1702	Q1642	R1582	L1522	L1462
L2184	L2124	R2064	C2004	Q1943	L1883	A1823	M1763	E1703	L1643	L1583	E1523	C1463
Q2185	Q2125	P2065	E2005	A1945	G1884	M1824	L1764	E1704	D1644	C1584	S1524	S1464
A2126	A2126	E2066	E2006	IL946	A1885	I1825	IL765	K1705	A1645	L1585	I1525	D1465
E2127	E2127	M2067	M2007	IL947	A1886	C1826	G1766	P1706	S1646	C1586	F1526	E1466
D2128	Q2128	Q2068	Q2008	R1948	L1887	D1827	Q1767	RI707	G1647	K1587	T1527	D1467
N2129	N2129	V2069	V2009	K1949	G1888	A1828	L1768	E1708	E1648	L1588	G1528	L1468
F2130	F2130	L2070	A2010	K1950	I1889	Q1829	S1769	Q1709	P1649	A1589	S1529	I1469
L2131	L2131	M2071	E2011	Q1951	L1890	F1830	K1770	W1710	T1650	L1590	E1530	E1470
K2133	K2133	S2073	F2013	V1952	V1891	L1831	G1771	LI711	K1651	E1591	D1531	W1471
V2134	V2134	L2074	I2014	F1953	V1893	S1833	RI773	F1712	S1652	A1592	I1532	E1473
N2135	N2135	E2015	E2015	S1954	F1894	Y1834	Q1774	H1714	L1654	L1594	A1534	D1474
Q2136	Q2136	D2076	A2016	M1955	M1895	E1835	IL775	P1715	G1655	D1595	Q1535	M1475
L2137	L2137	F2077	Q2017	L1956	C1896	W1836	TL776	A1716	M1656	L1596	Q1536	O1476
E2138	E2138	N2078	G1957	G1957	S1897	L1837	M1777	Q1717	Y1657	K1597	P1537	V1477
E2139	E2139	I2079	E1958	E1958	E1898	G1838	TL778	V1718	S1658	R1598	Q1538	O1478
E2140	E2140	P2080	Q1999	Q1999	Q1899	M1839	IL779	AI719	K1659	L1599	D1539	L1479
L2141	L2141	K2081	M1901	M1901	M1801	L1840	C1780	L1720	E1660	A1600	S1540	Q1480
A2142	A2142	I2082	D1962	V1902	Y1902	R1842	TL782	TI721	E1662	F1602	K1541	M1481

F2969	Y2909	I2849	W2774	Y2707	S2643	S2580	L2520	V2461	Q2390	P2323	K2263	D2203
P2970	S2910	T2850	E2775	L2708	L2644	L2581	E2521	C2461	L2391	T2324	L2264	G2204
A2971	D2911	L2851	L2776		Q2645	K2582	K2522	Y2462	V2392	Y2462	L2265	G2205
I2972	D2912	R2852	L2777	S2711	K2646	E2583	P2523	F2463	D2393	F2463	F2266	F2206
V2973	E2913	K2853	T2778	N2712	S2647	I2584	P2524	M2464	Y2394	M2464	E2267	S2207
C2975	N2914	Q2854	Q2779	Y2715	I2648	T2585	E2525	E2465	R2395	E2465	I2268	S2208
M2976	N2915	Q2856	P2649	R2716	P2649	N2586	K2526	R2466	A2396	R2466	S2269	I2209
T2977	N2916	I2857	P2650	D2717	P2650	V2587	K2527	L2467	K2407	L2467	H2270	H2210
A2977	N2917	I2858	P2651	R2718	L2851	Q2588	K2528	M2468	T2408	M2468	R2271	R2211
H2979	I2918	Q2858	L2852	K2718	I2852	Q2588	G2529	A2469	F2411	A2469	R2272	E2212
W2980	N2920	D2859	D2853	M2719	D2853	Y2589	G2529	R2470	P2412	R2470	T2273	L2213
	Y2921	F2860	L2854	N2720	L2854	S2591	N2531	Q2471	P2412	E2341	A2274	A2214
	R2922	K2861	A2855	E2721	A2855	C2592	G2532	Q2472	P2413	Q2342	T2275	H2215
	N2923	D2862	L2856	E2722	L2856	M2593	G2533	R2472	S2413	S2343	P2276	I2216
	E2924	L2864	A2857	K2723	A2857	N2594	P2534	P2473	Q2414	M2344	A2277	T2217
	K2925	L2864	F2858	D2724	F2858	P2595	P2535	V2474	G2415	W2345	T2278	H2218
	V2926	A2866	H2859	F2725	H2859	T2596	G2536	L2476	T2416	Q2346	T2279	G2220
	S2927	S2866	Q2660	D2726	Q2660	A2597	N2537	V2477	I2417	M2347	S2280	D2221
	Q2928	L2867	K2861	L2727	K2861	G2598	K2538	G2478	F2418	V2348	R2281	K2222
	R2929	C2868	I2862	F2728	I2862	S2599	K2539	T2479	D2419	C2349	A2282	W2223
	G2930	L2869	A2863	D2729	A2863	F2600	L2540	A2480	Y2420	H2350	G2283	I2224
	L2931	K2870	L2864	K2730	L2864	T2601	I2541	G2481	Y2421	L2351	I2284	L2225
	V2931	A2871	T2865	I2731	T2865	I2602	Y2542	T2482	D2422	E2352	L2285	L2226
	D2932	G2872	F2666	Q2732	F2666	N2603	F2543	Q2483	D2423	E2353	Y2286	L2227
	N2933	V2873	L2867	T2733	L2867	P2604	I2544	P2424	P2424	C2354	I2287	G2228
	R2934	K2874	P2668	E2734	P2668	R2605	D2545	K2428	K2428	L2355	N2288	D2229
	E2935	M2875	T2669	V2735	T2669	L2606	V2546	V2486	T2427	L2356	P2289	I2230
	N2936	L2876	G2670	K2736	G2670	Q2607	M2547	L2487	K2427	T2357	A2290	I2231
	Q2937	E2801	L2671	L2737	L2671	R2608	N2548	V2488	K2428	T2358	D2291	D2232
	W2938	D2802	K2672	K2738	K2672	H2609	M2549	G2489	F2429	E2359	L2292	K2233
	K2939	A2803	F2673	T2739	F2673	F2610	P2550	A2490	E2430	D2360	G2293	H2234
	F2940	R2805	H2674	F2740	H2674	S2611	E2551	K2491	W2432	I2361	N2294	W2234
	F2941	H2806	Y2675	D2741	Y2675	V2612	V2552	L2492	M2432	P2362	P2296	I2235
	I2942	L2813	L2676	D2742	L2676	F2613	D2553	A2493	S2433	A2363	K2296	E2236
	D2943	L2814	F2677	E2743	F2677	V2614	D2554	S2494	K2434	D2364	P2297	S2237
	R2944	L2814	M2678	I2744	M2678	L2615	A2554	L2495	L2435	P2365	V2298	L2238
	I2945	F2817	S2679	D2745	S2679	S2616	G2556	D2496	V2436	P2366	S2299	N2239
	K2946	R2818	R2680	P2746	R2680	F2617	T2557	T2497	Q2437	K2367	S2299	T2240
	Q2947	G2819	D2681	V2747	D2681	P2618	V2558	E2498	F2439	E2368	W2301	W2241
	R2948	N2820	F2682	E2748	F2682	G2619	Q2559	A2499	F2439	I2369	I2302	H2242
	L2949	A2821	A2683	Q2749	A2683	A2620	P2560	L2500	F2441	T2370	E2303	D2243
	K2950	L2822	M2684	T2750	M2684	D2621	H2561	L2501	D2442	E2371	K2304	D2244
	V2951	L2823	L2685	Q2751	L2685	A2622	T2562	V2502	P2443	Y2372	R2305	H2245
	T2952	L2824	F2686	S2752	F2686	L2623	I2563	K2503	P2443	Y2373	E2306	K2246
	L2953	G2825	Q2687	P2753	Q2687	S2624	L2564	M2504	E2444	F2374	I2307	W2247
	C2954	V2826	W2754	N2754	W2754	S2625	R2565	V2505	M2445	V2375	Q2308	L2248
	F2955	G2827	S2693	A2760	S2693	I2626	Q2566	P2506	F2446	F2376	T2309	T2249
	S2956	L2761	V2694	N2761	V2694	Y2627	H2567	F2507	L2447	A2377	E2310	L2250
	V2957	G2762	E2695	G2762	E2695	S2628	L2568	N2508	Q2448	A2378	R2311	A2251
	Q2958	I2763	C2696	I2763	C2696	I2629	D2569	Y2509	A2449	I2379	A2312	S2252
	G2959	G2764	V2697	G2764	V2697	L2630	Y2570	C2450	C2450	W2380	N2313	H2253
	N2960	E2765	K2698	E2765	K2698	L2631	G2571	L2451	L2451	A2381	I2314	E2254
	K2961	S2842	S2699	T2766	S2699	T2632	G2572	V2452	V2452	F2382	G2383	R2255
	L2962	S2843	T2700	K2767	T2700	Q2633	H2573	H2453	H2453	G2384	I2315	I2256
	R2963	M2845	W2701	D2770	W2701	D2702	Y2574	T2454	T2454	A2385	I2316	F2257
	V2964	D2845	D2702	P2770	D2702	M2514	D2575	A2514	E2456	M2386	F2318	L2258
	S2965	L2946	L2703	Q2771	L2703	M2515	R2576	M2515	E2456	W2387	D2319	H2259
	Q2966	F2847	L2704	Q2772	L2704	Q2517	S2577	Q2517	T2457	Q2388	K2320	T2261
	R2967	Q2948	R2705	S2773	R2705	A2642	K2578	A2518	I2458	D2389	Y2321	W2262
	K2968	L2706	L2706		L2706		L2579					

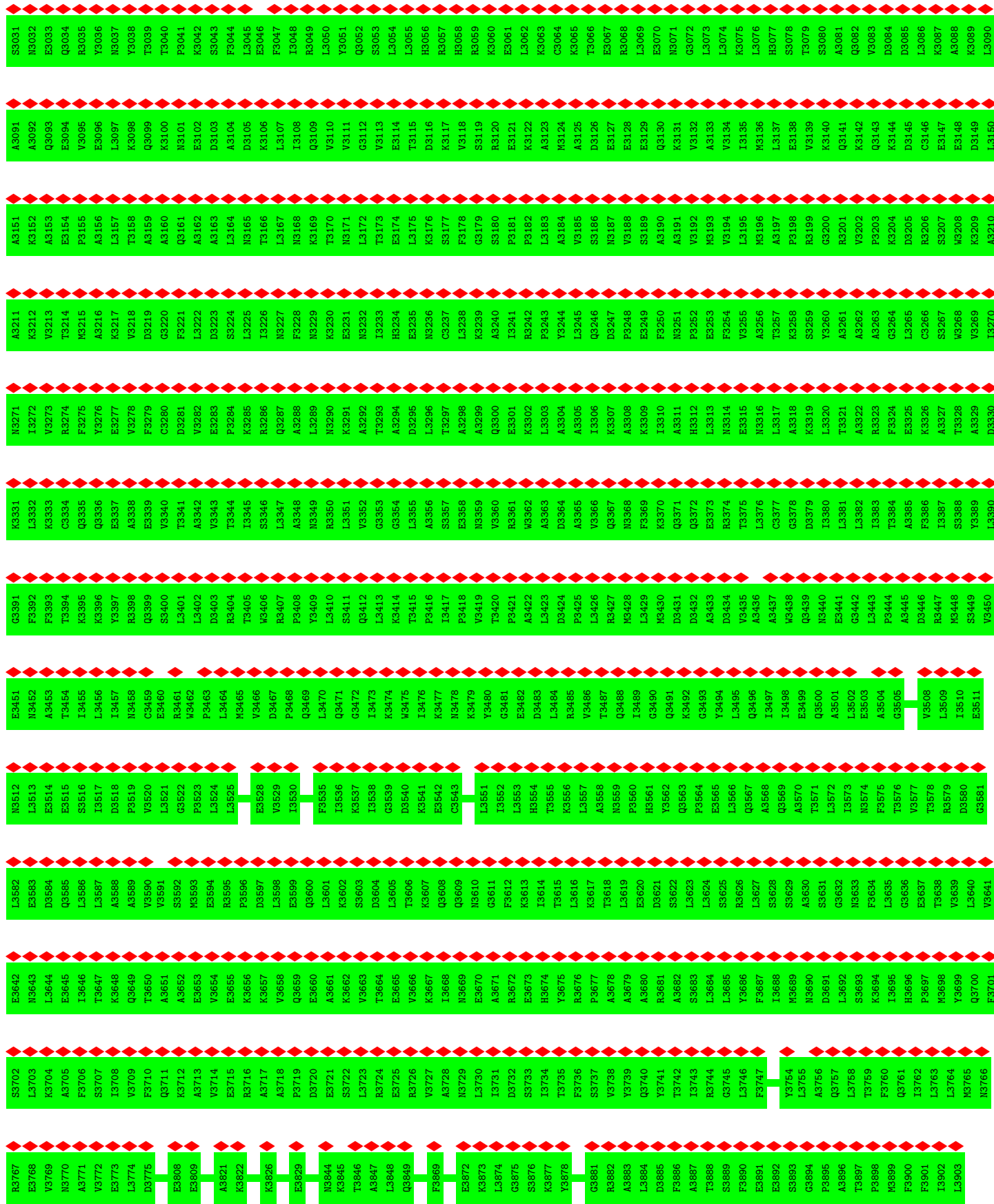

R3767	S3702	E3642	L3582	N3512	E3451	G3391	K3331	A3211	A3151	A3091	SS031
E3768	L3703	N3643	E3583	L3513	N3452	F3392	L3332	K3212	K3152	A3092	R3032
V3769	K3704	L3644	D3584	E3514	A3453	F3393	K3333	V3213	E3093	Q3093	E3033
N3770	A3705	E3645	Q3585	E3515	T3454	T3394	C3334	T3214	E3094	E3094	Q3034
V3771	F3706	L3646	L3586	S3516	K3455	K3395	Q3335	M2115	P3155	V3095	R3035
V3772	S3707	T3647	L3587	I3517	L3456	K3396	Q3336	A3216	A3156	E3096	Y3036
E3773	I3708	K3648	A3588	D3518	L3457	Y3397	E3337	K3217	L3157	L3097	R3037
L3774	F3709	Q3649	A3589	P3519	N3458	R3398	A3338	V3218	T3158	K3098	Y3038
	F3710	T3650	A3590	V3520	C3459	F3399	E3339	F3219	T3159	F3279	T3039
Q3711	V3711	A3651	V3591	L3521	E3460	S3400	V3340	G3220	A3160	Q3100	T3040
A3821	K3712	A3652	G3522	G3522	R3461	L3401	T3341	F3221	Q3161	N3101	F3041
E3809	A3713	E3653	N3593	P3523	W3462	L3402	A3342	L3222	A3162	E3102	K3042
	V3714	V3654	L3524	L3524	F3463	R3403	V3343	S3223	A3163	D3103	SS043
K3822	E3715	E3655	R3595	L3525	L3464	D3404	T3344	S3224	L3164	A3104	F3044
	R3716	K3656	P3596	E3528	N3465	T3405	L3345	L3225	K3165	D3105	L3045
K3826	A3717	K3657	D3597	V3529	W3406	R3407	S3346	I3226	T3166	K3106	E3046
	A3718	V3658	L3598	F3528	D3467	K3408	L3347	N3227	L3167	L3107	F3047
E3829	A3719	Q3659	E3599	I3530	F3468	P3409	A3348	F3228	N3168	I3108	L3048
	D3720	E3660	Q3600	F3535	Q3469	Y3409	N3349	N3229	K3169	Q3109	R3049
K3844	E3721	A3661	L3601	I3536	L3470	L3410	R3350	K3230	T3170	V3110	L3050
K3845	S3722	K3662	K3602	K3537	Q3471	S3411	R3351	E3231	R3171	Y3111	Y3051
T3846	L3723	S3663	S3603	I3538	G3472	Q3412	V3352	S3232	L3172	G3112	Q3052
A3847	D3724	T3664	D3604	G3539	L3473	L3413	Q3353	I3233	T3173	V3113	S3053
L3848	E3725	E3665	L3605	D3540	K3474	K3414	G3354	H3234	E3174	A3114	L3054
Q3849	R3726	V3666	T3606	K3541	W3475	T3415	L3355	E3235	L3175	T3115	L3055
	V3727	K3667	K3607	E3542	L3476	R3416	A3356	D3236	K3176	D3116	H3056
F3869	K3728	L3668	Q3608	C3543	K3477	I3417	S3357	C3237	K3177	K3117	R3057
	N3729	N3669	Q3609	L3551	N3478	P3418	E3358	L3238	F3178	V3118	H3058
L3872	L3730	E3670	N3610	L3552	K3479	R3419	N3359	K3239	R3179	S3119	R3059
K3873	A3731	G3671	G3611	H3554	Y3480	T3420	V3360	A3240	S3180	R3120	K3060
L3874	D3732	R3672	F3612	L3553	E3481	P3421	R3361	I3241	P3181	E3121	E3061
G3875	S3733	E3673	K3613	H3554	E3482	A3422	W3362	R3242	P3182	K3122	L3062
S3876	I3734	K3674	L3614	T3555	D3483	L3423	A3363	P3243	L3183	A3123	K3063
K3877	T3735	Y3675	T3615	K3556	L3484	R3424	D3364	Y3244	L3184	M3124	C3064
Y3878	F3736	R3676	L3616	K3557	R3485	P3425	A3365	L3245	V3185	A3125	K3065
	S3737	P3677	K3617	A3558	W3486	L3426	V3366	Q3246	S3186	D3126	T3066
R3882	V3738	A3678	T3618	E3559	T3487	R3427	Q3367	D3247	R3187	E3127	E3067
A3883	F3739	A3679	L3619	N3559	Q3488	M3428	S3368	P3248	V3188	A3128	R3068
L3884	Q3740	A3680	E3620	F3560	I3489	L3429	F3369	E3249	S3189	E3129	L3069
F3886	Y3741	R3681	D3621	H3562	Q3490	M3430	K3370	F3250	A3190	Q3130	E3070
A3887	T3742	A3682	S3622	Y3562	Q3491	D3431	Q3371	N3251	A3191	K3131	N3071
T3888	I3743	S3683	L3623	Q3563	K3492	D3432	Q3372	P3252	V3192	V3132	G3072
S3889	R3744	L3684	L3624	F3564	Q3493	A3433	E3373	E3253	M3193	A3133	L3073
F3890	G3745	L3685	R3625	E3565	Y3494	D3434	R3374	F3254	V3194	V3134	L3074
L3746	L3746	Y3686	R3626	L3566	L3495	V3435	T3375	V3255	L3195	I3135	K3075
F3747	L3747	L3627	L3627	Q3567	A3436	A3436	L3376	A3256	M3196	M3136	L3076
		S3628	S3628	A3568	L3497	A3437	C3377	T3257	A3197	L3137	H3077
	Y3754	N3689	Q3629	Q3569	L3498	W3438	Q3378	K3258	P3198	E3138	S3078
L3755	L3755	V3690	A3630	A3570	E3499	Q3439	D3379	S3259	R3199	V3139	T3079
A3756	A3756	S3691	S3631	T3571	Q3500	N3440	L3380	Y3260	G3200	K3140	S3080
Q3757	L3758	L3692	G3632	L3572	A3501	E3441	L3381	A3261	R3201	Q3141	A3081
T3759	L3759	S3693	N3633	I3573	L3502	G3442	L3382	A3262	V3202	K3142	Q3082
F3760	F3760	K3694	F3634	N3574	E3503	P3444	T3383	A3263	P3203	Q3143	V3083
Q3761	Q3761	L3695	L3635	F3575	A3504	R3444	T3384	G3264	K3144	K3144	D3084
I3762	I3762	H3696	G3636	T3576	G3505	A3445	A3385	L3265	D3205	D3145	D3085
L3763	L3763	E3697	E3637	T3578	V3508	R3446	F3386	C3266	R3206	C3146	L3086
L3764	L3764	M3698	E3638	R3579	L3509	R3447	L3387	S3267	W3208	E3147	K3087
M3765	M3765	Y3699	F3639	R3580	L3511	M3448	L3388	W3268	W3209	E3148	A3088
N3766	N3766	Q3700	L3640	G3581		S3449	Y3389	V3269	K3209	D3149	K3089
		F3701	V3641			V3450	L3390	I3270	A3210	L3150	L3090

S3904	S3905	P3906	G3906	V3907	D3908	F3909	L3910	K3911	D3912	V3913	E3914	S3915	Q3916	G3917	R3918	K3919	L3920	G3921	Y3922	T3923	F3924	R3925	K3926	Q3927	K3928	F3929	H3930	R3931	Y3932	S3933	L3934	G3935	Q3936	G3937	Q3938	E3939	V3940	V3941	A3942	E3943	A3944	A3945	L3946	D3947	L3948	A3949	A3950	K3951	K3952	G3953	H3954	K3955	V3956	I3957	L3958	Q3959	K3960	I3961	H3962	L3963
V3964	A3965	K3966	V3967	L3968	S3969	T3970	L3971	K3972	V3973	K3974	L3975	E3976	E3977	H3978	S3979	E3980	N3981	S3982	H3983	P3984	E3985	F3986	R3987	V3988	F3989	M3990	S3991	A3992	E3993	P3994	A3995	P3996	S3997	P3998	E3999	G4000	H4001	I4002	I4003	P4004	Q4005	G4006	I4007	L4008	E4009	N4010	S4011	I4012	K4013	I4014	T4015	N4016	E4017	M4022	N4025	L4026	H4027			
K4028	A4029	L4030	D4031	M4032	F4033	T4034	Q4035	D4036	T4037	L4038	E4039	M4040	E4041	E3977	S4042	R4043	E4044	T4045	E4046	F4047	K4048	S4049	I4050	F4052	A4053	L4054	A4055	Y4056	F4057	H4058	A4059	V4060	V4061	A4062	E4063	R4064	R4065	K4066	F4067	Q4070	G4071	M4072	N4073	R4074	S4075	Y4076	P4077	F4078	M4079	T4080	G4081	D4082	L4083	T4084	I4085	S4086	V4087	M4088		
V4089	L4090	Y4091	M4092	F4093	L4094	E4095	A4096	M4097	A4098	K4099	V4100	P4101	Y4102	D4103	D4104	L4105	R4106	Y4107	L4108	F4109	G4110	E4111	T4112	M4113	Y4114	G4115	G4116	H4117	T4118	T4119	D4120	D4121	N4122	D4123	R4124	R4125	L4126	C4127	R4128	T4129	Y4130	L4131	G4132	E4133	F4134	I4135	R4136	P4137	E4138	M4139	L4140	E4141	G4142	E4143	L4144	S4145	E4219	L4146	A4147	P4148
G4149	F4150	P4151	L4152	P4153	G4154	N4155	M4156	D4157	Y4158	N4159	G4160	Y4161	H4162	Q4163	Y4164	I4165	D4166	A4167	E4168	L4169	P4170	P4171	E4172	S4173	P4174	Y4175	L4176	Y4177	G4178	L4179	H4180	P4181	M4182	A4183	E4184	V4189	L4200	E4201	L4202	Q4203	P4204	D4206	S4207	Q4208	A4209	R4210	D4211	E4212	G4213	G4214	A4215	T4216	R4217	E4218	E4219	K4220	V4221			
K4222	A4223	L4224	L4225	E4226	E4227	L4228	E4240	L4241	M4242	A4243	K4244	V4245	E4246	E4247	R4248	T4249	P4250	Y4251	V4252	V4253	V4254	F4256	Q4257	E4258	R4271	S4272	E4275	L4276	E4277	L4278	Q4279	L4280	K4281	G4282	E4283	L4284	T4285	M4286	T4287	S4288	H4289	M4290	E4291	M4292	L4293	Q4294	M4295	Y4298	K4329	E4330	L4331	E4332	A4333							
M4334	T4335	G4336	D4337	F4338	T4339	M4340	P4341	S4342	T4343	V4344	M4345	L4346	F4349	F4350	M4351	P4352	Q4353	S4354	F4355	L4356	T4357	I4359	M4360	Q4361	S4362	T4363	A4364	R4365	K4366	M4367	E4368	M4369	P4370	L4371	D4372	Q4373	M4374	A4375	L4376	Q4377	C4378	D4379	M4380	T4381	E4387	F4388	R4389	S4390	P4391	P4392	R4393	G4394	A4396	Y4397	I4398					
L4401	F4402	M4403	E4404	G4405	A4406	C4407	V4408	D4409	T4410	Q4411	A4412	G4413	I4414	T4415	T4416	E4417	A4418	K4419	L4420	R4421	D4422	L4423	T4424	P4425	P4426	M4430	F4431	L4432	K4433	A4434	I4435	P4436	A4437	D4438	K4439	Q4440	D4441	C4442	R4443	S4444	V4445	Y4446	S4447	C4448	P4449	V4450	Y4451	K4452	R4456	C4457	P4458	T4459	Y4460	V4461	M4462	T4463				
F4464	M4465	L4466	K4467	T4468	K4469	E4470	M4471	P4472	S4473	K4474	M4475	V4476	L4477	A4478	G4479	V4480	A4481	L4482	L4483	L4484	Q4485	F4486																																						

• Molecule 104: Dynein axonemal heavy chain 9

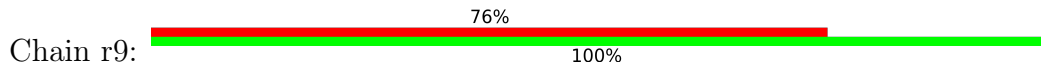

Chain r9:

M1	D63	A64	A65	E66	G67	P68	P91	F108	F197	A198	D199	S200	K201	S202	E203	T204	V205	L206	D207	S208	I209	S210	D210	L241	Q242	G243	E244	L272	T273	V274	R275	G276	M277	A278	K279	L280	L281	D282	K283	L284	Q285	S286	S287	Y288	F289	P290	A291	F292	K293	A294	M295	Y296	R297	D298	
V299	V300	A301	A304	A347	R353	S354	P355	V387	E388	Q391	E413	N414	L415	H416	T417	Y418	F419	K420	E421	N422	Q423	E424	V425	K426	E427	W428	D429	F430	Q431	S432	G527	S433	L434	G451	T455	A456	L457	F534	D458	K461	L462	G463	K464	S468	G469	V470	R471	G472	M473	A474	L475				
S476	Q477	Q478	V479	Q480	Q481	M482	H483	E484	S485	F486	Q487	E488	M489	T506	D507	F508	E509	N510	D511	V512	S513	E514	F515	N516	Q517	K518	V519	E520	D521	L522	D523	R524	S525	Q431	L526	G527	T528	I529	F530	I531	Q532	A533	F534	D535	D536	A537	P538	K545	L546	L547	D548	I549	S564	Q572	D579

A580	V581	R582	M583	I584	S586	Q587	A593	E637	S638	A639	E640	G641	K642	R643	Q646	K647	D650	T669	E672	K673	Y676	S679	Q680	P681	L682	L683	K684	R685	D686	P687	E688	T689	K690	E691	I692	T693	I694	N695	F696	N697	K716	H717	M718	F719	S728	Y732														
V736	A737	N738	L739	E740	L741	M742	A743	M744	V745	Y746	M747	K748	M750	K751	T752	L753	L754	E755	Q766	L770	E777	T778	L779	G785	I786	C787	D788	Y789	T791	E792	I793	T794	T828	K829	D830	G831	K832	R833	I694	Y1015	Y1017	V1018	S835	L836	L837	S838	L839	D840	D841	D844	Y905	E908								
N909	T910	E911	C912	K913	A914	G915	L916	T917	P918	I919	F920	E921	L926	A927	I928	P929	E930	L931	T991	R996	Q997	R998	M999	M1000	G1001	L1002	C1003	C1004	G1005	Y1006	Q1007	S1008	T1009	F1010	S1011	Q1012	Y1013	S1014	Y1015	L1016	Y1017	V1018	E1019	E1023	V1024	L1025	Q1026	F1028	L1029	L1030	Y1031	G1032	H1033							
I1034	L1035	T1036	D1037	E1038	E1039	D1046	I1048	P1049	N1050	N1051	P1052	P1053	L1054	L1055	S1056	Q1057	F1058	K1059	V1060	Q1061	D1063	S1064	Y1065	E1066	T1067	L1068	Y1069	E1070	E1071	V1072	C1073	I1074	L1075	E1076	I1077	I1078	K1079	V1080	F1081	D1082	G1083	W1084	M1085	K1086	I1087	D1088	I1089	R1090	P1091	F1092	K1093	L1096	K1108	Q1109						
H1110	L1111	V1112	D1113	H1114	V1115	T1116	H1117	S1118	L1119	A1120	M1121	L1122	D1123	A1124	F1125	I1126	K1127	S1128	S1129	E1130	S1131	Q1132	L1133	L1134	K1135	V1136	E1137	E1138	K1139	G1140	D1141	F1142	Q1143	L1144	L1145	V1146	E1147	I1148	M1149	G1150	H1151	L1152	M1153	A1154	V1155	E1156	E1157	R1158	Q1159	S1160	M1161	T1162	D1163	E1164	M1165	F1166	E1167	L1168	L1169	
K1170	Q1171	T1172	I1173	E1174	L1175	L1176	K1177	T1178	Y1179	E1180	Q1181	E1182	L1183	P1184	E1185	T1186	V1187	F1188	K1189	Q1190	L1191	E1192	E1193	L1194	P1195	M1198	M1199	L1200	I1201	K1202	L1203	V1204	A1205	L1206	T1207	V1208	K1209	Q1210	Q1211	L1212	A1213	P1214	L1215	Q1216	L1217	M1218	E1219	V1220	T1221	L1222	L1223	R1224	Q1225	R1226	C1227	T1228	A1229	F1230		
D1231	A1232	E1233	Q1234	Q1235	Q1236	F1237	W1238	E1239	Q1240	F1241	H1242	K1243	E1244	A1245	P1246	F1247	R1248	F1249	K1250	S1251	I1252	H1253	P1254	H1255	Q1256	M1257	L1258	D1259	A1260	R1261	H1262	I1263	E1264	L1265	Q1266	Q1267	M1268	E1269	S1270	T1271	M1272	A1273	S1274	L1275	S1276	E1277	S1278	A1279	I1280	L1281	F1282	E1283	V1284	L1285	N1286	V1286	P1287	D1288	Y1289	
Q1291	L1292	R1293	Q1294	C1295	R1296	K1297	E1298	L1299	C1300	Q1301	L1302	K1303	E1304	L1305	W1306	D1307	T1308	I1309	G1310	M1311	V1312	T1313	S1314	S1315	I1316	H1317	A1318	W1319	E1320	T1321	T1322	P1323	W1324	R1325	M1326	I1327	M1328	V1329	E1330	A1331	M1332	E1333	L1334	E1335	C1336	K1337	Q1338	F1339	A1340	R1341	H1342	I1343	R1344	L1345	M1346	D1347	K1348	E1349	V1350	
R1351	A1352	W1353	D1354	A1355	F1356	T1357	G1358	L1359	E1360	S1361	T1362	V1363	M1364	N1365	T1366	L1367	S1368	S1369	L1370	R1371	A1372	V1373	A1374	E1375	L1376	Q1377	N1378	P1379	A1380	I1381	R1382	E1383	R1384	H1385	W1386	R1387	Q1388	L1389	M1390	Q1391	A1392	T1393	G1394	P1395	L1396	F1397	T1398	M1399	D1400	Q1401	D1402	T1403	T1404	L1405	A1406	H1407	L1408	L1409	Q1410	
L1412	Q1413	H1414	H1415	V1416	E1417	D1418	E1419	V1420	R1421	G1422	I1423	V1424	D1425	K1426	A1427	A1428	K1429	E1430	M1431	G1432	M1433	E1434	K1435	L1436	L1437	K1438	A1439	L1440	Q1441	T1442	V1443	W1444	A1445	G1446	M1447	E1448	F1449	Q1450	Y1451	P1453	H1454	P1455	L1456	T1457	M1458	V1459	P1460	L1461	L1462	C1463	S1464	D1465	E1466	D1467	L1468	I1469	E1470			
V1471	L1472	E1473	D1474	M1475	Q1476	Q1477	Q1478	L1479	Q1480	M1481	L1482	V1483	M1484	S1485	K1486	Y1487	V1488	A1489	F1490	F1491	L1492	E1493	E1494	Y1495	S1496	G1497	W1498	Q1499	K1500	K1501	L1502	S1503	T1504	V1505	D1506	A1507	V1508	I1509	S1510	I1511	W1512	F1513	E1514	V1515	Q1516	R1517	T1518	V1519	Q1580	G1581	L1582	L1583	C1584	L1585	I1586	F1587	L1588	G1589	S1590	E1593
D1531	I1532	R1533	A1534	Q1535	L1536	P1537	Q1538	D1539	S1540	K1541	R1542	F1543	E1544	G1545	I1546	D1547	I1548	D1549	F1550	K1551	E1552	L1553	A1554	Y1555	D1556	A1557	Q1558	K1559	I1560	P1561	M1562	V1563	V1564	Q1565	T1566	T1567	M1568	K1569	P1570	G1571	L1572	Y1573	E1574	K1575	M1576	E1577	D1578	I1579	Q1580	L1581	L1582	L1583	C1584	L1585	I1586	F1587	L1588	A1589	L1590	
A1591	E1592	V1593	L1594	D1595	T1596	K1597	R1598	L1599	A1600	F1601	P1602	F1603	F1604	Y1605	F1606	L1607	S1608	S1609	S1610	D1611	L1612	L1613	D1614	I1615	L1616	S1617	M1618	K1619	T1620	A1621	P1622	Q1623	Q1624	V1625	Q1626	R1627	H1628	L1629	S1630	K1631	L1632	F1633	D1634	M1635	M1636	A1637	K1638	M1639	R1640	F1641	Q1642	L1643	D1644	A1645	S1646	G1647	E1648	P1649	T1650	

A2377	R2311	A2251	F2191	V2131	M2071	E2011	Q1951	V1891	L1831	G1771	L1711	K1651
A2378	A2312	S2252	G2192	L2132	R2072	G2012	W1952	Y1892	Y1832	D1772	F1712	T1652
I2379	M2313	M2253	I2193	K2133	S2073	F2013	F1953	V1893	S1833	R1773	D1713	S1653
W2380	L2314	E2254	I2194	V2134	L2074	I2014	S1954	F1894	Y1834	Q1774	H1714	L1654
L2316	T2315	R2255	M2195	Q2135	R2075	E2015	F1955	M1895	E1835	K1775	P1715	G1655
L2317	I2316	L2256	P2196	Q2136	D2076	A2016	L1956	C1896	Y1836	I1776	A1716	M1656
F2318	L2317	P2257	A2197	L2137	F2077	Q2017	G1957	S1897	L1837	M1777	Q1717	Y1657
M2319	F2318	L2258	T2198	E2138	M2078	S2018	E1958	E1898	G1838	T1778	V1718	S1658
M2320	D2319	M2259	E2199	E2139	I2079	L2019	E1959	Q1899	M1839	I1779	A1719	K1659
Y2321	E2200	P2260	E2200	L2140	P2080	A2020	I1960	M1900	T1840	C1780	L1720	E1660
L2322	W2201	T2261	K2202	L2141	K2081	R2021	S1961	D1901	P1841	T1781	T1721	E1661
P2323	K2203	D2203	I2203	V2143	T2083	F2023	M1963	K1903	D1843	I1783	C1723	E1662
T2324	G2204	G2204	T2084	R2144	T2084	I2024	P1964	S1904	V1844	D1784	Q1724	Y1664
C2325	L2205	L2205	D2085	H2145	D2085	T2025	S1965	C1905	I1845	H1785	I1725	A1665
L2326	F2206	F2206	D2086	S2146	D2086	L2026	V1966	G1906	T1846	A1786	W1726	F1666
L2329	S2207	E2267	S2207	V2147	M2087	Y2027	G1967	N1907	P1847	I1787	W1727	S1667
L2336	S2268	L2268	S2208	F2148	P2088	Q2028	I1968	I1908	L1848	D1788	T1728	E1668
I2337	S2269	H2270	I2209	V2149	I2089	L2029	F1969	Y1909	T1849	V1789	T1729	P1669
P2338	M2210	H2271	M2210	V2150	F2090	C2030	I1970	K1910	D1850	V1790	E1730	C1670
I2339	R2211	L2272	G2211	G2151	M2091	K2031	M1971	R1851	I1791	K1791	V1731	D1671
P2340	L2213	T2273	L2213	A2153	L2093	L2033	M1973	A1913	G1853	M1793	G1733	C1672
E2341	A2214	A2274	I2214	G2154	I2094	L2034	P1974	Q1914	I1854	I1794	A1734	G1674
Q2342	M2215	R2275	M2215	T2155	G2095	S2035	G1975	I1915	T1855	A1795	F1735	Q1675
S2343	P2216	P2276	I2216	G2156	D2096	K2036	V1976	G1916	L1856	Q1796	A1736	Q1676
M2344	T2217	A2277	T2217	K2157	L2097	Q2037	A1977	A1917	T1857	I1797	R1737	E1677
V2345	H2218	T2278	H2218	S2158	F2098	D2038	G1978	W1918	Q1858	V1798	L1738	I1678
Q2346	D2219	V2279	G2219	Q2159	P2099	H2039	R1979	G1919	S1859	D1799	E1739	M1679
M2347	D2220	S2280	V2160	Q2160	A2100	Y2040	L1980	C1920	L1860	M1900	E1740	L1680
V2348	P2221	R2281	L2161	L2161	L2101	D2041	E1981	F1921	H1861	A1801	G1741	M1681
C2349	K2222	A2282	R2162	R2162	D2102	W2042	L1982	D1922	L1862	Q1802	Y1742	H1682
H2350	W2223	G2283	S2163	G2043	V2103	G2043	P1983	E1923	T1863	A1803	E1743	V1683
L2351	I2224	I2284	L2164	L2164	P2104	L2044	E1984	F1924	M1864	F1804	S1744	L1684
E2425	L2225	L2285	H2165	H2165	R2105	R2045	M1985	M1925	S1865	L1805	A1745	G1685
T2426	L2226	Y2286	K2166	K2166	R2106	A2046	L1986	R1926	G1866	W1806	M1746	H1686
K2427	D2227	L2287	T2167	T2167	R2107	I2047	K1987	I1927	A1867	L1807	K1747	M1687
M2428	G2228	M2288	Y2168	Y2168	D2108	K2048	S1988	S1928	P1868	S1808	D1748	K1688
P2429	D2229	P2289	Q2169	Q2169	P2109	S2049	L1989	V1929	A1869	Q1809	Y1749	A1689
E2430	I2230	A2290	I2170	I2170	N2110	V2050	F1990	E1930	G1870	L1810	K1750	T1690
F2431	D2231	D2291	M2171	M2171	F2111	L2051	R1991	V1931	P1871	R1811	K1751	V1691
W2432	P2232	L2292	K2172	K2172	E2112	V2052	C1993	S1933	G1873	H1812	K1752	R1692
S2433	M2233	G2293	R2173	R2173	A2113	V2053	C1993	S1933	G1873	R1813	Q1753	H1693
K2434	W2234	W2294	R2174	R2174	L2114	A2054	A1994	V1934	T1874	W1814	V1754	E1694
L2435	I2235	M2295	P2175	P2175	V2115	G2055	M1995	V1935	G1875	D1815	A1755	M1695
V2436	E2236	E2296	V2176	V2176	R2116	S2056	V1996	A1936	L1876	D1816	Q1756	T1696
A2437	S2237	P2297	W2177	W2177	K2117	L2057	V1997	V1937	T1877	E1817	L1757	E1697
D2438	L2238	V2298	T2178	T2178	A2118	K2058	P1998	Q1938	E1878	V1818	K1758	G1698
F2439	M2239	S2299	D2179	D2179	I2119	R2059	D1999	V1939	T1879	R1819	T1759	P1699
E2440	T2240	T2240	L2180	L2180	V2120	G2060	F2000	K1940	T1880	H1820	L1760	T1700
T2441	V2241	W2301	M2181	M2181	D2121	D2061	E2001	S1941	K1881	C1821	I1761	A1701
E2442	M2242	I2302	K2183	K2183	L2122	P2062	L2002	I1942	D1882	F1822	T1762	Y1702
F2443	D2243	E2303	R2184	R2184	K2123	D2063	I2003	Q1943	L1883	A1823	M1763	E1703
E2444	D2244	K2304	A2184	A2184	L2124	R2064	C2004	D1944	G1884	M1824	L1764	E1704
M2445	M2245	R2305	V2185	V2185	Q1215	P2065	E2005	A1945	R1885	I1825	I1765	K1705
L2446	K2246	K2246	T2186	T2186	A2126	E2066	I2006	I1946	A1886	C1826	G1766	P1706
L2447	V2247	E2307	D2187	D2187	E2127	D2067	M2007	R1947	L1887	D1827	Q1767	E1707
Q2448	L2248	Q2308	M2188	M2188	D2128	Q2068	L2008	D1948	G1888	A1828	L1768	E1708
C2449	T2249	E2310	E2189	E2189	M2129	V2069	W2009	K1949	I1889	Q1829	S1769	Q1709
												W1710

L2451	V2452	H2453	T2454	S2455	E2456	T2457	I2458	R2459	V2460	C2461	Y2462	F2463	L2464	E2465	R2466	L2467	H2468	A2469	R2470	Q2471	R2472	F2473	V2474	H2475	G2476	V2477	G2478	T2479	A2480	G2481	T2482	G2483	S2484	V2485	L2486	L2487	V2488	G2489	A2490	K2491	A2492	A2493	S2494	L2495	D2496	F2497	E2498	A2499	Y2500	L2501	V2502	K2503	R2504	V2505	P2506	F2507	H2508	Y2509	V2510	
T2511	T2512	S2513	A2514	M2515	L2516	A2518	V2519	L2520	E2521	K2522	P2523	L2524	E2525	K2526	L2527	A2528	G2529	R2530	N2531	Y2532	G2533	P2534	R2535	G2536	N2537	K2538	K2539	L2540	I2541	Y2542	F2543	I2544	D2545	D2546	M2547	N2548	M2549	P2550	E2551	V2552	D2553	A2554	L2555	G2556	T2557	V2558	Q2559	P2560	H2561	T2562	I2563	R2564	R2565	Q2566	H2567	L2568	D2569	Y2570		
G2571	H2572	W2573	Y2574	R2575	S2577	K2578	L2579	S2580	L2581	K2582	E2583	L2584	T2585	N2586	V2587	Q2588	Y2589	V2590	S2591	C2592	M2593	N2594	T2595	P2596	A2597	G2598	S2599	P2600	T2601	L2602	N2603	P2604	R2605	L2606	Q2607	R2608	H2609	P2610	S2611	V2612	F2613	V2614	L2615	S2616	L2617	F2618	P2619	G2620	D2621	A2622	L2623	S2624	S2625	L2626	Y2627	S2628	L2629	I2630		
L2631	T2632	Q2633	H2634	M2639	F2640	F2641	A2642	S2643	L2644	Q2645	K2646	S2647	I2648	P2649	P2650	L2651	I2652	D2653	L2654	A2655	L2656	A2657	F2658	H2659	Q2660	K2661	I2662	A2663	T2664	T2665	F2666	L2667	P2668	T2669	G2670	K2671	F2672	F2673	H2674	L2675	L2676	F2677	M2678	L2679	R2680	D2681	F2682	A2683	N2684	L2685	F2686	Q2687	S2693	V2694	E2695	C2696	L2697	I2698	L2699	A2901
K2698	S2699	T2700	W2701	D2702	L2703	I2704	R2705	L2706	Y2707	L2708	S2711	M2712	Y2715	R2716	D2717	M2718	M2719	V2720	L2721	A2722	L2723	A2724	F2725	R2726	L2727	F2728	D2729	K2730	I2731	Q2732	T2733	E2734	L2735	L2736	K2737	L2738	T2739	F2740	D2741	D2742	I2743	E2744	D2745	P2746	R2747	E2748	Q2749	A2820	A2821	L2822	L2823	V2824	G2825	V2826	G2827	Y2756	A2760	M2761		
Q2762	I2763	G2764	E2765	F2770	V2771	Q2772	S2773	W2774	E2775	L2776	L2777	T2778	Q2779	L2780	V2781	V2782	E2783	A2784	L2785	E2786	N2787	H2788	I2789	E2790	V2791	N2792	L2793	V2794	D2795	L2797	V2798	L2799	F2800	E2801	D2802	A2803	N2804	R2805	H2806	L2813	L2814	F2817	R2818	G2819	N2820	A2821	L2822	L2823	V2824	G2825	V2826	G2827	Q2828	S2829						
S2842	S2843	M2844	D2845	V2846	F2847	Q2848	I2849	T2850	L2851	R2852	K2853	G2854	T2855	Q2856	I2857	Q2858	F2859	R2860	K2861	M2862	D2863	L2864	A2865	H2866	L2867	C2868	L2869	K2870	G2872	V2873	K2874	N2875	L2876	N2877	T2878	R2879	F2880	L2881	M2882	T2883	D2884	A2885	Q2886	V2887	A2888	D2889	E2890	R2891	F2892	L2893	V2894	L2895	L2896	N2897	D2898	L2900	A2901			
S2902	G2903	E2904	I2905	P2906	D2907	L2908	Y2909	S2910	D2911	E2912	E2913	V2914	E2915	N2916	I2917	L2918	S2919	N2920	V2921	R2922	N2923	E2924	V2925	K2926	S2927	Q2928	G2929	L2930	V2931	D2932	N2933	R2934	E2935	M2936	C2937	W2938	N2939	F2940	G2941	L2942	D2943	R2944	I2945	R2946	R2947	Q2948	L2949	K2950	T2951	L2952	L2953	C2954	F2955	S2956	P2957	V2958	G2959	M2960	K2961	
L2962	R2963	V2964	R2965	S2966	R2967	K2968	F2969	P2970	A2971	I2972	V2973	M2974	C2975	T2976	A2977	I2978	H2979	W2980	V2981	W2984	P2985	Q2986	Q2987	A2988	L2989	E2990	S2991	V2992	S2993	L2994	R2995	F2996	L2997	Q2998	N2999	T3000	E3001	G3002	L3003	E3004	P3005	T3006	V3007	K3008	Q3009	S3010	I3011	S3012	K3013	F3014	M3015	A3016	F3017	H3018	T3019	S3020	S3021	V3022		
N3023	Q3024	T3025	S3026	Q3027	S3028	Y3029	L3030	S3031	N3032	E3033	Q3034	R3035	Y3036	N3037	Y3038	T3039	T3040	P3041	K3042	S3043	F3044	L3045	E3046	F3047	I3048	R3049	L3050	Y3051	Q3052	S3053	L3054	L3055	H3056	R3057	H3058	R3059	K3060	E3061	L3062	K3063	C3064	K3065	T3066	E3067	R3068	L3069	E3070	N3071	G3072	L3073	L3074	K3075	L3076	H3077	S3078	T3079	S3080	A3081	Q3082	
V5083	D3084	D3085	L3086	K3087	A3088	K3089	L3090	A3091	A3092	Q3093	E3094	V5095	E3096	L3097	K3098	Q3099	K3100	M3101	E3102	D3103	A3104	D3105	K3106	L3107	I3108	Q3109	V3110	V3111	G3112	V3113	E3114	T3115	D3116	K3117	V3118	S3119	R3120	E3121	K3122	A3123	M3124	A3125	D3126	E3127	S3128	E3129	Q3130	K3131	V3132	A3133	V3134	I3135	M3136	L3137	E3138	V3139	G3200	K3140	Q3141	K3142
Q3143	K3144	D3145	C3146	S3147	E3148	D3149	L3150	A3151	K3152	A3153	E3154	P3155	A3156	L3157	T3158	A3159	A3160	Q3161	A3162	A3163	L3164	N3165	T3166	L3167	N3168	K3169	T3170	N3171	L3172	T3173	E3174	L3175	K3176	S3177	F3178	G3179	S3180	P3181	P3182	L3183	A3184	V3185	S3186	N3187	V3188	S3189	A3190	A3191	V3192	M3193	V3194	L3195	M3196	A3197	P3198	R3199	G3200	R3201	V3202	
F3203	K3204	D3205	R3206	S3207	K3208	R3209	A3210	K3211	K3212	V3213	T3214	R3215	K3216	R3217	V3218	D3219	G3220	F3221	L3222	D3223	S3224	L3225	I3226	R3227	N3228	N3229	K3230	E3231	N3232	L3233	H3234	E3235	S3236	C3237	L3238	K3239	A3240	I3241	R3242	F3243	Y3244	L3245	Q3246	D3247	E3248	F3249	N3250	R3251	E3252	F3253	V3254	V3255	T3257	K3258	S3259	Y3260	A3261	A3262		

F4077	E4009	A3949	A3887	A3756	D3691	S3631	T3571	E3503	L3443	I3383	R3323	A3263
F4078	M4010	A3950	T3888	Q3757	L3692	G3632	L3572	A3504	P3444	T3384	F3324	G3264
M4011	S4011	K3951	S3889	L3758	S3693	M3633	I3573	G3505	A3445	A3385	E3325	L3265
I4012	I4012	K3952	F3890	T3759	K3694	F3634	N3574	V3507	D3446	F3386	K3326	C3266
K4013	E3891	G3953	E3891	F3760	I3695	L3635	F3575	V3508	R3447	S3387	A3327	S3267
I4014	E3892	H3954	E3892	Q3761	H3696	G3636	T3576	L3509	M3448	S3388	V3328	M3268
T4015	S3893	M3955	S3893	I3762	P3697	E3637	V3577	I3510	S3449	Y3389	A3329	V3269
M4016	G3894	V3956	G3894	L3763	M3698	T3638	T3578	E3511	V3450	L3390	D3330	I3270
M4025	P3895	I3957	P3895	L3764	Y3699	V3639	R3579	M3512	E3451	K3391	K3331	N3271
L4026	A3896	M3765	A3896	M3766	Q3700	L3640	G3580	L3513	N3452	L3392	L3332	I3272
H4027	T3897	R3767	T3897	R3768	F3701	G3641	G3581	E3514	A3453	F3393	K3333	V3273
K4028	P3898	E3767	P3898	E3768	S3702	E3642	L3582	L3454	T3454	T3394	C3394	R3274
A4029	M3899	V3769	M3899	K3643	L3703	L3644	E3583	L3455	I3455	T3395	Q3336	F3276
L4030	F3901	N3770	F3901	E3645	K3704	L3644	Q3584	I3517	L3456	K3396	Q3336	Y3275
D4031	I3902	A3771	I3902	I3646	A3705	E3646	Q3585	P3519	N3458	R3398	A3338	V3278
F4033	L3903	E3772	L3903	I3647	F3706	T3647	L3586	V3520	C3459	Q3399	E3339	F3279
T4034	S3904	E3773	S3904	K3648	S3707	K3648	A3588	L3521	E3460	S3400	V3340	C3280
Q4035	D3908	L3774	D3908	Q3649	V3709	Q3649	A3589	R3521	R3461	L3401	T3341	D3281
A4036	P3909	D3775	P3909	T3650	F3710	T3650	V3590	G3522	N3462	L3402	A3342	V3282
T4037	L3910	E3808	L3910	A3651	Q3711	A3651	V3591	P3523	Q3463	D3403	V3343	E3283
L4038	K3911	E3809	K3911	A3652	K3712	A3652	S3592	L3524	L3464	R3404	T3344	R3284
E4039	D3912	G3819	D3912	E3653	A3713	E3653	K3593	L3525	M3465	T3405	I3345	K3285
M4040	V3913	S3820	V3913	V3654	V3714	V3654	E3594	G3526	V3466	W3406	S3346	K3286
C4041	E3914	S3821	E3914	E3655	E3715	E3655	R3595	V3529	D3467	R3407	L3347	Q3287
S4042	S3915	A3822	S3915	K3656	R3716	K3656	F3596	I3530	P3468	A3408	A3348	Q3288
R4043	Q3916	K3822	Q3916	K3657	A3717	K3657	D3597	K3531	Q3469	Y3409	N3349	L3289
E4044	G3917	S3823	G3917	V3658	A3718	V3658	E3599	F3535	L3470	L3410	R3350	N3290
T4045	R3918	N3824	R3918	Q3659	P3719	Q3659	Q3600	Q3472	Q3471	S3411	L3351	K3291
E4046	K3919	K3825	K3919	E3660	D3720	E3660	L3601	I3536	G3472	Q3412	V3352	A3292
F4047	L3920	K3826	L3920	A3661	E3721	A3661	L3601	K3537	I3473	L3413	G3353	T3293
K4048	G3921	E3829	G3921	K3662	S3722	K3662	S3603	I3538	K3474	K3414	G3354	A3294
S4049	Y3922	E3841	Y3922	V3664	L3723	V3664	D3604	D3540	W3475	T3415	L3355	D3295
I4050	T3923	E3841	T3923	E3665	R3724	E3665	L3605	D3542	K3477	I3417	S3357	T3297
F4052	F3924	N3844	F3924	E3666	E3725	E3666	T3606	E3542	N3478	P3418	N3359	A3298
A4053	N3925	K3845	N3925	E3667	R3726	E3667	L3606	C3543	Y3479	V3419	N3359	Q3299
L4054	Q3927	T3846	Q3927	I3668	V3727	I3668	Q3608	R3550	K3480	T3420	V3360	A3300
C4055	N3928	A3847	N3928	N3669	N3729	N3669	N3610	G3481	G3481	P3421	R3361	E3301
Y4056	F3929	L3848	F3929	E3670	L3730	E3670	G3611	E3482	E3482	A3422	W3362	K3302
F4057	H3930	Q3849	H3930	A3671	I3731	A3671	G3613	D3483	D3483	L3423	A3363	L3303
H4058	N3931	F3859	N3931	E3673	S3733	E3673	K3613	L3484	L3484	D3424	D3364	A3304
A4059	V3932	E3872	V3932	H3674	D3732	H3674	L3614	H3554	R3485	P3425	A3365	A3305
V4060	S3933	K3873	S3933	Y3675	I3734	Y3675	T3615	V3555	V3486	L3426	V3366	I3306
W4061	L3934	L3874	L3934	R3676	F3736	R3676	L3616	K3557	T3487	M3428	Q3367	K3307
A4062	G3935	G3875	G3935	P3677	S3737	P3677	K3617	A3558	Q3488	R3427	N3368	A3308
E4063	Q3936	G3876	Q3936	A3678	T3738	A3678	T3618	I3559	I3489	L3429	F3369	K3309
R4064	G3937	G3877	G3937	E3679	V3739	E3679	L3619	P3560	G3490	M3430	K3370	I3310
R4065	Q3938	K3877	Q3938	A3680	Q3740	A3680	E3620	H3561	K3492	D3431	Q3371	A3311
K4066	E3939	Y3878	E3939	R3681	I3741	R3681	D3621	Y3562	G3493	A3433	E3373	H3312
Q4070	V3940	G3881	V3940	A3682	T3742	A3682	S3622	Q3563	Y3494	D3434	R3374	N3314
G4071	H4001	R3882	G4071	L3743	R3744	L3743	L3623	P3564	L3495	V3435	T3375	E3315
W4072	I4003	A3883	W4072	G3745	L3684	L3684	S3625	E3565	Q3496	A3436	L3376	N3316
M4073	P4004	A3944	M4073	L3746	L3685	L3685	R3625	L3566	I3497	A3437	C3377	L3317
R4074	Q4005	D3884	R4074	F3687	Y3686	Y3686	R3626	Q3567	T3498	W3438	G3378	A3318
S4075	L4006	F3886	S4075	F3747	L3746	L3746	L3627	A3568	E3499	Q3439	D3379	K3319
Y4076	I4007	L3754	Y4076	L3755	S3628	S3628	S3629	Q3569	Q3500	N3440	I3380	F3319
R4136	L4008	L3948	R4136	L3948	M3689	M3689	A3630	A3570	L3502	G3442	L3382	T3321

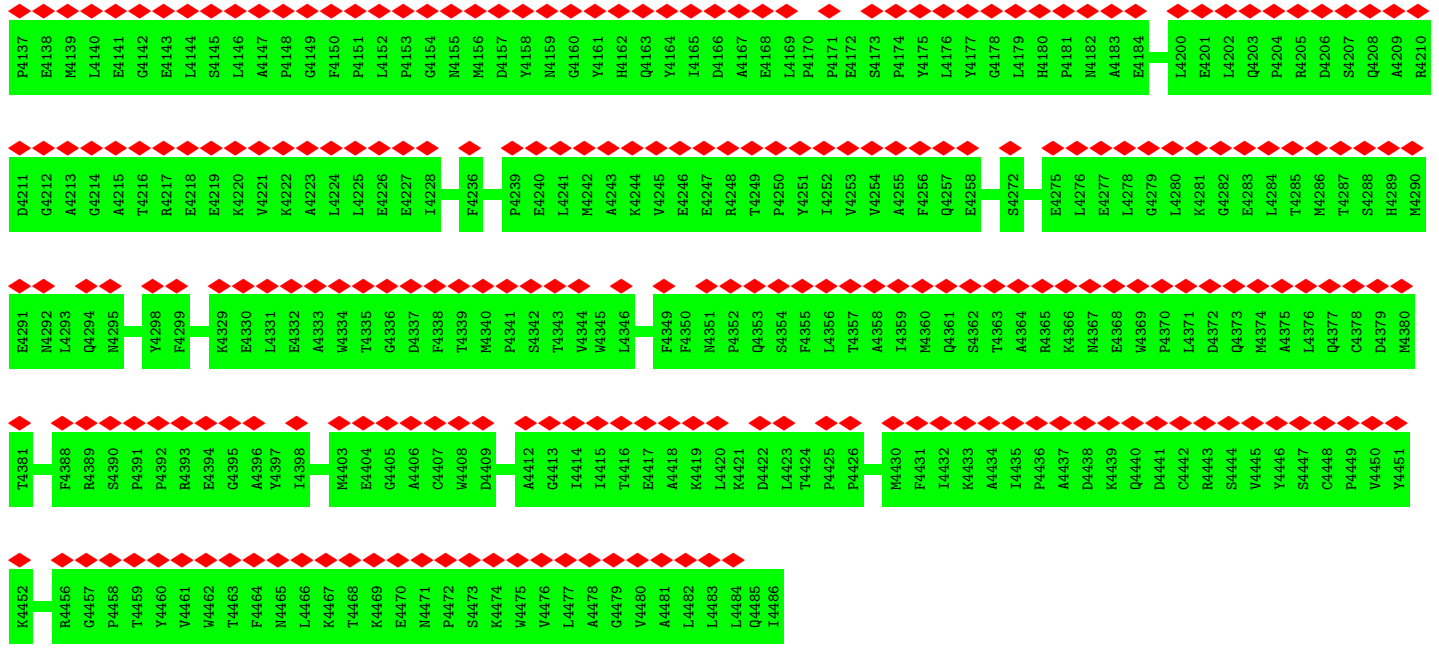

● Molecule 104: Dynein axonemal heavy chain 9

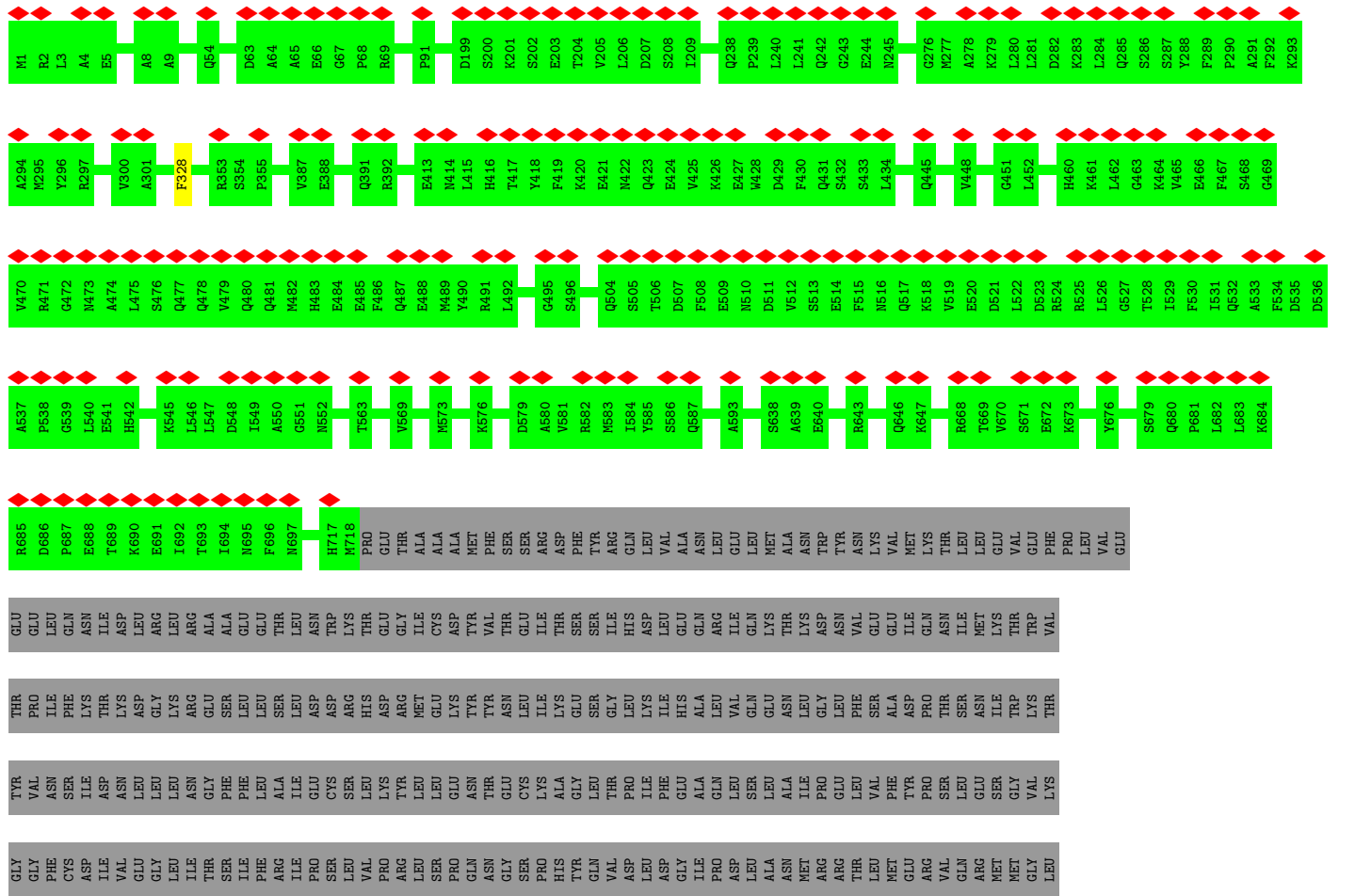

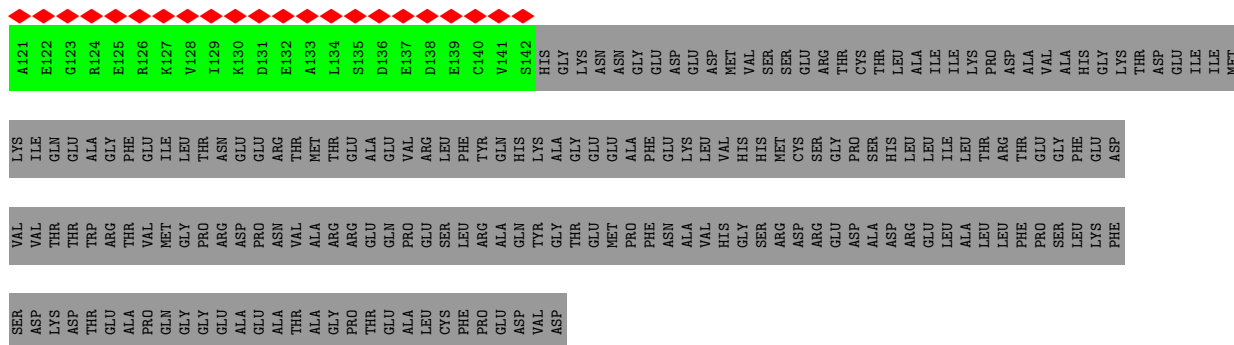

● Molecule 106: Leucine-rich repeat-containing protein 34



4 Experimental information

Property	Value	Source
EM reconstruction method	SINGLE PARTICLE	Depositor
Imposed symmetry	POINT, Not provided	
Number of particles used	90482	Depositor
Resolution determination method	FSC 0.143 CUT-OFF	Depositor
CTF correction method	PHASE FLIPPING AND AMPLITUDE CORRECTION	Depositor
Microscope	FEI TITAN KRIOS	Depositor
Voltage (kV)	300	Depositor
Electron dose ($e^-/\text{\AA}^2$)	60	Depositor
Minimum defocus (nm)	800	Depositor
Maximum defocus (nm)	2000	Depositor
Magnification	Not provided	
Image detector	GATAN K3 BIOQUANTUM (6k x 4k)	Depositor
Maximum map value	23.857	Depositor
Minimum map value	0.000	Depositor
Average map value	0.313	Depositor
Map value standard deviation	1.129	Depositor
Recommended contour level	3.0	Depositor
Map size (\AA)	848.03, 885.02, 1093.26	wwPDB
Map dimensions	619, 646, 798	wwPDB
Map angles ($^\circ$)	90.0, 90.0, 90.0	wwPDB
Pixel spacing (\AA)	1.37, 1.37, 1.37	Depositor

5 Model quality i

5.1 Standard geometry i

The Z score for a bond length (or angle) is the number of standard deviations the observed value is removed from the expected value. A bond length (or angle) with $|Z| > 5$ is considered an outlier worth inspection. RMSZ is the root-mean-square of all Z scores of the bond lengths (or angles).

There are no protein, RNA or DNA chains available to summarize Z scores of covalent bonds and angles.

Chiral center outliers are detected by calculating the chiral volume of a chiral center and verifying if the center is modelled as a planar moiety or with the opposite hand. A planarity outlier is detected by checking planarity of atoms in a peptide group, atoms in a mainchain group or atoms of a sidechain that are expected to be planar.

Mol	Chain	#Chirality outliers	#Planarity outliers
1	0	0	1
11	1Y	0	2
17	2Y	0	1
23	4H	0	1
23	4J	0	1
25	4T	0	1
34	6C	0	1
34	6I	0	1
34	6K	0	1
42	AM	0	1
42	CM	0	1
42	CU	0	1
42	DC	0	1
42	EK	0	1
42	EM	0	1
42	GQ	0	1
42	HK	0	1
42	LE	0	1
42	OC	0	1
42	PA	0	1
42	RW	0	1
42	SI	0	1
43	BD	0	1
43	BL	0	1
43	BX	0	1
43	CL	0	1
43	DB	0	1

Continued on next page...

Continued from previous page...

Mol	Chain	#Chirality outliers	#Planarity outliers
43	DF	0	1
43	DX	0	1
43	DZ	0	1
43	EV	0	1
43	FV	0	1
43	HV	0	1
43	JH	0	1
43	KF	0	1
43	LR	0	1
43	MD	0	1
43	NL	0	1
43	OF	0	1
43	ON	0	1
43	PV	0	1
43	QJ	0	1
43	SL	0	1
43	SX	0	1
43	UL	0	1
43	UZ	0	1
43	VN	0	1
43	WH	0	1
43	WL	0	1
45	j	0	1
47	N	0	1
58	b1	0	1
58	b2	0	1
64	d2	0	2
67	d8	0	1
67	f1	0	1
68	e5	0	1
70	g1	0	2
71	g2	0	2
73	g5	0	2
74	g6	0	5
75	h2	0	1
77	i1	0	1
78	i2	0	1
80	i4	0	1
82	i9	0	2
84	j3	0	2
89	q4	0	1
92	k9	0	2

Continued on next page...

Continued from previous page...

Mol	Chain	#Chirality outliers	#Planarity outliers
97	q2	0	1
99	o6	0	1
101	m8	0	1
102	u9	0	1
103	n0	0	1
103	r0	0	3
104	n9	0	1
104	p9	0	2
104	r9	0	1
104	t9	0	1
All	All	0	94

There are no bond length outliers.

There are no bond angle outliers.

There are no chirality outliers.

All (94) planarity outliers are listed below:

Mol	Chain	Res	Type	Group
1	0	175	ARG	Sidechain
11	1Y	61	ARG	Peptide,Sidechain
17	2Y	64	ASP	Peptide
23	4H	54	PRO	Peptide
23	4J	54	PRO	Peptide
25	4T	123	PHE	Peptide
34	6C	131	ARG	Sidechain
34	6I	55	HIS	Peptide
34	6K	131	ARG	Sidechain
42	AM	105	ARG	Sidechain
43	BD	282	ARG	Sidechain
43	BL	323	MET	Peptide
43	BX	271	ALA	Peptide
43	CL	322	SER	Peptide
42	CM	338	LYS	Peptide
42	CU	339	ARG	Sidechain
43	DB	271	ALA	Peptide
42	DC	339	ARG	Sidechain
43	DF	271	ALA	Peptide
43	DX	271	ALA	Peptide
43	DZ	271	ALA	Peptide
42	EK	221	ARG	Sidechain
42	EM	172	TYR	Peptide

Continued on next page...

Continued from previous page...

Mol	Chain	Res	Type	Group
43	EV	322	SER	Peptide
43	FV	271	ALA	Peptide
42	GQ	121	ARG	Sidechain
42	HK	339	ARG	Sidechain
43	HV	271	ALA	Peptide
43	JH	276	ARG	Sidechain
43	KF	343	GLU	Peptide
42	LE	422	ARG	Sidechain
43	LR	323	MET	Peptide
43	MD	86	ARG	Sidechain
47	N	38	ASP	Sidechain
43	NL	271	ALA	Peptide
42	OC	64	ARG	Sidechain
43	OF	322	SER	Peptide
43	ON	271	ALA	Peptide
42	PA	390	ARG	Sidechain
43	PV	271	ALA	Peptide
43	QJ	404	ASP	Peptide
42	RW	2	ARG	Sidechain
42	SI	55	GLU	Peptide
43	SL	271	ALA	Peptide
43	SX	271	ALA	Peptide
43	UL	271	ALA	Peptide
43	UZ	390	ARG	Peptide
43	VN	323	MET	Peptide
43	WH	86	ARG	Sidechain
43	WL	325	GLU	Peptide
58	b1	62	PHE	Peptide
58	b2	17	MET	Peptide
64	d2	1105	GLU	Peptide
64	d2	904	CYS	Peptide
67	d8	207	GLU	Peptide
68	e5	2	ILE	Peptide
67	f1	176	ALA	Peptide
70	g1	2202	MET	Peptide
70	g1	2436	SER	Peptide
71	g2	252	LEU	Peptide
71	g2	637	ALA	Peptide
73	g5	1445	LEU	Peptide
73	g5	339	THR	Peptide
74	g6	1089	GLU	Peptide
74	g6	1169	TRP	Peptide

Continued on next page...

Continued from previous page...

Mol	Chain	Res	Type	Group
74	g6	1702	ARG	Sidechain
74	g6	2027	PRO	Peptide
74	g6	893	GLN	Peptide
75	h2	811	ARG	Sidechain
77	i1	485	ARG	Sidechain
78	i2	78	ARG	Sidechain
80	i4	384	MET	Peptide
82	i9	1694	MET	Peptide
82	i9	1701	LEU	Peptide
45	j	260	LYS	Peptide
84	j3	141	GLU	Peptide
84	j3	268	GLN	Peptide
92	k9	2488	PRO	Peptide
92	k9	3757	TYR	Peptide
101	m8	207	ARG	Sidechain
103	n0	392	LYS	Peptide
104	n9	2507	PHE	Peptide
99	o6	234	ARG	Sidechain
104	p9	327	GLU	Peptide
104	p9	4457	GLY	Peptide
97	q2	26	GLU	Peptide
89	q4	78	ILE	Peptide
103	r0	2909	ARG	Sidechain
103	r0	3933	LYS	Peptide
103	r0	3953	ARG	Peptide
104	r9	995	ARG	Sidechain
104	t9	328	PHE	Peptide
102	u9	240	ARG	Sidechain

5.2 Too-close contacts [i](#)

Due to software issues we are unable to calculate clashes - this section is therefore empty.

5.3 Torsion angles [i](#)

5.3.1 Protein backbone [i](#)

There are no protein backbone outliers to report in this entry.

5.3.2 Protein sidechains [i](#)

There are no protein residues with a non-rotameric sidechain to report in this entry.

5.3.3 RNA [i](#)

There are no RNA molecules in this entry.

5.4 Non-standard residues in protein, DNA, RNA chains [i](#)

There are no non-standard protein/DNA/RNA residues in this entry.

5.5 Carbohydrates [i](#)

There are no monosaccharides in this entry.

5.6 Ligand geometry [i](#)

Of 859 ligands modelled in this entry, 285 are monoatomic - leaving 574 for Mogul analysis.

There are no bond length outliers.

There are no bond angle outliers.

There are no chirality outliers.

There are no torsion outliers.

There are no ring outliers.

No monomer is involved in short contacts.

5.7 Other polymers [i](#)

There are no such residues in this entry.

5.8 Polymer linkage issues [i](#)

There are no chain breaks in this entry.

6 Map visualisation [i](#)

This section contains visualisations of the EMDB entry EMD-35888. These allow visual inspection of the internal detail of the map and identification of artifacts.

No raw map or half-maps were deposited for this entry and therefore no images, graphs, etc. pertaining to the raw map can be shown.

6.1 Orthogonal projections [i](#)

The images above show the map projected in three orthogonal directions.

6.2 Central slices [i](#)

The images above show central slices of the map in three orthogonal directions.

6.3 Largest variance slices [i](#)

The images above show the largest variance slices of the map in three orthogonal directions.

6.4 Orthogonal standard-deviation projections (False-color) [i](#)

The images above show the map standard deviation projections with false color in three orthogonal directions. Minimum values are shown in green, max in blue, and dark to light orange shades represent small to large values respectively.

6.5 Orthogonal surface views [i](#)

The images above show the 3D surface view of the map at the recommended contour level 3.0. These images, in conjunction with the slice images, may facilitate assessment of whether an appropriate contour level has been provided.

6.6 Mask visualisation [i](#)

This section was not generated. No masks/segmentation were deposited.

7 Map analysis [i](#)

This section contains the results of statistical analysis of the map.

7.1 Map-value distribution [i](#)

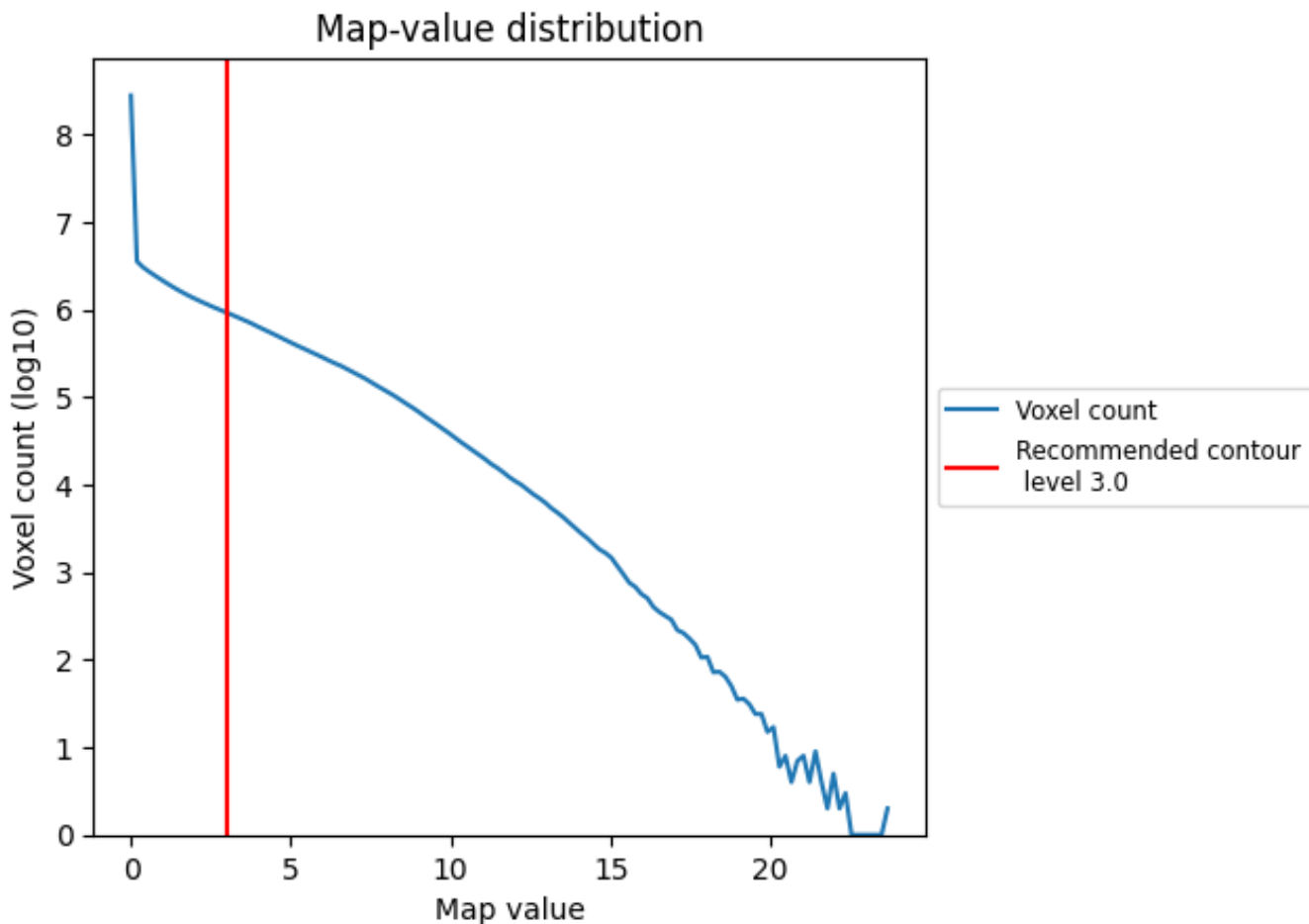

The map-value distribution is plotted in 128 intervals along the x-axis. The y-axis is logarithmic. A spike in this graph at zero usually indicates that the volume has been masked.

7.2 Volume estimate [\(i\)](#)

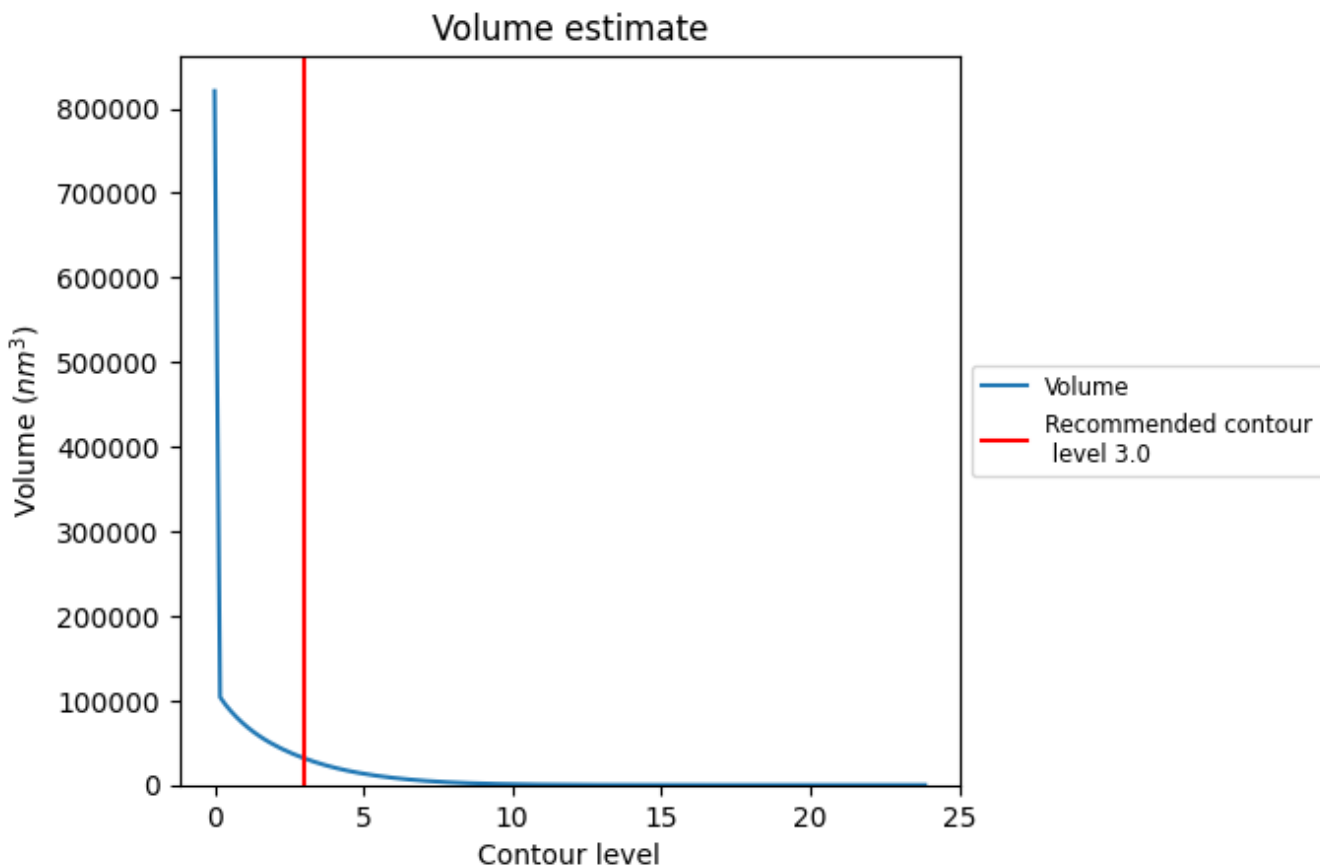

The volume at the recommended contour level is 31677 nm³; this corresponds to an approximate mass of 28615 kDa.

The volume estimate graph shows how the enclosed volume varies with the contour level. The recommended contour level is shown as a vertical line and the intersection between the line and the curve gives the volume of the enclosed surface at the given level.

7.3 Rotationally averaged power spectrum [\(i\)](#)

This section was not generated. The rotationally averaged power spectrum is only generated for cubic maps.

8 Fourier-Shell correlation

This section was not generated. No FSC curve or half-maps provided.

9 Map-model fit

This section contains information regarding the fit between EMDB map EMD-35888 and PDB model 8J07. Per-residue inclusion information can be found in section 3 on page 141.

The images above show the 3D surface view of the map at the recommended contour level 3.0 at 50% transparency in yellow overlaid with a ribbon representation of the model coloured in blue. These images allow for the visual assessment of the quality of fit between the atomic model and the map.

9.1 Q-score mapped to coordinate model [i](#)

This section was not generated.

The images above show the model with each residue coloured according to its atom inclusion. This shows to what extent they are inside the map at the recommended contour level (3.0).

9.2 Atom inclusion [i](#)

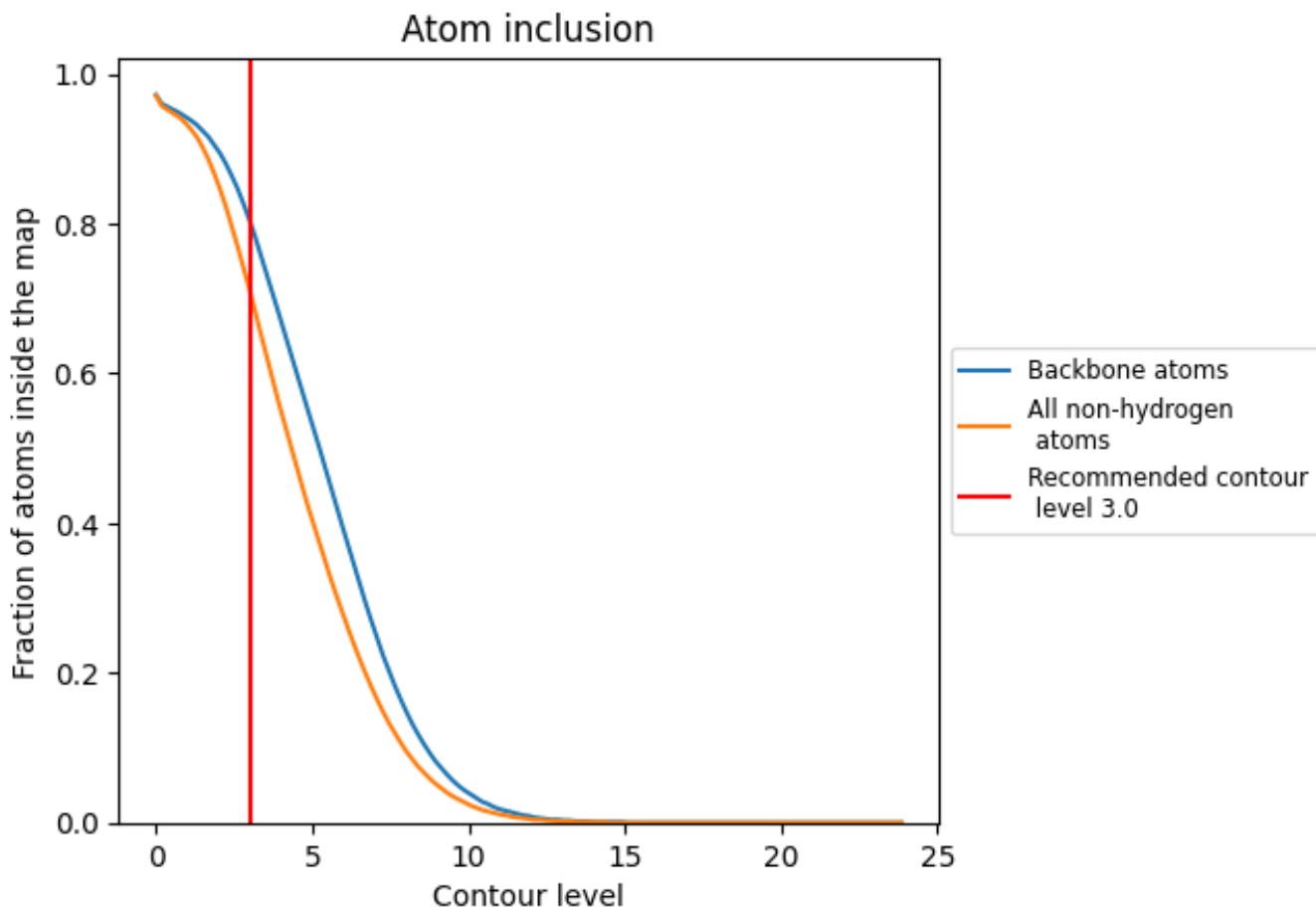

At the recommended contour level, 80% of all backbone atoms, 71% of all non-hydrogen atoms, are inside the map.

9.3 Map-model fit summary











































The table lists the average atom inclusion at the recommended contour level (3.0) and Q-score for the entire model and for each chain.

Chain	Atom inclusion
All	0.7110
0	0.5630
1	0.4760
10	0.4370
11	0.1150
12	0.2450
13	0.1800
14	0.2660
1A	0.6540
1B	0.6620
1C	0.6960
1D	0.4570
1E	0.5410
1F	0.5470
1G	0.6150
1H	0.5700
1I	0.5260
1J	0.5440
1L	0.7500
1M	0.7650
1N	0.7420
1O	0.7440
1P	0.7620
1Q	0.7290
1R	0.6540
1S	0.6340
1T	0.6660
1V	0.6120
1W	0.6000
1Y	0.6950
1Z	0.7140
2	0.5030
2A	0.8260
2B	0.8360
2C	0.8330













































Continued on next page...

Continued from previous page...

Chain	Atom inclusion
2D	 0.8450
2E	 0.8450
2F	 0.8390
2G	 0.8350
2I	 0.6710
2J	 0.6760
2L	 0.6680
2M	 0.7300
2N	 0.6780
2O	 0.7230
2Q	 0.6090
2R	 0.6020
2S	 0.6220
2U	 0.7460
2V	 0.7710
2W	 0.7610
2X	 0.7690
2Y	 0.7720
2Z	 0.7600
3	 0.8170
3A	 0.7950
3B	 0.8040
3C	 0.7580
3D	 0.7950
3E	 0.7740
3F	 0.7540
3G	 0.7120
3H	 0.7060
3I	 0.7060
3J	 0.7290
3K	 0.7340
3L	 0.5840
3M	 0.7090
3O	 0.6500
3P	 0.6620
3Q	 0.6930
3R	 0.6640
3S	 0.6610
3T	 0.7030
3U	 0.6520
3W	 0.6030
3X	 0.5930











































Continued on next page...

Continued from previous page...

Chain	Atom inclusion
3Y	 0.5900
4	 0.5530
4A	 0.6430
4B	 0.1460
4C	 0.5460
4D	 0.2550
4E	 0.6330
4F	 0.1130
4G	 0.6020
4H	 0.1740
4I	 0.5900
4J	 0.3880
4K	 0.4360
4L	 0.0520
4M	 0.5090
4O	 0.7180
4P	 0.7110
4Q	 0.7120
4R	 0.6940
4S	 0.7390
4T	 0.7360
4U	 0.5590
4V	 0.5420
4W	 0.7210
5	 0.0510
5A	 0.7510
5B	 0.7580
5C	 0.7660
5D	 0.4100
5E	 0.4320
5F	 0.3880
5H	 0.6490
5I	 0.6630
5J	 0.7020
5L	 0.7250
5M	 0.7290
5O	 0.7170
5P	 0.7090
5Q	 0.6940
5R	 0.6800
5S	 0.7080
5T	 0.6960











































Continued on next page...

Continued from previous page...

Chain	Atom inclusion
5U	 0.6880
5V	 0.7680
5X	 0.7180
5Y	 0.7000
6A	 0.5690
6C	 0.3700
6E	 0.5350
6G	 0.3420
6I	 0.3140
6K	 0.2640
6L	 0.5660
6N	 0.3700
6O	 0.5410
6Q	 0.4590
6R	 0.4220
6T	 0.2890
6V	 0.5660
7	 0.4620
7A	 0.3630
7B	 0.3190
7C	 0.2100
7D	 0.5340
7E	 0.3840
7F	 0.4580
7G	 0.3630
7I	 0.6780
7J	 0.6630
8	 0.0020
8A	 0.7190
8B	 0.6910
8C	 0.6750
8D	 0.6960
8E	 0.7110
8F	 0.7090
8G	 0.6920
8H	 0.7820
8J	 0.4840
8K	 0.1900
8L	 0.1990
8M	 0.2260
8N	 0.3440
8O	 0.2610











































Continued on next page...

Continued from previous page...

Chain	Atom inclusion
8P	 0.2090
8Q	 0.4620
9	 0.5000
A	 0.7900
AB	 0.8810
AC	 0.8880
AD	 0.8780
AE	 0.8840
AF	 0.8950
AG	 0.9010
AH	 0.8730
AI	 0.8770
AJ	 0.8720
AK	 0.8760
AL	 0.8800
AM	 0.8900
AN	 0.8730
AO	 0.8920
AP	 0.8840
AQ	 0.9010
AR	 0.8860
AS	 0.8890
AT	 0.8890
AU	 0.8870
AV	 0.8730
AW	 0.8830
AX	 0.8820
AY	 0.8900
AZ	 0.9030
B	 0.7380
BA	 0.8610
BB	 0.8670
BC	 0.8590
BD	 0.8570
BE	 0.8500
BF	 0.8720
BG	 0.8750
BH	 0.8740
BI	 0.8660
BJ	 0.8500
BK	 0.8390
BL	 0.8410











































Continued on next page...

Continued from previous page...

Chain	Atom inclusion
BM	 0.8610
BN	 0.8580
BO	 0.8570
BP	 0.8650
BQ	 0.8640
BR	 0.8670
BS	 0.8430
BT	 0.8420
BU	 0.8190
BV	 0.7820
BW	 0.8230
BX	 0.8610
BY	 0.8690
C	 0.7310
CB	 0.8710
CC	 0.8660
CD	 0.8620
CE	 0.8120
CF	 0.8420
CG	 0.8590
CH	 0.8580
CI	 0.8530
CJ	 0.8330
CK	 0.8420
CL	 0.8400
CM	 0.8490
CN	 0.8610
CO	 0.8520
CP	 0.8660
CQ	 0.8640
CR	 0.8800
CS	 0.8710
CT	 0.8560
CU	 0.8180
CV	 0.7680
CW	 0.8500
CX	 0.8490
CY	 0.8550
CZ	 0.8370
D	 0.9810
DB	 0.8580
DC	 0.8520











































Continued on next page...

Continued from previous page...

Chain	Atom inclusion
DD	 0.8680
DE	 0.8010
DF	 0.8460
DG	 0.8420
DH	 0.8730
DI	 0.8610
DJ	 0.8220
DK	 0.8370
DL	 0.8680
DM	 0.8470
DN	 0.8630
DO	 0.8480
DP	 0.8580
DQ	 0.8600
DR	 0.8930
DS	 0.8770
DT	 0.8790
DU	 0.8430
DV	 0.7870
DW	 0.8320
DX	 0.8590
DY	 0.8460
DZ	 0.8480
E	 0.5560
EB	 0.8170
EC	 0.8160
ED	 0.8470
EE	 0.7910
EF	 0.8090
EG	 0.8130
EH	 0.8340
EI	 0.8080
EJ	 0.7650
EK	 0.7790
EL	 0.8280
EM	 0.8190
EN	 0.8280
EO	 0.8230
EP	 0.8250
EQ	 0.8260
ER	 0.8440
ES	 0.8230

Continued on next page...

Continued from previous page...

Chain	Atom inclusion
ET	 0.8350
EU	 0.7890
EV	 0.7690
EW	 0.7800
EX	 0.8190
EY	 0.8100
EZ	 0.8230
F	 0.6970
FB	 0.8150
FC	 0.8260
FD	 0.8400
FE	 0.7940
FF	 0.7610
FG	 0.7820
FH	 0.7860
FI	 0.7820
FJ	 0.7010
FK	 0.7430
FL	 0.8250
FM	 0.8360
FN	 0.8260
FO	 0.8210
FP	 0.8290
FQ	 0.8440
FR	 0.8340
FS	 0.8300
FT	 0.8100
FU	 0.7820
FV	 0.7420
FW	 0.7860
FX	 0.8160
FY	 0.8260
FZ	 0.8140
G	 0.8630
GB	 0.8100
GC	 0.7990
GD	 0.8280
GE	 0.8020
GF	 0.8330
GG	 0.8210
GH	 0.8040
GI	 0.7910











































Continued on next page...

Continued from previous page...

Chain	Atom inclusion
GJ	0.7640
GK	0.7790
GL	0.8150
GM	0.8140
GN	0.8110
GO	0.7960
GP	0.8100
GQ	0.8290
GR	0.8190
GS	0.8180
GT	0.8090
GU	0.7930
GV	0.7500
GW	0.7680
GX	0.8060
GY	0.8070
GZ	0.8160
H	0.7680
HA	0.8310
HB	0.8230
HC	0.8320
HD	0.8560
HE	0.8510
HF	0.8360
HG	0.8270
HH	0.8260
HI	0.8310
HJ	0.7920
HK	0.8000
HL	0.8170
HM	0.8170
HN	0.8150
HO	0.8220
HP	0.8380
HQ	0.8400
HR	0.8300
HS	0.8290
HT	0.8250
HU	0.8070
HV	0.7900
HW	0.7950
HX	0.8170











































Continued on next page...

Continued from previous page...

Chain	Atom inclusion
HY	 0.8180
HZ	 0.8260
I	 0.8460
IA	 0.8320
IB	 0.8510
IC	 0.8520
ID	 0.8370
IE	 0.8280
IF	 0.8350
IG	 0.8100
IH	 0.7930
II	 0.8030
IJ	 0.8120
IK	 0.8200
IL	 0.8270
IM	 0.8240
IN	 0.8490
IO	 0.8430
IP	 0.8320
IQ	 0.8290
IR	 0.8240
IS	 0.8130
IT	 0.7990
IU	 0.8010
IV	 0.8140
IW	 0.8320
IX	 0.8330
IY	 0.8230
J	 0.7520
JB	 0.8300
JC	 0.8230
JD	 0.8440
JE	 0.8220
JF	 0.8200
JG	 0.8090
JH	 0.8200
JI	 0.8050
JJ	 0.8040
JK	 0.7980
JL	 0.8270
JM	 0.8190
JN	 0.8210











































Continued on next page...

Continued from previous page...

Chain	Atom inclusion
JO	 0.8270
JP	 0.8450
JQ	 0.8140
JR	 0.8240
JS	 0.8020
JT	 0.8190
JU	 0.8070
JV	 0.8210
JW	 0.8100
JX	 0.8220
JY	 0.8120
JZ	 0.8300
K	 0.3680
KB	 0.8580
KC	 0.8580
KD	 0.8720
KE	 0.8620
KF	 0.8620
KG	 0.8610
KH	 0.8720
KI	 0.8680
KJ	 0.8620
KK	 0.8580
KL	 0.8440
KM	 0.8430
KN	 0.8460
KO	 0.8560
KP	 0.8700
KQ	 0.8600
KR	 0.8550
KS	 0.8620
KT	 0.8450
KU	 0.8500
KV	 0.8450
KW	 0.8490
KX	 0.8380
KY	 0.8550
KZ	 0.8550
L	 0.6650
LB	 0.8310
LC	 0.8720
LD	 0.8610











































Continued on next page...

Continued from previous page...

Chain	Atom inclusion
LE	 0.8580
LF	 0.8570
LG	 0.8760
LH	 0.8640
LI	 0.8580
LJ	 0.8710
LK	 0.8830
LL	 0.8580
LM	 0.8450
LN	 0.8590
LO	 0.8620
LP	 0.8720
LQ	 0.8650
LR	 0.8680
LS	 0.8740
LT	 0.8610
LU	 0.8640
LV	 0.8640
LW	 0.8730
LX	 0.8550
LY	 0.8460
LZ	 0.8560
M	 0.8240
MA	 0.8770
MC	 0.8830
MD	 0.8700
ME	 0.8730
MF	 0.8660
MG	 0.8850
MH	 0.8750
MI	 0.8760
MJ	 0.8790
MK	 0.8940
ML	 0.8790
MM	 0.8700
MN	 0.8800
MO	 0.8860
MP	 0.8820
MQ	 0.8800
MR	 0.8840
MS	 0.8870
MT	 0.8810











































Continued on next page...

Continued from previous page...

Chain	Atom inclusion
MU	 0.8730
MV	 0.8910
MW	 0.8800
MX	 0.8760
MY	 0.8610
MZ	 0.8720
N	 0.6420
NA	 0.8000
NB	 0.8100
NC	 0.7980
ND	 0.8120
NE	 0.7940
NF	 0.8040
NG	 0.8000
NH	 0.7820
NI	 0.7770
NJ	 0.7850
NK	 0.7660
NL	 0.7960
NM	 0.7870
NN	 0.7990
NO	 0.7930
NP	 0.8010
NQ	 0.7900
NR	 0.7800
NS	 0.7640
NT	 0.7690
NU	 0.7680
NV	 0.7800
NW	 0.7850
NX	 0.8060
NZ	 0.7950
O	 0.5270
OA	 0.8130
OB	 0.8210
OC	 0.8210
OD	 0.8150
OE	 0.8150
OF	 0.8070
OG	 0.8010
OH	 0.7700
OI	 0.7540

Continued on next page...

Continued from previous page...

Chain	Atom inclusion
OJ	 0.7780
OK	 0.7760
OL	 0.8030
OM	 0.8060
ON	 0.8360
OO	 0.8330
OP	 0.8260
OQ	 0.8120
OR	 0.8150
OS	 0.7990
OT	 0.7780
OU	 0.7670
OV	 0.7730
OW	 0.7810
OX	 0.8140
OY	 0.8100
P	 0.6890
PA	 0.7870
PB	 0.8060
PC	 0.8150
PD	 0.8020
PE	 0.7950
PF	 0.7940
PG	 0.7690
PH	 0.7440
PI	 0.7220
PJ	 0.7400
PK	 0.7700
PL	 0.7850
PM	 0.7920
PN	 0.8080
PO	 0.8080
PP	 0.8010
PQ	 0.7990
PR	 0.8040
PS	 0.7940
PT	 0.7630
PU	 0.7270
PV	 0.7460
PW	 0.7640
PX	 0.7760
PY	 0.7890











































Continued on next page...

Continued from previous page...

Chain	Atom inclusion
Q	0.6250
QA	0.7740
QB	0.7950
QC	0.7930
QD	0.7900
QE	0.7670
QF	0.8010
QG	0.7900
QH	0.7560
QI	0.7080
QJ	0.7370
QK	0.7490
QL	0.7710
QM	0.7770
QN	0.7990
QO	0.7980
QP	0.7890
QQ	0.7900
QR	0.8180
QS	0.7940
QT	0.7740
QU	0.7220
QV	0.7300
QW	0.7490
QX	0.7770
QY	0.7730
R	0.6940
RA	0.7640
RB	0.7740
RC	0.7680
RD	0.7630
RE	0.7650
RF	0.7700
RG	0.7610
RH	0.7450
RI	0.7020
RJ	0.6980
RK	0.7340
RL	0.7540
RM	0.7650
RN	0.7770
RO	0.7710











































Continued on next page...

Continued from previous page...

Chain	Atom inclusion
RP	 0.7560
RQ	 0.7740
RR	 0.7940
RS	 0.7880
RT	 0.7640
RU	 0.7100
RV	 0.6970
RW	 0.7070
RX	 0.7540
RY	 0.7650
S	 0.6420
SB	 0.7640
SC	 0.7540
SD	 0.7670
SE	 0.7560
SF	 0.7720
SG	 0.7410
SH	 0.7470
SI	 0.7150
SJ	 0.6880
SK	 0.7060
SL	 0.7260
SM	 0.7290
SN	 0.7510
SO	 0.7610
SP	 0.7460
SQ	 0.7710
SR	 0.7920
SS	 0.7630
ST	 0.7740
SU	 0.7310
SV	 0.6940
SW	 0.7080
SX	 0.7370
SY	 0.7570
T	 0.7900
TB	 0.7750
TC	 0.7550
TD	 0.7640
TE	 0.7820
TF	 0.7830
TG	 0.7850











































Continued on next page...

Continued from previous page...

Chain	Atom inclusion
TH	 0.7630
TI	 0.7420
TJ	 0.6870
TK	 0.6830
TL	 0.7230
TM	 0.7540
TN	 0.7600
TO	 0.7440
TP	 0.7410
TQ	 0.7630
TR	 0.7890
TS	 0.7740
TT	 0.7480
TU	 0.7260
TV	 0.6920
TW	 0.7010
TX	 0.7280
TY	 0.7630
TZ	 0.7860
U	 0.6820
UB	 0.8180
UC	 0.8120
UD	 0.8080
UE	 0.8040
UF	 0.8050
UG	 0.7990
UH	 0.7970
UI	 0.7760
UJ	 0.7440
UK	 0.7400
UL	 0.7790
UM	 0.7950
UN	 0.8070
UO	 0.7900
UP	 0.7900
UQ	 0.7910
UR	 0.7990
US	 0.7860
UT	 0.7790
UU	 0.7600
UV	 0.7370
UW	 0.7630

Continued on next page...

Continued from previous page...

Chain	Atom inclusion
UX	 0.7800
UY	 0.7930
UZ	 0.8230
V	 0.3930
VB	 0.8310
VC	 0.8180
VD	 0.8280
VE	 0.8350
VF	 0.8180
VG	 0.8260
VH	 0.8300
VI	 0.8140
VJ	 0.8140
VK	 0.8200
VL	 0.8330
VM	 0.8430
VN	 0.8350
VO	 0.8250
VP	 0.8320
VQ	 0.8320
VR	 0.8250
VS	 0.8170
VT	 0.8250
VU	 0.8170
VV	 0.8180
VW	 0.8170
VX	 0.8340
VY	 0.8420
VZ	 0.8400
W	 0.3910
WA	 0.8060
WB	 0.8150
WC	 0.8150
WD	 0.7960
WE	 0.8110
WF	 0.8150
WG	 0.8300
WH	 0.8020
WI	 0.8160
WJ	 0.8250
WK	 0.8200
WL	 0.8210











































Continued on next page...

Continued from previous page...

Chain	Atom inclusion
WM	0.8090
WN	0.8150
WO	0.8250
WP	0.8050
WQ	0.8230
WR	0.8120
WS	0.8280
WT	0.7930
WU	0.8060
WV	0.8070
WW	0.8040
WX	0.8020
X	0.5930
XA	0.8640
XB	0.8590
XC	0.8310
XD	0.8770
XE	0.8530
XF	0.8650
XG	0.8870
XH	0.8670
XI	0.8870
XJ	0.8770
XK	0.8730
XL	0.8550
XM	0.8570
Y	0.4150
YB	0.8320
YC	0.7760
YD	0.8410
YF	0.8530
YG	0.8710
YH	0.8530
YI	0.8030
YJ	0.8700
YK	0.8510
YL	0.8360
YM	0.7920
Z	0.7030
a	0.3170
a0	0.7720
a1	0.4200











































Continued on next page...

Continued from previous page...

Chain	Atom inclusion
a2	 0.4160
a3	 0.3730
a4	 0.4840
a5	 0.6920
a6	 0.7270
a7	 0.5510
a8	 0.5480
a9	 0.4120
b	 0.6280
b0	 0.4920
b1	 0.4490
b2	 0.1780
b3	 0.4360
b4	 0.4610
b5	 0.3970
b6	 0.4650
b7	 0.5420
b8	 0.4420
b9	 0.4910
c	 0.6510
c0	 0.1940
c1	 0.5640
c2	 0.5210
c3	 0.6730
c4	 0.6380
c5	 0.6750
c6	 0.7330
d	 0.7400
d0	 0.4040
d1	 0.5460
d2	 0.4240
d3	 0.3150
d4	 0.3550
d5	 0.5650
d6	 0.7660
d7	 0.5850
d8	 0.3070
d9	 0.4260
e	 0.5960
e0	 0.3040
e1	 0.4780
e2	 0.5610











































Continued on next page...

Continued from previous page...

Chain	Atom inclusion
e3	 0.3010
e4	 0.1870
e5	 0.5740
e6	 0.5580
e7	 0.3920
e8	 0.4510
e9	 0.3220
f	 0.7190
f1	 0.5200
f2	 0.5120
g	 0.4930
g1	 0.4800
g2	 0.1960
g3	 0.4200
g4	 0.1990
g5	 0.3490
g6	 0.5700
h	 0.6630
h1	 0.6860
h2	 0.6390
h3	 0.6900
h4	 0.6420
i	 0.7060
i1	 0.4590
i2	 0.3890
i3	 0.3190
i4	 0.4810
i5	 0.4930
i6	 0.2530
i7	 0.2490
i8	 0.7120
i9	 0.4860
j	 0.7220
j1	 0.2130
j2	 0.2310
j3	 0.5890
j4	 0.6530
k	 0.8000
k1	 0.8580
k2	 0.9370
k3	 0.9260
k4	 0.8910











































Continued on next page...

Continued from previous page...

Chain	Atom inclusion
k5	 0.9340
k8	 0.6790
k9	 0.3900
l	 0.5450
l1	 0.8910
l2	 0.9900
l3	 0.9830
l4	 0.9890
l5	 1.0000
l6	 0.9890
l7	 0.9250
l8	 0.9970
m	 0.6980
m0	 0.4830
m1	 0.8700
m2	 0.8090
m3	 0.0000
m4	 0.9670
m5	 0.8790
m6	 0.4270
m7	 0.5200
m8	 0.4300
m9	 0.6500
n	 0.4580
n0	 0.4650
n1	 0.6220
n2	 0.8590
n3	 0.8050
n4	 0.9080
n5	 0.6080
n6	 0.8880
n7	 0.2630
n8	 0.2440
n9	 0.2400
o	 0.6860
o1	 0.8670
o2	 0.8190
o3	 0.0000
o4	 0.9870
o5	 0.8950
o6	 0.3970
o8	 0.3500

















Continued on next page...

Continued from previous page...

Chain	Atom inclusion
p	 0.7240
p0	 0.4700
p1	 0.6500
p2	 0.8330
p3	 0.8690
p4	 0.8940
p5	 0.6580
p6	 0.8910
p7	 0.2810
p8	 0.2660
p9	 0.2420
q	 0.6310
q0	 0.4690
q1	 0.8220
q2	 0.7380
q3	 0.0000
q4	 0.8980
q5	 0.7790
q6	 0.4030
q7	 0.5160
q8	 0.3880
q9	 0.6510
r	 0.6510
r0	 0.4290
r1	 0.5120
r2	 0.8120
r3	 0.6530
r4	 0.8970
r5	 0.5090
r6	 0.7810
r7	 0.2170
r8	 0.1210
r9	 0.2280
s	 0.7530
s0	 0.5000
s1	 0.8420
s2	 0.8780
s6	 0.4440
s7	 0.5350
s8	 0.4370
s9	 0.6750
t	 0.6240

Continued on next page...

Continued from previous page...

Chain	Atom inclusion
t0	 0.8400
t9	 0.6980
u	 0.5650
u0	 0.4820
u6	 0.4800
u7	 0.5170
u8	 0.5120
u9	 0.6550
v	 0.6040
v1	 0.0000
v2	 0.0000
v3	 0.0000
w	 0.4010
x	 0.7410
y	 0.5520
z	 0.8360