



# wwPDB EM Validation Summary Report ⓘ

Nov 19, 2022 – 07:58 pm GMT

PDB ID : 5IV7  
EMDB ID : EMD-3396  
Title : Cryo-electron microscopy structure of the star-shaped, hubless post-attachment T4 baseplate  
Authors : Taylor, N.M.I.; Guerrero-Ferreira, R.C.; Goldie, K.N.; Stahlberg, H.; Leiman, P.G.  
Deposited on : 2016-03-19  
Resolution : 6.77 Å (reported)  
Based on initial model : 5IV5

This is a wwPDB EM Validation Summary Report for a publicly released PDB entry.

We welcome your comments at [validation@mail.wwpdb.org](mailto:validation@mail.wwpdb.org)

A user guide is available at

<https://www.wwpdb.org/validation/2017/EMValidationReportHelp>

with specific help available everywhere you see the ⓘ symbol.

The types of validation reports are described at

<http://www.wwpdb.org/validation/2017/FAQs#types>.

---

The following versions of software and data (see [references ⓘ](#)) were used in the production of this report:

EMDB validation analysis : 0.0.1.dev43  
MolProbity : 4.02b-467  
Percentile statistics : 20191225.v01 (using entries in the PDB archive December 25th 2019)  
MapQ : 1.9.9  
Ideal geometry (proteins) : Engh & Huber (2001)  
Ideal geometry (DNA, RNA) : Parkinson et al. (1996)  
Validation Pipeline (wwPDB-VP) : 2.31.2

# 1 Overall quality at a glance i

The following experimental techniques were used to determine the structure:  
*ELECTRON MICROSCOPY*

The reported resolution of this entry is 6.77 Å.

Percentile scores (ranging between 0-100) for global validation metrics of the entry are shown in the following graphic. The table shows the number of entries on which the scores are based.

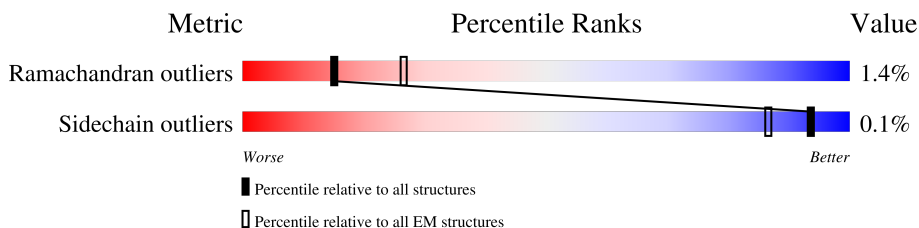

Metric	Whole archive (#Entries)	EM structures (#Entries)
Ramachandran outliers	154571	4023
Sidechain outliers	154315	3826

The table below summarises the geometric issues observed across the polymeric chains and their fit to the map. The red, orange, yellow and green segments of the bar indicate the fraction of residues that contain outliers for  $\geq 3$ , 2, 1 and 0 types of geometric quality criteria respectively. A grey segment represents the fraction of residues that are not modelled. The numeric value for each fraction is indicated below the corresponding segment, with a dot representing fractions  $\leq 5\%$ . The upper red bar (where present) indicates the fraction of residues that have poor fit to the EM map (all-atom inclusion  $< 40\%$ ). The numeric value is given above the bar.

Mol	Chain	Length	Quality of chain
1	A	660	9% (red), 98% (green), 1% (yellow), 2% (grey)
1	B	660	8% (red), 97% (green), 1% (yellow), 2% (grey)
1	BF	660	9% (red), 98% (green), 1% (yellow), 2% (grey)
1	BG	660	7% (red), 97% (green), 1% (yellow), 2% (grey)
1	EA	660	9% (red), 98% (green), 1% (yellow), 2% (grey)
1	EB	660	8% (red), 97% (green), 1% (yellow), 2% (grey)
1	Q	660	9% (red), 98% (green), 1% (yellow), 2% (grey)
1	R	660	7% (red), 97% (green), 1% (yellow), 2% (grey)
1	g	660	9% (red), 98% (green), 1% (yellow), 2% (grey)

*Continued on next page...*

Continued from previous page...

Mol	Chain	Length	Quality of chain
1	h	660	7% 97% ..
1	w	660	9% 98% .
1	x	660	8% 97% ..
2	C	1032	. 91% 6% .
2	CA	1032	. 91% 6% .
2	EC	1032	. 91% 6% .
2	S	1032	. 91% 6% .
2	i	1032	. 91% 6% .
2	y	1032	. 91% 6% .
3	AA	334	6% 97% ..
3	CB	334	. 96% ..
3	CC	334	6% 97% ..
3	D	334	. 96% ..
3	E	334	6% 97% ..
3	ED	334	. 96% ..
3	EE	334	6% 97% ..
3	T	334	. 96% ..
3	U	334	6% 97% ..
3	j	334	. 96% ..
3	k	334	6% 97% ..
3	z	334	. 96% ..
4	AB	288	14% 99% .
4	AC	288	16% 99% .
4	AD	288	22% 99% .
4	CD	288	15% 99% .

Continued on next page...

Continued from previous page...

Mol	Chain	Length	Quality of chain
4	CE	288	12% 99%
4	CF	288	24% 99%
4	EF	288	15% 99%
4	EG	288	12% 99%
4	F	288	15% 99%
4	FA	288	25% 99%
4	G	288	14% 99%
4	H	288	22% 99%
4	V	288	14% 99%
4	W	288	12% 99%
4	X	288	24% 99%
4	l	288	15% 99%
4	m	288	13% 99%
4	n	288	25% 99%
5	AE	602	15% 95% 5%
5	AF	602	20% 94% 6%
5	AG	602	16% 95% 5%
5	CG	602	14% 95% 5%
5	DA	602	20% 94% 6%
5	DB	602	16% 95% 5%
5	FB	602	14% 95% 5%
5	FC	602	19% 94% 6%
5	FD	602	17% 95% 5%
5	I	602	15% 95% 5%
5	J	602	19% 94% 6%

Continued on next page...

Continued from previous page...

Mol	Chain	Length	Quality of chain	
5	K	602	15%	95% 5%
5	Y	602	14%	95% 5%
5	Z	602	20%	94% 6%
5	a	602	16%	95% 5%
5	o	602	14%	95% 5%
5	p	602	20%	94% 6%
5	q	602	17%	95% 5%
6	BA	219	18%	98% .
6	BB	219	20%	98% .
6	BC	219	10%	98% .
6	DC	219	16%	98% .
6	DD	219	25%	98% .
6	DE	219	12%	98% .
6	FE	219	20%	98% .
6	FF	219	19%	98% .
6	FG	219	9%	98% .
6	L	219	18%	98% .
6	M	219	20%	98% .
6	N	219	10%	98% .
6	b	219	17%	98% .
6	c	219	25%	98% .
6	d	219	11%	98% .
6	r	219	20%	98% .
6	s	219	19%	98% .
6	t	219	9%	98% .

Continued on next page...

*Continued from previous page...*

Mol	Chain	Length	Quality of chain
7	BD	132	<p>65% 95% 5%</p>
7	DF	132	<p>65% 95% 5%</p>
7	GA	132	<p>64% 95% 5%</p>
7	O	132	<p>64% 95% 5%</p>
7	e	132	<p>67% 95% 5%</p>
7	u	132	<p>64% 95% 5%</p>
8	BE	196	<p>98% ..</p>
8	DG	196	<p>98% ..</p>
8	GB	196	<p>98% ..</p>
8	P	196	<p>98% ..</p>
8	f	196	<p>98% ..</p>
8	v	196	<p>98% ..</p>

## 2 Entry composition [i](#)

There are 8 unique types of molecules in this entry. The entry contains 312210 atoms, of which 0 are hydrogens and 0 are deuteriums.

In the tables below, the AltConf column contains the number of residues with at least one atom in alternate conformation and the Trace column contains the number of residues modelled with at most 2 atoms.

- Molecule 1 is a protein called Baseplate wedge protein gp6.

Mol	Chain	Residues	Atoms					AltConf	Trace
			Total	C	N	O	S		
1	A	658	Total	C	N	O	S	0	0
			5235	3308	867	1050	10		
1	B	648	Total	C	N	O	S	0	0
			5157	3259	854	1034	10		
1	Q	658	Total	C	N	O	S	0	0
			5235	3308	867	1050	10		
1	R	648	Total	C	N	O	S	0	0
			5157	3259	854	1034	10		
1	g	658	Total	C	N	O	S	0	0
			5235	3308	867	1050	10		
1	h	648	Total	C	N	O	S	0	0
			5157	3259	854	1034	10		
1	w	658	Total	C	N	O	S	0	0
			5235	3308	867	1050	10		
1	x	648	Total	C	N	O	S	0	0
			5157	3259	854	1034	10		
1	BF	658	Total	C	N	O	S	0	0
			5235	3308	867	1050	10		
1	BG	648	Total	C	N	O	S	0	0
			5157	3259	854	1034	10		
1	EA	658	Total	C	N	O	S	0	0
			5235	3308	867	1050	10		
1	EB	648	Total	C	N	O	S	0	0
			5157	3259	854	1034	10		

- Molecule 2 is a protein called Baseplate wedge protein gp7.

Mol	Chain	Residues	Atoms					AltConf	Trace
			Total	C	N	O	S		
2	C	1004	Total	C	N	O	S	0	0
			8199	5247	1347	1578	27		
2	S	1004	Total	C	N	O	S	0	0
			8199	5247	1347	1578	27		
2	i	1004	Total	C	N	O	S	0	0
			8199	5247	1347	1578	27		

*Continued on next page...*

*Continued from previous page...*

Mol	Chain	Residues	Atoms					AltConf	Trace
2	y	1004	Total	C	N	O	S	0	0
			8199	5247	1347	1578	27		
2	CA	1004	Total	C	N	O	S	0	0
			8199	5247	1347	1578	27		
2	EC	1004	Total	C	N	O	S	0	0
			8199	5247	1347	1578	27		

- Molecule 3 is a protein called Baseplate wedge protein gp8.

Mol	Chain	Residues	Atoms					AltConf	Trace
3	D	328	Total	C	N	O	S	0	0
			2631	1677	430	507	17		
3	E	332	Total	C	N	O	S	0	0
			2658	1692	434	515	17		
3	T	328	Total	C	N	O	S	0	0
			2631	1677	430	507	17		
3	U	332	Total	C	N	O	S	0	0
			2658	1692	434	515	17		
3	j	328	Total	C	N	O	S	0	0
			2631	1677	430	507	17		
3	k	332	Total	C	N	O	S	0	0
			2658	1692	434	515	17		
3	z	328	Total	C	N	O	S	0	0
			2631	1677	430	507	17		
3	AA	332	Total	C	N	O	S	0	0
			2658	1692	434	515	17		
3	CB	328	Total	C	N	O	S	0	0
			2631	1677	430	507	17		
3	CC	332	Total	C	N	O	S	0	0
			2658	1692	434	515	17		
3	ED	328	Total	C	N	O	S	0	0
			2631	1677	430	507	17		
3	EE	332	Total	C	N	O	S	0	0
			2658	1692	434	515	17		

- Molecule 4 is a protein called Baseplate wedge protein gp9.

Mol	Chain	Residues	Atoms					AltConf	Trace
4	F	288	Total	C	N	O	S	0	0
			2175	1354	366	446	9		
4	G	288	Total	C	N	O	S	0	0
			2175	1354	366	446	9		

*Continued on next page...*



*Continued from previous page...*

Mol	Chain	Residues	Atoms					AltConf	Trace
4	H	288	Total	C	N	O	S	0	0
			2175	1354	366	446	9		
4	V	288	Total	C	N	O	S	0	0
			2175	1354	366	446	9		
4	W	288	Total	C	N	O	S	0	0
			2175	1354	366	446	9		
4	X	288	Total	C	N	O	S	0	0
			2175	1354	366	446	9		
4	l	288	Total	C	N	O	S	0	0
			2175	1354	366	446	9		
4	m	288	Total	C	N	O	S	0	0
			2175	1354	366	446	9		
4	n	288	Total	C	N	O	S	0	0
			2175	1354	366	446	9		
4	AB	288	Total	C	N	O	S	0	0
			2175	1354	366	446	9		
4	AC	288	Total	C	N	O	S	0	0
			2175	1354	366	446	9		
4	AD	288	Total	C	N	O	S	0	0
			2175	1354	366	446	9		
4	CD	288	Total	C	N	O	S	0	0
			2175	1354	366	446	9		
4	CE	288	Total	C	N	O	S	0	0
			2175	1354	366	446	9		
4	CF	288	Total	C	N	O	S	0	0
			2175	1354	366	446	9		
4	EF	288	Total	C	N	O	S	0	0
			2175	1354	366	446	9		
4	EG	288	Total	C	N	O	S	0	0
			2175	1354	366	446	9		
4	FA	288	Total	C	N	O	S	0	0
			2175	1354	366	446	9		

- Molecule 5 is a protein called Baseplate wedge protein gp10.

Mol	Chain	Residues	Atoms					AltConf	Trace
5	I	602	Total	C	N	O	S	0	0
			4675	2933	779	953	10		
5	J	602	Total	C	N	O	S	0	0
			4675	2933	779	953	10		
5	K	602	Total	C	N	O	S	0	0
			4675	2933	779	953	10		

*Continued on next page...*

*Continued from previous page...*

Mol	Chain	Residues	Atoms					AltConf	Trace
5	Y	602	Total	C	N	O	S	0	0
			4675	2933	779	953	10		
5	Z	602	Total	C	N	O	S	0	0
			4675	2933	779	953	10		
5	a	602	Total	C	N	O	S	0	0
			4675	2933	779	953	10		
5	o	602	Total	C	N	O	S	0	0
			4675	2933	779	953	10		
5	p	602	Total	C	N	O	S	0	0
			4675	2933	779	953	10		
5	q	602	Total	C	N	O	S	0	0
			4675	2933	779	953	10		
5	AE	602	Total	C	N	O	S	0	0
			4675	2933	779	953	10		
5	AF	602	Total	C	N	O	S	0	0
			4675	2933	779	953	10		
5	AG	602	Total	C	N	O	S	0	0
			4675	2933	779	953	10		
5	CG	602	Total	C	N	O	S	0	0
			4675	2933	779	953	10		
5	DA	602	Total	C	N	O	S	0	0
			4675	2933	779	953	10		
5	DB	602	Total	C	N	O	S	0	0
			4675	2933	779	953	10		
5	FB	602	Total	C	N	O	S	0	0
			4675	2933	779	953	10		
5	FC	602	Total	C	N	O	S	0	0
			4675	2933	779	953	10		
5	FD	602	Total	C	N	O	S	0	0
			4675	2933	779	953	10		

- Molecule 6 is a protein called Baseplate wedge protein gp11.

Mol	Chain	Residues	Atoms					AltConf	Trace
6	L	218	Total	C	N	O	S	0	0
			1665	1056	273	334	2		
6	M	218	Total	C	N	O	S	0	0
			1665	1056	273	334	2		
6	N	218	Total	C	N	O	S	0	0
			1665	1056	273	334	2		
6	b	218	Total	C	N	O	S	0	0
			1665	1056	273	334	2		

*Continued on next page...*

*Continued from previous page...*

Mol	Chain	Residues	Atoms					AltConf	Trace
6	c	218	Total	C	N	O	S	0	0
			1665	1056	273	334	2		
6	d	218	Total	C	N	O	S	0	0
			1665	1056	273	334	2		
6	r	218	Total	C	N	O	S	0	0
			1665	1056	273	334	2		
6	s	218	Total	C	N	O	S	0	0
			1665	1056	273	334	2		
6	t	218	Total	C	N	O	S	0	0
			1665	1056	273	334	2		
6	BA	218	Total	C	N	O	S	0	0
			1665	1056	273	334	2		
6	BB	218	Total	C	N	O	S	0	0
			1665	1056	273	334	2		
6	BC	218	Total	C	N	O	S	0	0
			1665	1056	273	334	2		
6	DC	218	Total	C	N	O	S	0	0
			1665	1056	273	334	2		
6	DD	218	Total	C	N	O	S	0	0
			1665	1056	273	334	2		
6	DE	218	Total	C	N	O	S	0	0
			1665	1056	273	334	2		
6	FE	218	Total	C	N	O	S	0	0
			1665	1056	273	334	2		
6	FF	218	Total	C	N	O	S	0	0
			1665	1056	273	334	2		
6	FG	218	Total	C	N	O	S	0	0
			1665	1056	273	334	2		

- Molecule 7 is a protein called Baseplate wedge protein gp25.

Mol	Chain	Residues	Atoms					AltConf	Trace
7	O	126	Total	C	N	O	S	0	0
			1011	636	169	202	4		
7	e	126	Total	C	N	O	S	0	0
			1011	636	169	202	4		
7	u	126	Total	C	N	O	S	0	0
			1011	636	169	202	4		
7	BD	126	Total	C	N	O	S	0	0
			1011	636	169	202	4		
7	DF	126	Total	C	N	O	S	0	0
			1011	636	169	202	4		

*Continued on next page...*

*Continued from previous page...*

Mol	Chain	Residues	Atoms					AltConf	Trace
			Total	C	N	O	S		
7	GA	126	1011	636	169	202	4	0	0

- Molecule 8 is a protein called Baseplate wedge protein gp53.

Mol	Chain	Residues	Atoms					AltConf	Trace
			Total	C	N	O	S		
8	P	193	1599	1035	259	299	6	0	0
8	f	193	1599	1035	259	299	6	0	0
8	v	193	1599	1035	259	299	6	0	0
8	BE	193	1599	1035	259	299	6	0	0
8	DG	193	1599	1035	259	299	6	0	0
8	GB	193	1599	1035	259	299	6	0	0

### 3 Residue-property plots [i](#)

These plots are drawn for all protein, RNA, DNA and oligosaccharide chains in the entry. The first graphic for a chain summarises the proportions of the various outlier classes displayed in the second graphic. The second graphic shows the sequence view annotated by issues in geometry and atom inclusion in map density. Residues are color-coded according to the number of geometric quality criteria for which they contain at least one outlier: green = 0, yellow = 1, orange = 2 and red = 3 or more. A red diamond above a residue indicates a poor fit to the EM map for this residue (all-atom inclusion < 40%). Stretches of 2 or more consecutive residues without any outlier are shown as a green connector. Residues present in the sample, but not in the model, are shown in grey.

- Molecule 1: Baseplate wedge protein gp6

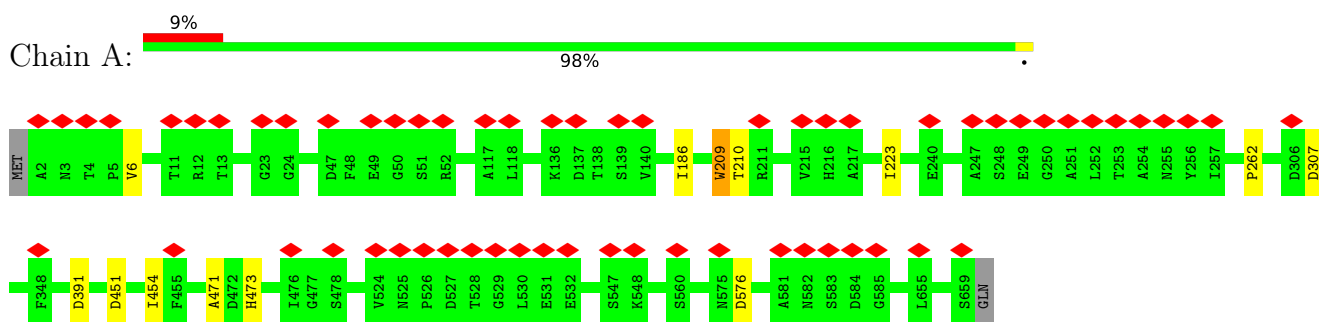

- Molecule 1: Baseplate wedge protein gp6

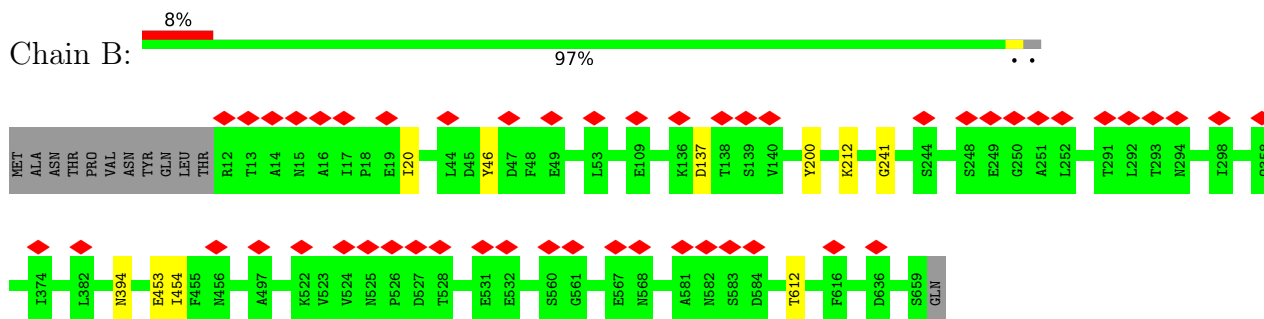

- Molecule 1: Baseplate wedge protein gp6

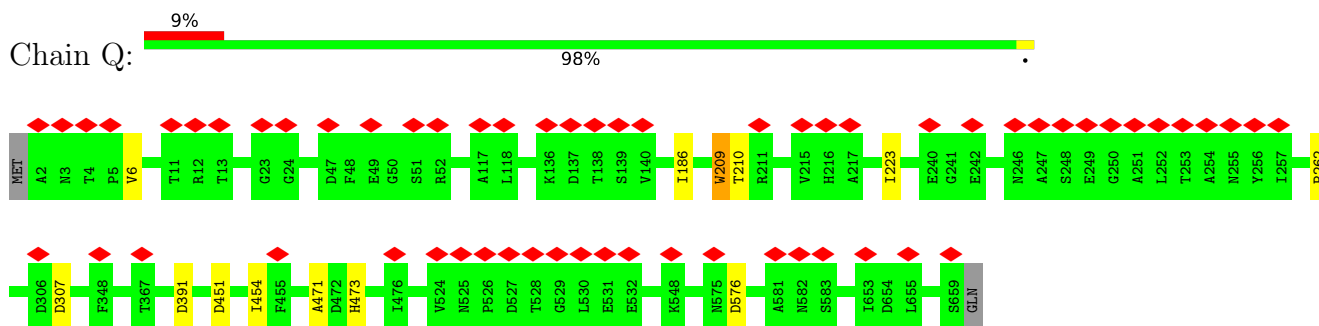

- Molecule 1: Baseplate wedge protein gp6



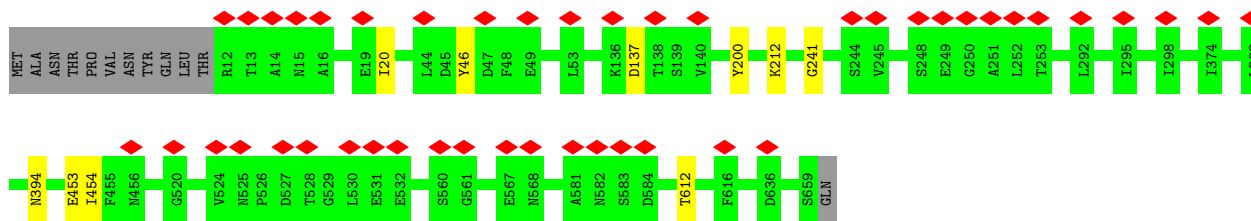

• Molecule 1: Baseplate wedge protein gp6

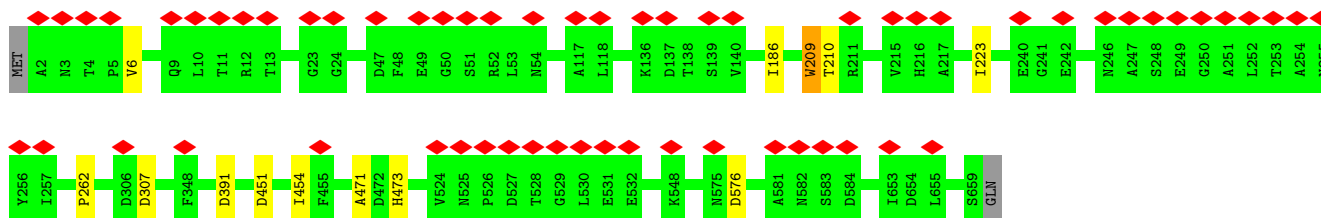

• Molecule 1: Baseplate wedge protein gp6

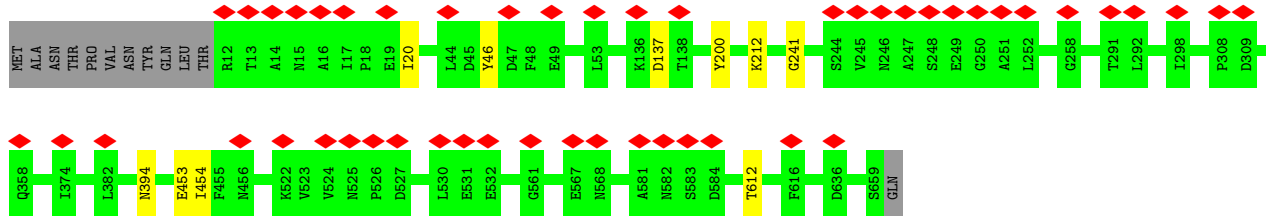

• Molecule 1: Baseplate wedge protein gp6

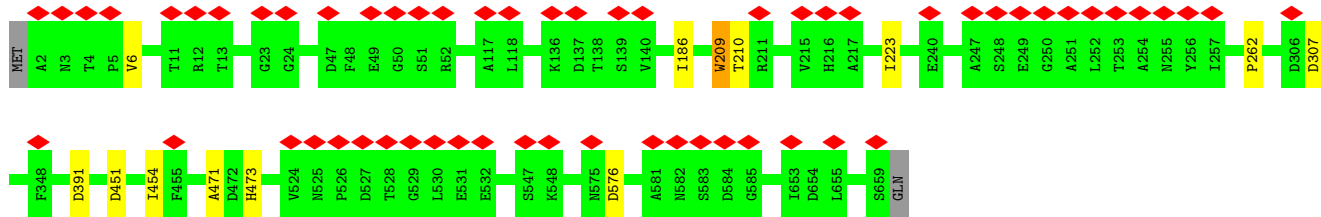

• Molecule 1: Baseplate wedge protein gp6

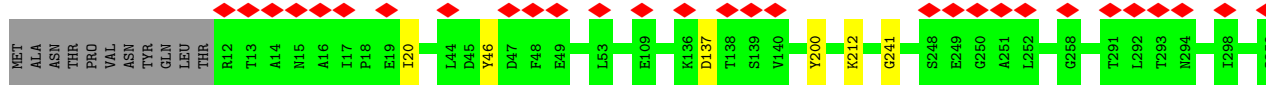

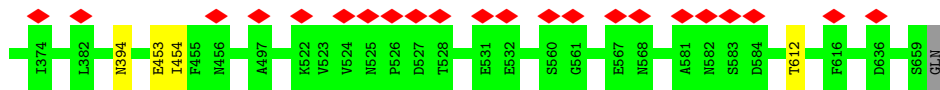

• Molecule 1: Baseplate wedge protein gp6

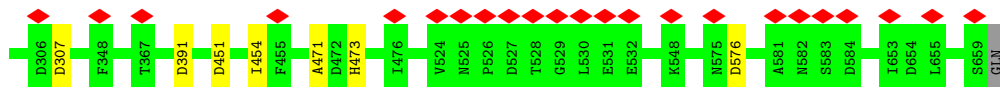
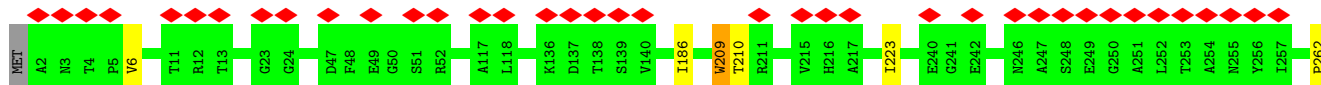

• Molecule 1: Baseplate wedge protein gp6

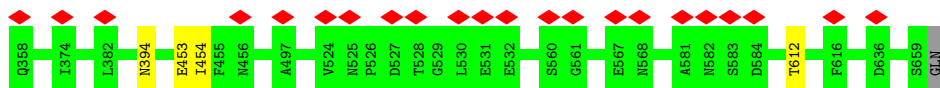
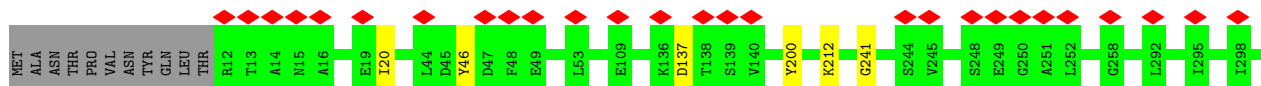

• Molecule 1: Baseplate wedge protein gp6

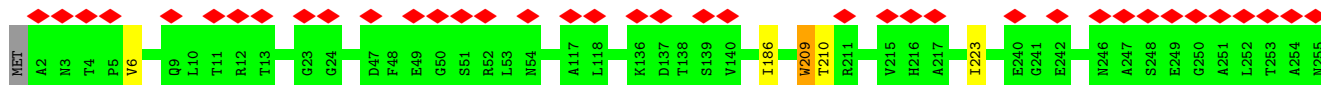

• Molecule 1: Baseplate wedge protein gp6

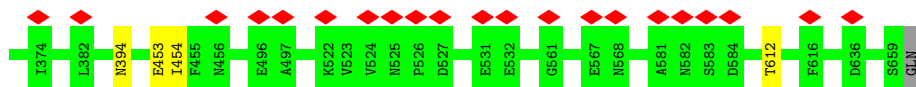
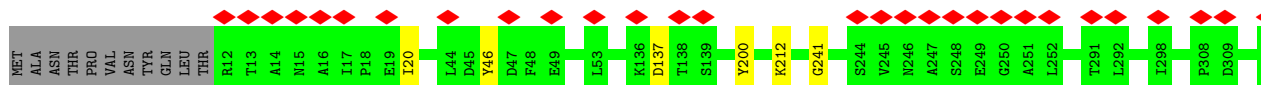

• Molecule 2: Baseplate wedge protein gp7

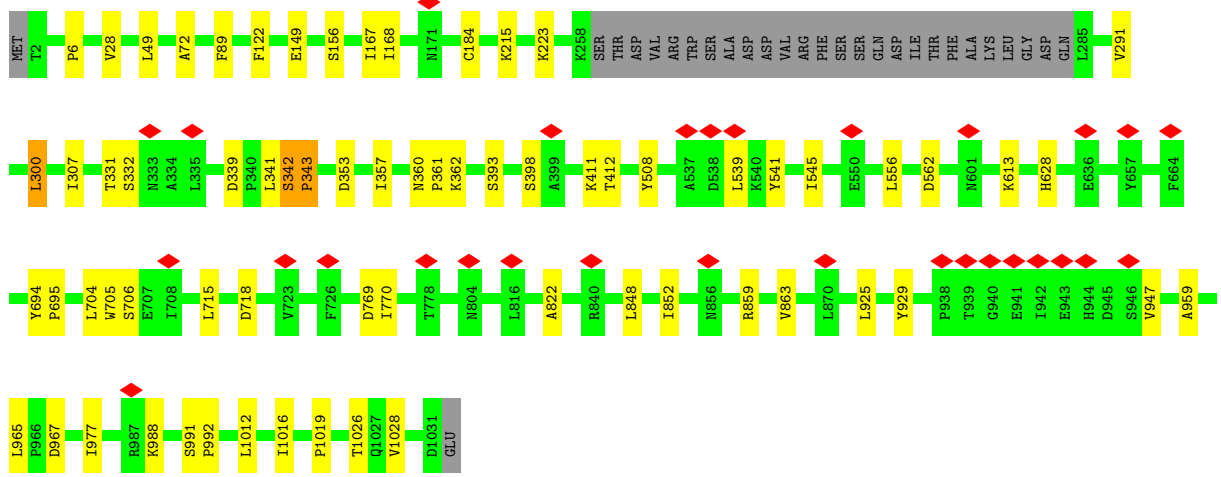
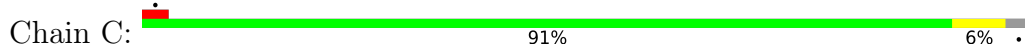

• Molecule 2: Baseplate wedge protein gp7

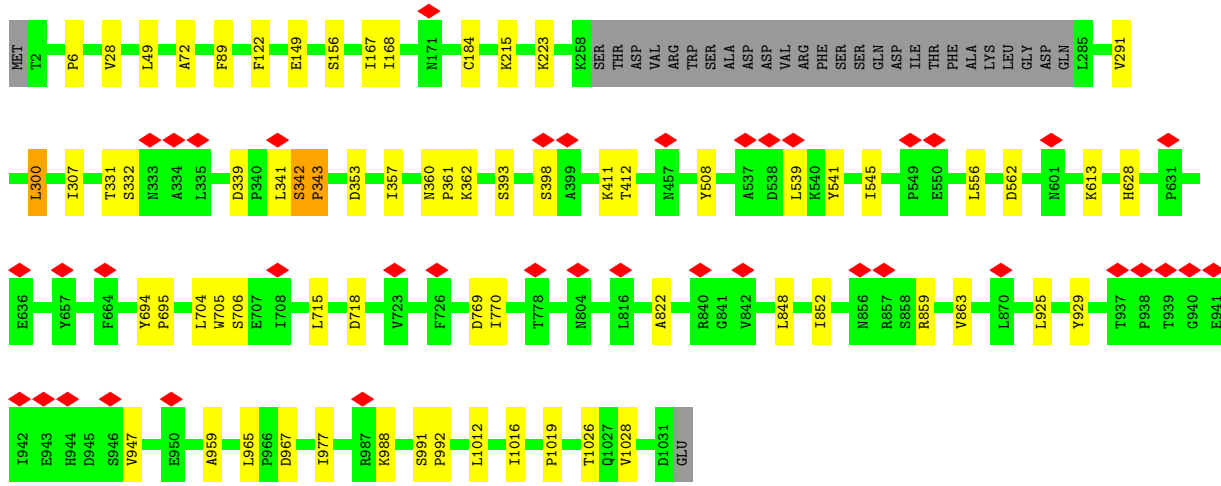
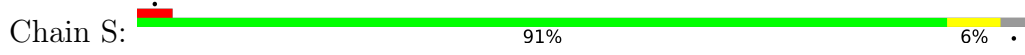

• Molecule 2: Baseplate wedge protein gp7

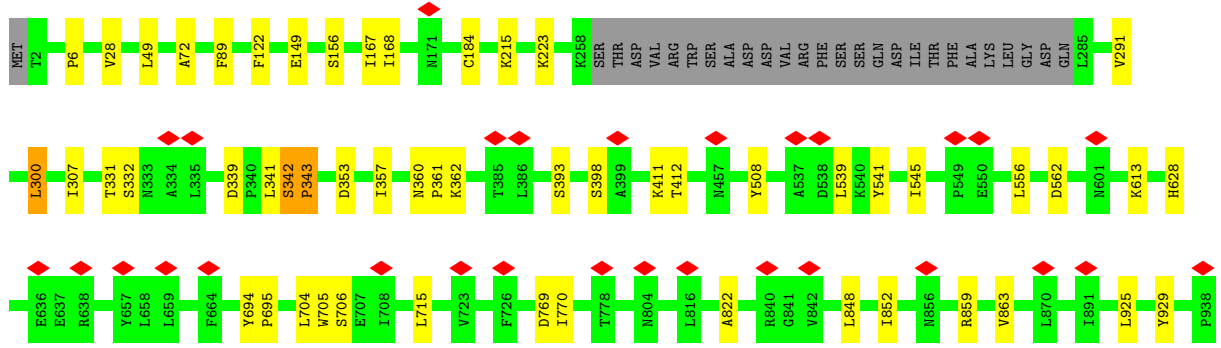
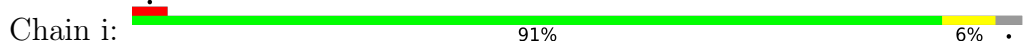



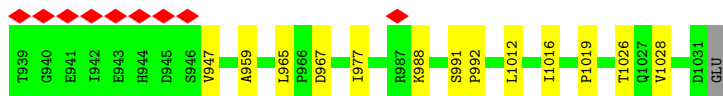

• Molecule 2: Baseplate wedge protein gp7

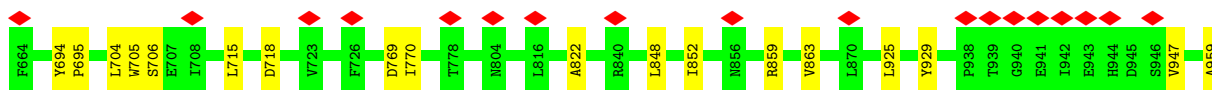
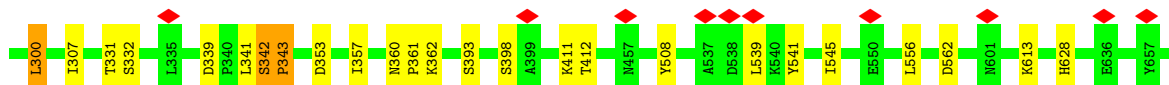
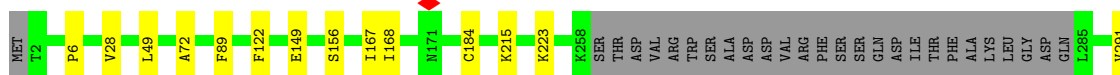

• Molecule 2: Baseplate wedge protein gp7

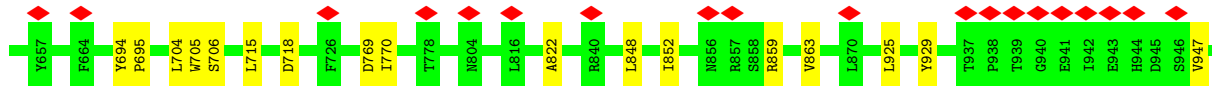
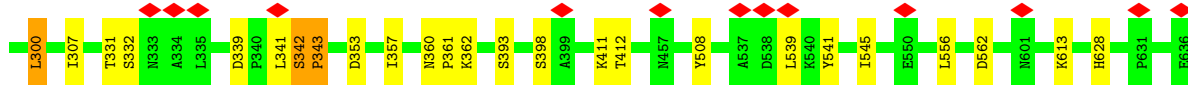
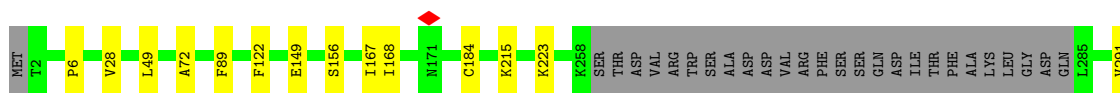

• Molecule 2: Baseplate wedge protein gp7

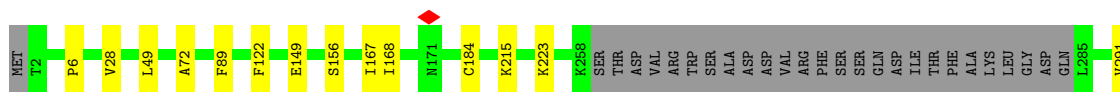

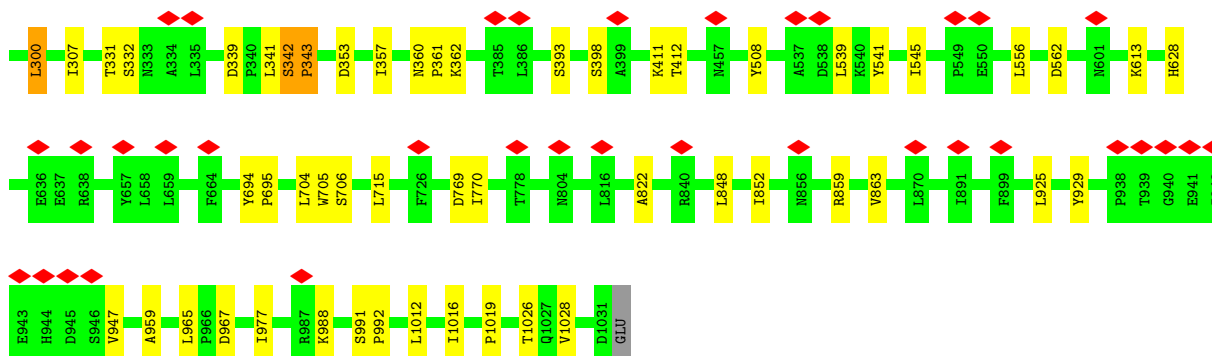

• Molecule 3: Baseplate wedge protein gp8



• Molecule 3: Baseplate wedge protein gp8

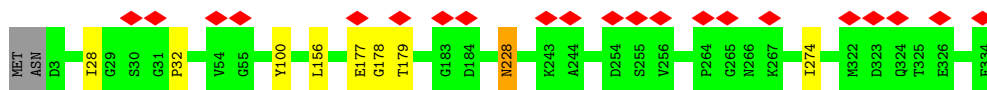

• Molecule 3: Baseplate wedge protein gp8



• Molecule 3: Baseplate wedge protein gp8

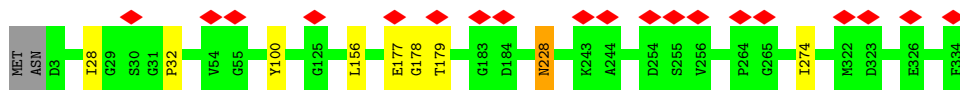

• Molecule 3: Baseplate wedge protein gp8



• Molecule 3: Baseplate wedge protein gp8

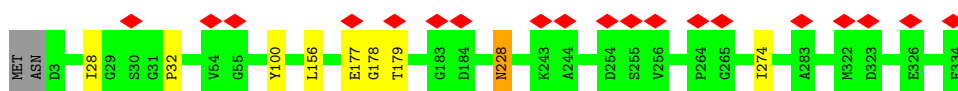

- Molecule 3: Baseplate wedge protein gp8



- Molecule 3: Baseplate wedge protein gp8

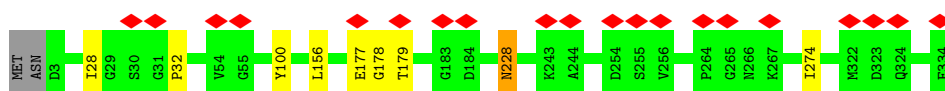

- Molecule 3: Baseplate wedge protein gp8

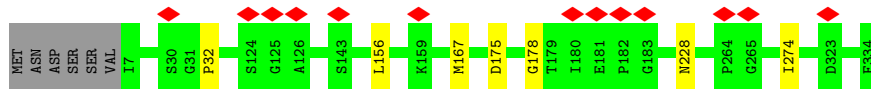

- Molecule 3: Baseplate wedge protein gp8

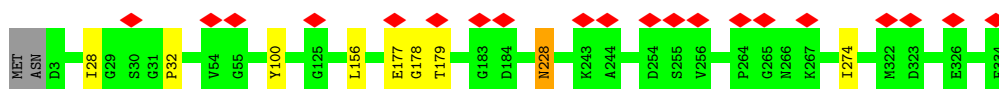

- Molecule 3: Baseplate wedge protein gp8

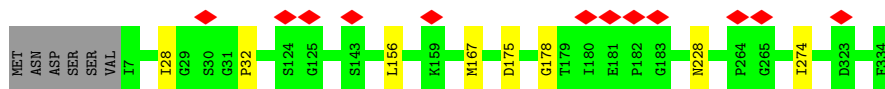

- Molecule 3: Baseplate wedge protein gp8

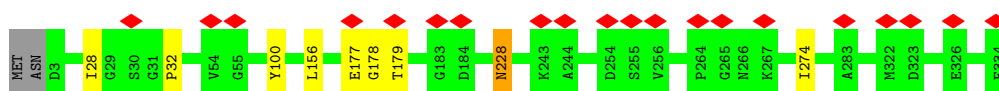

• Molecule 4: Baseplate wedge protein gp9

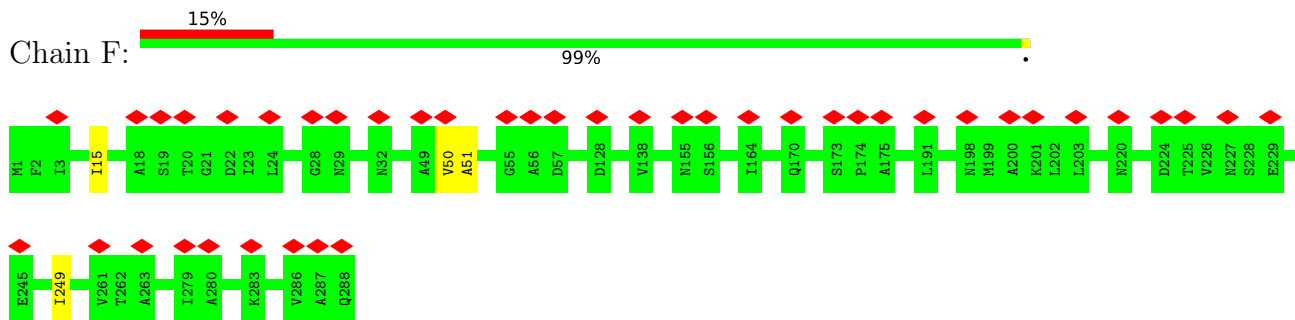

• Molecule 4: Baseplate wedge protein gp9

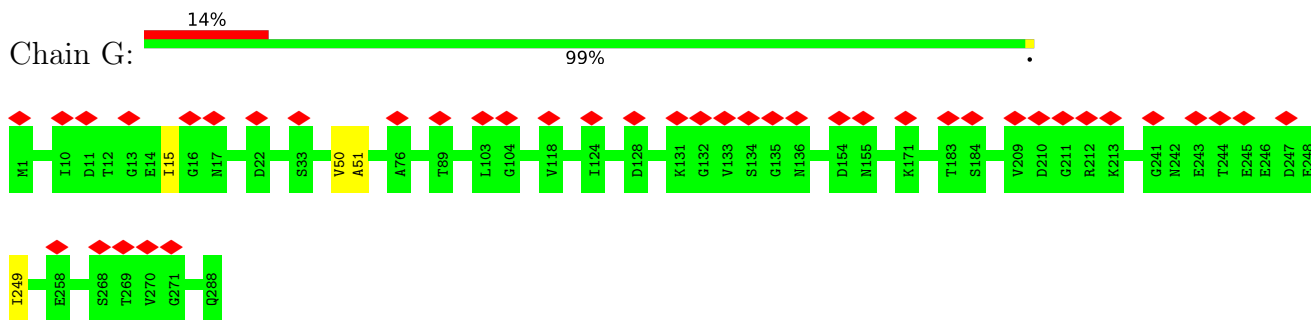

• Molecule 4: Baseplate wedge protein gp9

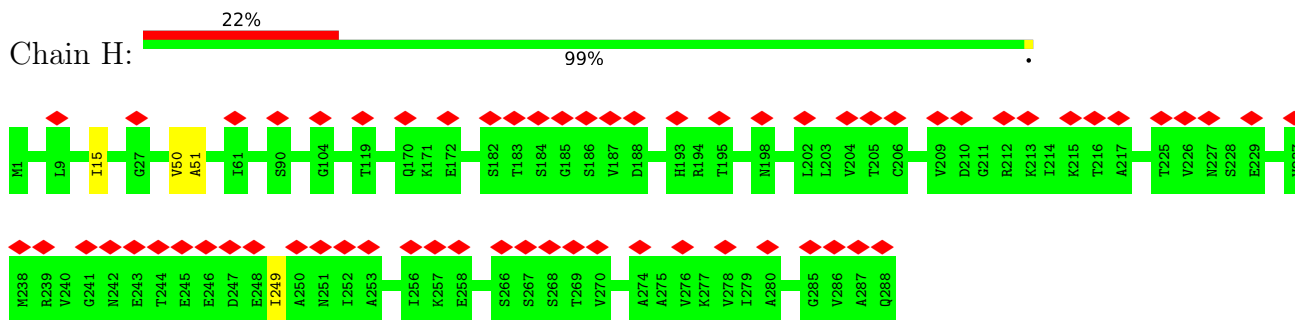

• Molecule 4: Baseplate wedge protein gp9

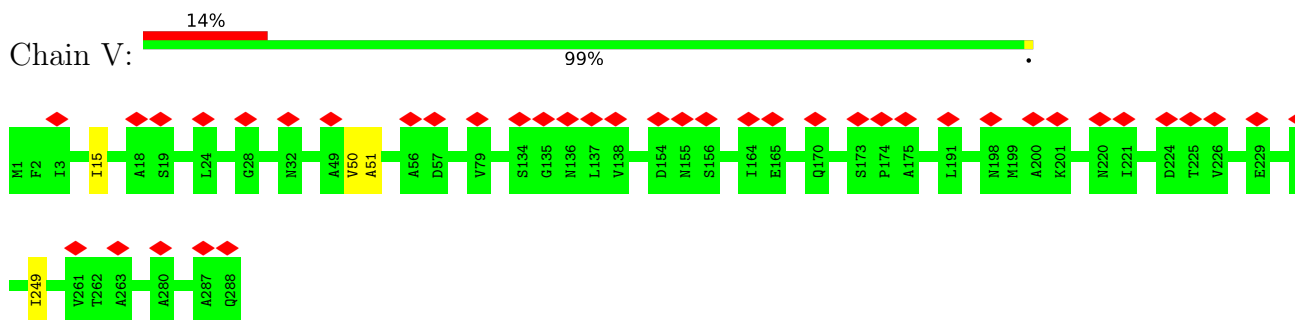

• Molecule 4: Baseplate wedge protein gp9



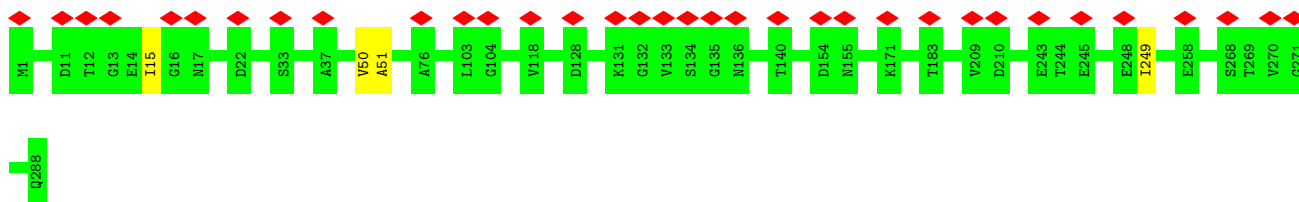

• Molecule 4: Baseplate wedge protein gp9

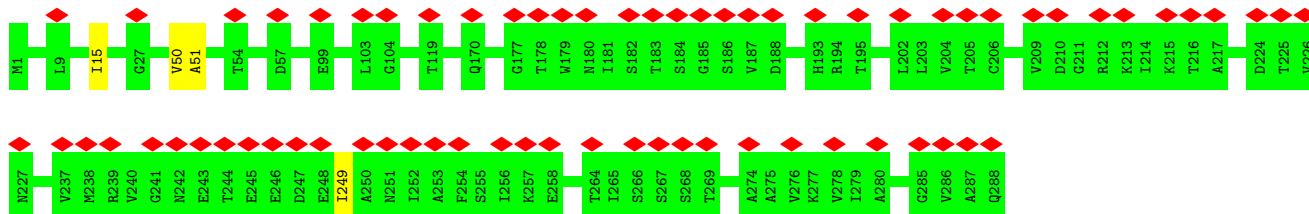

• Molecule 4: Baseplate wedge protein gp9

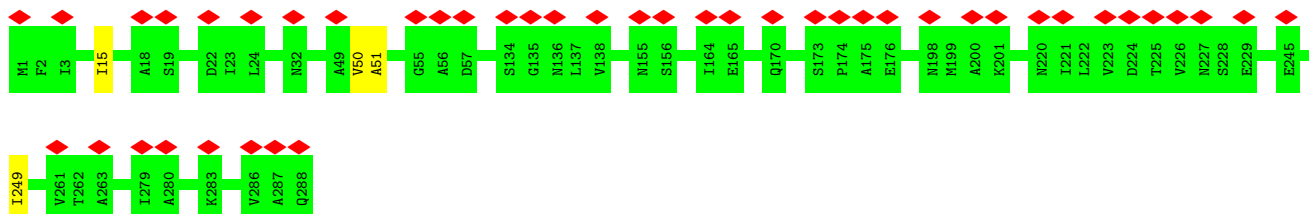

• Molecule 4: Baseplate wedge protein gp9

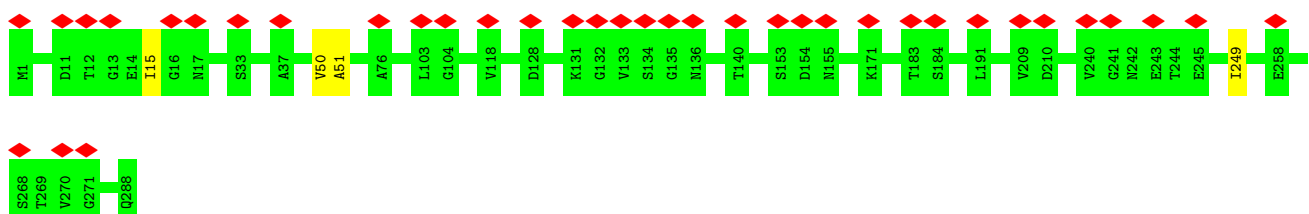

• Molecule 4: Baseplate wedge protein gp9

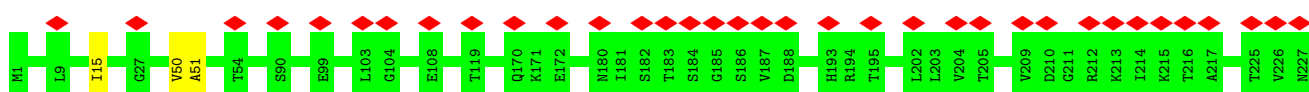

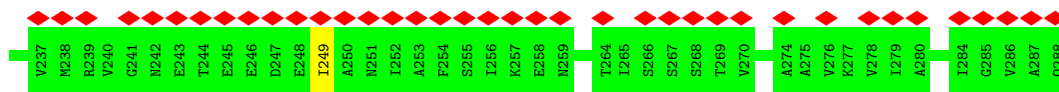

• Molecule 4: Baseplate wedge protein gp9

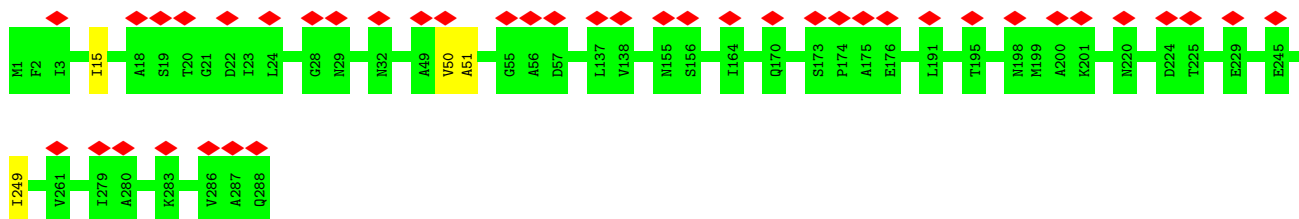

• Molecule 4: Baseplate wedge protein gp9

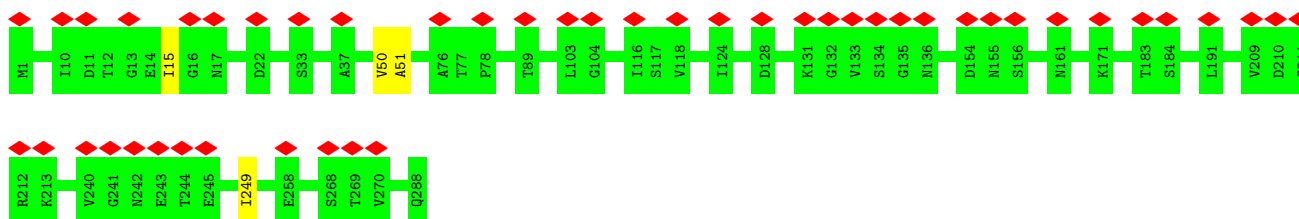

• Molecule 4: Baseplate wedge protein gp9

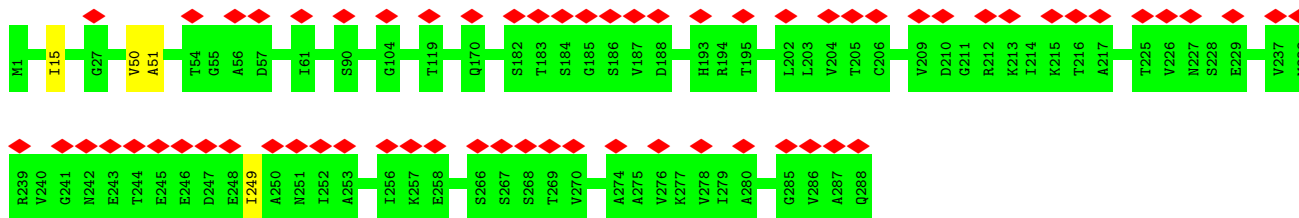

• Molecule 4: Baseplate wedge protein gp9

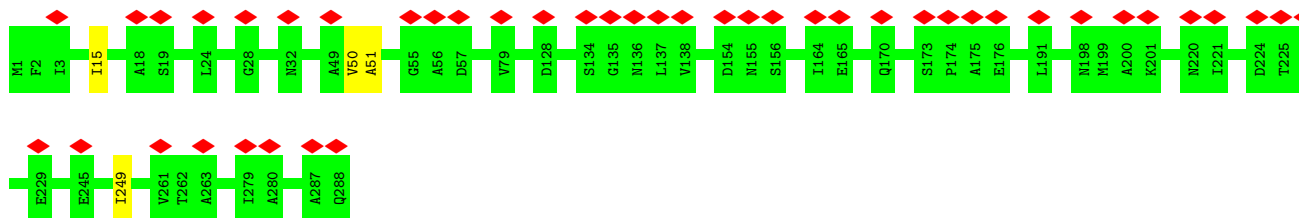

• Molecule 4: Baseplate wedge protein gp9

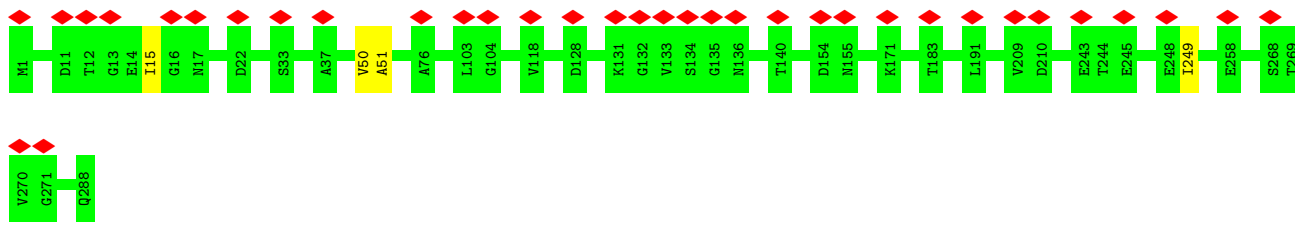

• Molecule 4: Baseplate wedge protein gp9

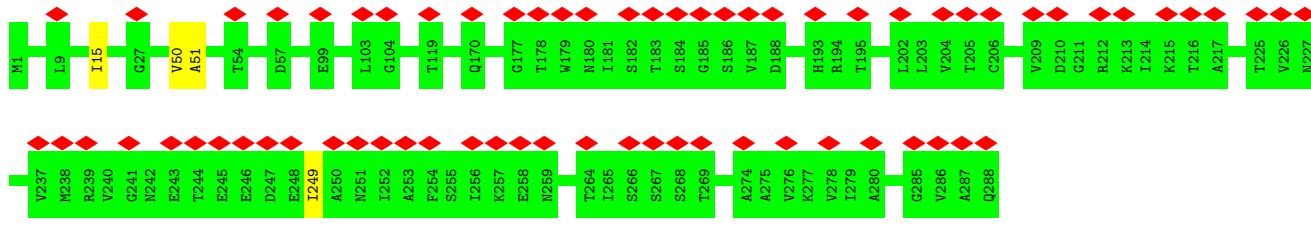

• Molecule 4: Baseplate wedge protein gp9

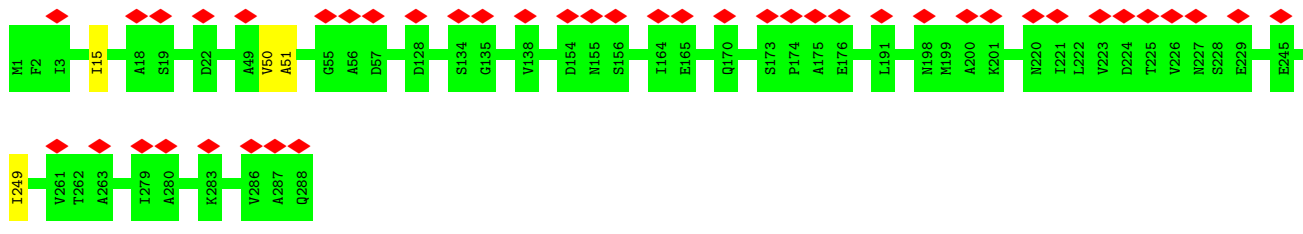

• Molecule 4: Baseplate wedge protein gp9

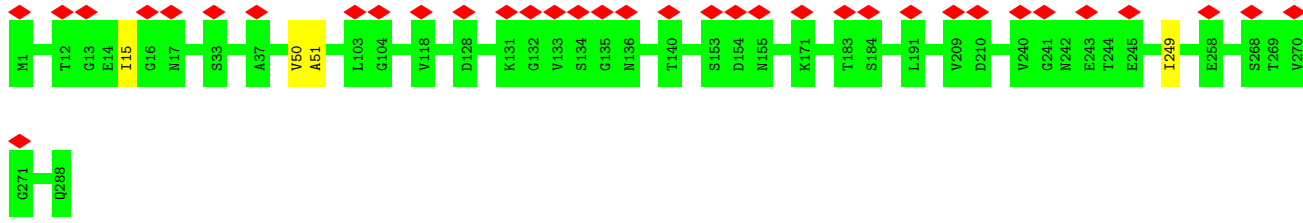

• Molecule 4: Baseplate wedge protein gp9

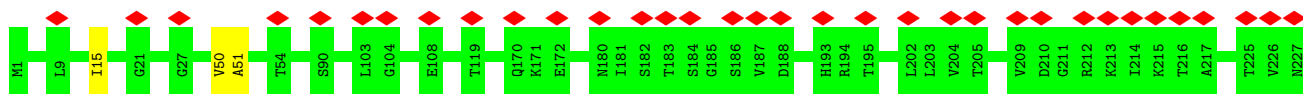

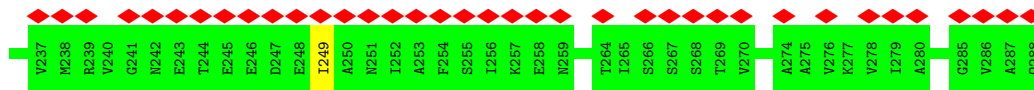

• Molecule 5: Baseplate wedge protein gp10

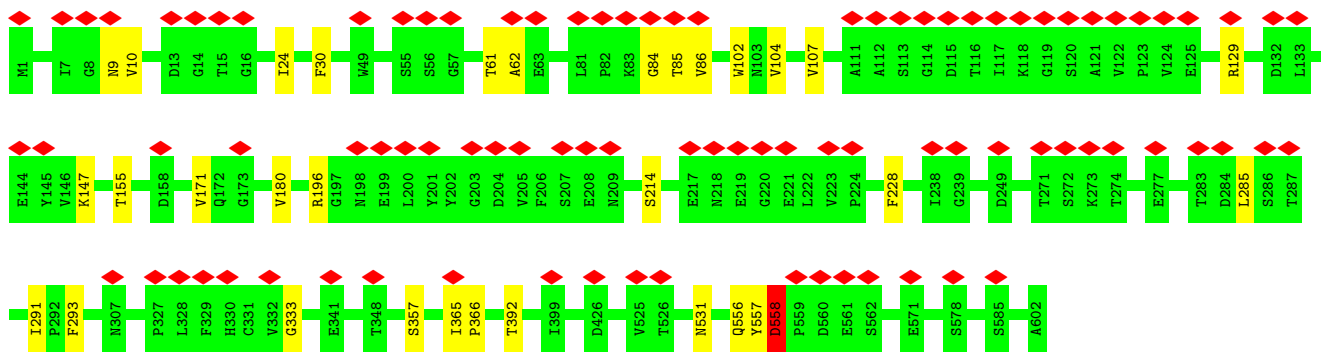

• Molecule 5: Baseplate wedge protein gp10

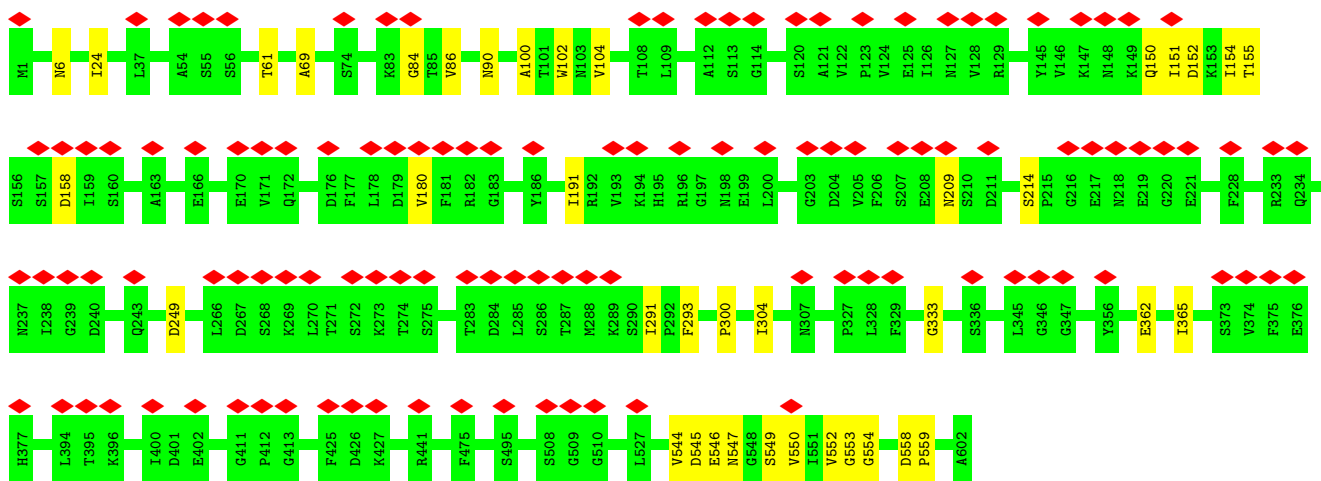
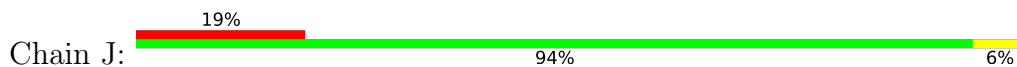

• Molecule 5: Baseplate wedge protein gp10

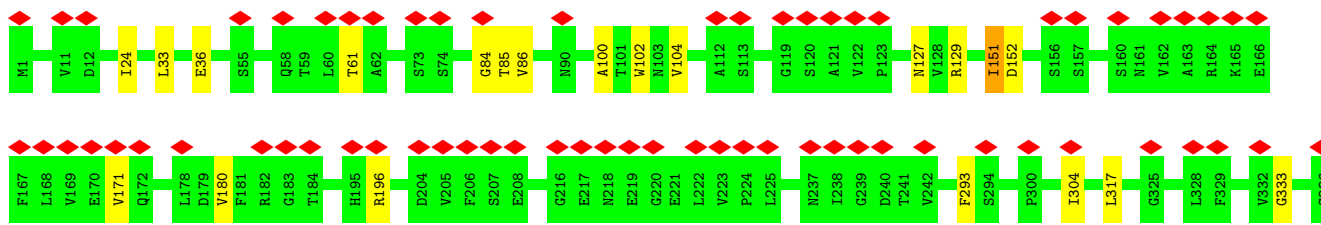





• Molecule 5: Baseplate wedge protein gp10

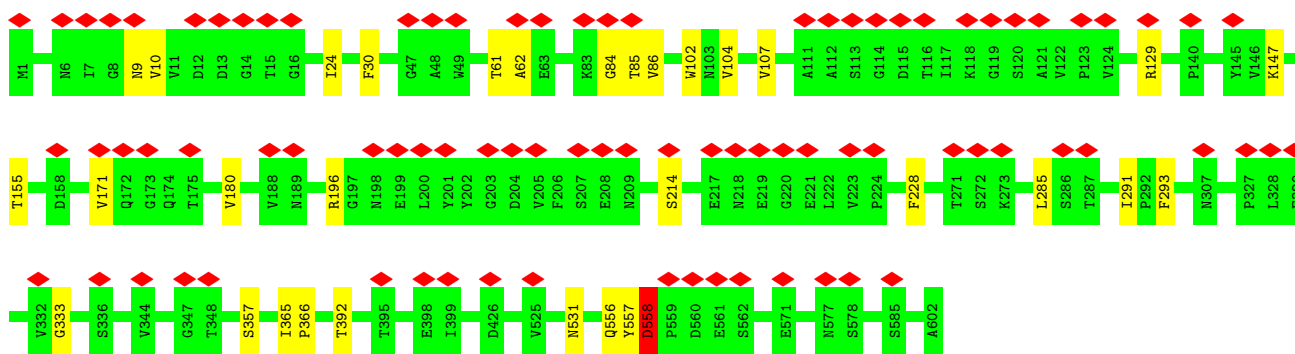

• Molecule 5: Baseplate wedge protein gp10

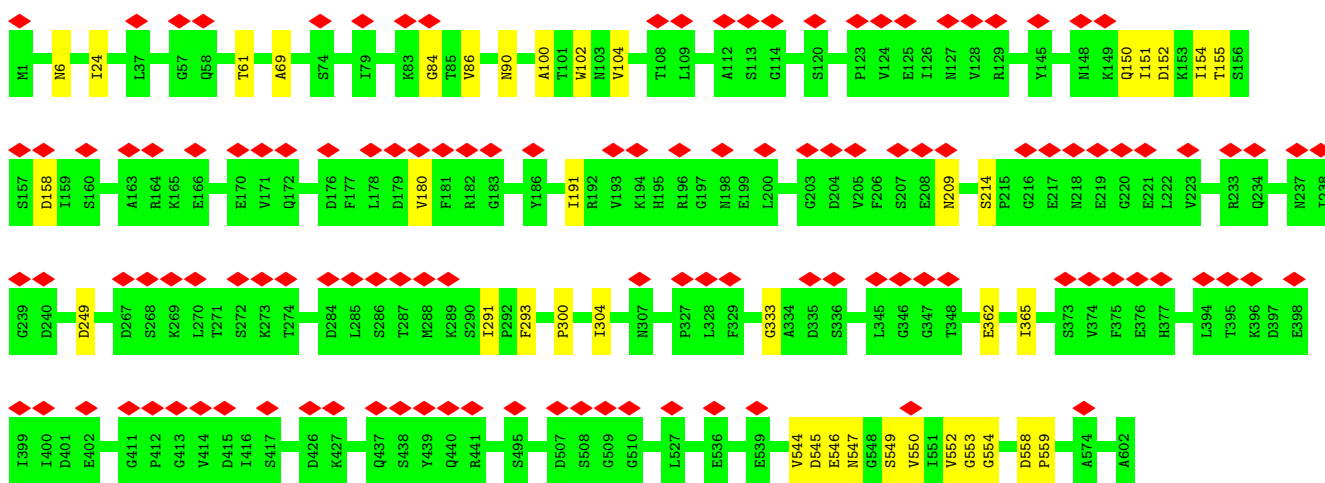
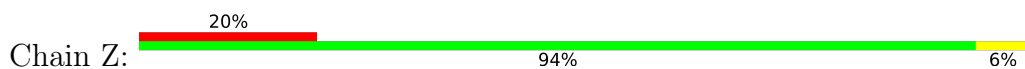

• Molecule 5: Baseplate wedge protein gp10

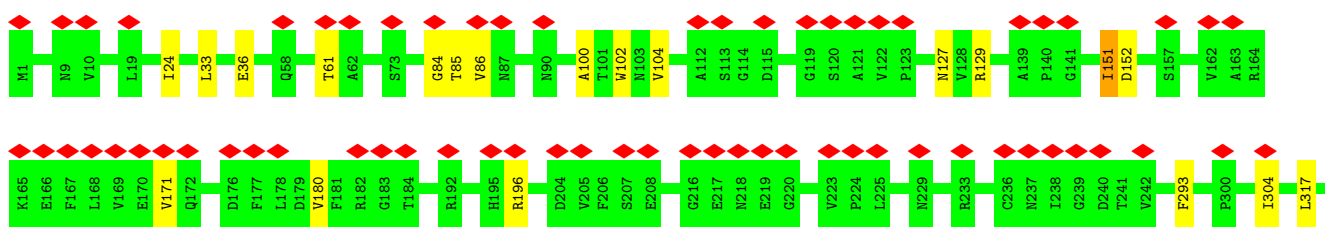

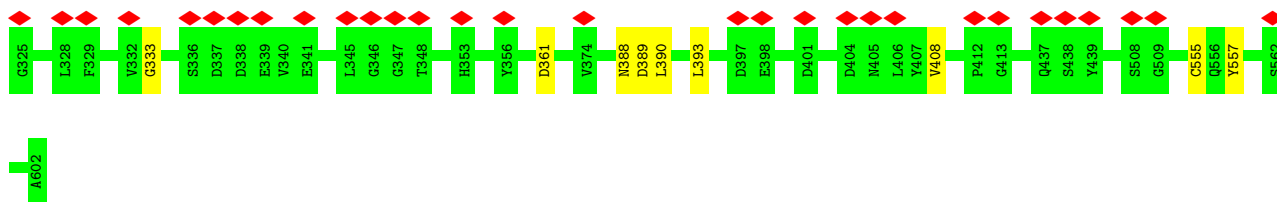

• Molecule 5: Baseplate wedge protein gp10

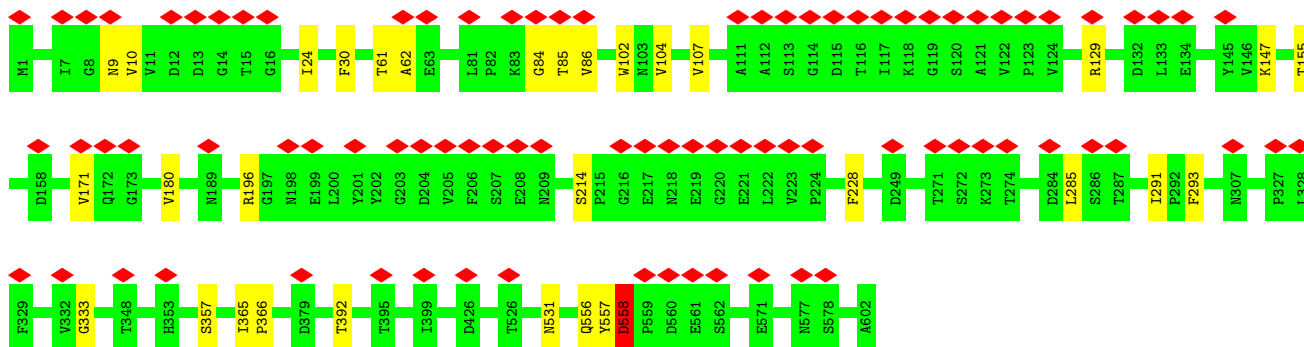

• Molecule 5: Baseplate wedge protein gp10

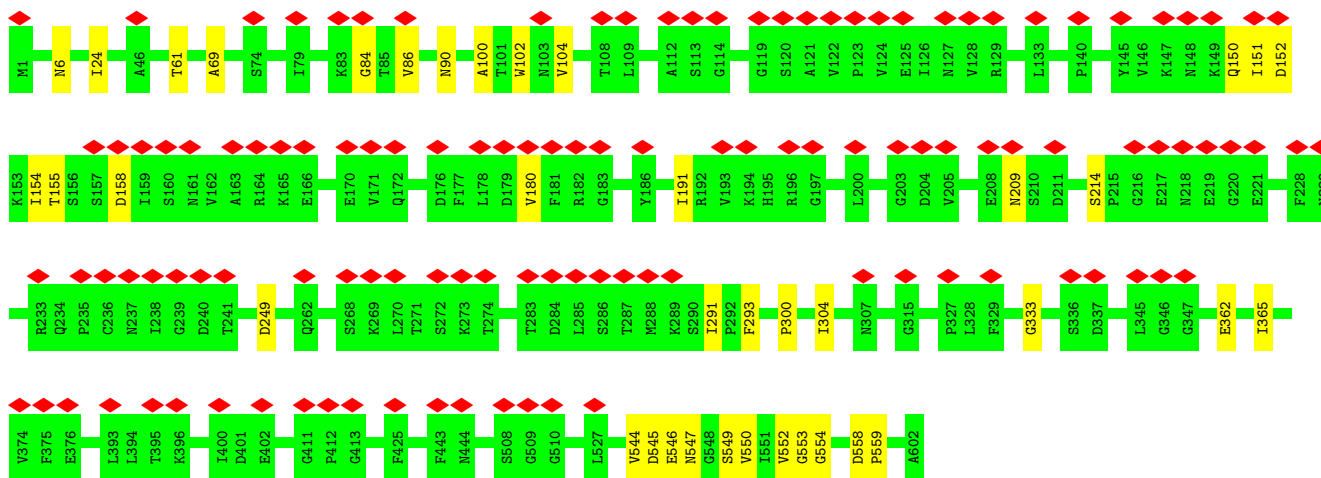

• Molecule 5: Baseplate wedge protein gp10

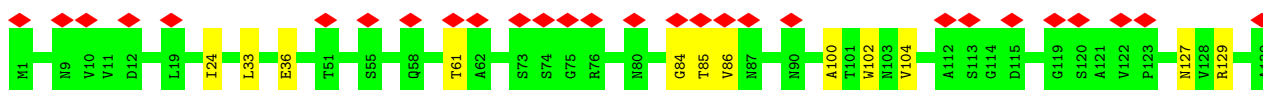

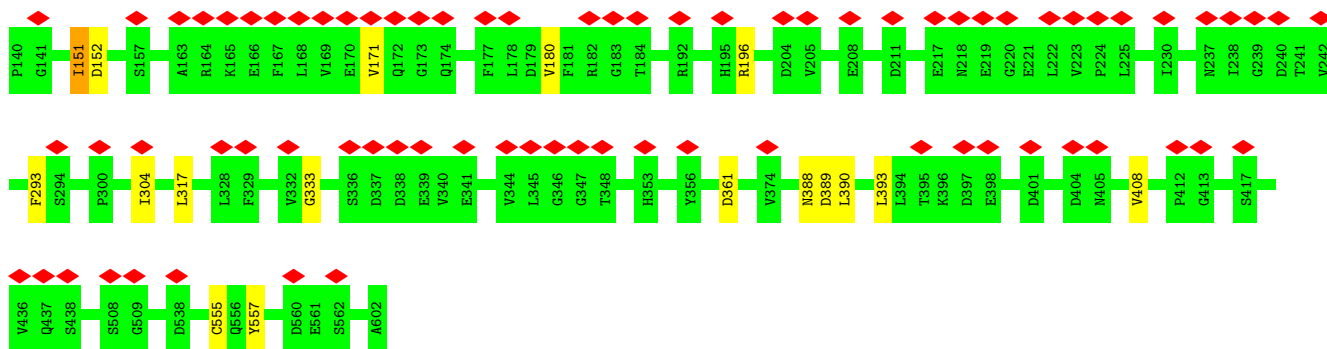

• Molecule 5: Baseplate wedge protein gp10

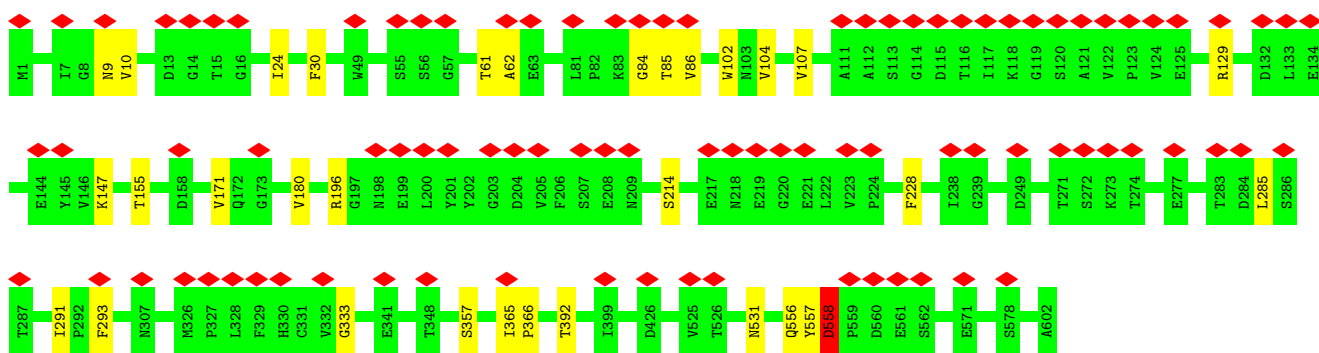

• Molecule 5: Baseplate wedge protein gp10

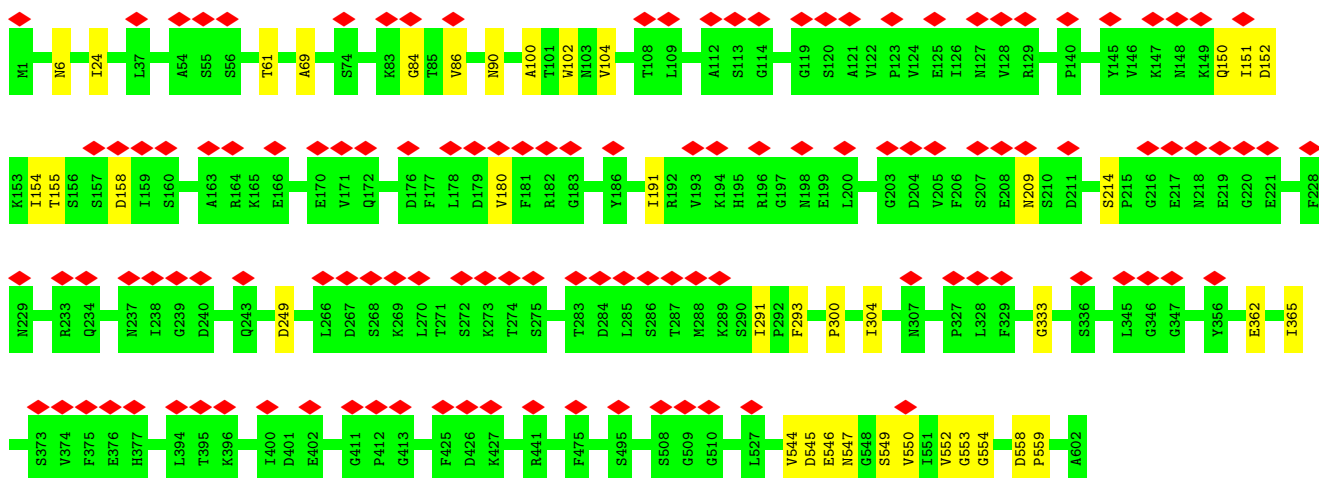

• Molecule 5: Baseplate wedge protein gp10



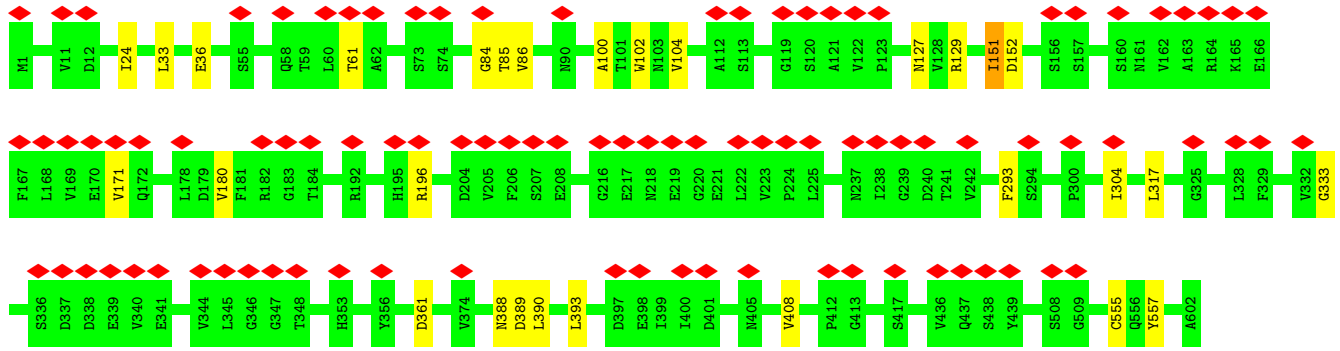

• Molecule 5: Baseplate wedge protein gp10

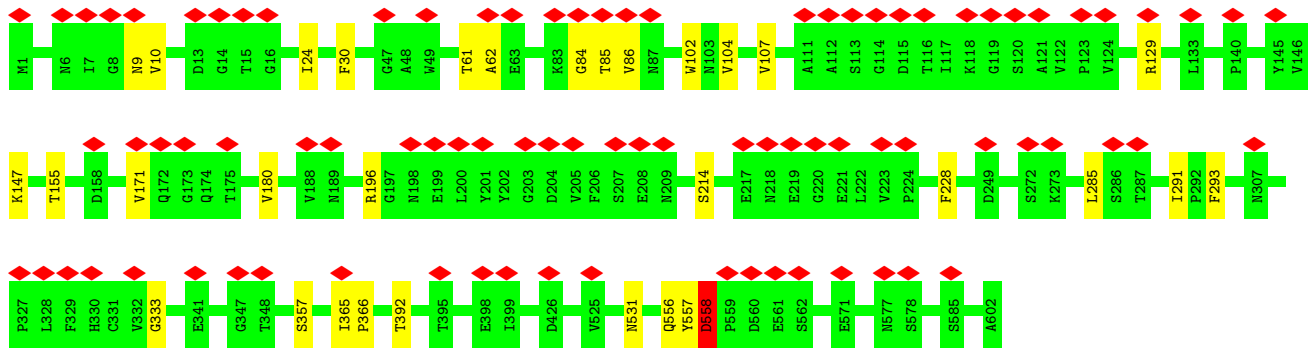

• Molecule 5: Baseplate wedge protein gp10

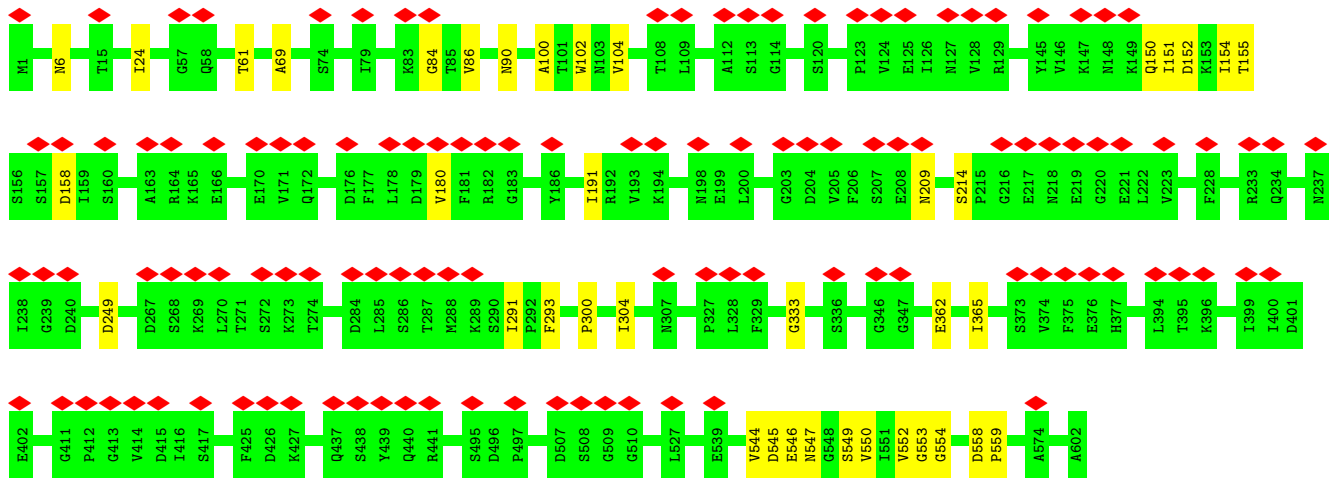

• Molecule 5: Baseplate wedge protein gp10



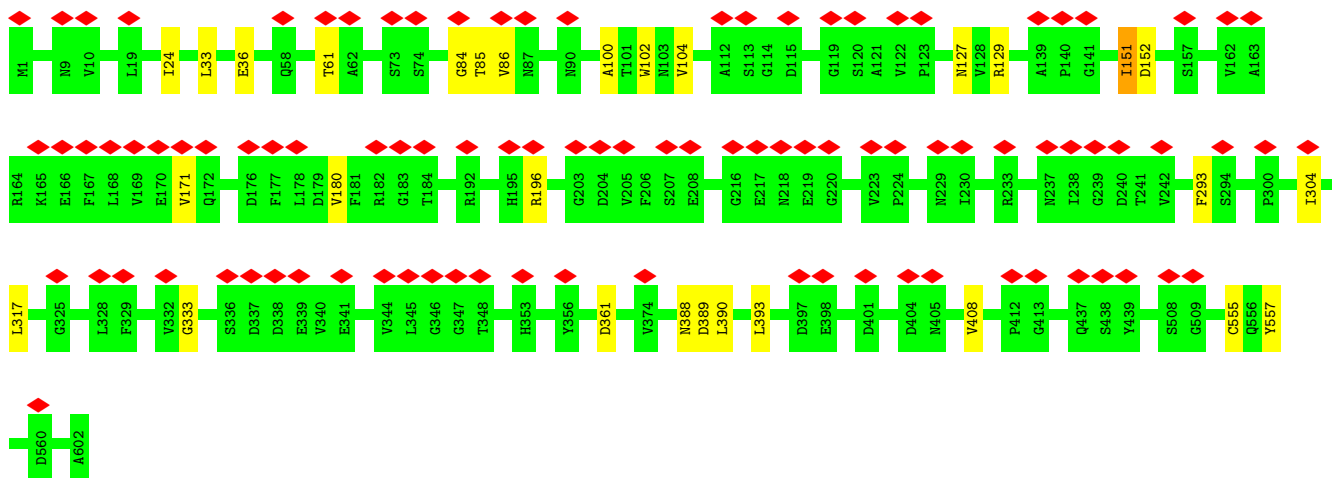

• Molecule 5: Baseplate wedge protein gp10

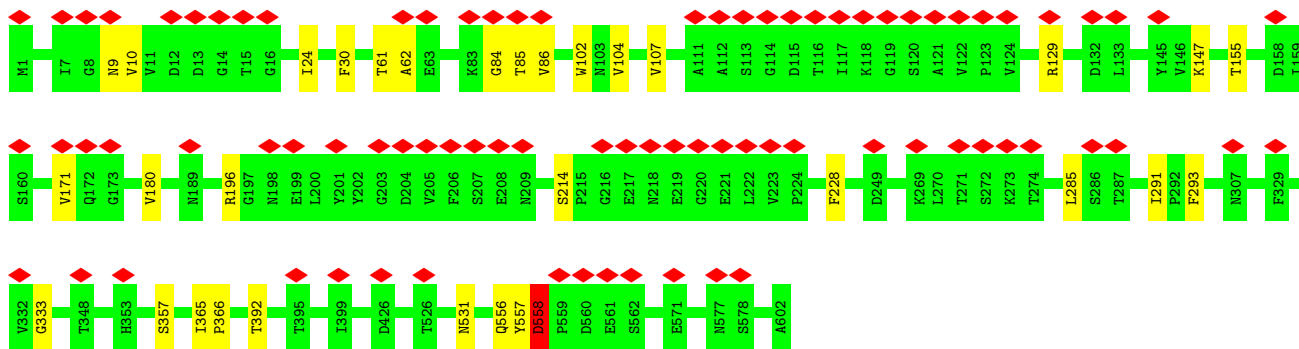

• Molecule 5: Baseplate wedge protein gp10

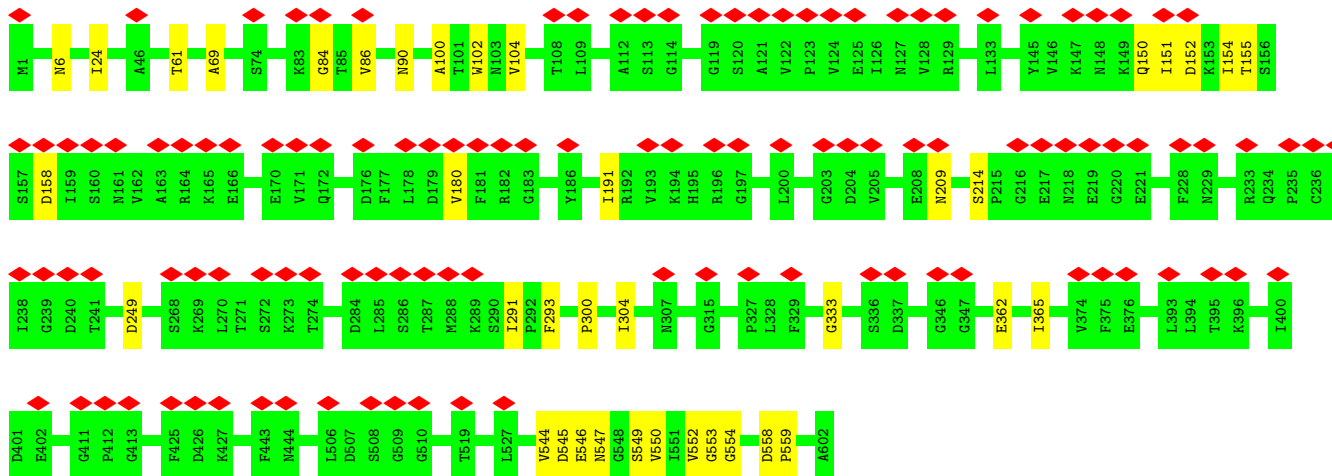

• Molecule 5: Baseplate wedge protein gp10

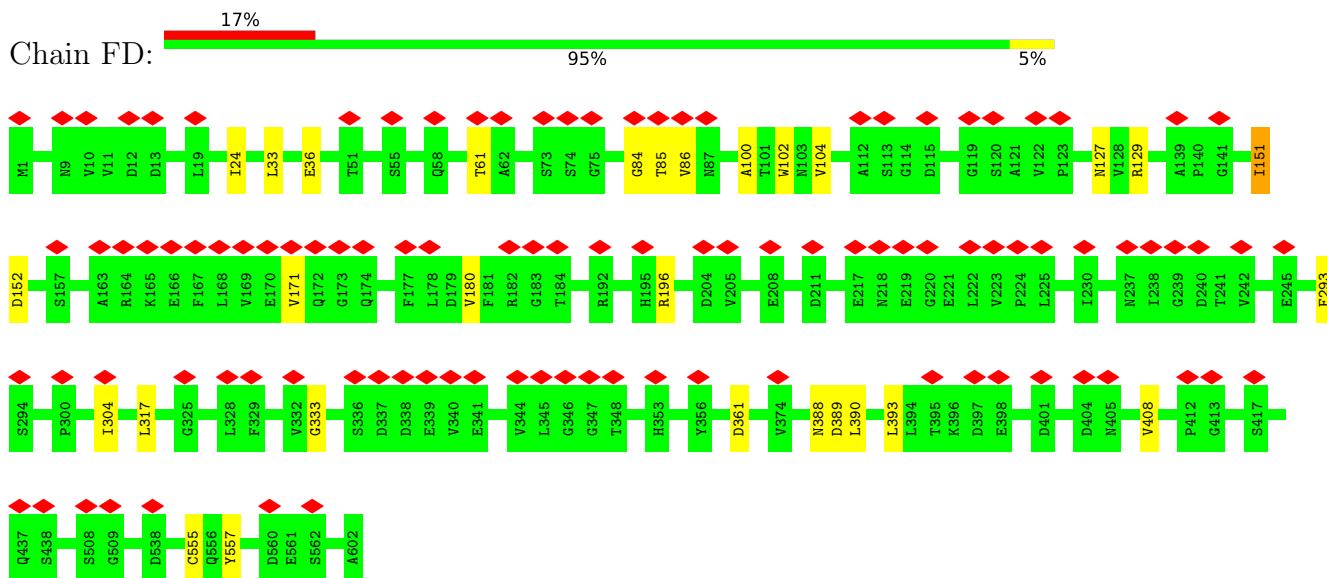

• Molecule 6: Baseplate wedge protein gp11

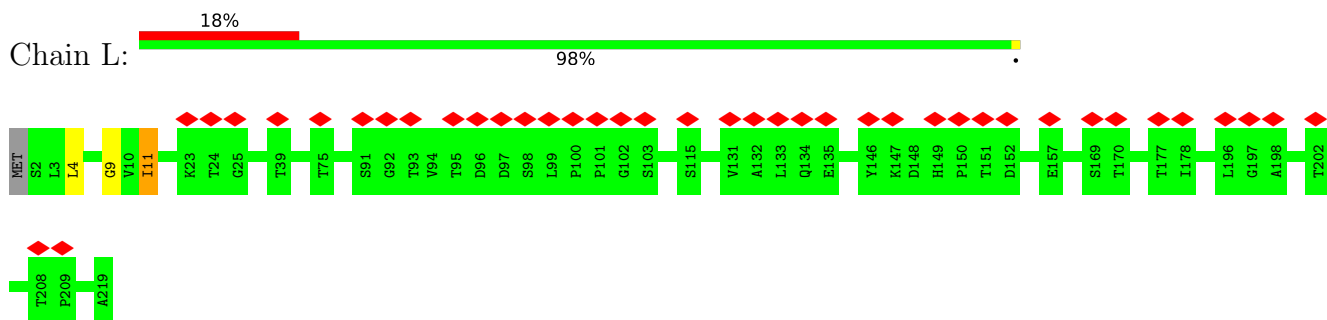

• Molecule 6: Baseplate wedge protein gp11

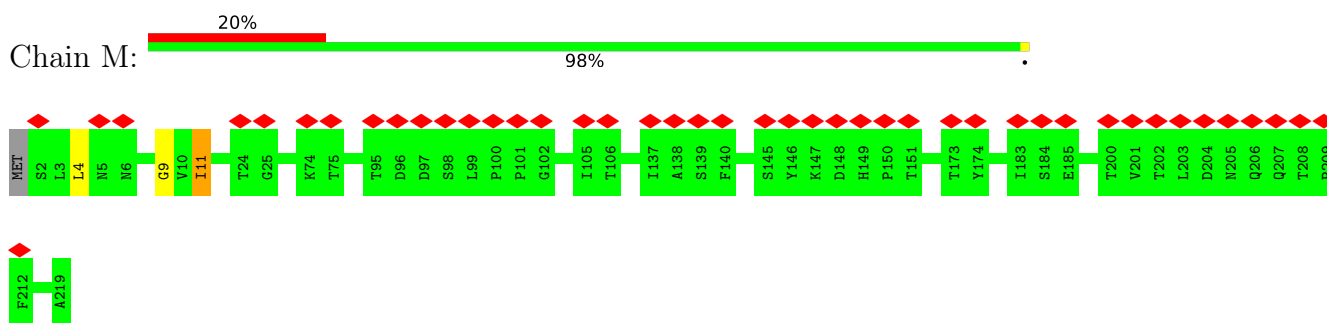

• Molecule 6: Baseplate wedge protein gp11

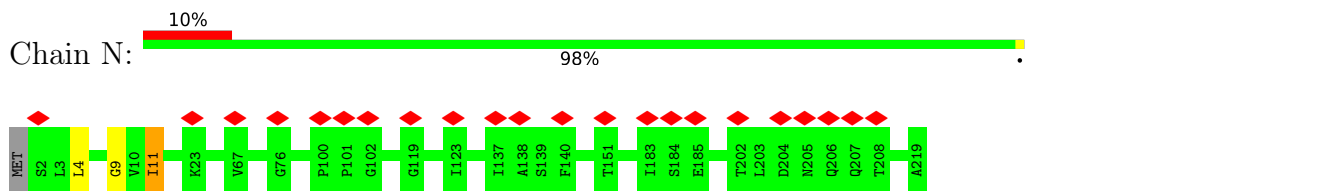

• Molecule 6: Baseplate wedge protein gp11



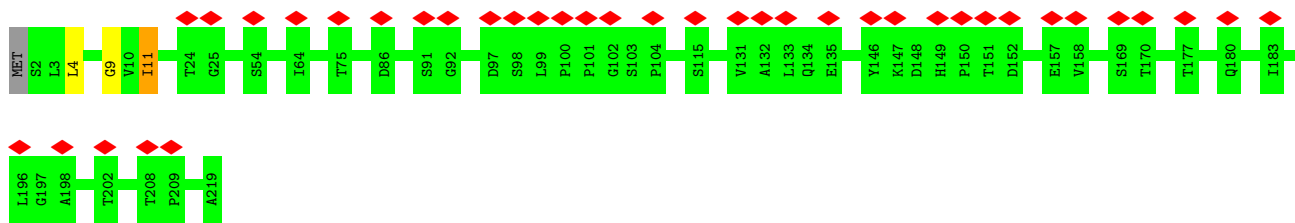

• Molecule 6: Baseplate wedge protein gp11

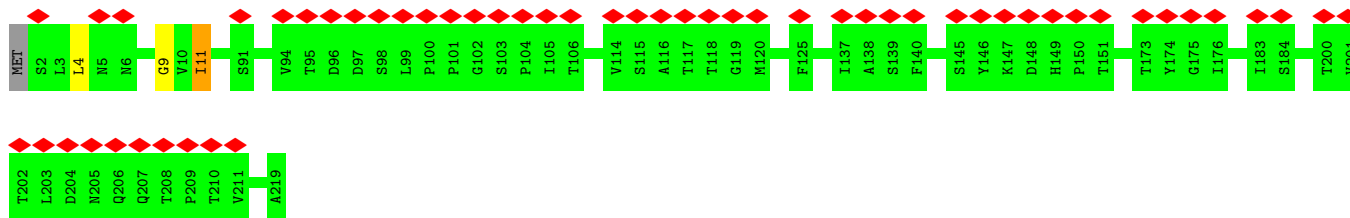

• Molecule 6: Baseplate wedge protein gp11

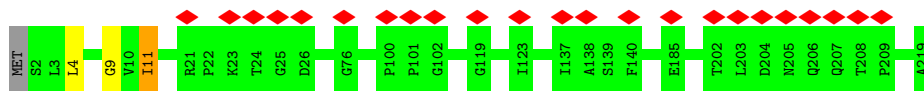

• Molecule 6: Baseplate wedge protein gp11

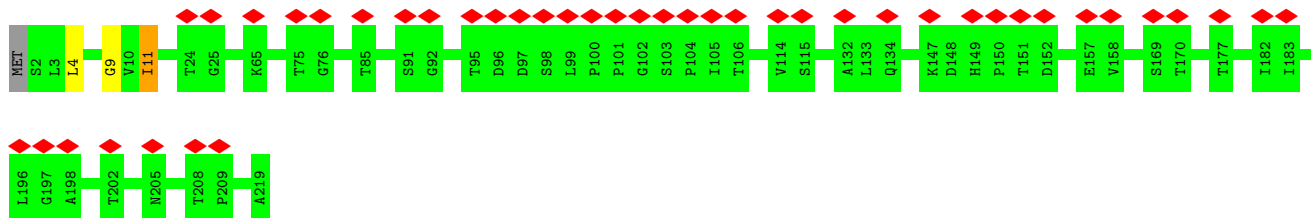

• Molecule 6: Baseplate wedge protein gp11

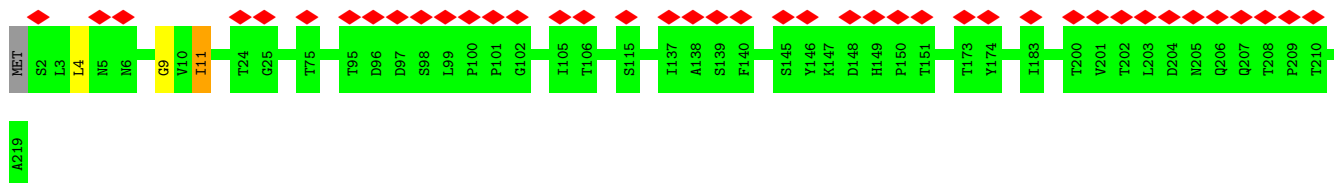

• Molecule 6: Baseplate wedge protein gp11

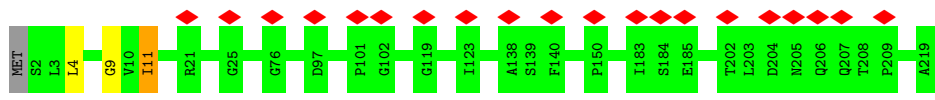

• Molecule 6: Baseplate wedge protein gp11

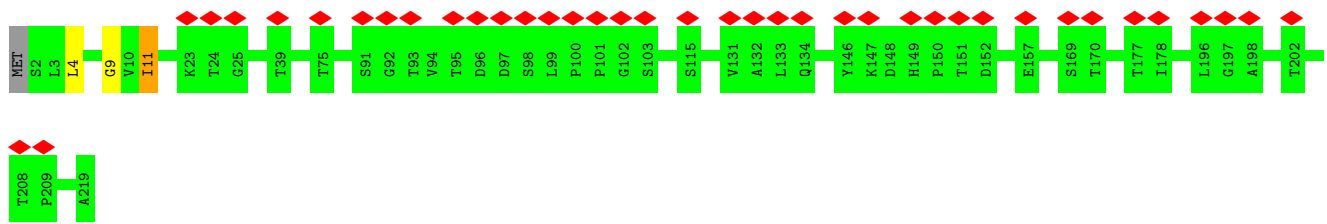

• Molecule 6: Baseplate wedge protein gp11

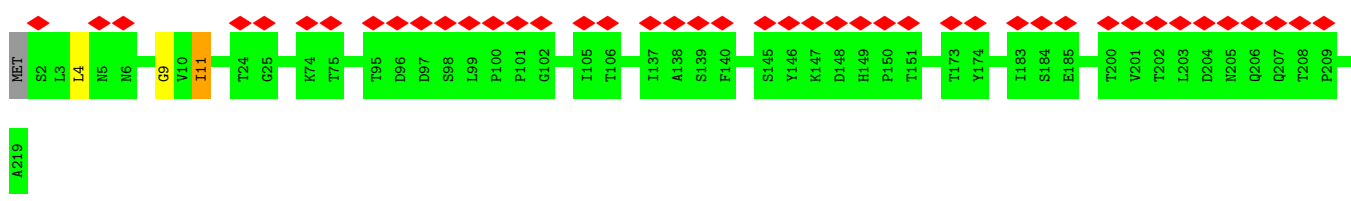

• Molecule 6: Baseplate wedge protein gp11

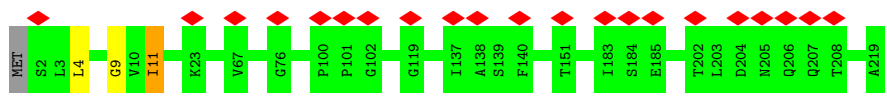

• Molecule 6: Baseplate wedge protein gp11

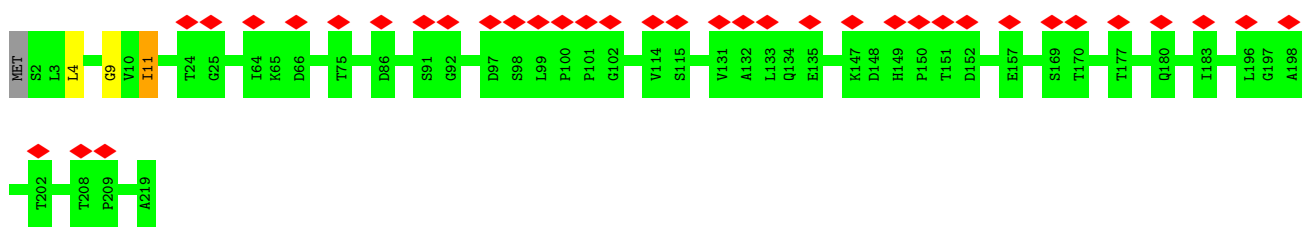

• Molecule 6: Baseplate wedge protein gp11





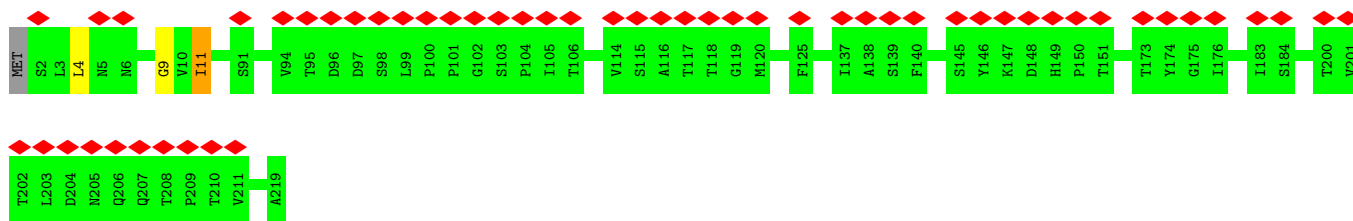

• Molecule 6: Baseplate wedge protein gp11

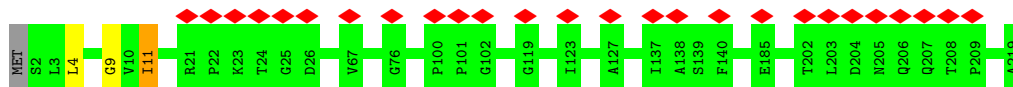

• Molecule 6: Baseplate wedge protein gp11

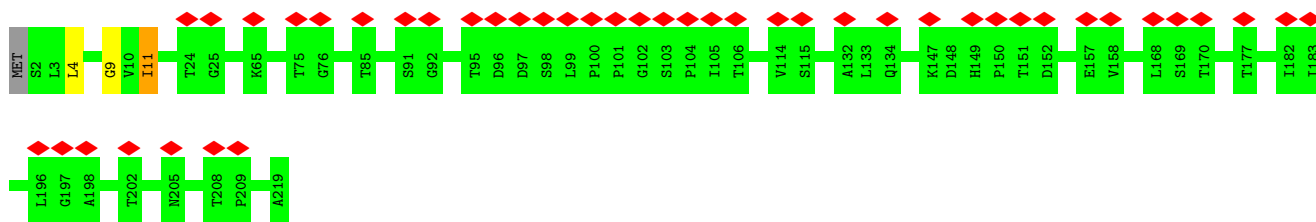

• Molecule 6: Baseplate wedge protein gp11

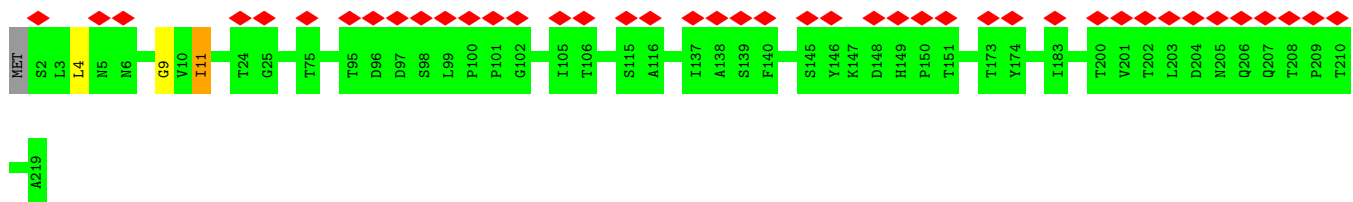

• Molecule 6: Baseplate wedge protein gp11

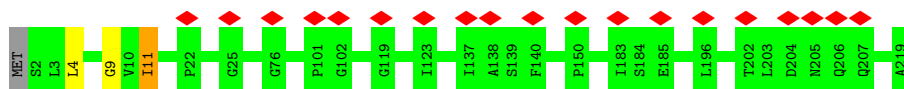

• Molecule 7: Baseplate wedge protein gp25



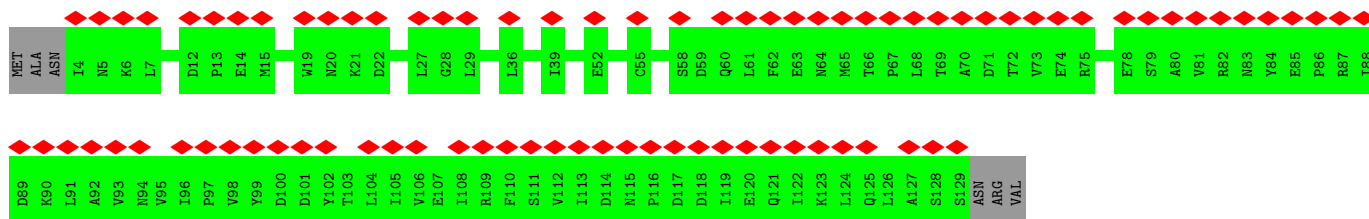

• Molecule 7: Baseplate wedge protein gp25



Chain e:

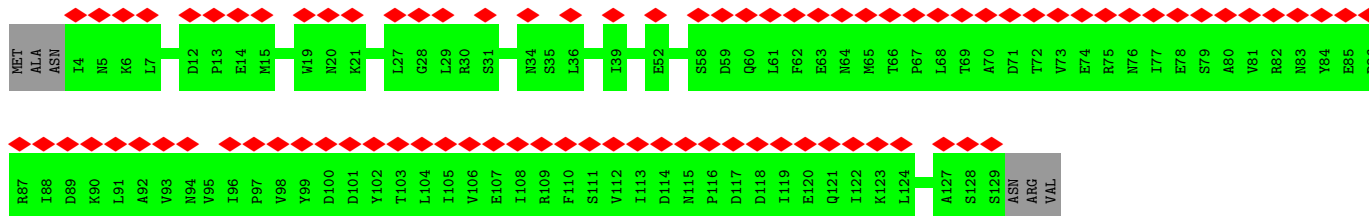

• Molecule 7: Baseplate wedge protein gp25



Chain u:

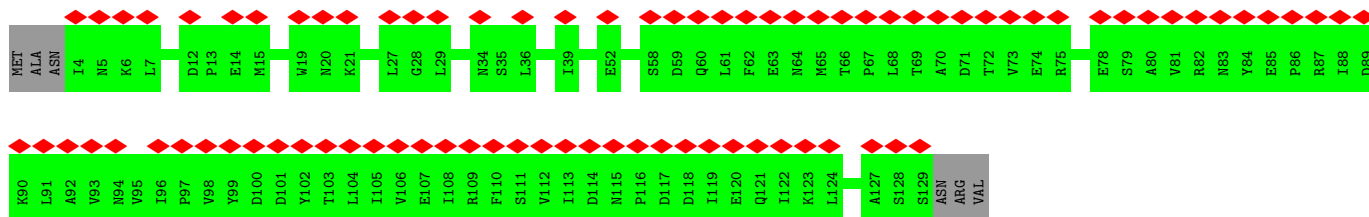

• Molecule 7: Baseplate wedge protein gp25



Chain BD:

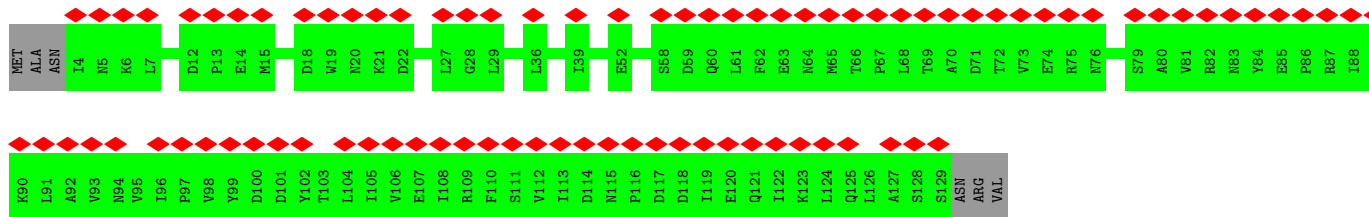

• Molecule 7: Baseplate wedge protein gp25



Chain DF:

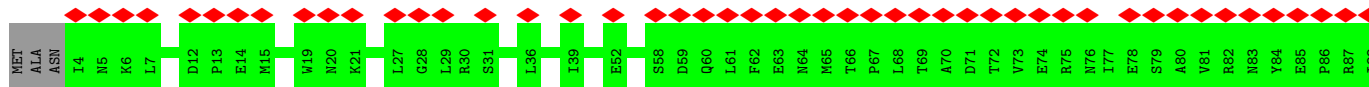

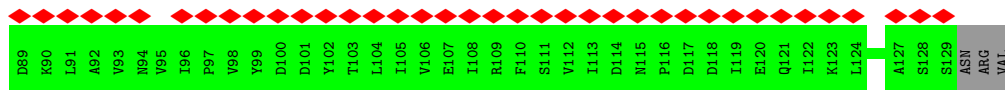

• Molecule 7: Baseplate wedge protein gp25

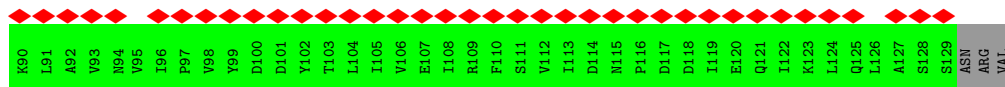
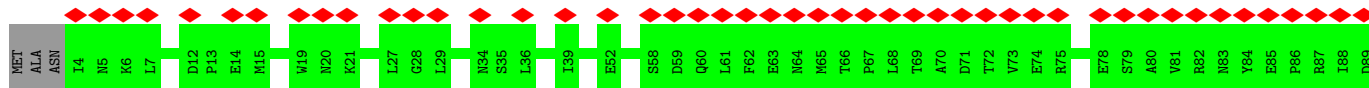

• Molecule 8: Baseplate wedge protein gp53

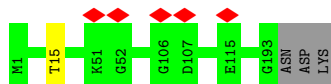

• Molecule 8: Baseplate wedge protein gp53

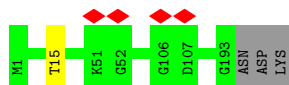

• Molecule 8: Baseplate wedge protein gp53

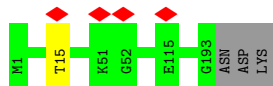

• Molecule 8: Baseplate wedge protein gp53

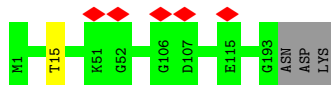

• Molecule 8: Baseplate wedge protein gp53



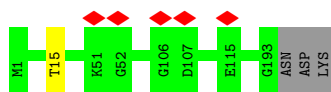

- Molecule 8: Baseplate wedge protein gp53

Chain GB: 98% ..

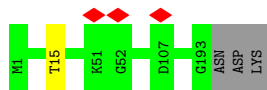

## 4 Experimental information

Property	Value	Source
EM reconstruction method	SINGLE PARTICLE	Depositor
Imposed symmetry	POINT, C6	Depositor
Number of particles used	5176	Depositor
Resolution determination method	FSC 0.143 CUT-OFF	Depositor
CTF correction method	PHASE FLIPPING AND AMPLITUDE CORRECTION	Depositor
Microscope	FEI TITAN KRIOS	Depositor
Voltage (kV)	300	Depositor
Electron dose ( $e^-/\text{\AA}^2$ )	60	Depositor
Minimum defocus (nm)	500	Depositor
Maximum defocus (nm)	4000	Depositor
Magnification	37700	Depositor
Image detector	GATAN K2 SUMMIT (4k x 4k)	Depositor
Maximum map value	0.037	Depositor
Minimum map value	-0.009	Depositor
Average map value	0.000	Depositor
Map value standard deviation	0.002	Depositor
Recommended contour level	0.0095	Depositor
Map size (Å)	636.48, 636.48, 636.48	wwPDB
Map dimensions	480, 480, 480	wwPDB
Map angles (°)	90.0, 90.0, 90.0	wwPDB
Pixel spacing (Å)	1.326, 1.326, 1.326	Depositor

## 5 Model quality i

### 5.1 Standard geometry i

The Z score for a bond length (or angle) is the number of standard deviations the observed value is removed from the expected value. A bond length (or angle) with  $|Z| > 5$  is considered an outlier worth inspection. RMSZ is the root-mean-square of all Z scores of the bond lengths (or angles).

Mol	Chain	Bond lengths		Bond angles	
		RMSZ	# Z  >5	RMSZ	# Z  >5
1	A	0.45	0/5337	0.63	1/7256 (0.0%)
1	B	0.47	0/5257	0.65	0/7144
1	BF	0.45	0/5337	0.63	1/7256 (0.0%)
1	BG	0.47	0/5257	0.65	0/7144
1	EA	0.45	0/5337	0.63	1/7256 (0.0%)
1	EB	0.47	0/5257	0.65	0/7144
1	Q	0.45	0/5337	0.63	1/7256 (0.0%)
1	R	0.47	0/5257	0.65	0/7144
1	g	0.45	0/5337	0.63	1/7256 (0.0%)
1	h	0.47	0/5257	0.65	0/7144
1	w	0.45	0/5337	0.63	1/7256 (0.0%)
1	x	0.47	0/5257	0.65	0/7144
2	C	0.51	3/8405 (0.0%)	0.75	7/11412 (0.1%)
2	CA	0.51	3/8405 (0.0%)	0.75	7/11412 (0.1%)
2	EC	0.51	3/8405 (0.0%)	0.75	7/11412 (0.1%)
2	S	0.51	3/8405 (0.0%)	0.75	7/11412 (0.1%)
2	i	0.51	3/8405 (0.0%)	0.75	7/11412 (0.1%)
2	y	0.51	3/8405 (0.0%)	0.75	7/11412 (0.1%)
3	AA	0.56	0/2736	0.79	3/3731 (0.1%)
3	CB	0.56	0/2709	0.79	3/3694 (0.1%)
3	CC	0.56	0/2736	0.79	3/3731 (0.1%)
3	D	0.56	0/2709	0.79	3/3694 (0.1%)
3	E	0.56	0/2736	0.79	3/3731 (0.1%)
3	ED	0.56	0/2709	0.79	3/3694 (0.1%)
3	EE	0.56	0/2736	0.79	3/3731 (0.1%)
3	T	0.56	0/2709	0.79	3/3694 (0.1%)
3	U	0.56	0/2736	0.79	3/3731 (0.1%)
3	j	0.56	0/2709	0.79	3/3694 (0.1%)
3	k	0.56	0/2736	0.79	3/3731 (0.1%)
3	z	0.56	0/2709	0.80	3/3694 (0.1%)
4	AB	0.40	0/2205	0.58	0/2988
4	AC	0.40	0/2205	0.58	0/2988
4	AD	0.40	0/2205	0.58	0/2988
4	CD	0.40	0/2205	0.58	0/2988

Mol	Chain	Bond lengths		Bond angles	
		RMSZ	# Z  >5	RMSZ	# Z  >5
4	CE	0.40	0/2205	0.58	0/2988
4	CF	0.40	0/2205	0.58	0/2988
4	EF	0.40	0/2205	0.58	0/2988
4	EG	0.40	0/2205	0.58	0/2988
4	F	0.40	0/2205	0.58	0/2988
4	FA	0.40	0/2205	0.58	0/2988
4	G	0.40	0/2205	0.58	0/2988
4	H	0.40	0/2205	0.58	0/2988
4	V	0.40	0/2205	0.58	0/2988
4	W	0.40	0/2205	0.58	0/2988
4	X	0.40	0/2205	0.58	0/2988
4	l	0.40	0/2205	0.58	0/2988
4	m	0.40	0/2205	0.58	0/2988
4	n	0.40	0/2205	0.58	0/2988
5	AE	0.42	0/4777	0.68	4/6510 (0.1%)
5	AF	0.43	0/4778	0.71	3/6513 (0.0%)
5	AG	0.44	0/4778	0.69	3/6513 (0.0%)
5	CG	0.42	0/4777	0.68	4/6510 (0.1%)
5	DA	0.43	0/4778	0.71	3/6513 (0.0%)
5	DB	0.44	0/4778	0.69	3/6513 (0.0%)
5	FB	0.42	0/4777	0.68	4/6510 (0.1%)
5	FC	0.43	0/4778	0.71	3/6513 (0.0%)
5	FD	0.44	0/4778	0.69	3/6513 (0.0%)
5	I	0.42	0/4777	0.68	4/6510 (0.1%)
5	J	0.43	0/4778	0.71	3/6513 (0.0%)
5	K	0.44	0/4778	0.69	3/6513 (0.0%)
5	Y	0.42	0/4777	0.68	4/6510 (0.1%)
5	Z	0.43	0/4778	0.71	3/6513 (0.0%)
5	a	0.44	0/4778	0.69	3/6513 (0.0%)
5	o	0.42	0/4777	0.68	4/6510 (0.1%)
5	p	0.43	0/4778	0.71	3/6513 (0.0%)
5	q	0.44	0/4778	0.69	3/6513 (0.0%)
6	BA	0.42	0/1700	0.62	0/2318
6	BB	0.42	0/1700	0.62	0/2318
6	BC	0.42	0/1700	0.63	0/2318
6	DC	0.42	0/1700	0.62	0/2318
6	DD	0.42	0/1700	0.62	0/2318
6	DE	0.42	0/1700	0.62	0/2318
6	FE	0.42	0/1700	0.62	0/2318
6	FF	0.42	0/1700	0.62	0/2318
6	FG	0.42	0/1700	0.62	0/2318
6	L	0.42	0/1700	0.62	0/2318
6	M	0.42	0/1700	0.62	0/2318

Mol	Chain	Bond lengths		Bond angles	
		RMSZ	# Z  >5	RMSZ	# Z  >5
6	N	0.42	0/1700	0.62	0/2318
6	b	0.42	0/1700	0.62	0/2318
6	c	0.42	0/1700	0.62	0/2318
6	d	0.42	0/1700	0.63	0/2318
6	r	0.42	0/1700	0.62	0/2318
6	s	0.42	0/1700	0.62	0/2318
6	t	0.42	0/1700	0.62	0/2318
7	BD	0.35	0/1027	0.58	0/1392
7	DF	0.35	0/1027	0.57	0/1392
7	GA	0.35	0/1027	0.58	0/1392
7	O	0.35	0/1027	0.58	0/1392
7	e	0.35	0/1027	0.57	0/1392
7	u	0.35	0/1027	0.58	0/1392
8	BE	0.48	0/1643	0.62	0/2228
8	DG	0.48	0/1643	0.62	0/2228
8	GB	0.48	0/1643	0.62	0/2228
8	P	0.48	0/1643	0.62	0/2228
8	f	0.48	0/1643	0.62	0/2228
8	v	0.48	0/1643	0.62	0/2228
All	All	0.46	18/318972 (0.0%)	0.68	144/433866 (0.0%)

Chiral center outliers are detected by calculating the chiral volume of a chiral center and verifying if the center is modelled as a planar moiety or with the opposite hand. A planarity outlier is detected by checking planarity of atoms in a peptide group, atoms in a mainchain group or atoms of a sidechain that are expected to be planar.

Mol	Chain	#Chirality outliers	#Planarity outliers
1	A	0	6
1	B	0	7
1	BF	0	6
1	BG	0	7
1	EA	0	6
1	EB	0	7
1	Q	0	6
1	R	0	7
1	g	0	6
1	h	0	7
1	w	0	6
1	x	0	7
2	C	0	31
2	CA	0	31
2	EC	0	31

*Continued on next page...*



*Continued from previous page...*

Mol	Chain	#Chirality outliers	#Planarity outliers
2	S	0	31
2	i	0	31
2	y	0	31
3	AA	0	4
3	CB	0	3
3	CC	0	4
3	D	0	3
3	E	0	4
3	ED	0	3
3	EE	0	4
3	T	0	3
3	U	0	4
3	j	0	3
3	k	0	4
3	z	0	3
5	AE	0	16
5	AF	0	24
5	AG	0	15
5	CG	0	16
5	DA	0	24
5	DB	0	15
5	FB	0	16
5	FC	0	24
5	FD	0	15
5	I	0	16
5	J	0	24
5	K	0	15
5	Y	0	16
5	Z	0	24
5	a	0	15
5	o	0	16
5	p	0	24
5	q	0	15
6	BA	0	2
6	BB	0	2
6	BC	0	2
6	DC	0	2
6	DD	0	2
6	DE	0	2
6	FE	0	2
6	FF	0	2
6	FG	0	2

*Continued on next page...*

*Continued from previous page...*

Mol	Chain	#Chirality outliers	#Planarity outliers
6	L	0	2
6	M	0	2
6	N	0	2
6	b	0	2
6	c	0	2
6	d	0	2
6	r	0	2
6	s	0	2
6	t	0	2
All	All	0	672

The worst 5 of 18 bond length outliers are listed below:

Mol	Chain	Res	Type	Atoms	Z	Observed(Å)	Ideal(Å)
2	C	613	LYS	C-N	6.92	1.47	1.34
2	i	613	LYS	C-N	6.91	1.47	1.34
2	EC	613	LYS	C-N	6.91	1.47	1.34
2	y	613	LYS	C-N	6.90	1.47	1.34
2	CA	613	LYS	C-N	6.90	1.47	1.34

The worst 5 of 144 bond angle outliers are listed below:

Mol	Chain	Res	Type	Atoms	Z	Observed(°)	Ideal(°)
5	AG	317	LEU	CA-CB-CG	7.88	133.42	115.30
5	DB	317	LEU	CA-CB-CG	7.87	133.41	115.30
5	q	317	LEU	CA-CB-CG	7.86	133.39	115.30
5	FD	317	LEU	CA-CB-CG	7.86	133.39	115.30
5	K	317	LEU	CA-CB-CG	7.85	133.35	115.30

There are no chirality outliers.

5 of 672 planarity outliers are listed below:

Mol	Chain	Res	Type	Group
1	A	186	ILE	Peptide
1	A	209	TRP	Peptide
1	A	262	PRO	Peptide
1	A	451	ASP	Peptide
1	A	6	VAL	Peptide

## 5.2 Too-close contacts [i](#)

Due to software issues we are unable to calculate clashes - this section is therefore empty.

## 5.3 Torsion angles [i](#)

### 5.3.1 Protein backbone [i](#)

In the following table, the Percentiles column shows the percent Ramachandran outliers of the chain as a percentile score with respect to all PDB entries followed by that with respect to all EM entries.

The Analysed column shows the number of residues for which the backbone conformation was analysed, and the total number of residues.

Mol	Chain	Analysed	Favoured	Allowed	Outliers	Percentiles	
1	A	656/660 (99%)	590 (90%)	59 (9%)	7 (1%)	14	52
1	B	646/660 (98%)	587 (91%)	56 (9%)	3 (0%)	29	69
1	BF	656/660 (99%)	589 (90%)	60 (9%)	7 (1%)	14	52
1	BG	646/660 (98%)	587 (91%)	56 (9%)	3 (0%)	29	69
1	EA	656/660 (99%)	589 (90%)	60 (9%)	7 (1%)	14	52
1	EB	646/660 (98%)	587 (91%)	56 (9%)	3 (0%)	29	69
1	Q	656/660 (99%)	590 (90%)	59 (9%)	7 (1%)	14	52
1	R	646/660 (98%)	587 (91%)	56 (9%)	3 (0%)	29	69
1	g	656/660 (99%)	589 (90%)	60 (9%)	7 (1%)	14	52
1	h	646/660 (98%)	587 (91%)	56 (9%)	3 (0%)	29	69
1	w	656/660 (99%)	589 (90%)	60 (9%)	7 (1%)	14	52
1	x	646/660 (98%)	587 (91%)	56 (9%)	3 (0%)	29	69
2	C	1000/1032 (97%)	817 (82%)	155 (16%)	28 (3%)	5	30
2	CA	1000/1032 (97%)	818 (82%)	154 (15%)	28 (3%)	5	30
2	EC	1000/1032 (97%)	818 (82%)	155 (16%)	27 (3%)	5	31
2	S	1000/1032 (97%)	818 (82%)	154 (15%)	28 (3%)	5	30
2	i	1000/1032 (97%)	818 (82%)	155 (16%)	27 (3%)	5	31
2	y	1000/1032 (97%)	818 (82%)	154 (15%)	28 (3%)	5	30
3	AA	330/334 (99%)	308 (93%)	21 (6%)	1 (0%)	41	76
3	CB	326/334 (98%)	307 (94%)	19 (6%)	0	100	100
3	CC	330/334 (99%)	308 (93%)	21 (6%)	1 (0%)	41	76

*Continued on next page...*

*Continued from previous page...*

Mol	Chain	Analysed	Favoured	Allowed	Outliers	Percentiles	
3	D	326/334 (98%)	307 (94%)	19 (6%)	0	100	100
3	E	330/334 (99%)	308 (93%)	21 (6%)	1 (0%)	41	76
3	ED	326/334 (98%)	307 (94%)	19 (6%)	0	100	100
3	EE	330/334 (99%)	308 (93%)	21 (6%)	1 (0%)	41	76
3	T	326/334 (98%)	307 (94%)	19 (6%)	0	100	100
3	U	330/334 (99%)	308 (93%)	21 (6%)	1 (0%)	41	76
3	j	326/334 (98%)	307 (94%)	19 (6%)	0	100	100
3	k	330/334 (99%)	308 (93%)	21 (6%)	1 (0%)	41	76
3	z	326/334 (98%)	307 (94%)	19 (6%)	0	100	100
4	AB	286/288 (99%)	262 (92%)	20 (7%)	4 (1%)	11	46
4	AC	286/288 (99%)	262 (92%)	20 (7%)	4 (1%)	11	46
4	AD	286/288 (99%)	262 (92%)	20 (7%)	4 (1%)	11	46
4	CD	286/288 (99%)	262 (92%)	20 (7%)	4 (1%)	11	46
4	CE	286/288 (99%)	262 (92%)	20 (7%)	4 (1%)	11	46
4	CF	286/288 (99%)	262 (92%)	20 (7%)	4 (1%)	11	46
4	EF	286/288 (99%)	262 (92%)	20 (7%)	4 (1%)	11	46
4	EG	286/288 (99%)	262 (92%)	20 (7%)	4 (1%)	11	46
4	F	286/288 (99%)	262 (92%)	20 (7%)	4 (1%)	11	46
4	FA	286/288 (99%)	262 (92%)	20 (7%)	4 (1%)	11	46
4	G	286/288 (99%)	262 (92%)	20 (7%)	4 (1%)	11	46
4	H	286/288 (99%)	262 (92%)	20 (7%)	4 (1%)	11	46
4	V	286/288 (99%)	262 (92%)	20 (7%)	4 (1%)	11	46
4	W	286/288 (99%)	262 (92%)	20 (7%)	4 (1%)	11	46
4	X	286/288 (99%)	262 (92%)	20 (7%)	4 (1%)	11	46
4	l	286/288 (99%)	262 (92%)	20 (7%)	4 (1%)	11	46
4	m	286/288 (99%)	262 (92%)	20 (7%)	4 (1%)	11	46
4	n	286/288 (99%)	262 (92%)	20 (7%)	4 (1%)	11	46
5	AE	598/602 (99%)	531 (89%)	53 (9%)	14 (2%)	6	34
5	AF	600/602 (100%)	518 (86%)	71 (12%)	11 (2%)	8	40
5	AG	600/602 (100%)	519 (86%)	69 (12%)	12 (2%)	7	38
5	CG	598/602 (99%)	531 (89%)	53 (9%)	14 (2%)	6	34

*Continued on next page...*

*Continued from previous page...*

Mol	Chain	Analysed	Favoured	Allowed	Outliers	Percentiles	
5	DA	600/602 (100%)	518 (86%)	71 (12%)	11 (2%)	8	40
5	DB	600/602 (100%)	519 (86%)	69 (12%)	12 (2%)	7	38
5	FB	598/602 (99%)	531 (89%)	53 (9%)	14 (2%)	6	34
5	FC	600/602 (100%)	518 (86%)	71 (12%)	11 (2%)	8	40
5	FD	600/602 (100%)	519 (86%)	69 (12%)	12 (2%)	7	38
5	I	598/602 (99%)	531 (89%)	53 (9%)	14 (2%)	6	34
5	J	600/602 (100%)	518 (86%)	71 (12%)	11 (2%)	8	40
5	K	600/602 (100%)	519 (86%)	69 (12%)	12 (2%)	7	38
5	Y	598/602 (99%)	531 (89%)	53 (9%)	14 (2%)	6	34
5	Z	600/602 (100%)	518 (86%)	71 (12%)	11 (2%)	8	40
5	a	600/602 (100%)	519 (86%)	69 (12%)	12 (2%)	7	38
5	o	598/602 (99%)	531 (89%)	53 (9%)	14 (2%)	6	34
5	p	600/602 (100%)	518 (86%)	71 (12%)	11 (2%)	8	40
5	q	600/602 (100%)	519 (86%)	69 (12%)	12 (2%)	7	38
6	BA	216/219 (99%)	205 (95%)	9 (4%)	2 (1%)	17	57
6	BB	216/219 (99%)	205 (95%)	9 (4%)	2 (1%)	17	57
6	BC	216/219 (99%)	205 (95%)	9 (4%)	2 (1%)	17	57
6	DC	216/219 (99%)	205 (95%)	9 (4%)	2 (1%)	17	57
6	DD	216/219 (99%)	205 (95%)	9 (4%)	2 (1%)	17	57
6	DE	216/219 (99%)	205 (95%)	9 (4%)	2 (1%)	17	57
6	FE	216/219 (99%)	205 (95%)	9 (4%)	2 (1%)	17	57
6	FF	216/219 (99%)	205 (95%)	9 (4%)	2 (1%)	17	57
6	FG	216/219 (99%)	205 (95%)	9 (4%)	2 (1%)	17	57
6	L	216/219 (99%)	205 (95%)	9 (4%)	2 (1%)	17	57
6	M	216/219 (99%)	205 (95%)	9 (4%)	2 (1%)	17	57
6	N	216/219 (99%)	205 (95%)	9 (4%)	2 (1%)	17	57
6	b	216/219 (99%)	205 (95%)	9 (4%)	2 (1%)	17	57
6	c	216/219 (99%)	205 (95%)	9 (4%)	2 (1%)	17	57
6	d	216/219 (99%)	205 (95%)	9 (4%)	2 (1%)	17	57
6	r	216/219 (99%)	205 (95%)	9 (4%)	2 (1%)	17	57
6	s	216/219 (99%)	205 (95%)	9 (4%)	2 (1%)	17	57

*Continued on next page...*

Continued from previous page...

Mol	Chain	Analysed	Favoured	Allowed	Outliers	Percentiles	
6	t	216/219 (99%)	205 (95%)	9 (4%)	2 (1%)	17	57
7	BD	124/132 (94%)	116 (94%)	8 (6%)	0	100	100
7	DF	124/132 (94%)	116 (94%)	8 (6%)	0	100	100
7	GA	124/132 (94%)	116 (94%)	8 (6%)	0	100	100
7	O	124/132 (94%)	116 (94%)	8 (6%)	0	100	100
7	e	124/132 (94%)	116 (94%)	8 (6%)	0	100	100
7	u	124/132 (94%)	116 (94%)	8 (6%)	0	100	100
8	BE	191/196 (97%)	172 (90%)	19 (10%)	0	100	100
8	DG	191/196 (97%)	172 (90%)	19 (10%)	0	100	100
8	GB	191/196 (97%)	172 (90%)	19 (10%)	0	100	100
8	P	191/196 (97%)	172 (90%)	19 (10%)	0	100	100
8	f	191/196 (97%)	172 (90%)	19 (10%)	0	100	100
8	v	191/196 (97%)	172 (90%)	19 (10%)	0	100	100
All	All	39462/40050 (98%)	35197 (89%)	3703 (9%)	562 (1%)	15	46

5 of 562 Ramachandran outliers are listed below:

Mol	Chain	Res	Type
4	F	249	ILE
4	G	249	ILE
4	H	249	ILE
5	I	10	VAL
5	I	24	ILE

### 5.3.2 Protein sidechains [i](#)

In the following table, the Percentiles column shows the percent sidechain outliers of the chain as a percentile score with respect to all PDB entries followed by that with respect to all EM entries.

The Analysed column shows the number of residues for which the sidechain conformation was analysed, and the total number of residues.

Mol	Chain	Analysed	Rotameric	Outliers	Percentiles	
1	A	576/578 (100%)	576 (100%)	0	100	100
1	B	567/578 (98%)	567 (100%)	0	100	100
1	BF	576/578 (100%)	576 (100%)	0	100	100

Continued on next page...

*Continued from previous page...*

Mol	Chain	Analysed	Rotameric	Outliers	Percentiles	
1	BG	567/578 (98%)	567 (100%)	0	100	100
1	EA	576/578 (100%)	576 (100%)	0	100	100
1	EB	567/578 (98%)	567 (100%)	0	100	100
1	Q	576/578 (100%)	576 (100%)	0	100	100
1	R	567/578 (98%)	567 (100%)	0	100	100
1	g	576/578 (100%)	576 (100%)	0	100	100
1	h	567/578 (98%)	567 (100%)	0	100	100
1	w	576/578 (100%)	576 (100%)	0	100	100
1	x	567/578 (98%)	567 (100%)	0	100	100
2	C	896/921 (97%)	894 (100%)	2 (0%)	93	96
2	CA	896/921 (97%)	894 (100%)	2 (0%)	93	96
2	EC	896/921 (97%)	894 (100%)	2 (0%)	93	96
2	S	896/921 (97%)	894 (100%)	2 (0%)	93	96
2	i	896/921 (97%)	894 (100%)	2 (0%)	93	96
2	y	896/921 (97%)	894 (100%)	2 (0%)	93	96
3	AA	293/295 (99%)	291 (99%)	2 (1%)	84	90
3	CB	289/295 (98%)	288 (100%)	1 (0%)	92	95
3	CC	293/295 (99%)	291 (99%)	2 (1%)	84	90
3	D	289/295 (98%)	287 (99%)	2 (1%)	84	90
3	E	293/295 (99%)	291 (99%)	2 (1%)	84	90
3	ED	289/295 (98%)	287 (99%)	2 (1%)	84	90
3	EE	293/295 (99%)	291 (99%)	2 (1%)	84	90
3	T	289/295 (98%)	287 (99%)	2 (1%)	84	90
3	U	293/295 (99%)	291 (99%)	2 (1%)	84	90
3	j	289/295 (98%)	287 (99%)	2 (1%)	84	90
3	k	293/295 (99%)	291 (99%)	2 (1%)	84	90
3	z	289/295 (98%)	287 (99%)	2 (1%)	84	90
4	AB	244/244 (100%)	244 (100%)	0	100	100
4	AC	244/244 (100%)	244 (100%)	0	100	100
4	AD	244/244 (100%)	244 (100%)	0	100	100
4	CD	244/244 (100%)	244 (100%)	0	100	100

*Continued on next page...*

*Continued from previous page...*

Mol	Chain	Analysed	Rotameric	Outliers	Percentiles	
4	CE	244/244 (100%)	244 (100%)	0	100	100
4	CF	244/244 (100%)	244 (100%)	0	100	100
4	EF	244/244 (100%)	244 (100%)	0	100	100
4	EG	244/244 (100%)	244 (100%)	0	100	100
4	F	244/244 (100%)	244 (100%)	0	100	100
4	FA	244/244 (100%)	244 (100%)	0	100	100
4	G	244/244 (100%)	244 (100%)	0	100	100
4	H	244/244 (100%)	244 (100%)	0	100	100
4	V	244/244 (100%)	244 (100%)	0	100	100
4	W	244/244 (100%)	244 (100%)	0	100	100
4	X	244/244 (100%)	244 (100%)	0	100	100
4	l	244/244 (100%)	244 (100%)	0	100	100
4	m	244/244 (100%)	244 (100%)	0	100	100
4	n	244/244 (100%)	244 (100%)	0	100	100
5	AE	519/519 (100%)	519 (100%)	0	100	100
5	AF	519/519 (100%)	518 (100%)	1 (0%)	93	96
5	AG	519/519 (100%)	519 (100%)	0	100	100
5	CG	519/519 (100%)	519 (100%)	0	100	100
5	DA	519/519 (100%)	518 (100%)	1 (0%)	93	96
5	DB	519/519 (100%)	519 (100%)	0	100	100
5	FB	519/519 (100%)	519 (100%)	0	100	100
5	FC	519/519 (100%)	518 (100%)	1 (0%)	93	96
5	FD	519/519 (100%)	519 (100%)	0	100	100
5	I	519/519 (100%)	519 (100%)	0	100	100
5	J	519/519 (100%)	518 (100%)	1 (0%)	93	96
5	K	519/519 (100%)	519 (100%)	0	100	100
5	Y	519/519 (100%)	519 (100%)	0	100	100
5	Z	519/519 (100%)	518 (100%)	1 (0%)	93	96
5	a	519/519 (100%)	519 (100%)	0	100	100
5	o	519/519 (100%)	519 (100%)	0	100	100
5	p	519/519 (100%)	518 (100%)	1 (0%)	93	96

*Continued on next page...*



*Continued from previous page...*

Mol	Chain	Analysed	Rotameric	Outliers	Percentiles	
5	q	519/519 (100%)	519 (100%)	0	100	100
6	BA	187/188 (100%)	187 (100%)	0	100	100
6	BB	187/188 (100%)	187 (100%)	0	100	100
6	BC	187/188 (100%)	187 (100%)	0	100	100
6	DC	187/188 (100%)	187 (100%)	0	100	100
6	DD	187/188 (100%)	187 (100%)	0	100	100
6	DE	187/188 (100%)	187 (100%)	0	100	100
6	FE	187/188 (100%)	187 (100%)	0	100	100
6	FF	187/188 (100%)	187 (100%)	0	100	100
6	FG	187/188 (100%)	187 (100%)	0	100	100
6	L	187/188 (100%)	187 (100%)	0	100	100
6	M	187/188 (100%)	187 (100%)	0	100	100
6	N	187/188 (100%)	187 (100%)	0	100	100
6	b	187/188 (100%)	187 (100%)	0	100	100
6	c	187/188 (100%)	187 (100%)	0	100	100
6	d	187/188 (100%)	187 (100%)	0	100	100
6	r	187/188 (100%)	187 (100%)	0	100	100
6	s	187/188 (100%)	187 (100%)	0	100	100
6	t	187/188 (100%)	187 (100%)	0	100	100
7	BD	118/123 (96%)	118 (100%)	0	100	100
7	DF	118/123 (96%)	118 (100%)	0	100	100
7	GA	118/123 (96%)	118 (100%)	0	100	100
7	O	118/123 (96%)	118 (100%)	0	100	100
7	e	118/123 (96%)	118 (100%)	0	100	100
7	u	118/123 (96%)	118 (100%)	0	100	100
8	BE	166/169 (98%)	165 (99%)	1 (1%)	86	92
8	DG	166/169 (98%)	165 (99%)	1 (1%)	86	92
8	GB	166/169 (98%)	165 (99%)	1 (1%)	86	92
8	P	166/169 (98%)	165 (99%)	1 (1%)	86	92
8	f	166/169 (98%)	165 (99%)	1 (1%)	86	92
8	v	166/169 (98%)	165 (99%)	1 (1%)	86	92

*Continued on next page...*

*Continued from previous page...*

Mol	Chain	Analysed	Rotameric	Outliers	Percentiles
All	All	34530/34872 (99%)	34483 (100%)	47 (0%)	93 97

5 of 47 residues with a non-rotameric sidechain are listed below:

Mol	Chain	Res	Type
3	AA	28	ILE
3	CC	28	ILE
3	AA	274	ILE
2	CA	704	LEU
5	DA	249	ASP

Sometimes sidechains can be flipped to improve hydrogen bonding and reduce clashes. 5 of 671 such sidechains are listed below:

Mol	Chain	Res	Type
1	BG	281	ASN
1	EB	84	ASN
2	CA	333	ASN
1	BG	195	ASN
5	CG	387	ASN

### 5.3.3 RNA [i](#)

There are no RNA molecules in this entry.

### 5.4 Non-standard residues in protein, DNA, RNA chains [i](#)

There are no non-standard protein/DNA/RNA residues in this entry.

### 5.5 Carbohydrates [i](#)

There are no monosaccharides in this entry.

### 5.6 Ligand geometry [i](#)

There are no ligands in this entry.

## 5.7 Other polymers [i](#)

There are no such residues in this entry.

## 5.8 Polymer linkage issues [i](#)

The following chains have linkage breaks:

Mol	Chain	Number of breaks
5	I	1
5	Y	1
5	o	1
5	CG	1
5	FB	1
5	AE	1
2	i	1
2	CA	1
2	EC	1
2	C	1
2	S	1
2	y	1

The worst 5 of 12 chain breaks are listed below:

Model	Chain	Residue-1	Atom-1	Residue-2	Atom-2	Distance (Å)
1	I	570:ARG	C	571:GLU	N	3.75
1	Y	570:ARG	C	571:GLU	N	3.75
1	o	570:ARG	C	571:GLU	N	3.75
1	CG	570:ARG	C	571:GLU	N	3.75
1	FB	570:ARG	C	571:GLU	N	3.75

## 6 Map visualisation [i](#)

This section contains visualisations of the EMDB entry EMD-3396. These allow visual inspection of the internal detail of the map and identification of artifacts.

No raw map or half-maps were deposited for this entry and therefore no images, graphs, etc. pertaining to the raw map can be shown.

### 6.1 Orthogonal projections [i](#)

#### 6.1.1 Primary map

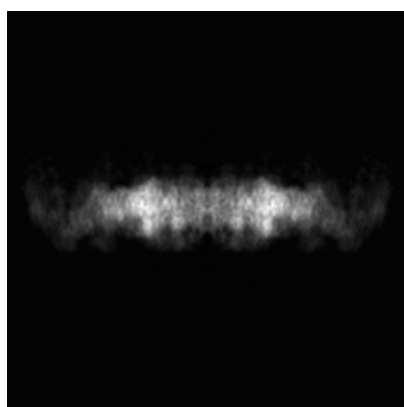

X

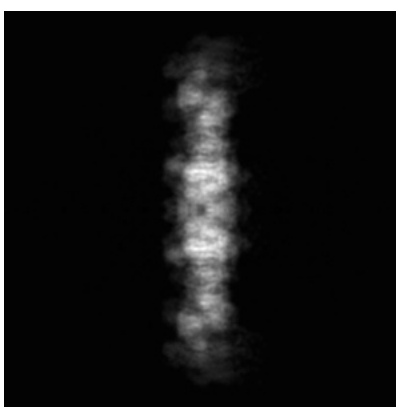

Y

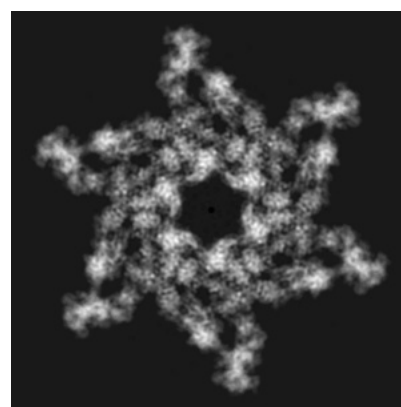

Z

The images above show the map projected in three orthogonal directions.

### 6.2 Central slices [i](#)

#### 6.2.1 Primary map

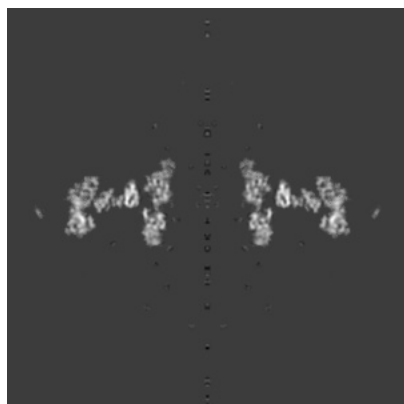

X Index: 240

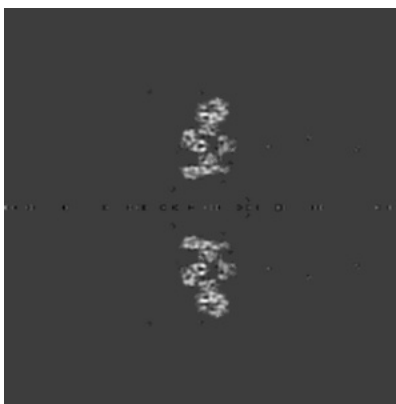

Y Index: 240

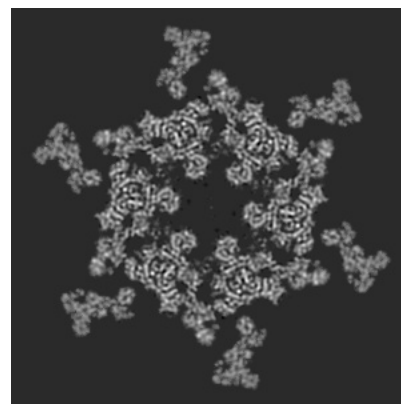

Z Index: 240

The images above show central slices of the map in three orthogonal directions.

## 6.3 Largest variance slices [i](#)

### 6.3.1 Primary map

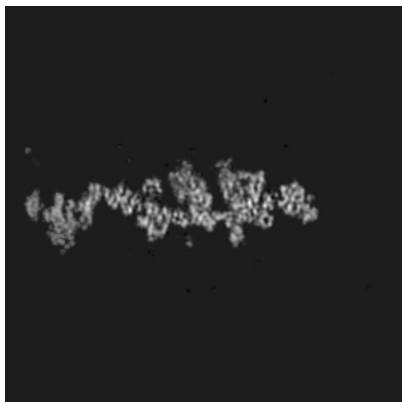

X Index: 286

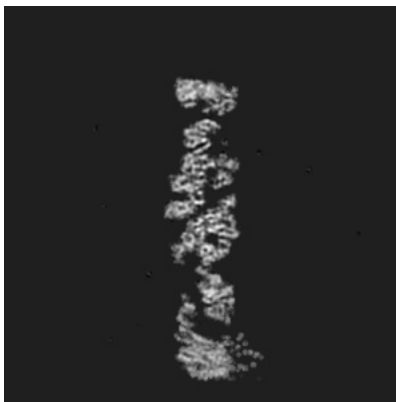

Y Index: 310

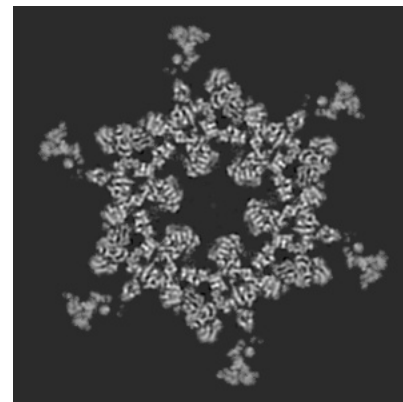

Z Index: 247

The images above show the largest variance slices of the map in three orthogonal directions.

## 6.4 Orthogonal surface views [i](#)

### 6.4.1 Primary map



X



Y



Z

The images above show the 3D surface view of the map at the recommended contour level 0.0095. These images, in conjunction with the slice images, may facilitate assessment of whether an appropriate contour level has been provided.

## 6.5 Mask visualisation

This section was not generated. No masks/segmentation were deposited.

## 7 Map analysis [i](#)

This section contains the results of statistical analysis of the map.

### 7.1 Map-value distribution [i](#)

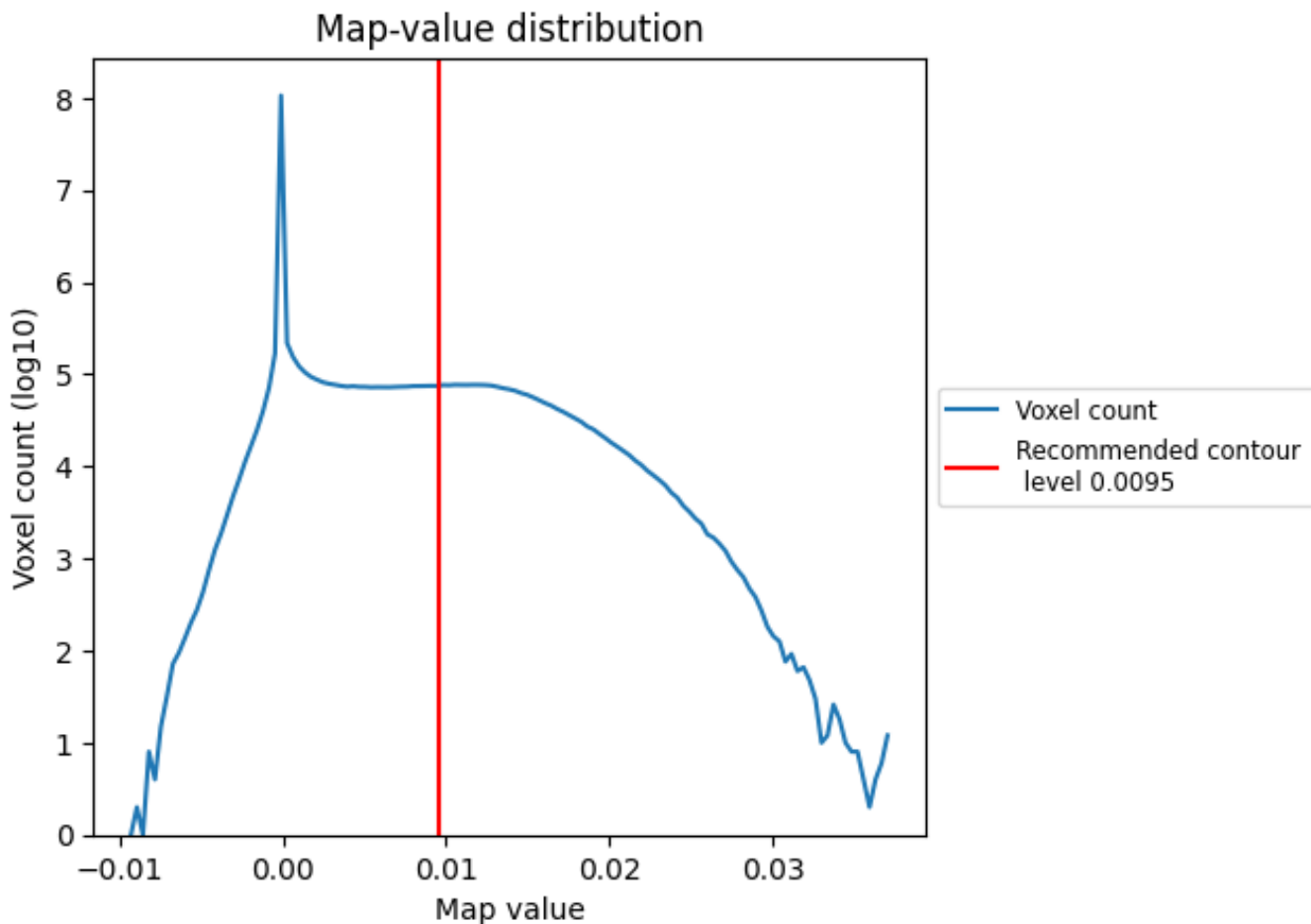

The map-value distribution is plotted in 128 intervals along the x-axis. The y-axis is logarithmic. A spike in this graph at zero usually indicates that the volume has been masked.

## 7.2 Volume estimate [\(i\)](#)

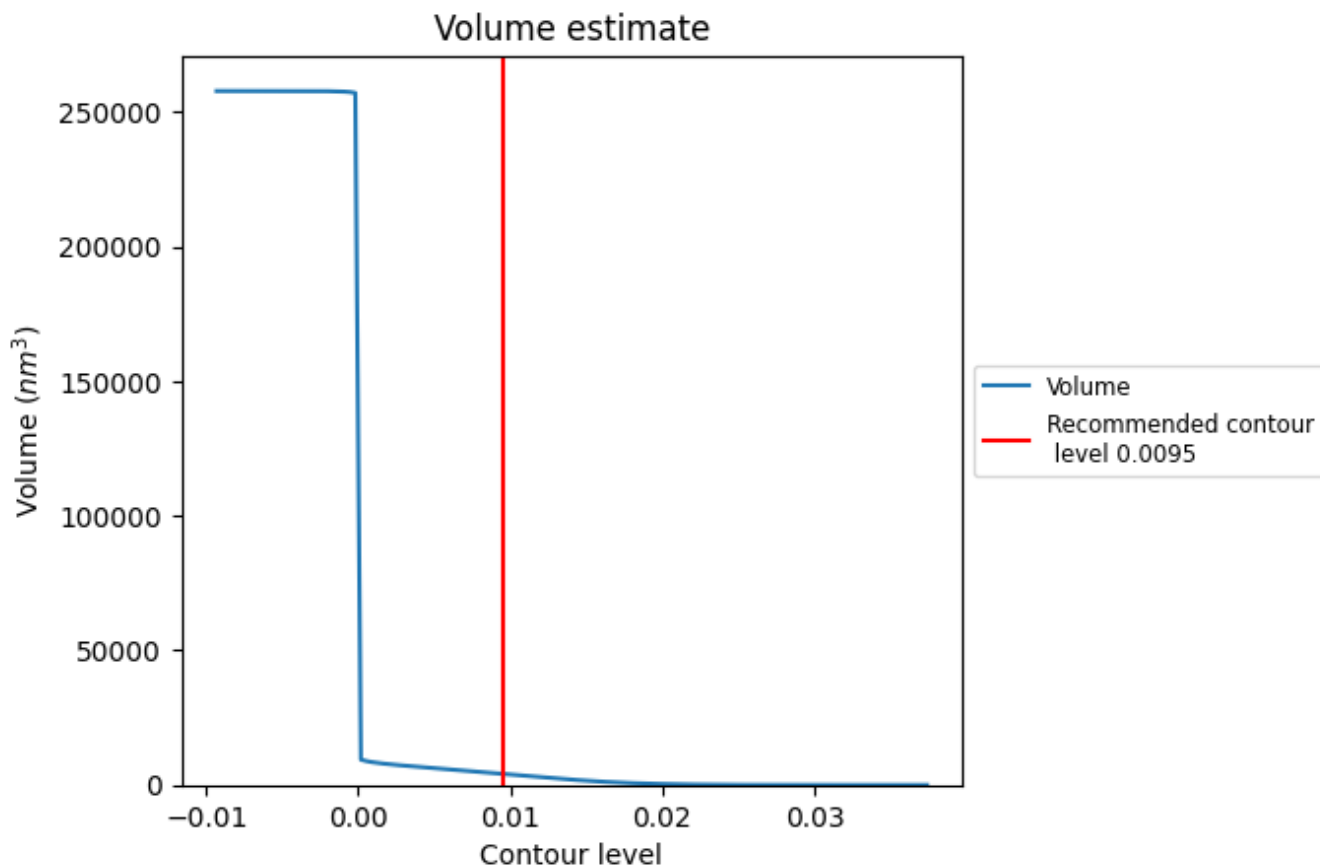

The volume at the recommended contour level is 4148  $\text{nm}^3$ ; this corresponds to an approximate mass of 3747 kDa.

The volume estimate graph shows how the enclosed volume varies with the contour level. The recommended contour level is shown as a vertical line and the intersection between the line and the curve gives the volume of the enclosed surface at the given level.



### 7.3 Rotationally averaged power spectrum i

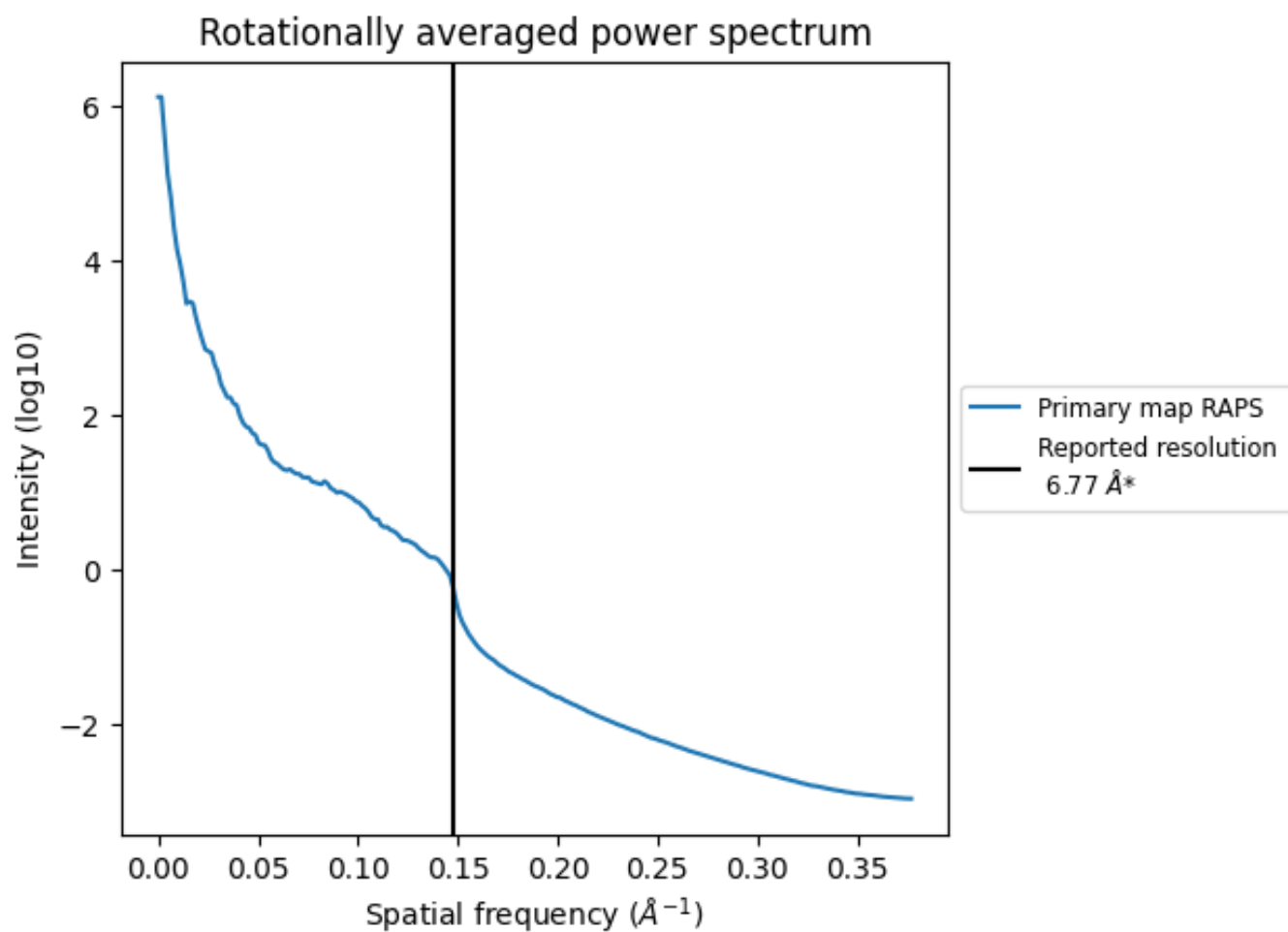

\*Reported resolution corresponds to spatial frequency of 0.148 Å<sup>-1</sup>

## 8 Fourier-Shell correlation [i](#)

Fourier-Shell Correlation (FSC) is the most commonly used method to estimate the resolution of single-particle and subtomogram-averaged maps. The shape of the curve depends on the imposed symmetry, mask and whether or not the two 3D reconstructions used were processed from a common reference. The reported resolution is shown as a black line. A curve is displayed for the half-bit criterion in addition to lines showing the 0.143 gold standard cut-off and 0.5 cut-off.

### 8.1 FSC [i](#)

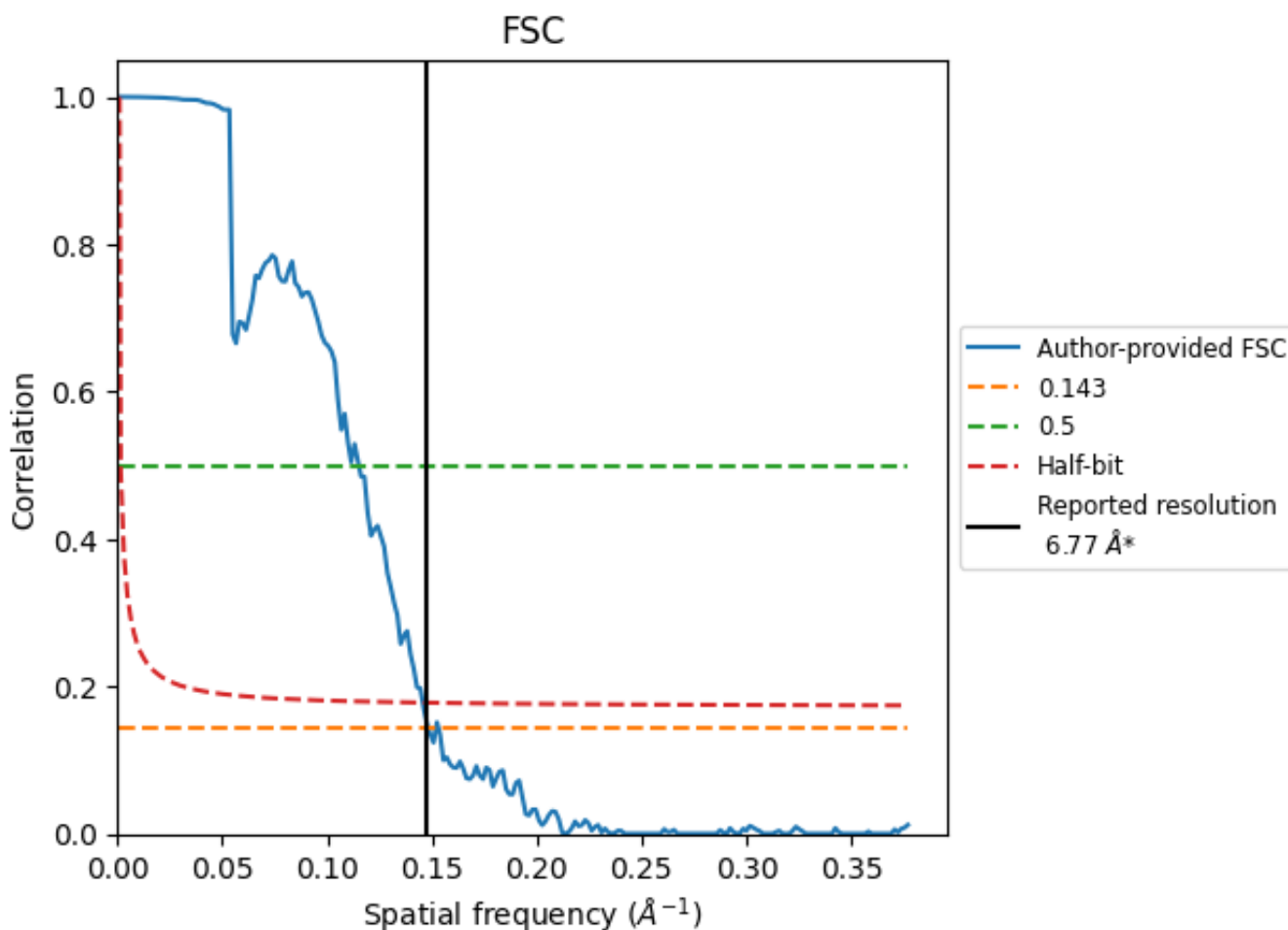

\*Reported resolution corresponds to spatial frequency of 0.148 Å<sup>-1</sup>

## 8.2 Resolution estimates [i](#)

Resolution estimate (Å)	Estimation criterion (FSC cut-off)		
	0.143	0.5	Half-bit
Reported by author	6.77	-	-
Author-provided FSC curve	6.74	8.69	6.87
Unmasked-calculated*	-	-	-

\*Resolution estimate based on FSC curve calculated by comparison of deposited half-maps.

## 9 Map-model fit [i](#)

This section contains information regarding the fit between EMDB map EMD-3396 and PDB model 5IV7. Per-residue inclusion information can be found in section 3 on page 13.

### 9.1 Map-model overlay [i](#)

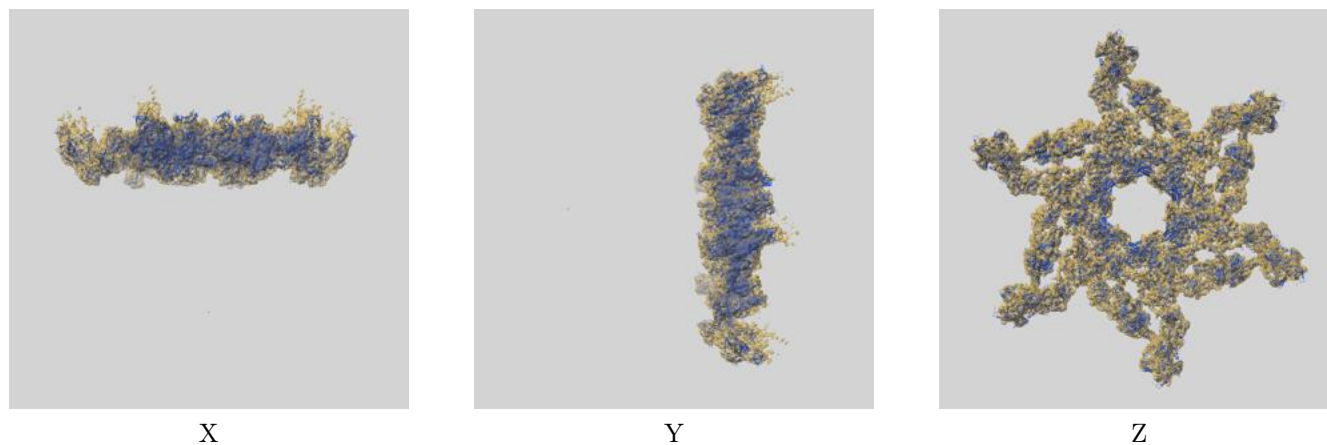

The images above show the 3D surface view of the map at the recommended contour level 0.0095 at 50% transparency in yellow overlaid with a ribbon representation of the model coloured in blue. These images allow for the visual assessment of the quality of fit between the atomic model and the map.

## 9.2 Q-score mapped to coordinate model [i](#)

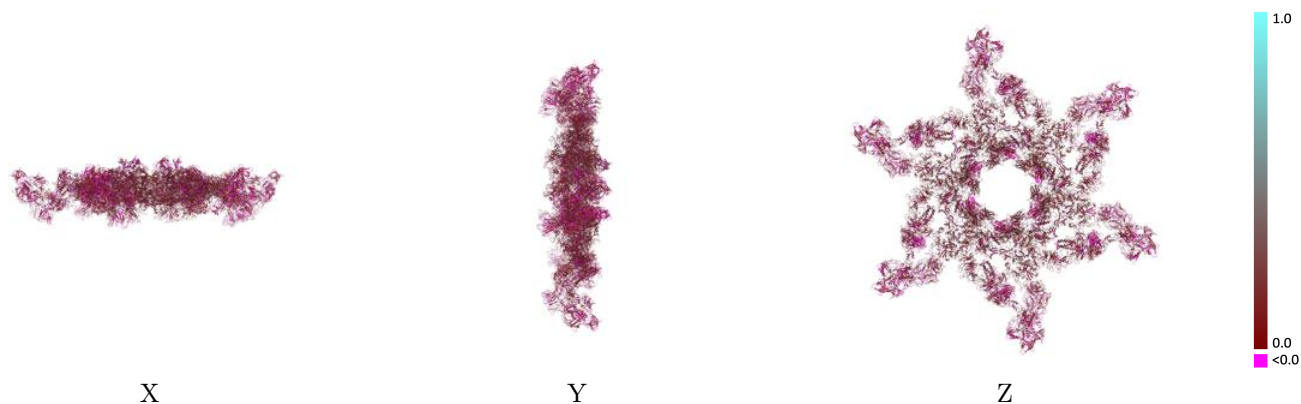

The images above show the model with each residue coloured according its Q-score. This shows their resolvability in the map with higher Q-score values reflecting better resolvability. Please note: Q-score is calculating the resolvability of atoms, and thus high values are only expected at resolutions at which atoms can be resolved. Low Q-score values may therefore be expected for many entries.

## 9.3 Atom inclusion mapped to coordinate model [i](#)

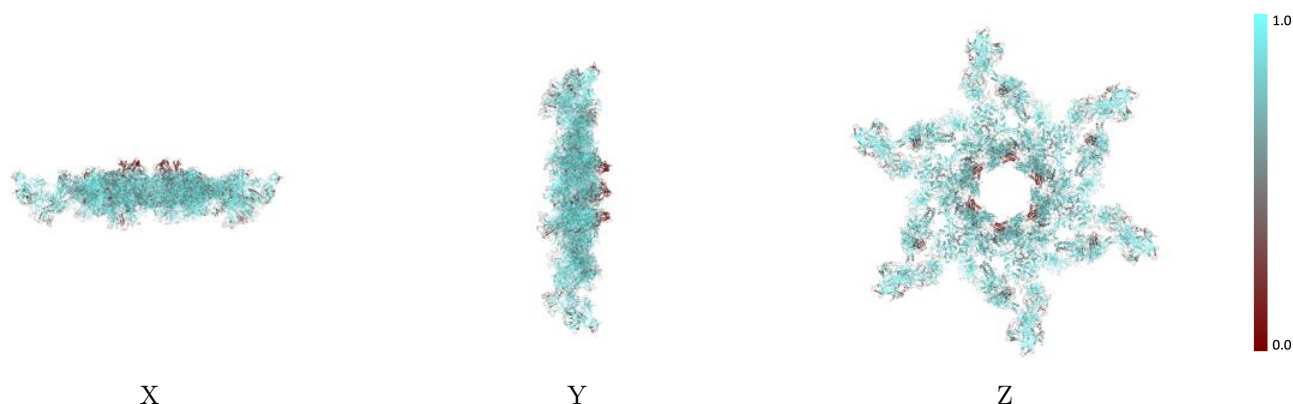

The images above show the model with each residue coloured according to its atom inclusion. This shows to what extent they are inside the map at the recommended contour level (0.0095).



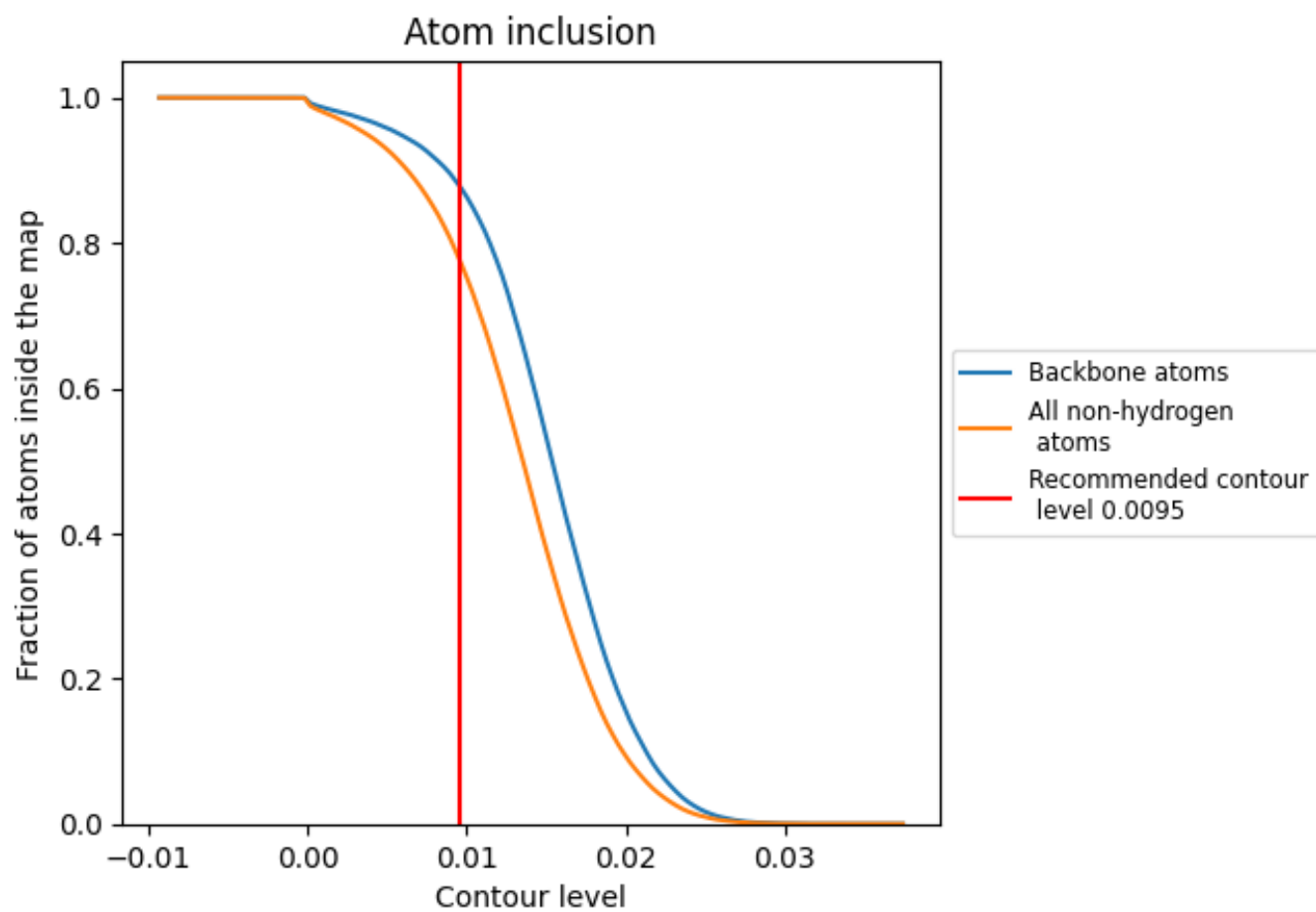



































































## 9.4 Atom inclusion [i](#)



At the recommended contour level, 88% of all backbone atoms, 78% of all non-hydrogen atoms, are inside the map.

## 9.5 Map-model fit summary





















































































The table lists the average atom inclusion at the recommended contour level (0.0095) and Q-score for the entire model and for each chain.

Chain	Atom inclusion	Q-score
All	 0.7794	 0.1500
A	 0.8073	 0.1770
AA	 0.8179	 0.1670
AB	 0.7570	 0.1360
AC	 0.7365	 0.1300
AD	 0.6909	 0.1170
AE	 0.7801	 0.1310
AF	 0.7292	 0.1260
AG	 0.7620	 0.1440
B	 0.7964	 0.1830
BA	 0.7204	 0.0920
BB	 0.7374	 0.0890
BC	 0.8316	 0.0980
BD	 0.2747	 0.0820
BE	 0.8293	 0.1800
BF	 0.8111	 0.1750
BG	 0.8011	 0.1820
C	 0.8602	 0.1800
CA	 0.8582	 0.1810
CB	 0.8495	 0.1760
CC	 0.8183	 0.1700
CD	 0.7505	 0.1350
CE	 0.7630	 0.1420
CF	 0.6741	 0.1060
CG	 0.7840	 0.1310
D	 0.8471	 0.1750
DA	 0.7329	 0.1290
DB	 0.7605	 0.1420
DC	 0.7362	 0.1050
DD	 0.6967	 0.0750
DE	 0.8091	 0.0940
DF	 0.2556	 0.0670
DG	 0.8318	 0.1800
E	 0.8183	 0.1700
EA	 0.8078	 0.1770



*Continued on next page...*









































*Continued from previous page...*

Chain	Atom inclusion	Q-score
EB	 0.7968	 0.1820
EC	 0.8564	 0.1810
ED	 0.8475	 0.1760
EE	 0.8168	 0.1700
EF	 0.7588	 0.1340
EG	 0.7602	 0.1410
F	 0.7486	 0.1260
FA	 0.6788	 0.1150
FB	 0.7853	 0.1350
FC	 0.7266	 0.1250
FD	 0.7627	 0.1400
FE	 0.7210	 0.1000
FF	 0.7429	 0.0870
FG	 0.8298	 0.1000
G	 0.7565	 0.1410
GA	 0.2606	 0.0790
GB	 0.8363	 0.1820
H	 0.6848	 0.1130
I	 0.7809	 0.1310
J	 0.7298	 0.1280
K	 0.7622	 0.1450
L	 0.7155	 0.0900
M	 0.7380	 0.0870
N	 0.8274	 0.0970
O	 0.2758	 0.0740
P	 0.8293	 0.1810
Q	 0.8115	 0.1740
R	 0.8027	 0.1840
S	 0.8560	 0.1800
T	 0.8510	 0.1730
U	 0.8195	 0.1710
V	 0.7514	 0.1370
W	 0.7649	 0.1460
X	 0.6736	 0.1090
Y	 0.7766	 0.1290
Z	 0.7329	 0.1290
a	 0.7596	 0.1410
b	 0.7356	 0.1020
c	 0.6942	 0.0710
d	 0.8140	 0.0920
e	 0.2626	 0.0700
f	 0.8267	 0.1770

*Continued on next page...*



*Continued from previous page...*

Chain	Atom inclusion	Q-score
g	 0.8078	 0.1760
h	 0.7958	 0.1830
i	 0.8572	 0.1810
j	 0.8491	 0.1750
k	 0.8172	 0.1690
l	 0.7500	 0.1340
m	 0.7598	 0.1430
n	 0.6750	 0.1110
o	 0.7866	 0.1340
p	 0.7246	 0.1240
q	 0.7603	 0.1410
r	 0.7228	 0.0990
s	 0.7429	 0.0820
t	 0.8255	 0.0990
u	 0.2626	 0.0850
v	 0.8344	 0.1800
w	 0.8082	 0.1790
x	 0.7958	 0.1820
y	 0.8601	 0.1810
z	 0.8440	 0.1770