



# wwPDB EM Validation Summary Report ⓘ

Jun 6, 2023 – 09:37 PM JST

PDB ID : 8GZU  
EMDB ID : EMD-34403  
Title : Cryo-EM structure of Tetrahymena thermophila respiratory Megacomplex MC (IV<sup>2</sup>+I+III<sup>2</sup>+II)<sup>2</sup>  
Authors : Wu, M.C.; Hu, Y.Q.; Han, F.Z.; Zhou, L.  
Deposited on : 2022-09-27  
Resolution : 4.18 Å(reported)

This is a wwPDB EM Validation Summary Report for a publicly released PDB entry.

We welcome your comments at [validation@mail.wwpdb.org](mailto:validation@mail.wwpdb.org)

A user guide is available at

<https://www.wwpdb.org/validation/2017/EMValidationReportHelp>

with specific help available everywhere you see the ⓘ symbol.

The types of validation reports are described at

<http://www.wwpdb.org/validation/2017/FAQs#types>.

---

The following versions of software and data (see [references ⓘ](#)) were used in the production of this report:

EMDB validation analysis : 0.0.1.dev50  
Mogul : 1.8.5 (274361), CSD as541be (2020)  
MolProbity : 4.02b-467  
buster-report : 1.1.7 (2018)  
Percentile statistics : 20191225.v01 (using entries in the PDB archive December 25th 2019)  
MapQ : 1.9.9  
Ideal geometry (proteins) : Engh & Huber (2001)  
Ideal geometry (DNA, RNA) : Parkinson et al. (1996)  
Validation Pipeline (wwPDB-VP) : 2.33

# 1 Overall quality at a glance

The following experimental techniques were used to determine the structure:  
*ELECTRON MICROSCOPY*

The reported resolution of this entry is 4.18 Å.

Percentile scores (ranging between 0-100) for global validation metrics of the entry are shown in the following graphic. The table shows the number of entries on which the scores are based.

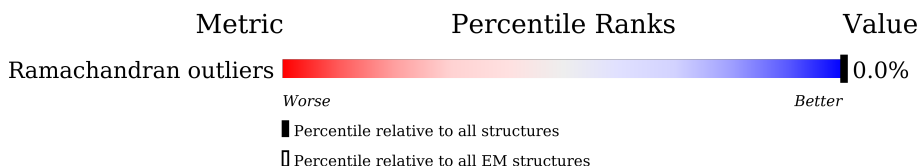





Metric	Whole archive (#Entries)	EM structures (#Entries)
Ramachandran outliers	154571	4023

The table below summarises the geometric issues observed across the polymeric chains and their fit to the map. The red, orange, yellow and green segments of the bar indicate the fraction of residues that contain outliers for  $\geq 3$ , 2, 1 and 0 types of geometric quality criteria respectively. A grey segment represents the fraction of residues that are not modelled. The numeric value for each fraction is indicated below the corresponding segment, with a dot representing fractions  $\leq 5\%$ . The upper red bar (where present) indicates the fraction of residues that have poor fit to the EM map (all-atom inclusion  $< 40\%$ ). The numeric value is given above the bar.

Mol	Chain	Length	Quality of chain
1	00	490	15% 92% 8%
1	55	490	21% 92% 8%
1	A	490	92% 8%
1	a	490	92% 8%
2	01	473	39% 90% 10%
2	56	473	21% 90% 10%
2	B	473	5% 90% 10%
2	b	473	90% 10%
3	02	212	55% 95% .
3	57	212	12% 95% .
3	C	212	95% .

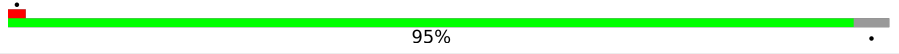
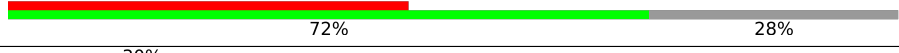
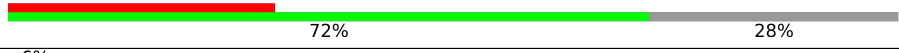
*Continued on next page...*

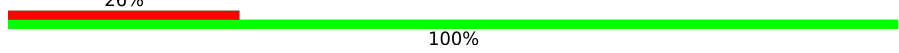
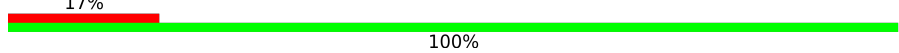
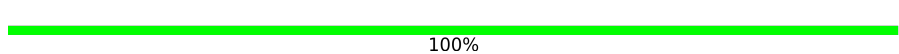
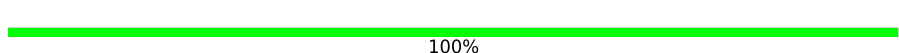
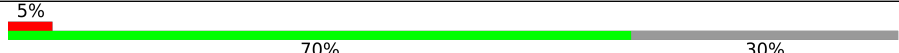
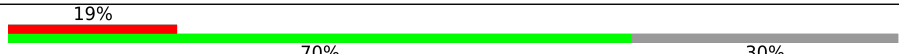
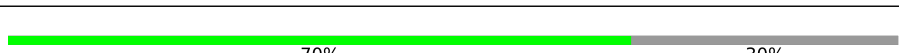
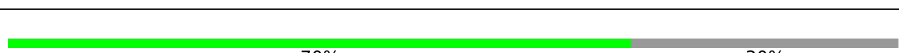
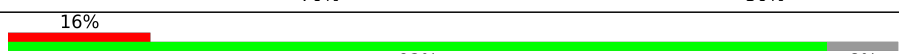
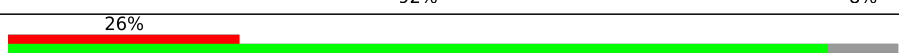
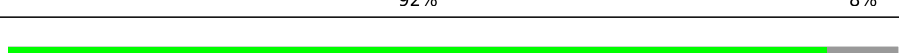
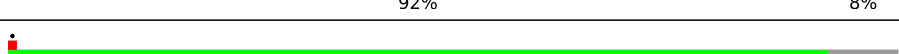
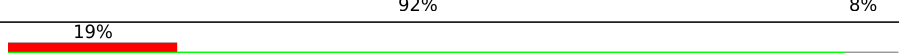
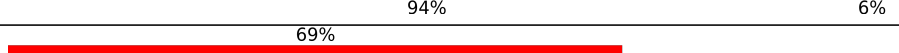
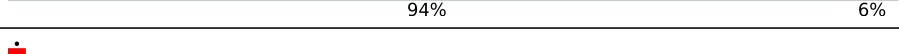
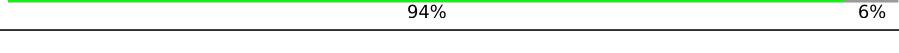
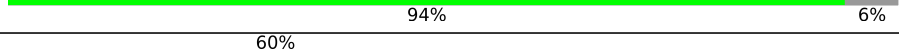
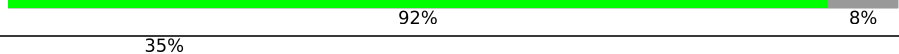
Continued from previous page...

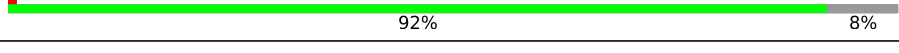
Mol	Chain	Length	Quality of chain
3	c	212	 95%
4	03	402	 45% 72% 28%
4	58	402	 30% 72% 28%
4	D	402	 6% 72% 28%
4	d	402	 72% 28%
5	04	385	 26% 100%
5	59	385	 17% 100%
5	E	385	 100%
5	e	385	 100%
6	05	348	 5% 70% 30%
6	60	348	 19% 70% 30%
6	F	348	 70% 30%
6	f	348	 70% 30%
7	06	318	 16% 92% 8%
7	61	318	 26% 92% 8%
7	G	318	 92% 8%
7	g	318	 92% 8%
8	07	318	 19% 94% 6%
8	62	318	 69% 94% 6%
8	H	318	 94% 6%
8	h	318	 94% 6%
9	08	252	 60% 92% 8%
9	63	252	 35% 91% 8%
9	I	252	 92% 8%
9	i	252	 91% 8%

Continued on next page...

Continued from previous page...

Mol	Chain	Length	Quality of chain
10	09	234	20% 80% 20%
10	64	234	42% 80% 20%
10	J	234	80% 20%
10	j	234	80% 20%
11	0A	72	36% 97% 20%
11	45	72	53% 97% 20%
11	6T	72	97% 20%
11	6t	72	97% 20%
12	0B	462	71% 82% 18%
12	46	462	11% 82% 18%
12	BP	462	82% 18%
12	bp	462	82% 18%
13	0C	188	25% 100%
13	47	188	9% 100%
13	FS	188	100%
13	fs	188	100%
14	0D	127	23% 79% 21%
14	48	127	20% 79% 21%
14	4A	127	79% 21%
14	4a	127	79% 21%
15	0E	453	19% 76% 24%
15	49	453	22% 76% 24%
15	Y7	453	76% 24%
15	y7	453	76% 24%
16	0F	190	25% 100%

Continued on next page...

Continued from previous page...

Mol	Chain	Length	Quality of chain
16	50	190	63% 100%
16	Y5	190	100%
16	y5	190	100%
17	0G	89	37% 100%
17	51	89	27% 100%
17	Y0	89	100%
17	y0	89	100%
18	0H	100	13% 97%
18	52	100	57% 97%
18	Z1	100	97%
18	z1	100	97%
19	0I	92	42% 100%
19	53	92	73% 100%
19	U1	92	100%
19	u1	92	5% 100%
20	0J	17	47% 100%
20	54	17	59% 100%
20	QM	17	12% 100%
20	Qm	17	100%
20	U2	17	6% 100%
20	qM	17	29% 100%
20	qm	17	53% 100%
20	u2	17	12% 100%
21	10	231	21% 90% 10%
21	65	231	32% 90% 10%

Continued on next page...

Continued from previous page...

Mol	Chain	Length	Quality of chain
21	K	231	90% 10%
21	k	231	90% 10%
22	11	222	60% 87% 13%
22	66	222	28% 87% 13%
22	L	222	87% 13%
22	l	222	87% 13%
23	12	220	31% 100%
23	67	220	52% 100%
23	M	220	100%
23	m	220	100%
24	13	210	40% 98%
24	68	210	61% 98%
24	N	210	98%
24	n	210	98%
25	14	193	38% 67% 33%
25	69	193	35% 67% 33%
25	O	193	67% 33%
25	o	193	67% 33%
26	15	175	27% 100%
26	70	175	19% 100%
26	P	175	100%
26	p	175	100%
27	16	173	39% 100%
27	71	173	21% 100%
27	Q	173	100%









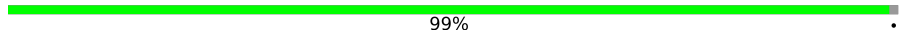
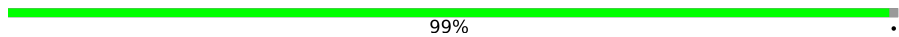

Continued on next page...

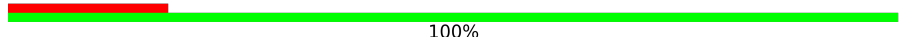
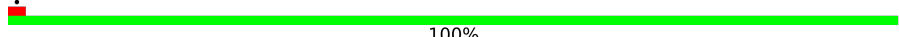
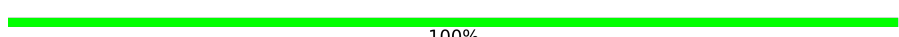
Continued from previous page...

Mol	Chain	Length	Quality of chain
27	q	173	100%
28	17	173	68%
28	72	173	99%
28	R	173	99%
28	r	173	99%
29	18	170	68%
29	73	170	18%
29	S	170	99%
29	s	170	99%
30	19	158	32%
30	74	158	29%
30	T	158	99%
30	t	158	99%
31	1B	59	99%
31	1b	59	19%
32	20	154	9%
32	75	154	70%
32	U	154	99%
32	u	154	99%
33	21	149	11%
33	76	149	54%
33	V	149	98%
33	v	149	98%
34	22	124	40%
34	77	124	52%

Continued on next page...



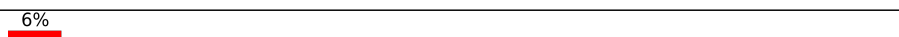
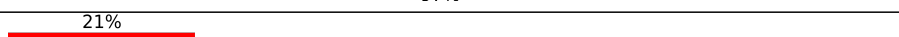
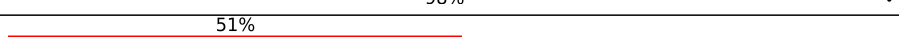
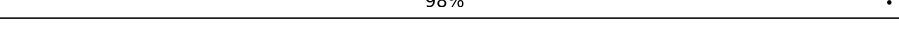
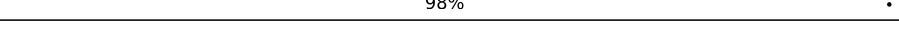
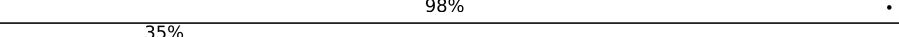
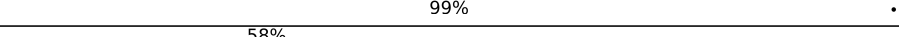
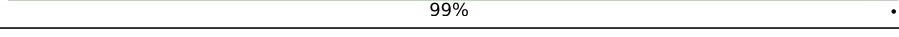
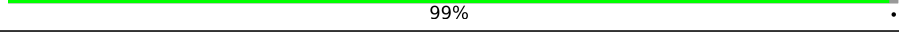
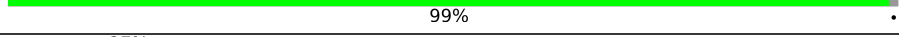
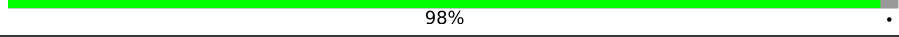
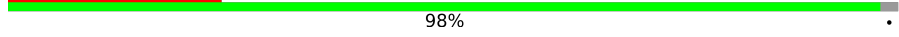

Continued from previous page...

Mol	Chain	Length	Quality of chain
34	W	124	 99%
34	w	124	 99%
35	23	122	 49% 100%
35	78	122	 18% 100%
35	X	122	 100%
35	x	122	 100%
36	24	105	 49% 100%
36	79	105	 58% 100%
36	Y	105	 100%
36	y	105	 100%
37	25	90	 84% 97%
37	80	90	 49% 97%
37	Z	90	 97%
37	z	90	 6% 97%
38	26	688	 21% 98%
38	81	688	 51% 98%
38	C1	688	 98%
38	c1	688	 98%
39	27	604	 35% 99%
39	82	604	 58% 99%
39	C2	604	 99%
39	c2	604	 99%
40	28	594	 27% 98%
40	83	594	 24% 98%
40	C3	594	 98%

Continued on next page...

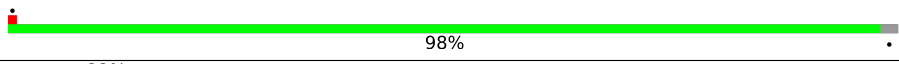

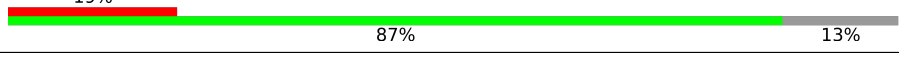
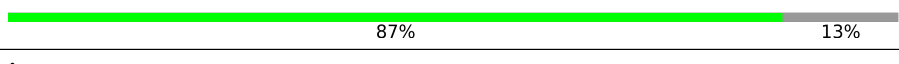
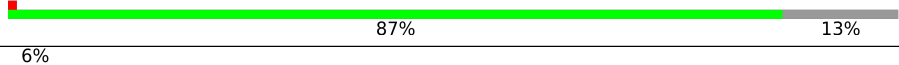
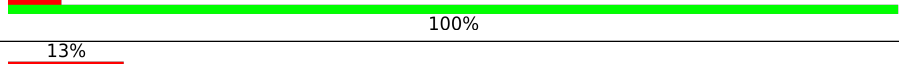
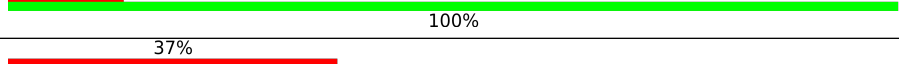
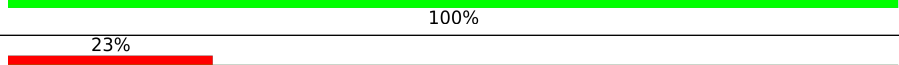
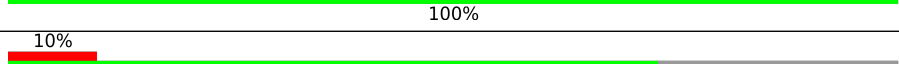
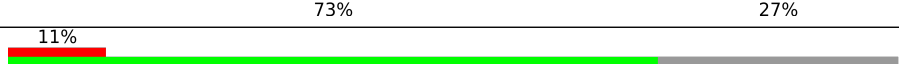
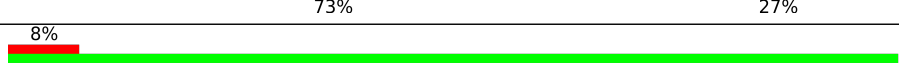
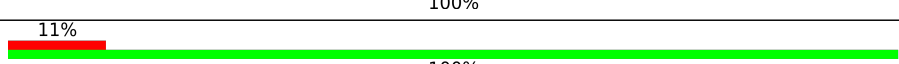
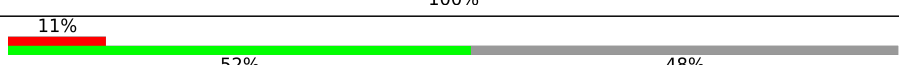
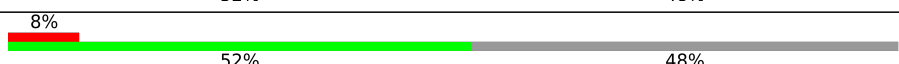
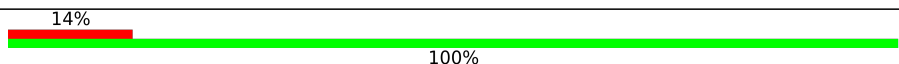
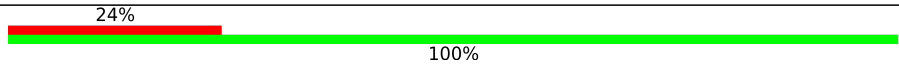
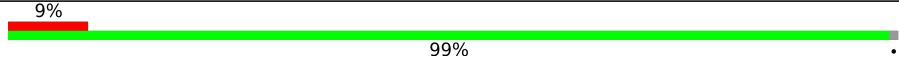
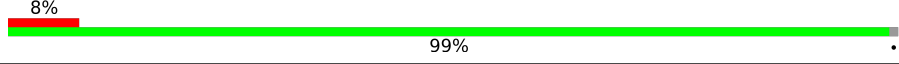
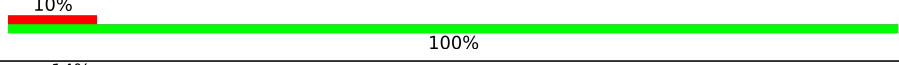
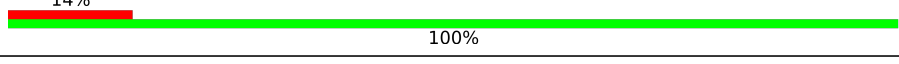
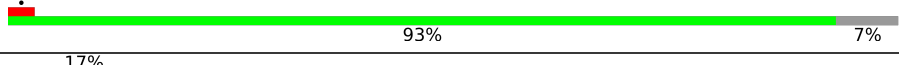
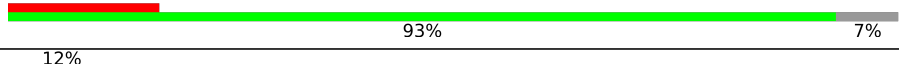
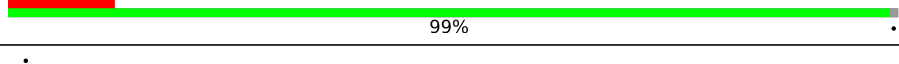
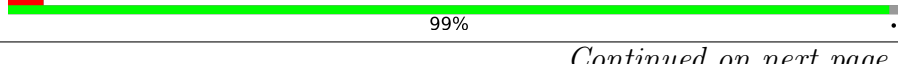
Continued from previous page...

Mol	Chain	Length	Quality of chain
40	c3	594	 98%
41	29	637	 87%
41	84	637	 87%
41	VB	637	 87%
41	vb	637	 87%
42	2B	178	 100%
42	2b	178	 100%
43	2E	322	 100%
43	2e	322	 100%
44	2F	296	 73%
44	2f	296	 73%
45	2G	198	 100%
45	2g	198	 100%
46	2H	195	 52%
46	2h	195	 52%
47	2I	114	 100%
47	2i	114	 100%
48	2J	103	 99%
48	2j	103	 99%
49	2K	93	 100%
49	2k	93	 100%
50	2L	89	 93%
50	2l	89	 93%
51	2M	76	 99%
51	2m	76	 99%











Continued on next page...

Continued from previous page...

Mol	Chain	Length	Quality of chain
52	2N	62	23% 97%
52	2n	62	13% 97%
53	2O	46	13% 91% 9%
53	2o	46	91% 9%
54	30	130	32% 97%
54	6A	130	97%
54	6a	130	97%
54	85	130	20% 97%
55	31	230	42% 97%
55	6B	230	97%
55	6b	230	97%
55	86	230	47% 97%
56	32	103	20% 98%
56	6C	103	98%
56	6c	103	98%
56	87	103	22% 98%
57	33	88	15% 88% 13%
57	6L	88	88% 13%
57	6l	88	88% 13%
57	88	88	27% 88% 13%
58	34	133	32% 100%
58	7A	133	100%
58	7a	133	100%
58	89	133	46% 100%
59	35	236	21% 89% 11%

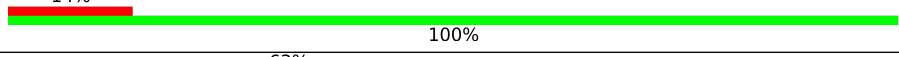
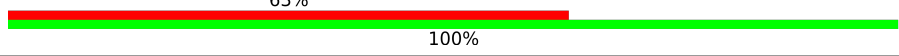
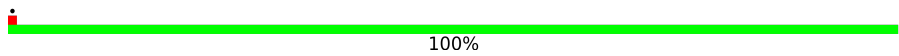
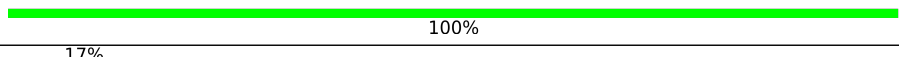
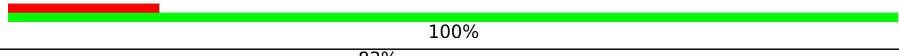
Continued on next page...

Continued from previous page...

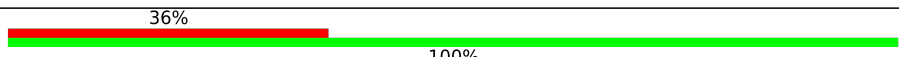
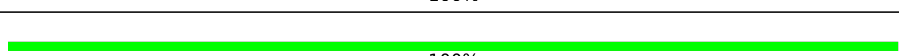
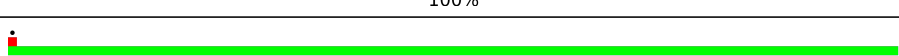
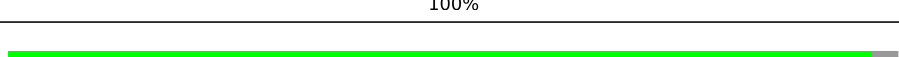
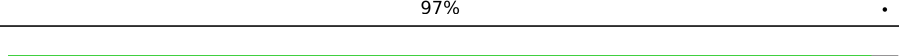
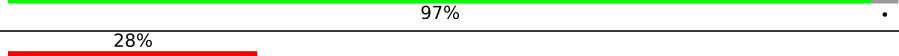
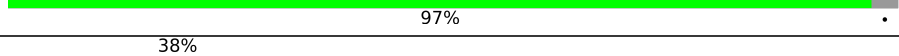
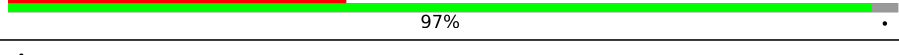
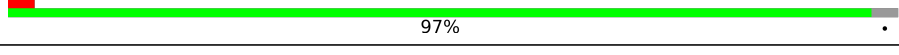
Mol	Chain	Length	Quality of chain
59	7C	236	 89% 11%
59	7c	236	 89% 11%
59	90	236	 58% 89% 11%
60	36	990	 13% 87%
60	7L	990	 13% 87%
60	7I	990	 13% 87%
60	91	990	 10% 13% 87%
61	37	346	 14% 100%
61	92	346	 63% 100%
61	M1	346	 100%
61	m1	346	 100%
62	38	318	 17% 100%
62	93	318	 83% 100%
62	M2	318	 100%
62	m2	318	 100%
63	39	330	 55% 100%
63	94	330	 36% 100%
63	M3	330	 100%
63	m3	330	 100%
64	1T	72	 97% .
64	1t	72	 97% .
64	40	72	 28% 97% .
64	95	72	 38% 97% .
65	2T	72	 97% .
65	2t	72	 97% .









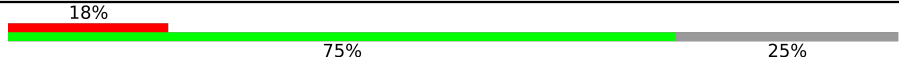
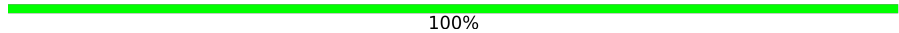
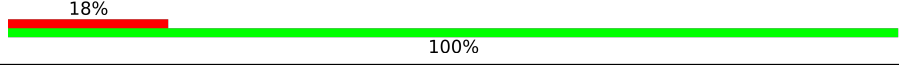
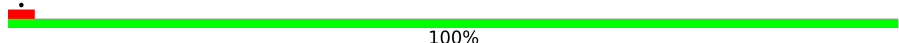
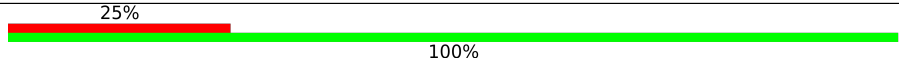

Continued on next page...

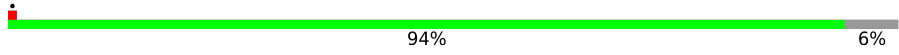
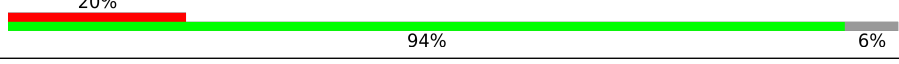
Continued from previous page...

Mol	Chain	Length	Quality of chain
65	41	72	57% 97%
65	96	72	51% 97%
66	3T	93	89% 11%
66	3t	93	89% 11%
66	42	93	48% 89% 11%
66	97	93	42% 89% 11%
67	43	68	21% 84% 16%
67	4T	68	84% 16%
67	4t	68	84% 16%
67	98	68	31% 84% 16%
68	44	81	32% 77% 23%
68	5T	81	77% 23%
68	5t	81	77% 23%
68	99	81	38% 77% 23%
69	4L	116	100%
69	4l	116	9% 100%
70	5B	100	6% 100%
70	5b	100	8% 100%
71	A1	94	99%
71	a1	94	26% 99%
72	A2	103	95% 5%
72	a2	103	37% 95% 5%
73	A3	135	96%
73	a3	135	17% 96%
74	A5	206	75% 25%

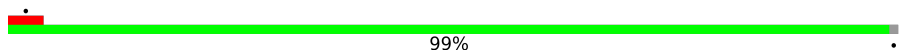
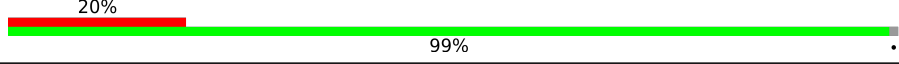
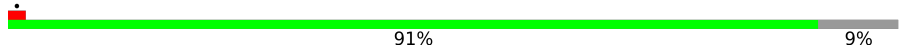
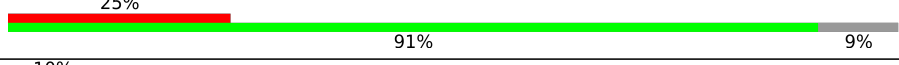
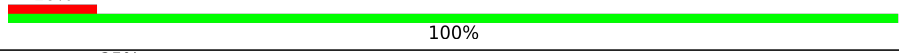
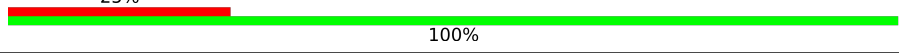
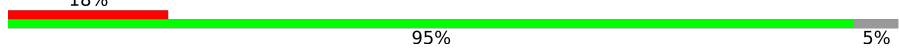
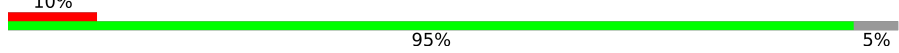
Continued on next page...

Continued from previous page...

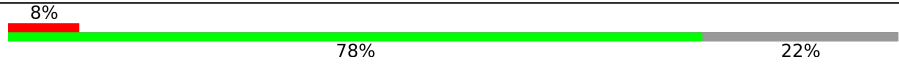
Mol	Chain	Length	Quality of chain
74	a5	206	
75	A6	172	
75	a6	172	
76	A7	282	
76	a7	282	
77	A8	238	
77	a8	238	
78	A9	362	
78	a9	362	
79	AB	138	
79	ab	138	
80	AC	133	
80	ac	133	
81	AL	194	
81	al	194	
82	AM	175	
82	am	175	
83	AN	231	
83	an	231	
84	B2	126	
84	b2	126	
85	B3	83	
85	b3	83	
86	B4	147	
86	b4	147	

Continued on next page...

Continued from previous page...

Mol	Chain	Length	Quality of chain
87	B6	129	5% 54% 46%
87	b6	129	5% 54% 46%
88	B7	120	12% 97%
88	b7	120	7% 97%
89	B8	207	5% 85% 15%
89	b8	207	5% 85% 15%
90	B9	189	5% 99%
90	b9	189	7% 99%
91	BL	188	15% 93% 7%
91	bl	188	12% 93% 7%
92	BM	214	9% 77% 23%
92	bm	214	10% 77% 23%
93	C4	102	9% 100%
93	c4	102	25% 100%
94	FX	172	• 85% 15%
94	fx	172	9% 85% 15%
95	G1	257	89% 11%
95	g1	257	12% 89% 11%
96	G2	233	• 99%
96	g2	233	10% 99%
97	G3	346	• 100%
97	g3	346	10% 100%
98	J1	317	• 84% 16%
98	j1	317	13% 84% 16%
99	N1	284	5% 99%

Continued on next page...

Continued from previous page...

Mol	Chain	Length	Quality of chain
99	n1	284	23% 99%
100	N2	360	100%
100	n2	360	9% 100%
101	N3	121	7% 99%
101	n3	121	21% 99%
102	N4	505	7% 100%
102	n4	505	8% 100%
103	N5	750	9% 95% 5%
103	n5	750	12% 95% 5%
104	N6	255	5% 100%
104	n6	255	21% 100%
105	P1	251	92% 8%
105	p1	251	6% 92% 8%
106	P2	189	88% 12%
106	p2	189	13% 88% 12%
107	QA	482	94% 6%
107	Qa	482	94% 6%
107	qA	482	10% 94% 6%
107	qa	482	9% 94% 6%
108	QB	513	94% 6%
108	Qb	513	11% 94% 6%
108	qB	513	10% 94% 6%
108	qb	513	34% 94% 6%
109	QC	426	5% 100%
109	Qc	426	5% 100%

Continued on next page...

Continued from previous page...

Mol	Chain	Length	Quality of chain
109	qC	426	16% 100%
109	qc	426	12% 100%
110	QD	319	. 92% 8%
110	Qd	319	6% 92% 8%
110	qD	319	10% 92% 8%
110	qd	319	21% 92% 8%
111	QE	269	15% 85% 14%
111	Qe	269	10% 81% 19%
111	qE	269	9% 85% 14%
111	qe	269	25% 81% 19%
112	QF	90	9% 99% .
112	Qf	90	22% 89% 11%
112	qF	90	17% 99% .
112	qf	90	81% 89% 11%
113	QG	328	. 100%
113	Qg	328	. 99% .
113	qG	328	13% 100%
113	qg	328	21% 99% .
114	QH	130	. 99% .
114	Qh	130	8% 99% .
114	qH	130	12% 99% .
114	qh	130	25% 99% .
115	QI	119	. 96% .
115	Qi	119	6% 96% .
115	qI	119	8% 96% .

Continued on next page...



Continued from previous page...

Mol	Chain	Length	Quality of chain
115	qi	119	39% 96%
116	QJ	62	5% 90% 10%
116	Qj	62	15% 94% 6%
116	qJ	62	10% 90% 10%
116	qj	62	18% 94% 6%
117	QL	41	7% 78% 22%
117	Ql	41	5% 78% 22%
117	qL	41	12% 78% 22%
117	ql	41	10% 78% 22%
118	S1	718	6% 96%
118	s1	718	54% 96%
119	S2	442	. 100%
119	s2	442	25% 100%
120	S3	198	. 100%
120	s3	198	25% 100%
121	S4	185	15% 98%
121	s4	185	55% 98%
122	S5	94	12% 99%
122	s5	94	44% 99%
123	S6	132	70% 30%
123	s6	132	31% 70% 30%
124	S7	162	. 99%
124	s7	162	20% 99%
125	S8	236	. 92% 8%
125	s8	236	21% 92% 8%

Continued on next page...

Continued from previous page...

Mol	Chain	Length	Quality of chain
126	SA	636	42% 94% 6%
126	sa	636	83% 94% 6%
127	SB	312	17% 89% 11%
127	sb	312	33% 89% 11%
128	SC	60	15% 97% .
128	sc	60	8% 97% .
129	SD	44	7% 100%
129	sd	44	5% 100%
130	T1	516	. 97% .
130	t1	516	35% 97% .
131	T2	333	11% 83% 16%
131	t2	333	80% 83% 16%
132	T3	311	6% 100%
132	t3	311	25% 100%
133	T4	212	29% 93% 7%
133	t4	212	16% 93% 7%
134	T5	205	13% 69% 31%
134	t5	205	6% 69% 31%
135	T6	144	15% 76% 24%
135	t6	144	31% 76% 24%
136	T7	143	. 99% .
136	t7	143	31% 99% .
137	T8	135	10% 97% .
137	t8	135	19% 97% .
138	T9	136	21% 97% .

Continued on next page...

Continued from previous page...

Mol	Chain	Length	Quality of chain
138	t9	136	33% 97%
139	TA	127	6% 80% 20%
139	ta	127	12% 80% 20%
140	TB	113	5% 85% 15%
140	tb	113	13% 85% 15%
141	TC	93	• 99%
141	tc	93	32% 99%
142	TD	73	• 99%
142	td	73	32% 99%
143	TE	71	• 70% 30%
143	te	71	39% 70% 30%
144	TF	236	• 92% 8%
144	tf	236	58% 92% 8%
145	TG	135	37% 99%
145	tg	135	20% 99%
146	TH	124	8% 100%
146	th	124	17% 100%
147	TX	166	• 87% 13%
147	tx	166	8% 87% 13%
148	V1	474	7% 93% 7%
148	v1	474	91% 93% 7%
149	V2	274	7% 84% 16%
149	v2	274	84% 84% 16%
150	X1	150	26% 99%
150	x1	150	25% 99%

The following table lists non-polymeric compounds, carbohydrate monomers and non-standard residues in protein, DNA, RNA chains that are outliers for geometric or electron-density-fit criteria:

<b>Mol</b>	<b>Type</b>	<b>Chain</b>	<b>Res</b>	<b>Chirality</b>	<b>Geometry</b>	<b>Clashes</b>	<b>Electron density</b>
153	HEA	26	701	X	-	-	-
153	HEA	26	702	X	-	-	-
153	HEA	81	701	X	-	-	-
153	HEA	81	703	X	-	-	-
153	HEA	C1	701	X	-	-	-
153	HEA	C1	702	X	-	-	-
153	HEA	c1	701	X	-	-	-
153	HEA	c1	703	X	-	-	-

## 2 Entry composition [i](#)

There are 164 unique types of molecules in this entry. The entry contains 447736 atoms, of which 0 are hydrogens and 0 are deuteriums.

In the tables below, the AltConf column contains the number of residues with at least one atom in alternate conformation and the Trace column contains the number of residues modelled with at most 2 atoms.

- Molecule 1 is a protein called Transmembrane protein, putative.

Mol	Chain	Residues	Atoms				AltConf	Trace
1	00	449	Total	C	N	O	0	0
			2228	1330	449	449		
1	55	449	Total	C	N	O	0	0
			2228	1330	449	449		
1	a	449	Total	C	N	O	0	0
			2228	1330	449	449		
1	A	449	Total	C	N	O	0	0
			2228	1330	449	449		

- Molecule 2 is a protein called Protein phosphatase 2C, putative.

Mol	Chain	Residues	Atoms				AltConf	Trace
2	01	428	Total	C	N	O	0	0
			2116	1260	428	428		
2	56	428	Total	C	N	O	0	0
			2116	1260	428	428		
2	b	428	Total	C	N	O	0	0
			2116	1260	428	428		
2	B	428	Total	C	N	O	0	0
			2116	1260	428	428		

- Molecule 3 is a protein called COXTT3.

Mol	Chain	Residues	Atoms				AltConf	Trace
3	02	203	Total	C	N	O	0	0
			1003	597	203	203		
3	57	203	Total	C	N	O	0	0
			1003	597	203	203		
3	c	203	Total	C	N	O	0	0
			1003	597	203	203		
3	C	203	Total	C	N	O	0	0
			1003	597	203	203		

- Molecule 4 is a protein called SURF1-like protein.

Mol	Chain	Residues	Atoms				AltConf	Trace
4	03	289	Total	C	N	O	0	0
			1427	849	289	289		
4	58	289	Total	C	N	O	0	0
			1427	849	289	289		
4	d	289	Total	C	N	O	0	0
			1427	849	289	289		
4	D	289	Total	C	N	O	0	0
			1427	849	289	289		

- Molecule 5 is a protein called TraB family protein.

Mol	Chain	Residues	Atoms				AltConf	Trace
5	04	384	Total	C	N	O	0	0
			1905	1137	384	384		
5	59	384	Total	C	N	O	0	0
			1905	1137	384	384		
5	e	384	Total	C	N	O	0	0
			1905	1137	384	384		
5	E	384	Total	C	N	O	0	0
			1905	1137	384	384		

- Molecule 6 is a protein called Transmembrane protein, putative.

Mol	Chain	Residues	Atoms				AltConf	Trace
6	05	243	Total	C	N	O	0	0
			1205	719	243	243		
6	60	243	Total	C	N	O	0	0
			1205	719	243	243		
6	f	243	Total	C	N	O	0	0
			1205	719	243	243		
6	F	243	Total	C	N	O	0	0
			1205	719	243	243		

- Molecule 7 is a protein called NADH dehydrogenase [ubiquinone] 1 alpha subcomplex subunit 8, mitochondrial.

Mol	Chain	Residues	Atoms				AltConf	Trace
7	06	293	Total	C	N	O	0	0
			1454	868	293	293		
7	61	293	Total	C	N	O	0	0
			1454	868	293	293		
7	g	293	Total	C	N	O	0	0
			1454	868	293	293		

*Continued on next page...*

*Continued from previous page...*

Mol	Chain	Residues	Atoms				AltConf	Trace
7	G	293	Total	C	N	O	0	0
			1454	868	293	293		

- Molecule 8 is a protein called SURF1-like protein.

Mol	Chain	Residues	Atoms				AltConf	Trace
8	07	298	Total	C	N	O	0	0
			1469	873	298	298		
8	62	298	Total	C	N	O	0	0
			1469	873	298	298		
8	h	298	Total	C	N	O	0	0
			1469	873	298	298		
8	H	298	Total	C	N	O	0	0
			1469	873	298	298		

- Molecule 9 is a protein called COXTT9.

Mol	Chain	Residues	Atoms				AltConf	Trace
9	08	231	Total	C	N	O	0	0
			1141	679	231	231		
9	63	231	Total	C	N	O	0	0
			1141	679	231	231		
9	i	231	Total	C	N	O	0	0
			1141	679	231	231		
9	I	231	Total	C	N	O	0	0
			1141	679	231	231		

- Molecule 10 is a protein called COXTT10.

Mol	Chain	Residues	Atoms				AltConf	Trace
10	09	187	Total	C	N	O	0	0
			931	557	187	187		
10	64	187	Total	C	N	O	0	0
			931	557	187	187		
10	j	187	Total	C	N	O	0	0
			931	557	187	187		
10	J	187	Total	C	N	O	0	0
			931	557	187	187		

- Molecule 11 is a protein called Annexin.

Mol	Chain	Residues	Atoms				AltConf	Trace
11	0A	70	Total	C	N	O	0	0
			346	206	70	70		
11	45	70	Total	C	N	O	0	0
			346	206	70	70		
11	6t	70	Total	C	N	O	0	0
			346	206	70	70		
11	6T	70	Total	C	N	O	0	0
			346	206	70	70		

- Molecule 12 is a protein called Chromosome condensation regulator RCC1 repeat protein.

Mol	Chain	Residues	Atoms				AltConf	Trace
12	0B	381	Total	C	N	O	0	0
			1858	1096	381	381		
12	46	381	Total	C	N	O	0	0
			1858	1096	381	381		
12	bp	381	Total	C	N	O	0	0
			1858	1096	381	381		
12	BP	381	Total	C	N	O	0	0
			1858	1096	381	381		

- Molecule 13 is a protein called Iron-binding zinc finger CDGSH type protein.

Mol	Chain	Residues	Atoms				AltConf	Trace
13	0C	188	Total	C	N	O	0	0
			928	552	188	188		
13	47	188	Total	C	N	O	0	0
			928	552	188	188		
13	fs	188	Total	C	N	O	0	0
			928	552	188	188		
13	FS	188	Total	C	N	O	0	0
			928	552	188	188		

- Molecule 14 is a protein called Phage protein.

Mol	Chain	Residues	Atoms				AltConf	Trace
14	0D	100	Total	C	N	O	0	0
			494	294	100	100		
14	48	100	Total	C	N	O	0	0
			494	294	100	100		
14	4A	100	Total	C	N	O	0	0
			494	294	100	100		

*Continued on next page...*



*Continued from previous page...*

Mol	Chain	Residues	Atoms			AltConf	Trace	
14	4a	100	Total	C	N	O	0	0
			494	294	100	100		

- Molecule 15 is a protein called Ymf67.

Mol	Chain	Residues	Atoms			AltConf	Trace	
15	0E	343	Total	C	N	O	0	0
			1711	1025	343	343		
15	49	343	Total	C	N	O	0	0
			1711	1025	343	343		
15	y7	343	Total	C	N	O	0	0
			1711	1025	343	343		
15	Y7	343	Total	C	N	O	0	0
			1711	1025	343	343		

- Molecule 16 is a protein called Ymf75.

Mol	Chain	Residues	Atoms			AltConf	Trace	
16	0F	190	Total	C	N	O	0	0
			947	567	190	190		
16	50	190	Total	C	N	O	0	0
			947	567	190	190		
16	y5	190	Total	C	N	O	0	0
			947	567	190	190		
16	Y5	190	Total	C	N	O	0	0
			947	567	190	190		

- Molecule 17 is a protein called Ymf70.

Mol	Chain	Residues	Atoms			AltConf	Trace	
17	0G	89	Total	C	N	O	0	0
			444	266	89	89		
17	51	89	Total	C	N	O	0	0
			444	266	89	89		
17	y0	89	Total	C	N	O	0	0
			444	266	89	89		
17	Y0	89	Total	C	N	O	0	0
			444	266	89	89		

- Molecule 18 is a protein called COXTT28.

Mol	Chain	Residues	Atoms				AltConf	Trace
18	0H	97	Total	C	N	O	0	0
			479	285	97	97		
18	52	97	Total	C	N	O	0	0
			479	285	97	97		
18	z1	97	Total	C	N	O	0	0
			479	285	97	97		
18	Z1	97	Total	C	N	O	0	0
			479	285	97	97		

- Molecule 19 is a protein called Unknown peptide.

Mol	Chain	Residues	Atoms				AltConf	Trace
19	0I	92	Total	C	N	O	0	0
			460	276	92	92		
19	53	92	Total	C	N	O	0	0
			460	276	92	92		
19	u1	92	Total	C	N	O	0	0
			460	276	92	92		
19	U1	92	Total	C	N	O	0	0
			460	276	92	92		

- Molecule 20 is a protein called unknown peptide.

Mol	Chain	Residues	Atoms				AltConf	Trace
20	0J	17	Total	C	N	O	0	0
			85	51	17	17		
20	54	17	Total	C	N	O	0	0
			85	51	17	17		
20	qM	17	Total	C	N	O	0	0
			85	51	17	17		
20	qm	17	Total	C	N	O	0	0
			85	51	17	17		
20	QM	17	Total	C	N	O	0	0
			85	51	17	17		
20	Qm	17	Total	C	N	O	0	0
			85	51	17	17		
20	u2	17	Total	C	N	O	0	0
			85	51	17	17		
20	U2	17	Total	C	N	O	0	0
			85	51	17	17		

- Molecule 21 is a protein called 39S ribosomal protein L9, mitochondrial.

Mol	Chain	Residues	Atoms				AltConf	Trace
21	10	208	Total	C	N	O	0	0
			1032	616	208	208		
21	65	208	Total	C	N	O	0	0
			1032	616	208	208		
21	k	208	Total	C	N	O	0	0
			1032	616	208	208		
21	K	208	Total	C	N	O	0	0
			1032	616	208	208		

- Molecule 22 is a protein called Ubiquinol-cytochrome c reductase complex ubiquinone-binding protein QP-C.

Mol	Chain	Residues	Atoms				AltConf	Trace
22	11	194	Total	C	N	O	0	0
			965	577	194	194		
22	66	194	Total	C	N	O	0	0
			965	577	194	194		
22	l	194	Total	C	N	O	0	0
			965	577	194	194		
22	L	194	Total	C	N	O	0	0
			965	577	194	194		

- Molecule 23 is a protein called Transmembrane protein, putative.

Mol	Chain	Residues	Atoms				AltConf	Trace
23	12	219	Total	C	N	O	0	0
			1083	645	219	219		
23	67	219	Total	C	N	O	0	0
			1083	645	219	219		
23	m	219	Total	C	N	O	0	0
			1083	645	219	219		
23	M	219	Total	C	N	O	0	0
			1083	645	219	219		

- Molecule 24 is a protein called Transmembrane protein, putative.

Mol	Chain	Residues	Atoms				AltConf	Trace
24	13	206	Total	C	N	O	0	0
			1016	604	206	206		
24	68	206	Total	C	N	O	0	0
			1016	604	206	206		
24	n	206	Total	C	N	O	0	0
			1016	604	206	206		

*Continued on next page...*

*Continued from previous page...*

Mol	Chain	Residues	Atoms				AltConf	Trace
24	N	206	Total	C	N	O	0	0
			1016	604	206	206		

- Molecule 25 is a protein called Mobilization protein.

Mol	Chain	Residues	Atoms				AltConf	Trace
25	14	129	Total	C	N	O	0	0
			641	383	129	129		
25	69	129	Total	C	N	O	0	0
			641	383	129	129		
25	o	129	Total	C	N	O	0	0
			641	383	129	129		
25	O	129	Total	C	N	O	0	0
			641	383	129	129		

- Molecule 26 is a protein called YftT domain-containing protein.

Mol	Chain	Residues	Atoms				AltConf	Trace
26	15	175	Total	C	N	O	0	0
			865	515	175	175		
26	70	175	Total	C	N	O	0	0
			865	515	175	175		
26	p	175	Total	C	N	O	0	0
			865	515	175	175		
26	P	175	Total	C	N	O	0	0
			865	515	175	175		

- Molecule 27 is a protein called Transmembrane protein, putative.

Mol	Chain	Residues	Atoms				AltConf	Trace
27	16	173	Total	C	N	O	0	0
			855	509	173	173		
27	71	173	Total	C	N	O	0	0
			855	509	173	173		
27	q	173	Total	C	N	O	0	0
			855	509	173	173		
27	Q	173	Total	C	N	O	0	0
			855	509	173	173		

- Molecule 28 is a protein called Transmembrane protein.

Mol	Chain	Residues	Atoms				AltConf	Trace
28	17	172	Total	C	N	O	0	0
			852	508	172	172		
28	72	172	Total	C	N	O	0	0
			852	508	172	172		
28	r	172	Total	C	N	O	0	0
			852	508	172	172		
28	R	172	Total	C	N	O	0	0
			852	508	172	172		

- Molecule 29 is a protein called Complex III subunit VII.

Mol	Chain	Residues	Atoms				AltConf	Trace
29	18	169	Total	C	N	O	0	0
			841	503	169	169		
29	73	169	Total	C	N	O	0	0
			841	503	169	169		
29	s	169	Total	C	N	O	0	0
			841	503	169	169		
29	S	169	Total	C	N	O	0	0
			841	503	169	169		

- Molecule 30 is a protein called Transmembrane protein, putative.

Mol	Chain	Residues	Atoms				AltConf	Trace
30	19	156	Total	C	N	O	0	0
			771	459	156	156		
30	74	156	Total	C	N	O	0	0
			771	459	156	156		
30	t	156	Total	C	N	O	0	0
			771	459	156	156		
30	T	156	Total	C	N	O	0	0
			771	459	156	156		

- Molecule 31 is a protein called NADH dehydrogenase subunit 1.

Mol	Chain	Residues	Atoms				AltConf	Trace
31	1b	59	Total	C	N	O	0	0
			293	175	59	59		
31	1B	59	Total	C	N	O	0	0
			293	175	59	59		

- Molecule 32 is a protein called Transmembrane protein, putative.

Mol	Chain	Residues	Atoms				AltConf	Trace
32	20	153	Total	C	N	O	0	0
			757	451	153	153		
32	75	153	Total	C	N	O	0	0
			757	451	153	153		
32	u	153	Total	C	N	O	0	0
			757	451	153	153		
32	U	153	Total	C	N	O	0	0
			757	451	153	153		

- Molecule 33 is a protein called COXTT2.

Mol	Chain	Residues	Atoms				AltConf	Trace
33	21	146	Total	C	N	O	0	0
			722	430	146	146		
33	76	146	Total	C	N	O	0	0
			722	430	146	146		
33	v	146	Total	C	N	O	0	0
			722	430	146	146		
33	V	146	Total	C	N	O	0	0
			722	430	146	146		

- Molecule 34 is a protein called Transmembrane protein, putative.

Mol	Chain	Residues	Atoms				AltConf	Trace
34	22	123	Total	C	N	O	0	0
			612	366	123	123		
34	77	123	Total	C	N	O	0	0
			612	366	123	123		
34	w	123	Total	C	N	O	0	0
			612	366	123	123		
34	W	123	Total	C	N	O	0	0
			612	366	123	123		

- Molecule 35 is a protein called Transmembrane protein, putative.

Mol	Chain	Residues	Atoms				AltConf	Trace
35	23	122	Total	C	N	O	0	0
			602	358	122	122		
35	78	122	Total	C	N	O	0	0
			602	358	122	122		
35	x	122	Total	C	N	O	0	0
			602	358	122	122		

*Continued on next page...*

*Continued from previous page...*

Mol	Chain	Residues	Atoms				AltConf	Trace
			Total	C	N	O		
35	X	122	602	358	122	122	0	0

- Molecule 36 is a protein called Lysozyme.

Mol	Chain	Residues	Atoms				AltConf	Trace
			Total	C	N	O		
36	24	105	517	307	105	105	0	0
36	79	105	517	307	105	105	0	0
36	y	105	517	307	105	105	0	0
36	Y	105	517	307	105	105	0	0

- Molecule 37 is a protein called ABC transporter.

Mol	Chain	Residues	Atoms				AltConf	Trace
			Total	C	N	O		
37	25	87	429	255	87	87	0	0
37	80	87	429	255	87	87	0	0
37	z	87	429	255	87	87	0	0
37	Z	87	429	255	87	87	0	0

- Molecule 38 is a protein called Cytochrome c oxidase subunit 1.

Mol	Chain	Residues	Atoms				AltConf	Trace
			Total	C	N	O		
38	26	674	3328	1980	674	674	0	0
38	81	674	3328	1980	674	674	0	0
38	c1	674	3328	1980	674	674	0	0
38	C1	674	3328	1980	674	674	0	0

- Molecule 39 is a protein called Cytochrome c oxidase subunit 2.

Mol	Chain	Residues	Atoms				AltConf	Trace
39	27	599	Total	C	N	O	0	0
			2975	1777	599	599		
39	82	599	Total	C	N	O	0	0
			2975	1777	599	599		
39	c2	599	Total	C	N	O	0	0
			2975	1777	599	599		
39	C2	599	Total	C	N	O	0	0
			2975	1777	599	599		

- Molecule 40 is a protein called Ymf68.

Mol	Chain	Residues	Atoms				AltConf	Trace
40	28	582	Total	C	N	O	0	0
			2894	1730	582	582		
40	83	582	Total	C	N	O	0	0
			2894	1730	582	582		
40	c3	582	Total	C	N	O	0	0
			2894	1730	582	582		
40	C3	582	Total	C	N	O	0	0
			2894	1730	582	582		

- Molecule 41 is a protein called Cytochrome C oxidase subunit Vb protein.

Mol	Chain	Residues	Atoms					AltConf	Trace
41	29	555	Total	C	N	O	P	0	0
			2765	1645	555	563	2		
41	84	555	Total	C	N	O	P	0	0
			2765	1645	555	563	2		
41	vb	555	Total	C	N	O	P	0	0
			2765	1645	555	563	2		
41	VB	555	Total	C	N	O	P	0	0
			2765	1645	555	563	2		

- Molecule 42 is a protein called NADH dehydrogenase subunit 2.

Mol	Chain	Residues	Atoms				AltConf	Trace
42	2b	178	Total	C	N	O	0	0
			884	528	178	178		
42	2B	178	Total	C	N	O	0	0
			884	528	178	178		

- Molecule 43 is a protein called NmrA domain-containing protein.



Mol	Chain	Residues	Atoms				AltConf	Trace
43	2e	321	Total	C	N	O	0	0
			1591	949	321	321		
43	2E	321	Total	C	N	O	0	0
			1591	949	321	321		

- Molecule 44 is a protein called Transmembrane protein, putative.

Mol	Chain	Residues	Atoms				AltConf	Trace
44	2f	217	Total	C	N	O	0	0
			1077	643	217	217		
44	2F	217	Total	C	N	O	0	0
			1077	643	217	217		

- Molecule 45 is a protein called SDHTT3.

Mol	Chain	Residues	Atoms				AltConf	Trace
45	2g	198	Total	C	N	O	0	0
			984	588	198	198		
45	2G	198	Total	C	N	O	0	0
			984	588	198	198		

- Molecule 46 is a protein called Dipthamide synthesis protein.

Mol	Chain	Residues	Atoms				AltConf	Trace
46	2h	102	Total	C	N	O	0	0
			507	303	102	102		
46	2H	102	Total	C	N	O	0	0
			507	303	102	102		

- Molecule 47 is a protein called DUF4885 domain-containing protein.

Mol	Chain	Residues	Atoms				AltConf	Trace
47	2i	114	Total	C	N	O	0	0
			564	336	114	114		
47	2I	114	Total	C	N	O	0	0
			564	336	114	114		

- Molecule 48 is a protein called Transmembrane protein, putative.

Mol	Chain	Residues	Atoms				AltConf	Trace
48	2j	102	Total	C	N	O	0	0
			505	301	102	102		

*Continued on next page...*

*Continued from previous page...*

Mol	Chain	Residues	Atoms				AltConf	Trace
			Total	C	N	O		
48	2J	102	505	301	102	102	0	0

- Molecule 49 is a protein called Transmembrane protein, putative.

Mol	Chain	Residues	Atoms				AltConf	Trace
			Total	C	N	O		
49	2k	93	462	276	93	93	0	0
49	2K	93	462	276	93	93	0	0

- Molecule 50 is a protein called Transposase.

Mol	Chain	Residues	Atoms				AltConf	Trace
			Total	C	N	O		
50	2l	83	415	249	83	83	0	0
50	2L	83	415	249	83	83	0	0

- Molecule 51 is a protein called Transmembrane protein, putative.

Mol	Chain	Residues	Atoms				AltConf	Trace
			Total	C	N	O		
51	2m	75	370	220	75	75	0	0
51	2M	75	370	220	75	75	0	0

- Molecule 52 is a protein called Transmembrane protein, putative.

Mol	Chain	Residues	Atoms				AltConf	Trace
			Total	C	N	O		
52	2n	61	302	180	61	61	0	0
52	2N	61	302	180	61	61	0	0

- Molecule 53 is a protein called SDHTT11.

Mol	Chain	Residues	Atoms				AltConf	Trace
			Total	C	N	O		
53	2o	42	210	126	42	42	0	0
53	2O	42	210	126	42	42	0	0

- Molecule 54 is a protein called Transmembrane protein, putative.

Mol	Chain	Residues	Atoms				AltConf	Trace
			Total	C	N	O		
54	30	126	Total	C	N	O	0	0
			624	372	126	126		
54	85	126	Total	C	N	O	0	0
			624	372	126	126		
54	6a	126	Total	C	N	O	0	0
			624	372	126	126		
54	6A	126	Total	C	N	O	0	0
			624	372	126	126		

- Molecule 55 is a protein called Structural protein.

Mol	Chain	Residues	Atoms				AltConf	Trace
			Total	C	N	O		
55	31	222	Total	C	N	O	0	0
			1101	657	222	222		
55	86	222	Total	C	N	O	0	0
			1101	657	222	222		
55	6b	222	Total	C	N	O	0	0
			1101	657	222	222		
55	6B	222	Total	C	N	O	0	0
			1101	657	222	222		

- Molecule 56 is a protein called Transmembrane protein, putative.

Mol	Chain	Residues	Atoms				AltConf	Trace
			Total	C	N	O		
56	32	101	Total	C	N	O	0	0
			499	297	101	101		
56	87	101	Total	C	N	O	0	0
			499	297	101	101		
56	6c	101	Total	C	N	O	0	0
			499	297	101	101		
56	6C	101	Total	C	N	O	0	0
			499	297	101	101		

- Molecule 57 is a protein called Decapping nuclease.

Mol	Chain	Residues	Atoms				AltConf	Trace
			Total	C	N	O		
57	33	77	Total	C	N	O	0	0
			383	229	77	77		
57	88	77	Total	C	N	O	0	0
			383	229	77	77		
57	6l	77	Total	C	N	O	0	0
			383	229	77	77		

*Continued on next page...*

*Continued from previous page...*

Mol	Chain	Residues	Atoms				AltConf	Trace
			Total	C	N	O		
57	6L	77	383	229	77	77	0	0

- Molecule 58 is a protein called Transmembrane protein, putative.

Mol	Chain	Residues	Atoms				AltConf	Trace
			Total	C	N	O		
58	34	133	659	393	133	133	0	0
58	89	133	659	393	133	133	0	0
58	7a	133	659	393	133	133	0	0
58	7A	133	659	393	133	133	0	0

- Molecule 59 is a protein called NADH dehydrogenase [ubiquinone] 1 beta subcomplex subunit 8, mitochondrial.

Mol	Chain	Residues	Atoms					AltConf	Trace
			Total	C	N	O	P		
59	35	211	1052	625	211	215	1	0	0
59	90	211	1052	625	211	215	1	0	0
59	7c	211	1052	625	211	215	1	0	0
59	7C	211	1052	625	211	215	1	0	0

- Molecule 60 is a protein called CTF/NF-I domain-containing protein.

Mol	Chain	Residues	Atoms				AltConf	Trace
			Total	C	N	O		
60	36	131	654	392	131	131	0	0
60	91	131	654	392	131	131	0	0
60	7l	131	654	392	131	131	0	0
60	7L	131	654	392	131	131	0	0

- Molecule 61 is a protein called Oxoglutarate/malate translocator protein, putative.

Mol	Chain	Residues	Atoms				AltConf	Trace
61	37	346	Total	C	N	O	0	0
			1709	1017	346	346		
61	92	346	Total	C	N	O	0	0
			1709	1017	346	346		
61	m1	346	Total	C	N	O	0	0
			1709	1017	346	346		
61	M1	346	Total	C	N	O	0	0
			1709	1017	346	346		

- Molecule 62 is a protein called 2-oxoglutarate/malate carrier protein.

Mol	Chain	Residues	Atoms				AltConf	Trace
62	38	318	Total	C	N	O	0	0
			1561	925	318	318		
62	93	318	Total	C	N	O	0	0
			1561	925	318	318		
62	m2	318	Total	C	N	O	0	0
			1561	925	318	318		
62	M2	318	Total	C	N	O	0	0
			1561	925	318	318		

- Molecule 63 is a protein called Carrier protein.

Mol	Chain	Residues	Atoms				AltConf	Trace
63	39	329	Total	C	N	O	0	0
			1624	966	329	329		
63	94	329	Total	C	N	O	0	0
			1624	966	329	329		
63	m3	329	Total	C	N	O	0	0
			1624	966	329	329		
63	M3	329	Total	C	N	O	0	0
			1624	966	329	329		

- Molecule 64 is a protein called Tim10/DDP family zinc finger protein.

Mol	Chain	Residues	Atoms				AltConf	Trace
64	40	70	Total	C	N	O	0	0
			349	209	70	70		
64	95	70	Total	C	N	O	0	0
			349	209	70	70		
64	1t	70	Total	C	N	O	0	0
			349	209	70	70		

*Continued on next page...*

*Continued from previous page...*

Mol	Chain	Residues	Atoms				AltConf	Trace
64	1T	70	Total	C	N	O	0	0
			349	209	70	70		

- Molecule 65 is a protein called Zf-Tim10\_DDP domain-containing protein.

Mol	Chain	Residues	Atoms				AltConf	Trace
65	41	70	Total	C	N	O	0	0
			348	208	70	70		
65	96	70	Total	C	N	O	0	0
			348	208	70	70		
65	2T	70	Total	C	N	O	0	0
			348	208	70	70		
65	2t	70	Total	C	N	O	0	0
			348	208	70	70		

- Molecule 66 is a protein called Zf-Tim10\_DDP domain-containing protein.

Mol	Chain	Residues	Atoms				AltConf	Trace
66	42	83	Total	C	N	O	0	0
			413	247	83	83		
66	97	83	Total	C	N	O	0	0
			413	247	83	83		
66	3T	83	Total	C	N	O	0	0
			413	247	83	83		
66	3t	83	Total	C	N	O	0	0
			413	247	83	83		

- Molecule 67 is a protein called Transposase.

Mol	Chain	Residues	Atoms				AltConf	Trace
67	43	57	Total	C	N	O	0	0
			285	171	57	57		
67	98	57	Total	C	N	O	0	0
			285	171	57	57		
67	4T	57	Total	C	N	O	0	0
			285	171	57	57		
67	4t	57	Total	C	N	O	0	0
			285	171	57	57		

- Molecule 68 is a protein called Cullin domain-containing protein.

Mol	Chain	Residues	Atoms				AltConf	Trace
68	44	62	Total	C	N	O	0	0
			309	185	62	62		
68	99	62	Total	C	N	O	0	0
			309	185	62	62		
68	5t	62	Total	C	N	O	0	0
			309	185	62	62		
68	5T	62	Total	C	N	O	0	0
			309	185	62	62		

- Molecule 69 is a protein called Ymf58.

Mol	Chain	Residues	Atoms				AltConf	Trace
69	4l	116	Total	C	N	O	0	0
			576	344	116	116		
69	4L	116	Total	C	N	O	0	0
			576	344	116	116		

- Molecule 70 is a protein called Ymf57.

Mol	Chain	Residues	Atoms				AltConf	Trace
70	5b	100	Total	C	N	O	0	0
			498	298	100	100		
70	5B	100	Total	C	N	O	0	0
			498	298	100	100		

- Molecule 71 is a protein called Transmembrane protein, putative.

Mol	Chain	Residues	Atoms				AltConf	Trace
71	a1	93	Total	C	N	O	0	0
			463	277	93	93		
71	A1	93	Total	C	N	O	0	0
			463	277	93	93		

- Molecule 72 is a protein called Ribosomal protein L51/S25/CI-B8 domain protein.

Mol	Chain	Residues	Atoms				AltConf	Trace
72	a2	98	Total	C	N	O	0	0
			487	291	98	98		
72	A2	98	Total	C	N	O	0	0
			487	291	98	98		

- Molecule 73 is a protein called Transmembrane protein, putative.

Mol	Chain	Residues	Atoms				AltConf	Trace
73	a3	129	Total	C	N	O	0	0
			633	375	129	129		
73	A3	129	Total	C	N	O	0	0
			633	375	129	129		

- Molecule 74 is a protein called ETC complex I subunit motif protein.

Mol	Chain	Residues	Atoms				AltConf	Trace
74	a5	155	Total	C	N	O	0	0
			771	461	155	155		
74	A5	155	Total	C	N	O	0	0
			771	461	155	155		

- Molecule 75 is a protein called NADH dehydrogenase, putative.

Mol	Chain	Residues	Atoms				AltConf	Trace
75	a6	172	Total	C	N	O	0	0
			847	503	172	172		
75	A6	172	Total	C	N	O	0	0
			847	503	172	172		

- Molecule 76 is a protein called 37S ribosomal protein S25, mitochondrial.

Mol	Chain	Residues	Atoms				AltConf	Trace
76	a7	282	Total	C	N	O	0	0
			1404	840	282	282		
76	A7	282	Total	C	N	O	0	0
			1404	840	282	282		

- Molecule 77 is a protein called CX9C domain-containing protein.

Mol	Chain	Residues	Atoms				AltConf	Trace
77	a8	132	Total	C	N	O	0	0
			658	394	132	132		
77	A8	132	Total	C	N	O	0	0
			658	394	132	132		

- Molecule 78 is a protein called NAD-dependent epimerase/dehydratase family protein.

Mol	Chain	Residues	Atoms				AltConf	Trace
78	a9	340	Total	C	N	O	0	0
			1678	998	340	340		

*Continued on next page...*



*Continued from previous page...*

Mol	Chain	Residues	Atoms				AltConf	Trace
			Total	C	N	O		
78	A9	340	1678	998	340	340	0	0

- Molecule 79 is a protein called Acyl carrier protein.

Mol	Chain	Residues	Atoms				AltConf	Trace
			Total	C	N	O		
79	ab	112	557	333	112	112	0	0
79	AB	112	557	333	112	112	0	0

- Molecule 80 is a protein called Acyl carrier protein.

Mol	Chain	Residues	Atoms				AltConf	Trace
			Total	C	N	O		
80	ac	98	488	292	98	98	0	0
80	AC	98	488	292	98	98	0	0

- Molecule 81 is a protein called NADH dehydrogenase [ubiquinone] 1 alpha subcomplex subunit 12.

Mol	Chain	Residues	Atoms				AltConf	Trace
			Total	C	N	O		
81	al	193	949	563	193	193	0	0
81	AL	193	949	563	193	193	0	0

- Molecule 82 is a protein called NDUA13.

Mol	Chain	Residues	Atoms				AltConf	Trace
			Total	C	N	O		
82	am	160	794	474	160	160	0	0
82	AM	160	794	474	160	160	0	0

- Molecule 83 is a protein called Transmembrane protein, putative.

Mol	Chain	Residues	Atoms				AltConf	Trace
			Total	C	N	O		
83	an	231	1135	673	231	231	0	0

*Continued on next page...*

*Continued from previous page...*

Mol	Chain	Residues	Atoms				AltConf	Trace
			Total	C	N	O		
83	AN	231	1135	673	231	231	0	0

- Molecule 84 is a protein called NDUB2.

Mol	Chain	Residues	Atoms				AltConf	Trace
			Total	C	N	O		
84	b2	120	590	350	120	120	0	0
84	B2	120	590	350	120	120	0	0

- Molecule 85 is a protein called Transmembrane protein, putative.

Mol	Chain	Residues	Atoms				AltConf	Trace
			Total	C	N	O		
85	b3	69	342	204	69	69	0	0
85	B3	69	342	204	69	69	0	0

- Molecule 86 is a protein called NDUB4.

Mol	Chain	Residues	Atoms				AltConf	Trace
			Total	C	N	O		
86	b4	115	568	338	115	115	0	0
86	B4	115	568	338	115	115	0	0

- Molecule 87 is a protein called NDUB6.

Mol	Chain	Residues	Atoms				AltConf	Trace
			Total	C	N	O		
87	b6	70	348	208	70	70	0	0
87	B6	70	348	208	70	70	0	0

- Molecule 88 is a protein called CHCH domain-containing protein.

Mol	Chain	Residues	Atoms				AltConf	Trace
			Total	C	N	O		
88	b7	116	572	340	116	116	0	0
88	B7	116	572	340	116	116	0	0

- Molecule 89 is a protein called NDUB8.

Mol	Chain	Residues	Atoms				AltConf	Trace
			Total	C	N	O		
89	b8	175	862	512	175	175	0	0
89	B8	175	862	512	175	175	0	0

- Molecule 90 is a protein called NADH dehydrogenase [ubiquinone] 1 alpha subcomplex subunit 10, mitochondrial.

Mol	Chain	Residues	Atoms				AltConf	Trace
			Total	C	N	O		
90	b9	188	935	559	188	188	0	0
90	B9	188	935	559	188	188	0	0

- Molecule 91 is a protein called NDUB10.

Mol	Chain	Residues	Atoms				AltConf	Trace
			Total	C	N	O		
91	bl	175	869	519	175	175	0	0
91	BL	175	869	519	175	175	0	0

- Molecule 92 is a protein called Transmembrane protein, putative.

Mol	Chain	Residues	Atoms				AltConf	Trace
			Total	C	N	O		
92	bm	164	810	482	164	164	0	0
92	BM	164	810	482	164	164	0	0

- Molecule 93 is a protein called Complex I-MNLL.

Mol	Chain	Residues	Atoms				AltConf	Trace
			Total	C	N	O		
93	c4	102	507	303	102	102	0	0
93	C4	102	507	303	102	102	0	0

- Molecule 94 is a protein called 2 iron, 2 sulfur cluster-binding protein.

Mol	Chain	Residues	Atoms				AltConf	Trace
94	fx	146	Total	C	N	O	0	0
			722	430	146	146		
94	FX	146	Total	C	N	O	0	0
			722	430	146	146		

- Molecule 95 is a protein called Gamma-carbonic anhydrase.

Mol	Chain	Residues	Atoms				AltConf	Trace
95	g1	229	Total	C	N	O	0	0
			1126	668	229	229		
95	G1	229	Total	C	N	O	0	0
			1126	668	229	229		

- Molecule 96 is a protein called Gamma-carbonic anhydrase.

Mol	Chain	Residues	Atoms				AltConf	Trace
96	g2	230	Total	C	N	O	0	0
			1129	669	230	230		
96	G2	230	Total	C	N	O	0	0
			1129	669	230	230		

- Molecule 97 is a protein called Transcription factor apfi protein, putative.

Mol	Chain	Residues	Atoms				AltConf	Trace
97	g3	346	Total	C	N	O	0	0
			1711	1019	346	346		
97	G3	346	Total	C	N	O	0	0
			1711	1019	346	346		

- Molecule 98 is a protein called DnaJ domain protein.

Mol	Chain	Residues	Atoms				AltConf	Trace
98	j1	265	Total	C	N	O	0	0
			1306	776	265	265		
98	J1	265	Total	C	N	O	0	0
			1306	776	265	265		

- Molecule 99 is a protein called NADH-ubiquinone oxidoreductase chain 1.

Mol	Chain	Residues	Atoms				AltConf	Trace
99	n1	283	Total	C	N	O	0	0
			1397	831	283	283		

*Continued on next page...*

*Continued from previous page...*

Mol	Chain	Residues	Atoms				AltConf	Trace
			Total	C	N	O		
99	N1	283	1397	831	283	283	0	0

- Molecule 100 is a protein called Ymf65.

Mol	Chain	Residues	Atoms				AltConf	Trace
			Total	C	N	O		
100	n2	360	1793	1073	360	360	0	0
100	N2	360	1793	1073	360	360	0	0

- Molecule 101 is a protein called NADH-ubiquinone oxidoreductase chain 3.

Mol	Chain	Residues	Atoms				AltConf	Trace
			Total	C	N	O		
101	n3	120	596	356	120	120	0	0
101	N3	120	596	356	120	120	0	0

- Molecule 102 is a protein called NADH-ubiquinone oxidoreductase chain 4.

Mol	Chain	Residues	Atoms				AltConf	Trace
			Total	C	N	O		
102	n4	505	2502	1492	505	505	0	0
102	N4	505	2502	1492	505	505	0	0

- Molecule 103 is a protein called NADH dehydrogenase subunit 5.

Mol	Chain	Residues	Atoms				AltConf	Trace
			Total	C	N	O		
103	n5	709	3517	2099	709	709	0	0
103	N5	709	3517	2099	709	709	0	0

- Molecule 104 is a protein called Ymf62.

Mol	Chain	Residues	Atoms				AltConf	Trace
			Total	C	N	O		
104	n6	255	1269	759	255	255	0	0
104	N6	255	1269	759	255	255	0	0

- Molecule 105 is a protein called Transmembrane protein, putative.

Mol	Chain	Residues	Atoms				AltConf	Trace
			Total	C	N	O		
105	p1	230	1139	679	230	230	0	0
105	P1	230	1139	679	230	230	0	0

- Molecule 106 is a protein called NDUPH2.

Mol	Chain	Residues	Atoms				AltConf	Trace
			Total	C	N	O		
106	p2	167	831	497	167	167	0	0
106	P2	167	831	497	167	167	0	0

- Molecule 107 is a protein called M16 family peptidase, putative.

Mol	Chain	Residues	Atoms				AltConf	Trace
			Total	C	N	O		
107	qA	454	2246	1338	454	454	0	0
107	qa	454	2246	1338	454	454	0	0
107	QA	454	2246	1338	454	454	0	0
107	Qa	454	2246	1338	454	454	0	0

- Molecule 108 is a protein called Peptidase M16 inactive domain protein.

Mol	Chain	Residues	Atoms				AltConf	Trace
			Total	C	N	O		
108	qB	480	2370	1410	480	480	0	0
108	qb	480	2370	1410	480	480	0	0
108	QB	480	2370	1410	480	480	0	0
108	Qb	480	2370	1410	480	480	0	0

- Molecule 109 is a protein called Apocytochrome b.

Mol	Chain	Residues	Atoms				AltConf	Trace
109	qC	426	Total	C	N	O	0	0
			2109	1257	426	426		
109	qc	425	Total	C	N	O	0	0
			2104	1254	425	425		
109	QC	426	Total	C	N	O	0	0
			2109	1257	426	426		
109	Qc	425	Total	C	N	O	0	0
			2104	1254	425	425		

- Molecule 110 is a protein called Cytochrome protein c1.

Mol	Chain	Residues	Atoms				AltConf	Trace
110	qD	295	Total	C	N	O	0	0
			1448	858	295	295		
110	qd	295	Total	C	N	O	0	0
			1448	858	295	295		
110	QD	295	Total	C	N	O	0	0
			1448	858	295	295		
110	Qd	295	Total	C	N	O	0	0
			1448	858	295	295		

- Molecule 111 is a protein called Rieske iron-sulfur protein, ubiquinol-cytochrome C reductase iron-sulfur subunit.

Mol	Chain	Residues	Atoms				AltConf	Trace
111	qE	230	Total	C	N	O	0	0
			1131	671	230	230		
111	qe	219	Total	C	N	O	0	0
			1077	639	219	219		
111	QE	230	Total	C	N	O	0	0
			1131	671	230	230		
111	Qe	219	Total	C	N	O	0	0
			1077	639	219	219		

- Molecule 112 is a protein called Ubiquinol-cytochrome C reductase hinge protein.

Mol	Chain	Residues	Atoms				AltConf	Trace
112	qF	89	Total	C	N	O	0	0
			441	263	89	89		
112	qf	80	Total	C	N	O	0	0
			397	237	80	80		
112	QF	89	Total	C	N	O	0	0
			441	263	89	89		

*Continued on next page...*

*Continued from previous page...*

Mol	Chain	Residues	Atoms				AltConf	Trace
			Total	C	N	O		
112	Qf	80	397	237	80	80	0	0

- Molecule 113 is a protein called Sulphotransf domain-containing protein.

Mol	Chain	Residues	Atoms				AltConf	Trace
			Total	C	N	O		
113	qG	327	1621	967	327	327	0	0
113	qg	326	1616	964	326	326	0	0
113	QG	327	1621	967	327	327	0	0
113	Qg	326	1616	964	326	326	0	0

- Molecule 114 is a protein called Transmembrane protein, putative.

Mol	Chain	Residues	Atoms				AltConf	Trace
			Total	C	N	O		
114	qH	129	635	377	129	129	0	0
114	qh	129	635	377	129	129	0	0
114	QH	129	635	377	129	129	0	0
114	Qh	129	635	377	129	129	0	0

- Molecule 115 is a protein called Transmembrane protein, putative.

Mol	Chain	Residues	Atoms				AltConf	Trace
			Total	C	N	O		
115	qI	114	567	339	114	114	0	0
115	qi	114	567	339	114	114	0	0
115	QI	114	567	339	114	114	0	0
115	Qi	114	567	339	114	114	0	0

- Molecule 116 is a protein called Transmembrane protein, putative.



Mol	Chain	Residues	Atoms				AltConf	Trace
116	qJ	56	Total	C	N	O	0	0
			277	165	56	56		
116	qj	58	Total	C	N	O	0	0
			287	171	58	58		
116	QJ	56	Total	C	N	O	0	0
			277	165	56	56		
116	Qj	58	Total	C	N	O	0	0
			287	171	58	58		

- Molecule 117 is a protein called UQCRTT2.

Mol	Chain	Residues	Atoms				AltConf	Trace
117	qL	32	Total	C	N	O	0	0
			160	96	32	32		
117	ql	32	Total	C	N	O	0	0
			160	96	32	32		
117	QL	32	Total	C	N	O	0	0
			160	96	32	32		
117	Ql	32	Total	C	N	O	0	0
			160	96	32	32		

- Molecule 118 is a protein called NADH-ubiquinone oxidoreductase 75 kDa subunit.

Mol	Chain	Residues	Atoms				AltConf	Trace
118	s1	689	Total	C	N	O	0	0
			3400	2022	689	689		
118	S1	689	Total	C	N	O	0	0
			3400	2022	689	689		

- Molecule 119 is a protein called NADH dehydrogenase subunit 7.

Mol	Chain	Residues	Atoms				AltConf	Trace
119	s2	442	Total	C	N	O	0	0
			2185	1301	442	442		
119	S2	442	Total	C	N	O	0	0
			2185	1301	442	442		

- Molecule 120 is a protein called NADH dehydrogenase subunit 9.

Mol	Chain	Residues	Atoms				AltConf	Trace
120	s3	198	Total	C	N	O	0	0
			988	592	198	198		

*Continued on next page...*

*Continued from previous page...*

Mol	Chain	Residues	Atoms				AltConf	Trace
			Total	C	N	O		
120	S3	198	988	592	198	198	0	0

- Molecule 121 is a protein called NADH dehydrogenase [ubiquinone] iron-sulfur protein 4, mitochondrial.

Mol	Chain	Residues	Atoms				AltConf	Trace
			Total	C	N	O		
121	s4	182	900	536	182	182	0	0
121	S4	182	900	536	182	182	0	0

- Molecule 122 is a protein called GRAM domain protein.

Mol	Chain	Residues	Atoms				AltConf	Trace
			Total	C	N	O		
122	s5	93	462	276	93	93	0	0
122	S5	93	462	276	93	93	0	0

- Molecule 123 is a protein called Zinc-finger protein.

Mol	Chain	Residues	Atoms				AltConf	Trace
			Total	C	N	O		
123	s6	92	455	271	92	92	0	0
123	S6	92	455	271	92	92	0	0

- Molecule 124 is a protein called NADH dehydrogenase subunit 10.

Mol	Chain	Residues	Atoms				AltConf	Trace
			Total	C	N	O		
124	s7	161	792	470	161	161	0	0
124	S7	161	792	470	161	161	0	0

- Molecule 125 is a protein called NADH-ubiquinone oxidoreductase 1, chain, putative.

Mol	Chain	Residues	Atoms				AltConf	Trace
			Total	C	N	O		
125	s8	218	1080	644	218	218	0	0

*Continued on next page...*

*Continued from previous page...*

Mol	Chain	Residues	Atoms				AltConf	Trace
			Total	C	N	O		
125	S8	218	1080	644	218	218	0	0

- Molecule 126 is a protein called Succinate dehydrogenase [ubiquinone] flavoprotein subunit, mitochondrial.

Mol	Chain	Residues	Atoms				AltConf	Trace
			Total	C	N	O		
126	sa	599	2937	1739	599	599	0	0
126	SA	599	2937	1739	599	599	0	0

- Molecule 127 is a protein called Succinate dehydrogenase (quinone).

Mol	Chain	Residues	Atoms				AltConf	Trace
			Total	C	N	O		
127	sb	279	1384	826	279	279	0	0
127	SB	279	1384	826	279	279	0	0

- Molecule 128 is a protein called Cytochrome b-c1 complex subunit 8.

Mol	Chain	Residues	Atoms				AltConf	Trace
			Total	C	N	O		
128	sc	58	286	170	58	58	0	0
128	SC	58	286	170	58	58	0	0

- Molecule 129 is a protein called SDHD.

Mol	Chain	Residues	Atoms				AltConf	Trace
			Total	C	N	O		
129	sd	44	220	132	44	44	0	0
129	SD	44	220	132	44	44	0	0

- Molecule 130 is a protein called Lipid-A-disaccharide synthase.

Mol	Chain	Residues	Atoms				AltConf	Trace
			Total	C	N	O		
130	t1	502	2490	1486	502	502	0	0

*Continued on next page...*

*Continued from previous page...*

Mol	Chain	Residues	Atoms				AltConf	Trace
			Total	C	N	O		
130	T1	502	2490	1486	502	502	0	0

- Molecule 131 is a protein called Acyl-CoA synthetase (AMP-forming)/AMP-acid ligase II.

Mol	Chain	Residues	Atoms				AltConf	Trace
			Total	C	N	O		
131	t2	279	1376	818	279	279	0	0
131	T2	279	1376	818	279	279	0	0

- Molecule 132 is a protein called RNase III domain-containing protein.

Mol	Chain	Residues	Atoms				AltConf	Trace
			Total	C	N	O		
132	t3	310	1541	921	310	310	0	0
132	T3	310	1541	921	310	310	0	0

- Molecule 133 is a protein called Transmembrane protein.

Mol	Chain	Residues	Atoms				AltConf	Trace
			Total	C	N	O		
133	t4	198	981	585	198	198	0	0
133	T4	198	981	585	198	198	0	0

- Molecule 134 is a protein called Transmembrane protein, putative.

Mol	Chain	Residues	Atoms				AltConf	Trace
			Total	C	N	O		
134	t5	141	698	416	141	141	0	0
134	T5	141	698	416	141	141	0	0

- Molecule 135 is a protein called COX assembly mitochondrial protein.

Mol	Chain	Residues	Atoms				AltConf	Trace
			Total	C	N	O		
135	t6	109	542	324	109	109	0	0
135	T6	109	542	324	109	109	0	0

- Molecule 136 is a protein called Transmembrane protein, putative.

Mol	Chain	Residues	Atoms				AltConf	Trace
136	t7	142	Total	C	N	O	0	0
			702	418	142	142		
136	T7	142	Total	C	N	O	0	0
			702	418	142	142		

- Molecule 137 is a protein called PH domain-containing protein.

Mol	Chain	Residues	Atoms				AltConf	Trace
137	t8	131	Total	C	N	O	0	0
			651	389	131	131		
137	T8	131	Total	C	N	O	0	0
			651	389	131	131		

- Molecule 138 is a protein called NADH dehydrogenase [ubiquinone] 1 alpha subcomplex subunit 8.

Mol	Chain	Residues	Atoms				AltConf	Trace
138	t9	132	Total	C	N	O	0	0
			651	387	132	132		
138	T9	132	Total	C	N	O	0	0
			651	387	132	132		

- Molecule 139 is a protein called NADH dehydrogenase [ubiquinone] 1 beta subcomplex subunit 4.

Mol	Chain	Residues	Atoms				AltConf	Trace
139	ta	102	Total	C	N	O	0	0
			504	300	102	102		
139	TA	102	Total	C	N	O	0	0
			504	300	102	102		

- Molecule 140 is a protein called Transmembrane protein, putative.

Mol	Chain	Residues	Atoms				AltConf	Trace
140	tb	96	Total	C	N	O	0	0
			475	283	96	96		
140	TB	96	Total	C	N	O	0	0
			475	283	96	96		

- Molecule 141 is a protein called ATP synthase subunit e, mitochondrial.

Mol	Chain	Residues	Atoms				AltConf	Trace
141	tc	92	Total	C	N	O	0	0
			458	274	92	92		
141	TC	92	Total	C	N	O	0	0
			458	274	92	92		

- Molecule 142 is a protein called Transmembrane protein, putative.

Mol	Chain	Residues	Atoms				AltConf	Trace
142	td	72	Total	C	N	O	0	0
			359	215	72	72		
142	TD	72	Total	C	N	O	0	0
			359	215	72	72		

- Molecule 143 is a protein called Transmembrane protein, putative.

Mol	Chain	Residues	Atoms				AltConf	Trace
143	te	50	Total	C	N	O	0	0
			248	148	50	50		
143	TE	50	Total	C	N	O	0	0
			248	148	50	50		

- Molecule 144 is a protein called NDUTT15.

Mol	Chain	Residues	Atoms				AltConf	Trace
144	tf	216	Total	C	N	O	0	0
			1074	642	216	216		
144	TF	216	Total	C	N	O	0	0
			1074	642	216	216		

- Molecule 145 is a protein called NDUTT16.

Mol	Chain	Residues	Atoms				AltConf	Trace
145	tg	134	Total	C	N	O	0	0
			665	397	134	134		
145	TG	134	Total	C	N	O	0	0
			665	397	134	134		

- Molecule 146 is a protein called NDUTT17.

Mol	Chain	Residues	Atoms				AltConf	Trace
146	th	124	Total	C	N	O	0	0
			611	363	124	124		

*Continued on next page...*

*Continued from previous page...*

Mol	Chain	Residues	Atoms				AltConf	Trace
			Total	C	N	O		
146	TH	124	611	363	124	124	0	0

- Molecule 147 is a protein called Thioredoxin.

Mol	Chain	Residues	Atoms				AltConf	Trace
			Total	C	N	O		
147	tx	144	715	427	144	144	0	0
147	TX	144	715	427	144	144	0	0

- Molecule 148 is a protein called NADH dehydrogenase [ubiquinone] flavoprotein 1, mitochondrial.

Mol	Chain	Residues	Atoms				AltConf	Trace
			Total	C	N	O		
148	v1	442	2163	1279	442	442	0	0
148	V1	442	2163	1279	442	442	0	0

- Molecule 149 is a protein called NADH-ubiquinone oxidoreductase 24 kDa subunit.

Mol	Chain	Residues	Atoms				AltConf	Trace
			Total	C	N	O		
149	v2	231	1144	682	231	231	0	0
149	V2	231	1144	682	231	231	0	0

- Molecule 150 is a protein called NADH-ubiquinone oxidoreductase complex I, 21 kDa subunit.

Mol	Chain	Residues	Atoms				AltConf	Trace
			Total	C	N	O		
150	x1	149	732	434	149	149	0	0
150	X1	149	732	434	149	149	0	0

- Molecule 151 is FE2/S2 (INORGANIC) CLUSTER (three-letter code: FES) (formula: Fe<sub>2</sub>S<sub>2</sub>) (labeled as "Ligand of Interest" by depositor).

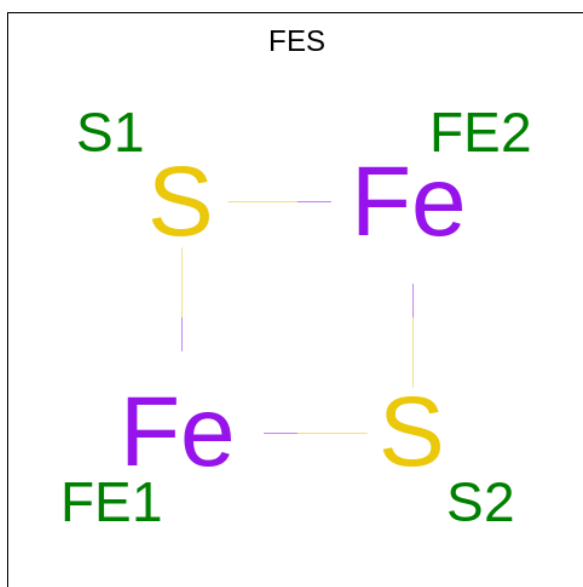

Mol	Chain	Residues	Atoms			AltConf
			Total	Fe	S	
151	0C	1	4	2	2	0
151	0C	1	4	2	2	0
151	47	1	4	2	2	0
151	47	1	4	2	2	0
151	fx	1	4	2	2	0
151	qE	1	4	2	2	0
151	qe	1	4	2	2	0
151	s1	1	4	2	2	0
151	sb	1	4	2	2	0
151	v2	1	4	2	2	0
151	QE	1	4	2	2	0
151	Qe	1	4	2	2	0
151	SB	1	4	2	2	0
151	S1	1	4	2	2	0

*Continued on next page...*



Continued from previous page...

Mol	Chain	Residues	Atoms			AltConf
			Total	Fe	S	
151	V2	1	Total 4	Fe 2	S 2	0
151	FX	1	Total 4	Fe 2	S 2	0
151	fs	1	Total 4	Fe 2	S 2	0
151	fs	1	Total 4	Fe 2	S 2	0
151	FS	1	Total 4	Fe 2	S 2	0
151	FS	1	Total 4	Fe 2	S 2	0

- Molecule 152 is PROTOPORPHYRIN IX CONTAINING FE (three-letter code: HEM) (formula:  $C_{34}H_{32}FeN_4O_4$ ) (labeled as "Ligand of Interest" by depositor).

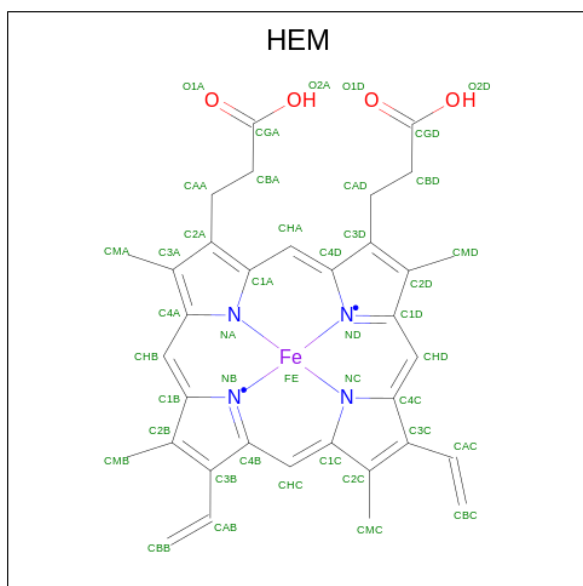

Mol	Chain	Residues	Atoms					AltConf
			Total	C	Fe	N	O	
152	0F	1	Total 43	C 34	Fe 1	N 4	O 4	0
152	50	1	Total 43	C 34	Fe 1	N 4	O 4	0
152	qC	1	Total 43	C 34	Fe 1	N 4	O 4	0
152	qC	1	Total 43	C 34	Fe 1	N 4	O 4	0
152	qc	1	Total 43	C 34	Fe 1	N 4	O 4	0

Continued on next page...

Continued from previous page...

Mol	Chain	Residues	Atoms				AltConf	
			Total	C	Fe	N		O
152	qc	1	Total 43	C 34	Fe 1	N 4	O 4	0
152	QC	1	Total 43	C 34	Fe 1	N 4	O 4	0
152	QC	1	Total 43	C 34	Fe 1	N 4	O 4	0
152	Qc	1	Total 43	C 34	Fe 1	N 4	O 4	0
152	Qc	1	Total 43	C 34	Fe 1	N 4	O 4	0
152	y5	1	Total 43	C 34	Fe 1	N 4	O 4	0
152	Y5	1	Total 43	C 34	Fe 1	N 4	O 4	0

- Molecule 153 is HEME-A (three-letter code: HEA) (formula:  $C_{49}H_{56}FeN_4O_6$ ) (labeled as "Ligand of Interest" by depositor).

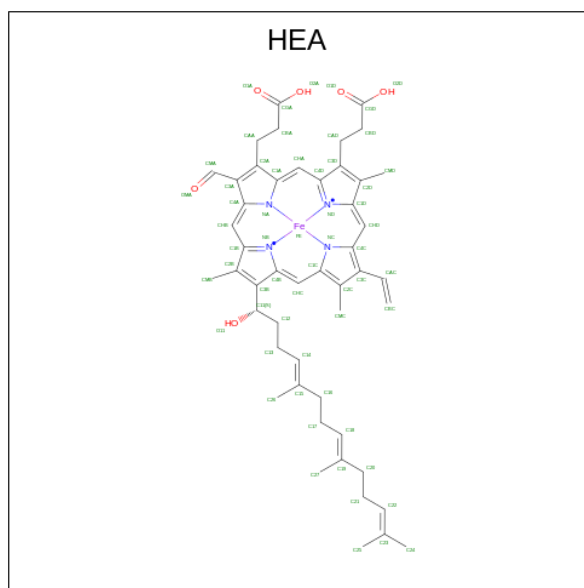

Mol	Chain	Residues	Atoms				AltConf	
			Total	C	Fe	N		O
153	26	1	Total 60	C 49	Fe 1	N 4	O 6	0
153	26	1	Total 60	C 49	Fe 1	N 4	O 6	0
153	81	1	Total 60	C 49	Fe 1	N 4	O 6	0
153	81	1	Total 60	C 49	Fe 1	N 4	O 6	0

Continued on next page...

*Continued from previous page...*

Mol	Chain	Residues	Atoms				AltConf	
153	c1	1	Total	C	Fe	N	O	0
			60	49	1	4	6	
153	c1	1	Total	C	Fe	N	O	0
			60	49	1	4	6	
153	C1	1	Total	C	Fe	N	O	0
			60	49	1	4	6	
153	C1	1	Total	C	Fe	N	O	0
			60	49	1	4	6	

- Molecule 154 is COPPER (II) ION (three-letter code: CU) (formula: Cu).

Mol	Chain	Residues	Atoms		AltConf
154	26	1	Total	Cu	0
			1	1	
154	27	2	Total	Cu	0
			2	2	
154	81	1	Total	Cu	0
			1	1	
154	82	2	Total	Cu	0
			2	2	
154	c1	1	Total	Cu	0
			1	1	
154	c2	2	Total	Cu	0
			2	2	
154	C1	1	Total	Cu	0
			1	1	
154	C2	2	Total	Cu	0
			2	2	

- Molecule 155 is MAGNESIUM ION (three-letter code: MG) (formula: Mg).

Mol	Chain	Residues	Atoms		AltConf
155	26	1	Total	Mg	0
			1	1	
155	81	1	Total	Mg	0
			1	1	
155	c1	1	Total	Mg	0
			1	1	
155	C1	1	Total	Mg	0
			1	1	

- Molecule 156 is ZINC ION (three-letter code: ZN) (formula: Zn).

Mol	Chain	Residues	Atoms		AltConf
156	29	2	Total	Zn	0
			2	2	
156	84	2	Total	Zn	0
			2	2	
156	s6	1	Total	Zn	0
			1	1	
156	S6	1	Total	Zn	0
			1	1	
156	vb	2	Total	Zn	0
			2	2	
156	VB	2	Total	Zn	0
			2	2	

- Molecule 157 is HEME C (three-letter code: HEC) (formula:  $C_{34}H_{34}FeN_4O_4$ ) (labeled as "Ligand of Interest" by depositor).

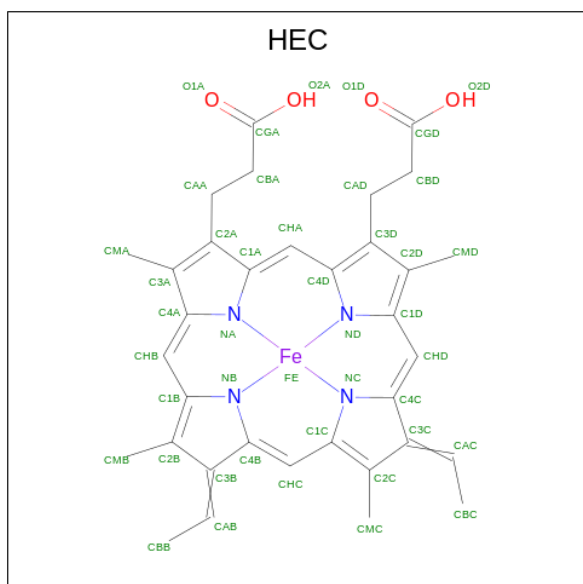

Mol	Chain	Residues	Atoms					AltConf
157	2e	1	Total	C	Fe	N	O	0
			43	34	1	4	4	
157	qD	1	Total	C	Fe	N	O	0
			43	34	1	4	4	
157	qd	1	Total	C	Fe	N	O	0
			43	34	1	4	4	
157	QD	1	Total	C	Fe	N	O	0
			43	34	1	4	4	
157	Qd	1	Total	C	Fe	N	O	0
			43	34	1	4	4	

*Continued on next page...*

Continued from previous page...

Mol	Chain	Residues	Atoms					AltConf
			Total	C	Fe	N	O	
157	2E	1	43	34	1	4	4	0

- Molecule 158 is NADPH DIHYDRO-NICOTINAMIDE-ADENINE-DINUCLEOTIDE PHOSPHATE (three-letter code: NDP) (formula:  $C_{21}H_{30}N_7O_{17}P_3$ ) (labeled as "Ligand of Interest" by depositor).

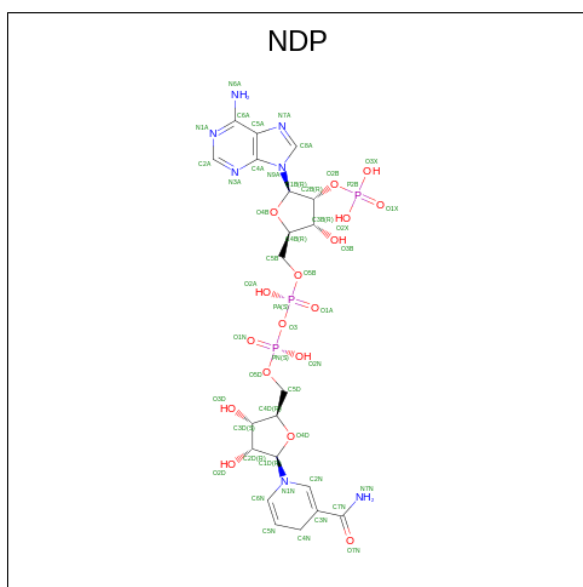

Mol	Chain	Residues	Atoms					AltConf
			Total	C	N	O	P	
158	a9	1	48	21	7	17	3	0
158	A9	1	48	21	7	17	3	0

- Molecule 159 is ADENOSINE-5'-DIPHOSPHATE (three-letter code: ADP) (formula:  $C_{10}H_{15}N_5O_{10}P_2$ ).



Mol	Chain	Residues	Atoms				AltConf	
159	b8	1	Total	C	N	O	P	0
			27	10	5	10	2	
159	B8	1	Total	C	N	O	P	0
			27	10	5	10	2	

- Molecule 160 is UBIQUINONE-10 (three-letter code: U10) (formula: C<sub>59</sub>H<sub>90</sub>O<sub>4</sub>) (labeled as "Ligand of Interest" by depositor).

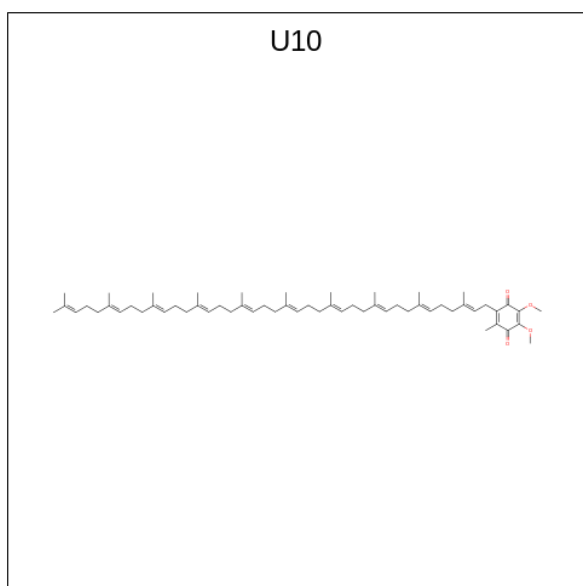

Mol	Chain	Residues	Atoms		AltConf
160	qc	1	Total	C	0
			26	26	

*Continued on next page...*

Continued from previous page...

Mol	Chain	Residues	Atoms	AltConf
160	Qc	1	Total C 26 26	0

- Molecule 161 is IRON/SULFUR CLUSTER (three-letter code: SF4) (formula: Fe<sub>4</sub>S<sub>4</sub>) (labeled as "Ligand of Interest" by depositor).

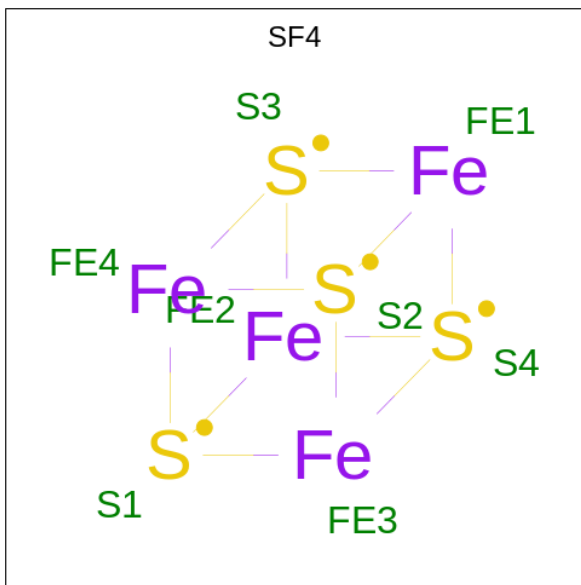

Mol	Chain	Residues	Atoms	AltConf
161	s1	1	Total Fe S 8 4 4	0
161	s1	1	Total Fe S 8 4 4	0
161	s7	1	Total Fe S 8 4 4	0
161	s8	1	Total Fe S 8 4 4	0
161	s8	1	Total Fe S 8 4 4	0
161	sb	1	Total Fe S 8 4 4	0
161	v1	1	Total Fe S 8 4 4	0
161	SB	1	Total Fe S 8 4 4	0
161	S1	1	Total Fe S 8 4 4	0
161	S1	1	Total Fe S 8 4 4	0

Continued on next page...

Continued from previous page...

Mol	Chain	Residues	Atoms			AltConf
			Total	Fe	S	
161	S7	1	8	4	4	0
161	S8	1	8	4	4	0
161	S8	1	8	4	4	0
161	V1	1	8	4	4	0

- Molecule 162 is FLAVIN-ADENINE DINUCLEOTIDE (three-letter code: FAD) (formula:  $C_{27}H_{33}N_9O_{15}P_2$ ) (labeled as "Ligand of Interest" by depositor).

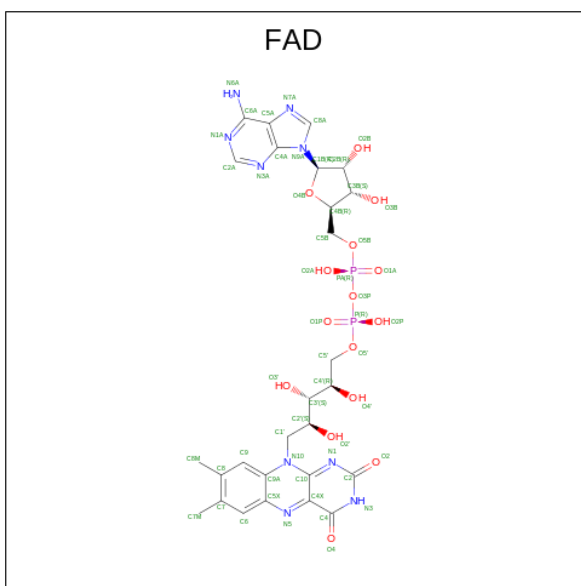

Mol	Chain	Residues	Atoms					AltConf
			Total	C	N	O	P	
162	sa	1	53	27	9	15	2	0
162	SA	1	53	27	9	15	2	0

- Molecule 163 is FE3-S4 CLUSTER (three-letter code: F3S) (formula:  $Fe_3S_4$ ) (labeled as "Ligand of Interest" by depositor).



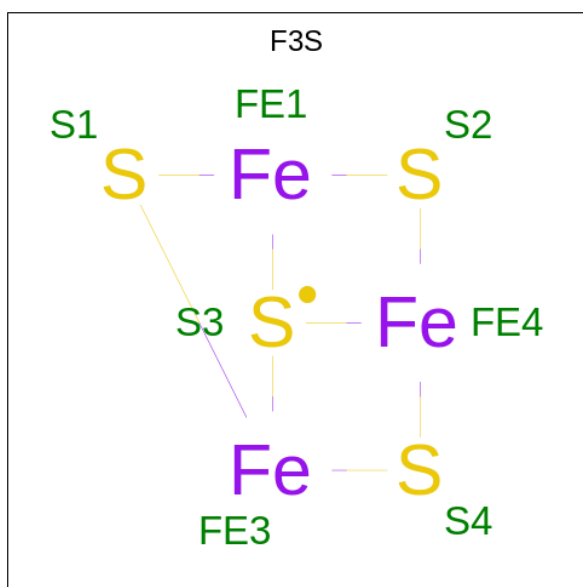

Mol	Chain	Residues	Atoms			AltConf
163	sb	1	Total	Fe	S	0
			7	3	4	
163	SB	1	Total	Fe	S	0
			7	3	4	

- Molecule 164 is FLAVIN MONONUCLEOTIDE (three-letter code: FMN) (formula: C<sub>17</sub>H<sub>21</sub>N<sub>4</sub>O<sub>9</sub>P) (labeled as "Ligand of Interest" by depositor).

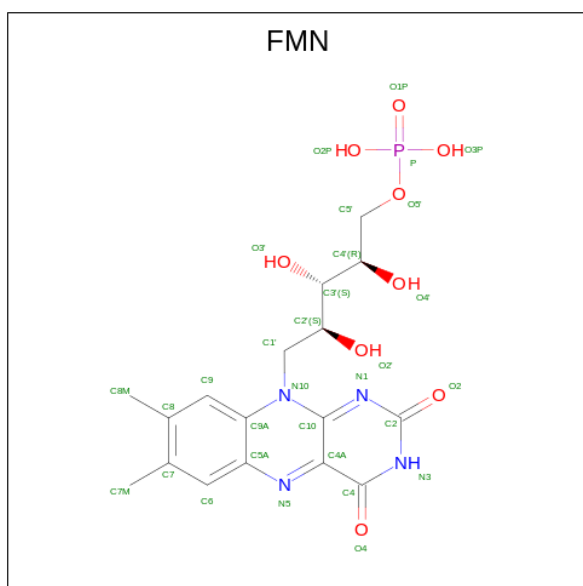

Mol	Chain	Residues	Atoms				AltConf	
164	v1	1	Total	C	N	O	P	0
			31	17	4	9	1	

*Continued on next page...*

*Continued from previous page...*

Mol	Chain	Residues	Atoms					AltConf
			Total	C	N	O	P	
164	V1	1	31	17	4	9	1	0

### 3 Residue-property plots [i](#)

These plots are drawn for all protein, RNA, DNA and oligosaccharide chains in the entry. The first graphic for a chain summarises the proportions of the various outlier classes displayed in the second graphic. The second graphic shows the sequence view annotated by issues in geometry and atom inclusion in map density. Residues are color-coded according to the number of geometric quality criteria for which they contain at least one outlier: green = 0, yellow = 1, orange = 2 and red = 3 or more. A red diamond above a residue indicates a poor fit to the EM map for this residue (all-atom inclusion < 40%). Stretches of 2 or more consecutive residues without any outlier are shown as a green connector. Residues present in the sample, but not in the model, are shown in grey.

- Molecule 1: Transmembrane protein, putative

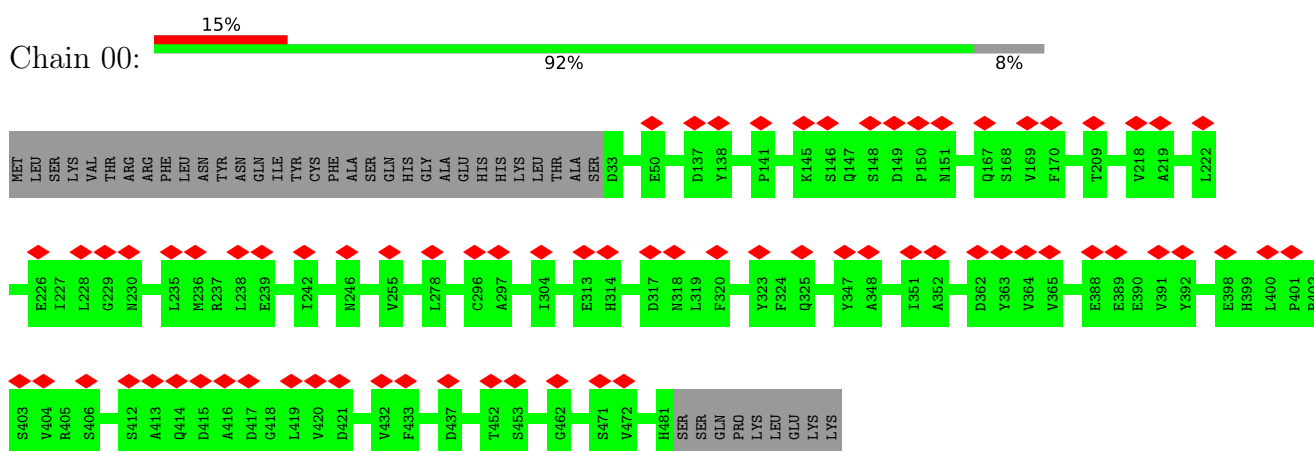

- Molecule 1: Transmembrane protein, putative

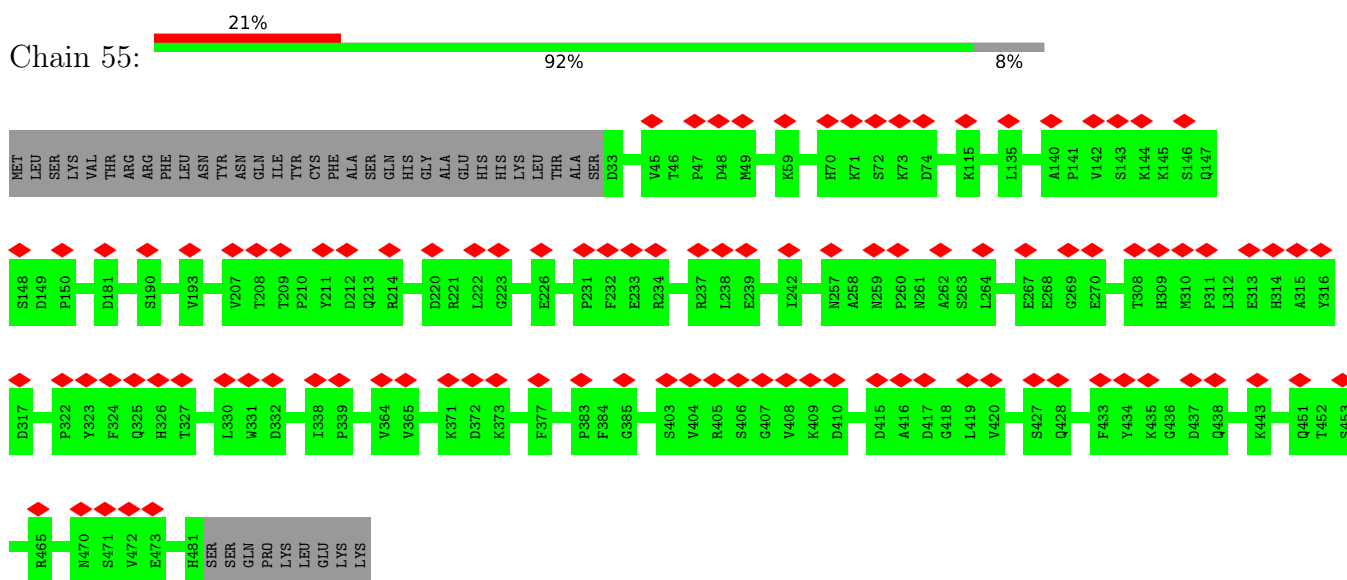

- Molecule 1: Transmembrane protein, putative



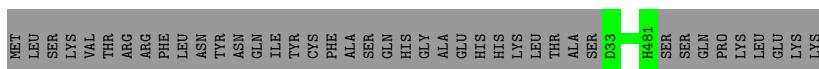

- Molecule 1: Transmembrane protein, putative

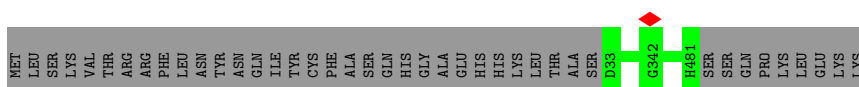

- Molecule 2: Protein phosphatase 2C, putative



- Molecule 2: Protein phosphatase 2C, putative

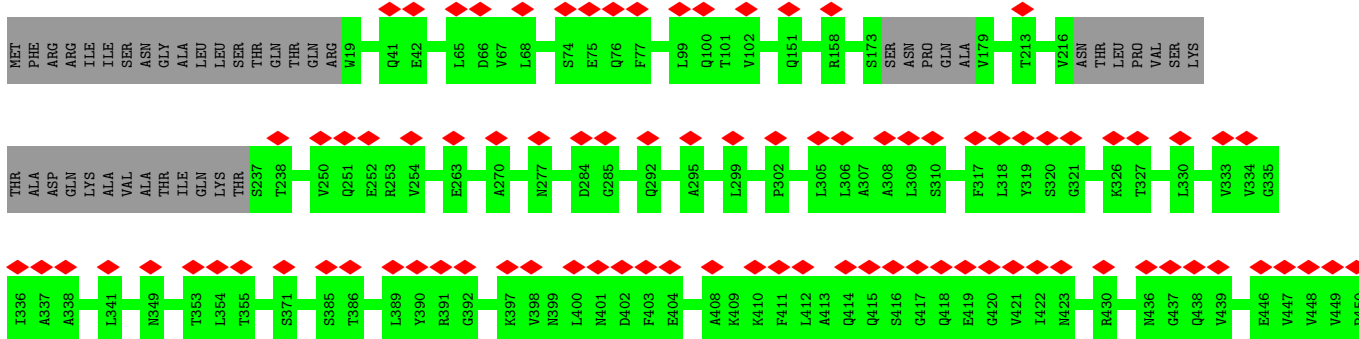
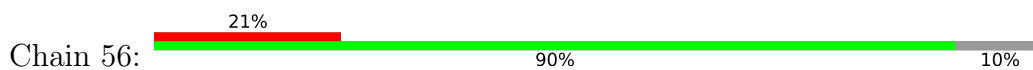

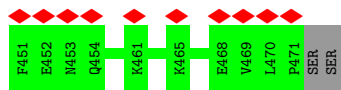

• Molecule 2: Protein phosphatase 2C, putative

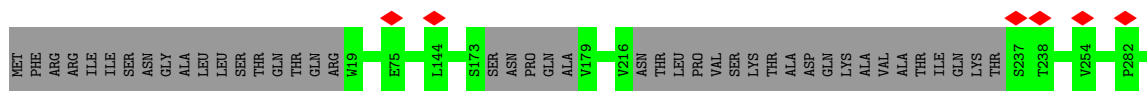

• Molecule 2: Protein phosphatase 2C, putative

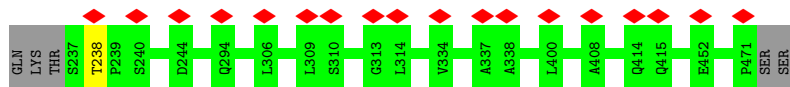
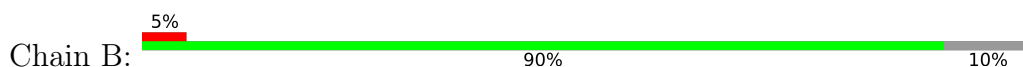

• Molecule 3: COXTT3

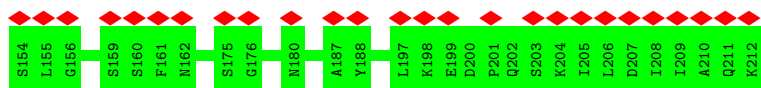
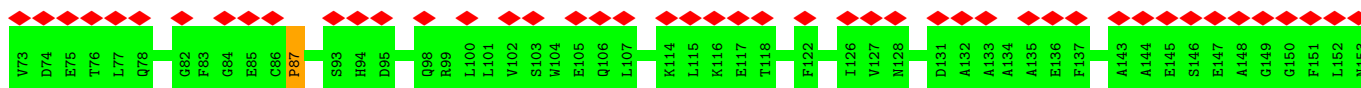
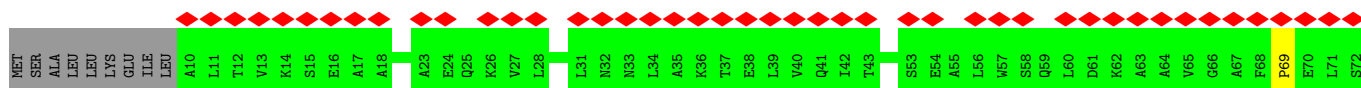

• Molecule 3: COXTT3

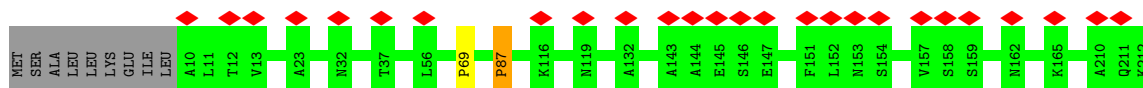

• Molecule 3: COXTT3



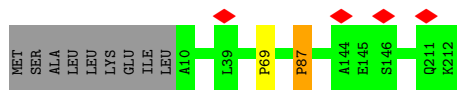

• Molecule 3: COXTT3

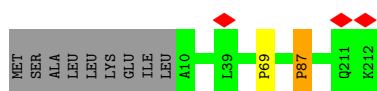

• Molecule 4: SURF1-like protein

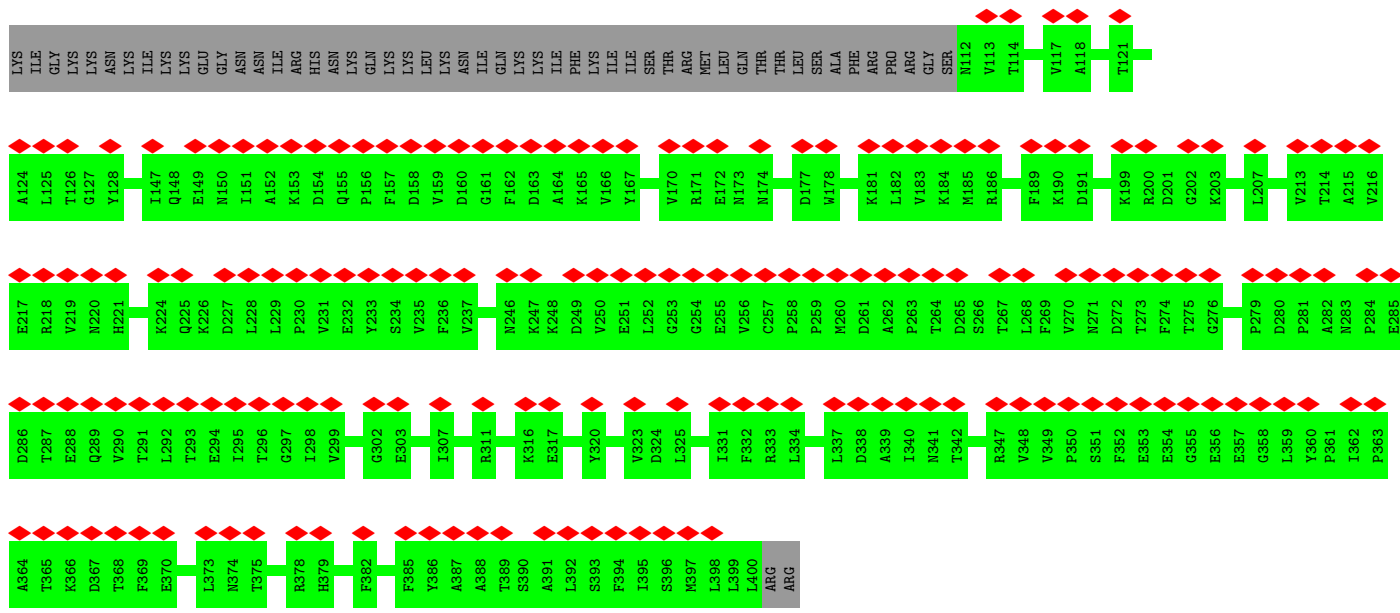
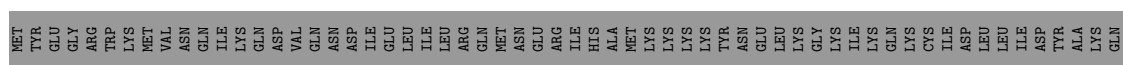
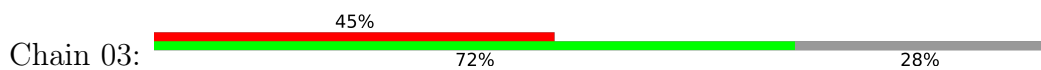

• Molecule 4: SURF1-like protein

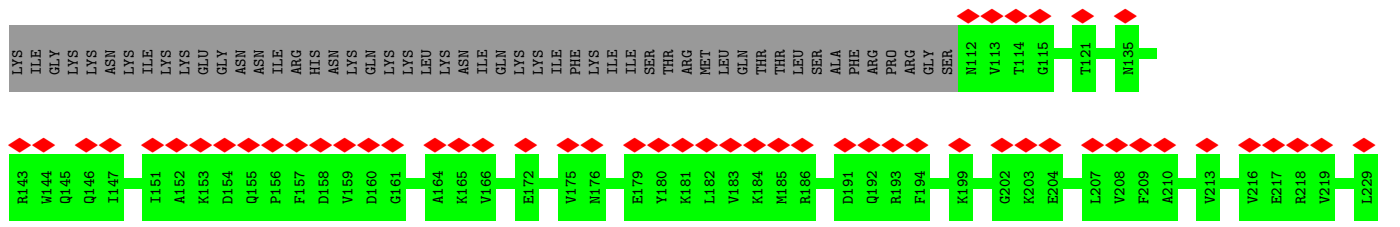
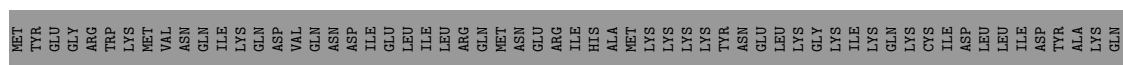
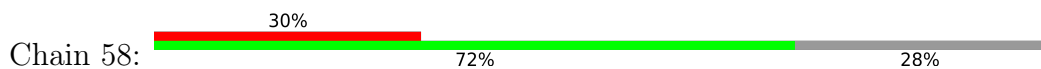



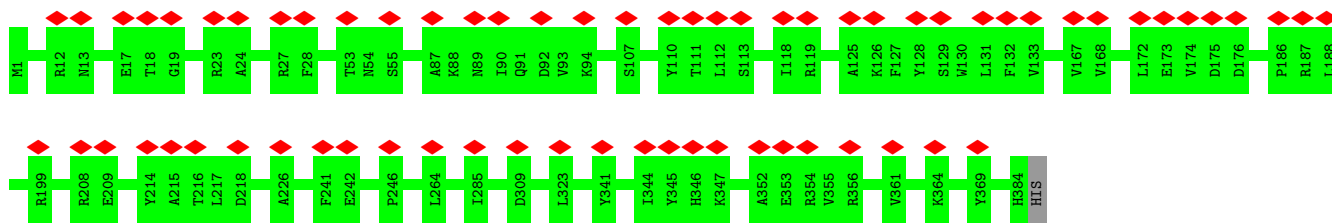

• Molecule 5: TraB family protein

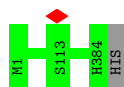

• Molecule 5: TraB family protein



• Molecule 6: Transmembrane protein, putative

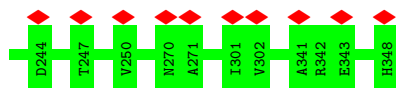
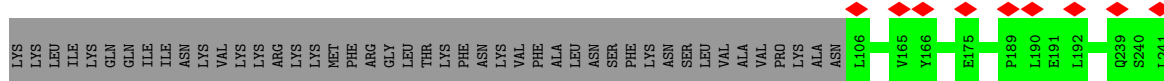
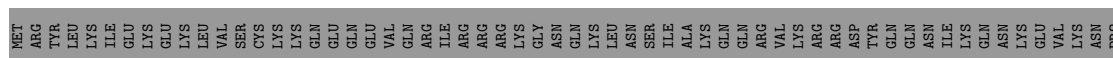

• Molecule 6: Transmembrane protein, putative

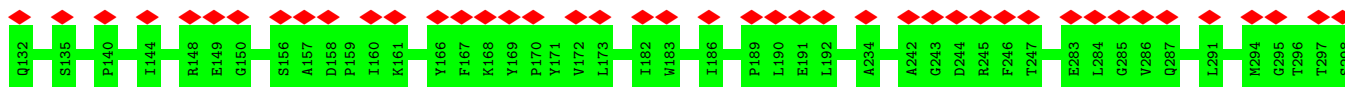
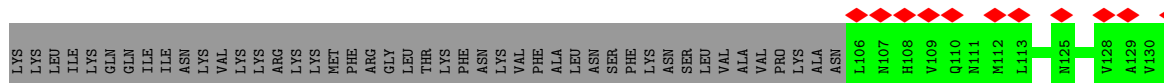



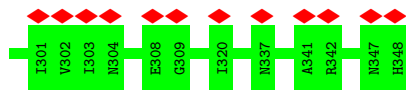

• Molecule 6: Transmembrane protein, putative

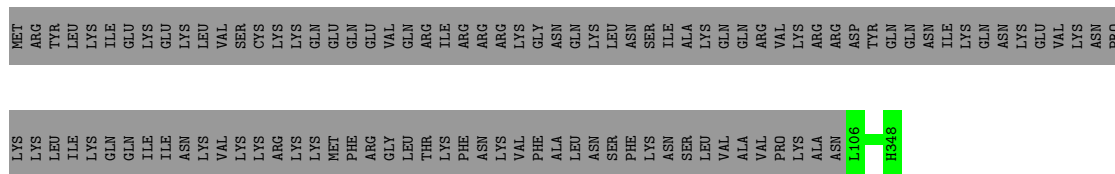

• Molecule 6: Transmembrane protein, putative

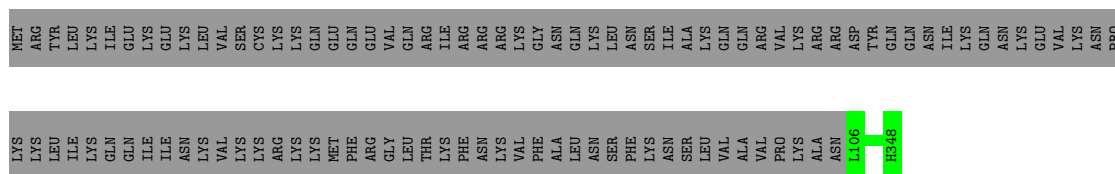

• Molecule 7: NADH dehydrogenase [ubiquinone] 1 alpha subcomplex subunit 8, mitochondrial

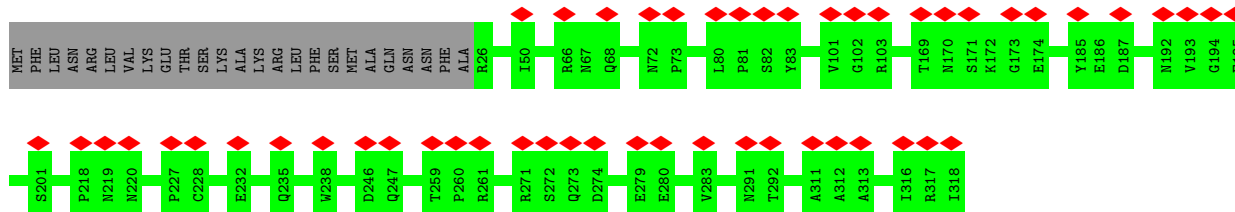
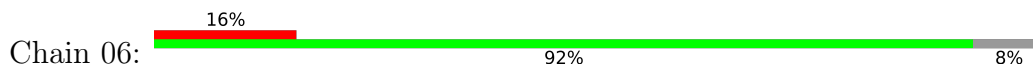

• Molecule 7: NADH dehydrogenase [ubiquinone] 1 alpha subcomplex subunit 8, mitochondrial

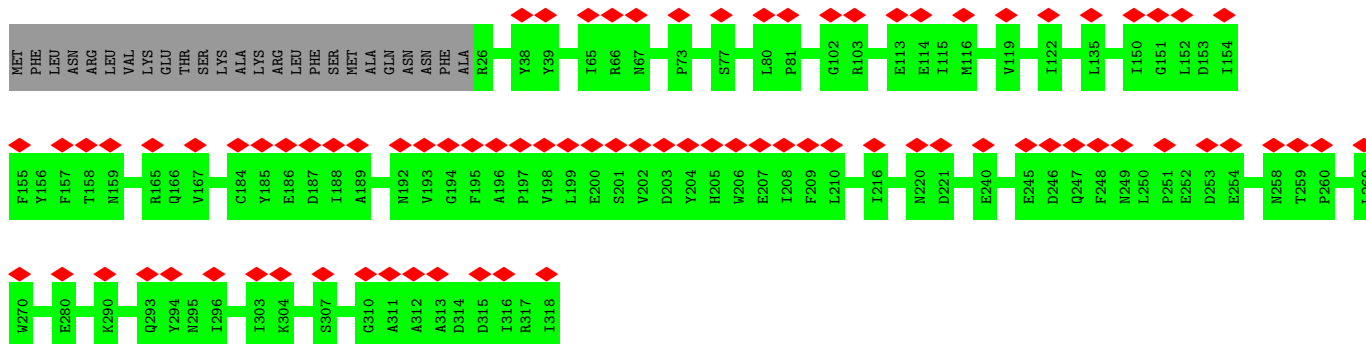

- Molecule 7: NADH dehydrogenase [ubiquinone] 1 alpha subcomplex subunit 8, mitochondrial

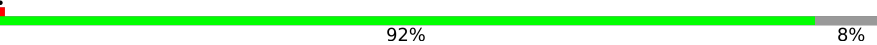
Chain g:  92% 8%

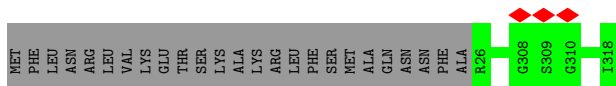

- Molecule 7: NADH dehydrogenase [ubiquinone] 1 alpha subcomplex subunit 8, mitochondrial

Chain G:  92% 8%

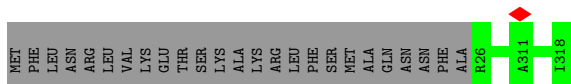

- Molecule 8: SURF1-like protein

Chain 07:  19% 94% 6%

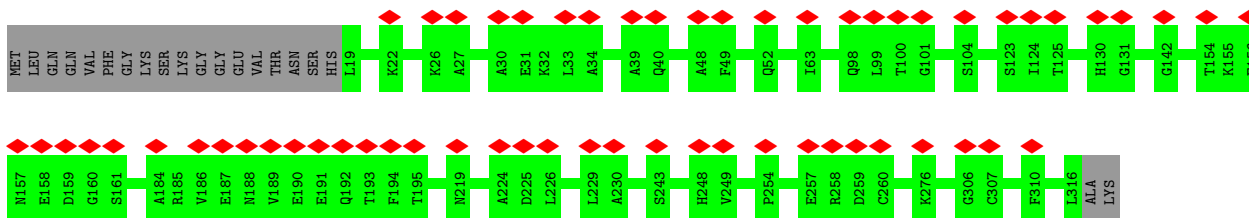

- Molecule 8: SURF1-like protein

Chain 62:  69% 94% 6%



- Molecule 8: SURF1-like protein

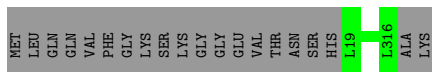

- Molecule 8: SURF1-like protein

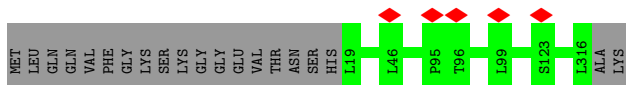

- Molecule 9: COXTT9

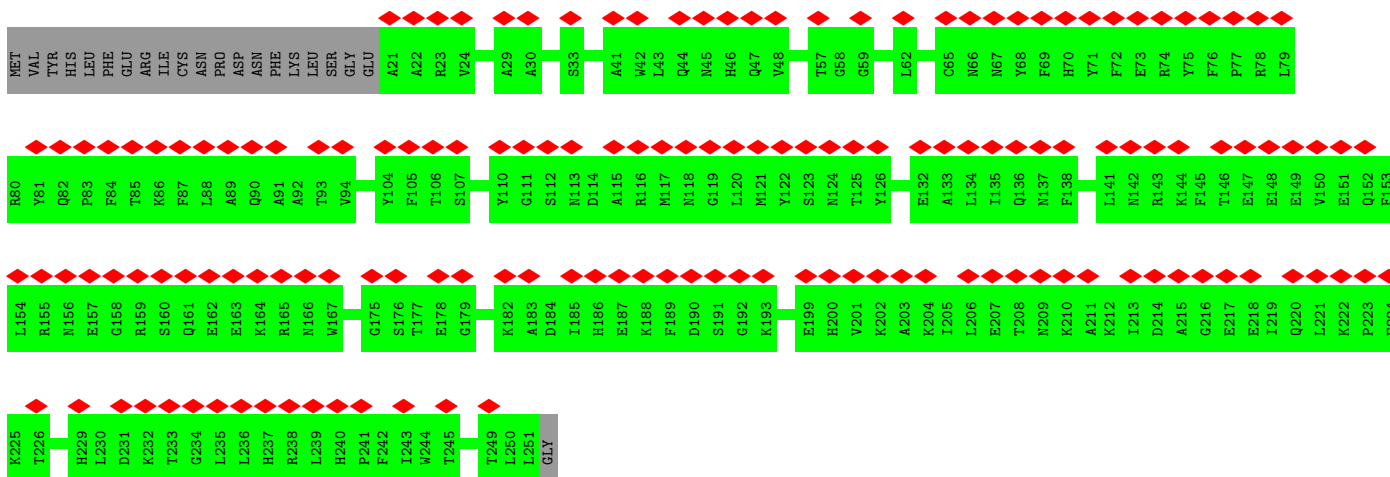

- Molecule 9: COXTT9

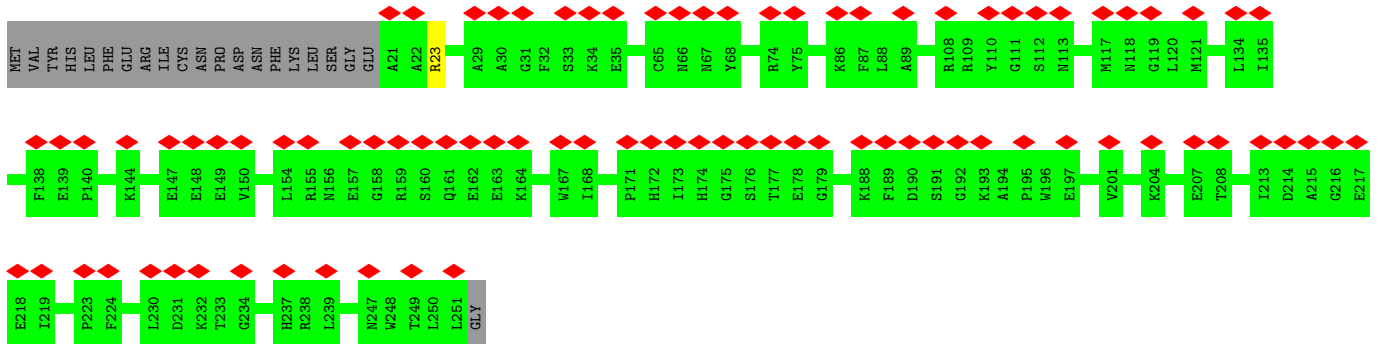

- Molecule 9: COXTT9

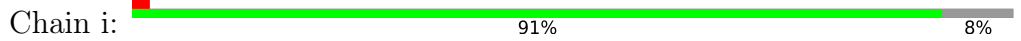

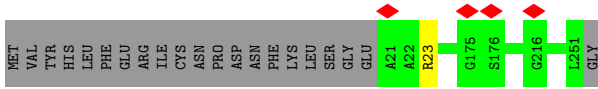

• Molecule 9: COXTT9

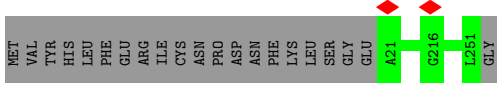
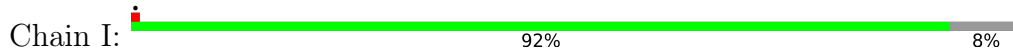

• Molecule 10: COXTT10

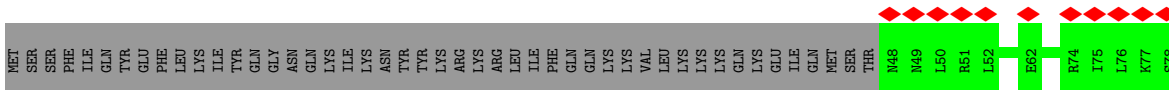
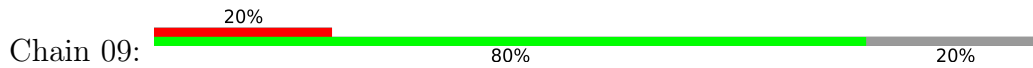

• Molecule 10: COXTT10

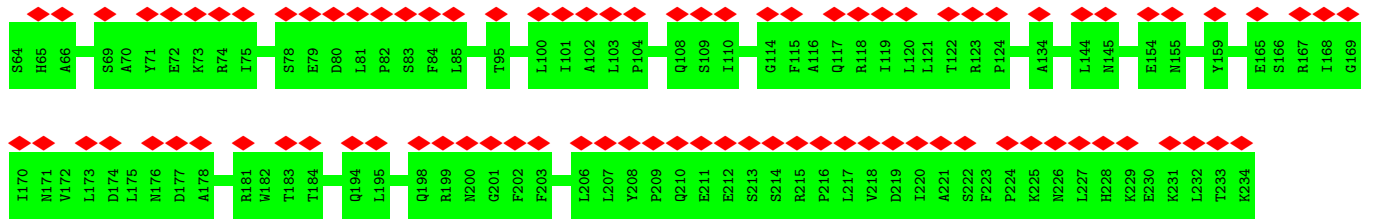
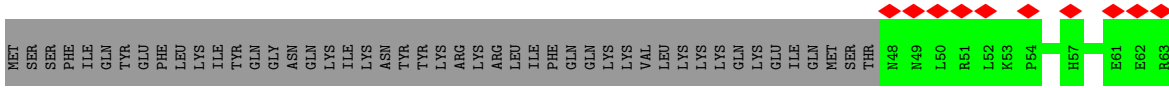
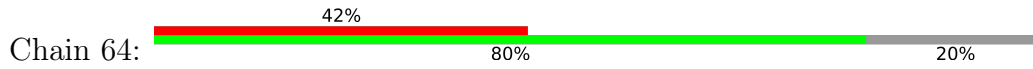

• Molecule 10: COXTT10

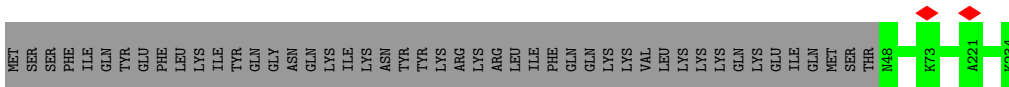
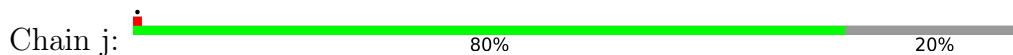

• Molecule 10: COXTT10

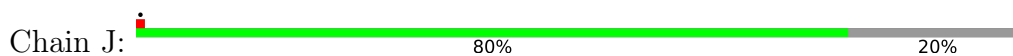

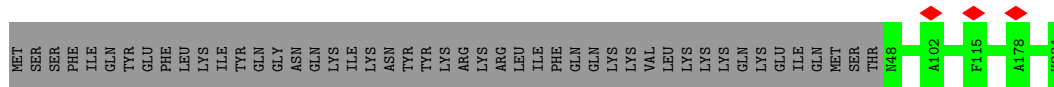

• Molecule 11: Annexin

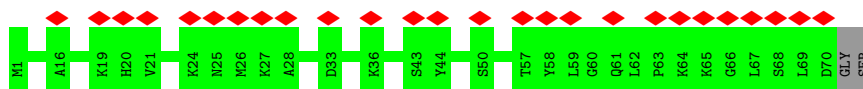

• Molecule 11: Annexin

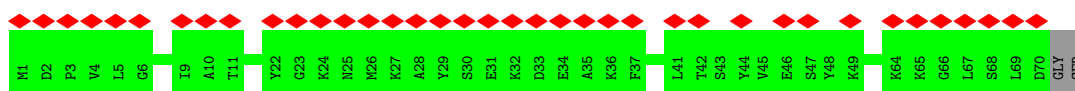

• Molecule 11: Annexin

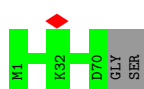

• Molecule 11: Annexin

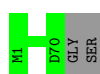

• Molecule 12: Chromosome condensation regulator RCC1 repeat protein

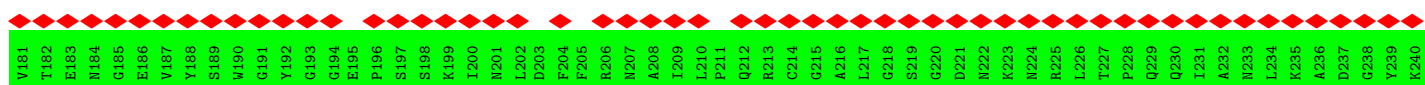
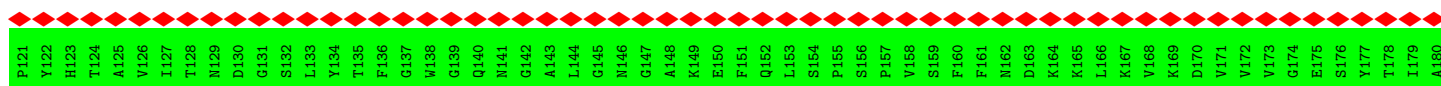
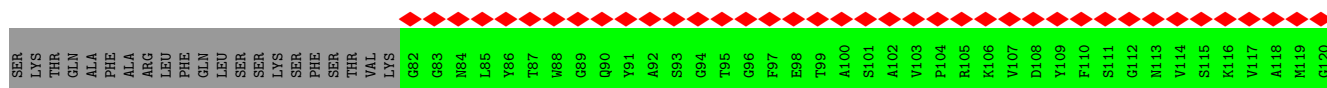
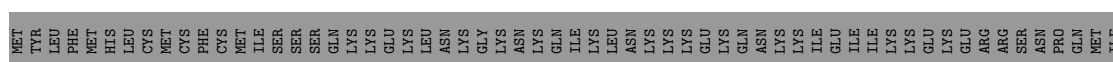
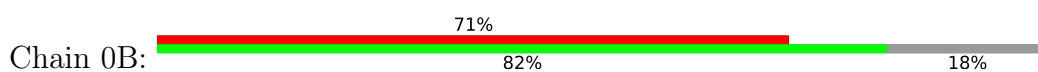

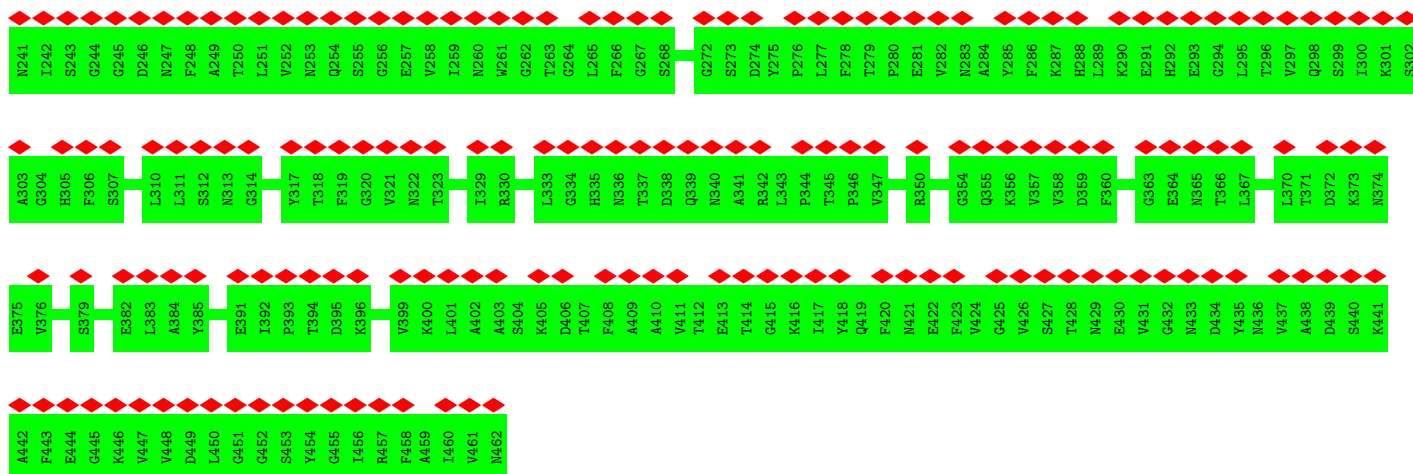

• Molecule 12: Chromosome condensation regulator RCC1 repeat protein

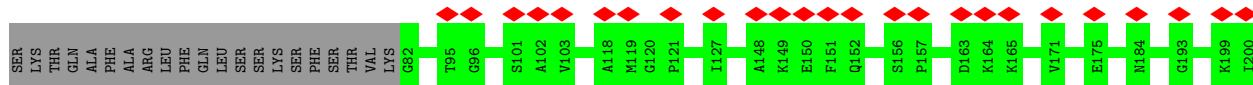
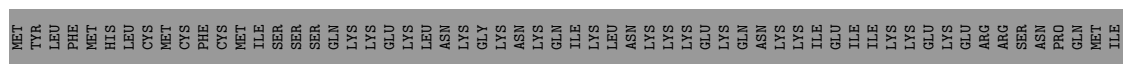
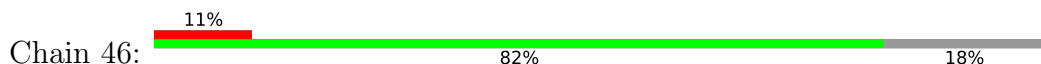

• Molecule 12: Chromosome condensation regulator RCC1 repeat protein

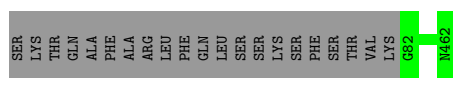
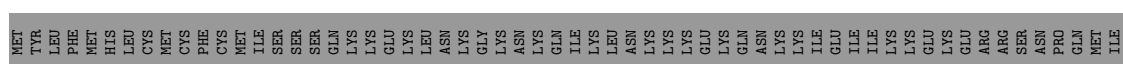
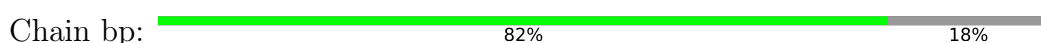

• Molecule 12: Chromosome condensation regulator RCC1 repeat protein

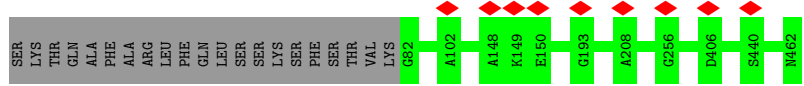
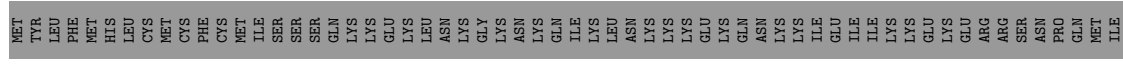
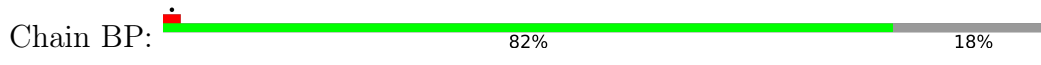

• Molecule 13: Iron-binding zinc finger CDGSH type protein

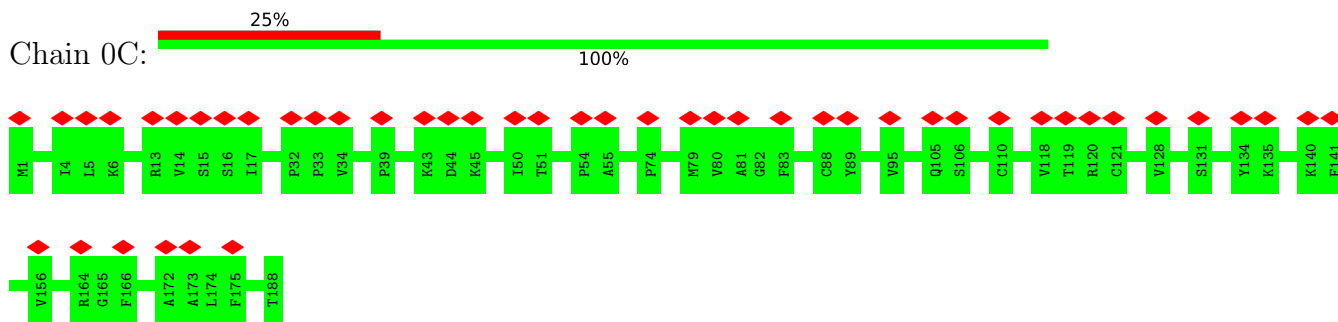

- Molecule 13: Iron-binding zinc finger CDGSH type protein

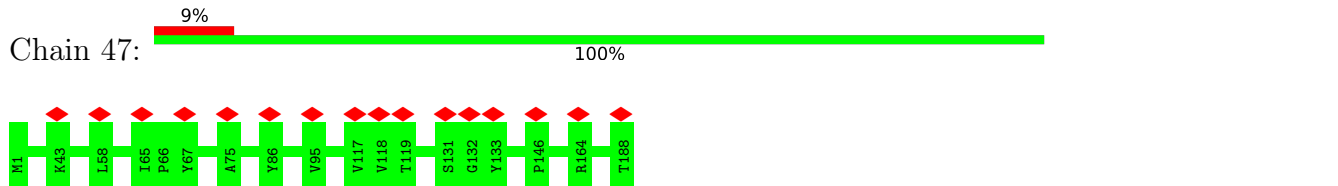

- Molecule 13: Iron-binding zinc finger CDGSH type protein



There are no outlier residues recorded for this chain.

- Molecule 13: Iron-binding zinc finger CDGSH type protein

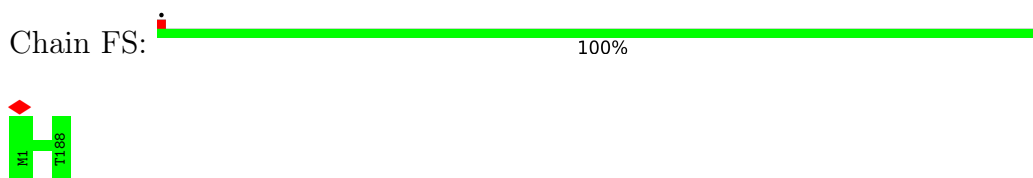

- Molecule 14: Phage protein

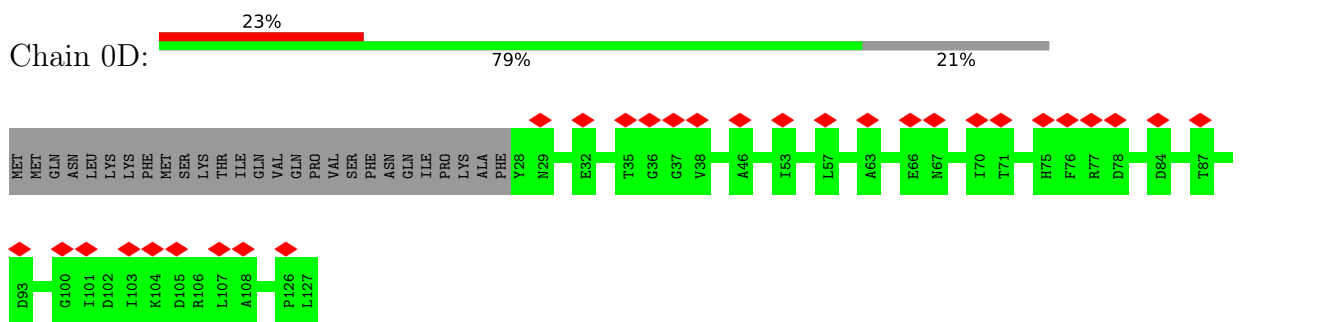

- Molecule 14: Phage protein

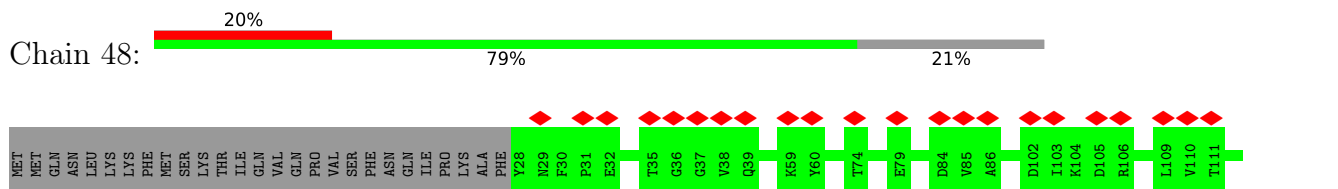

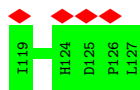

• Molecule 14: Phage protein

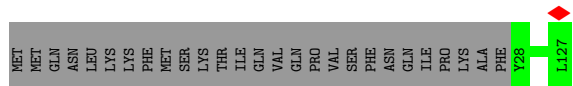
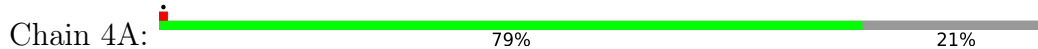

• Molecule 14: Phage protein

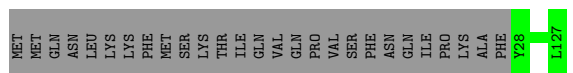
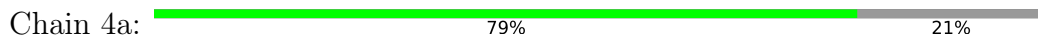

• Molecule 15: Ymf67

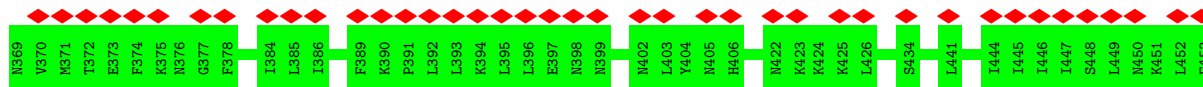
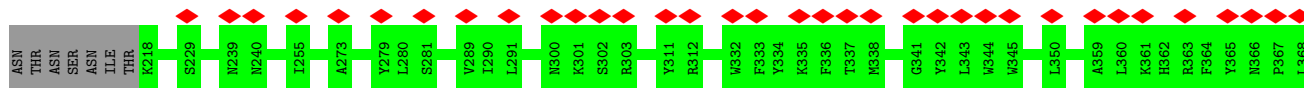
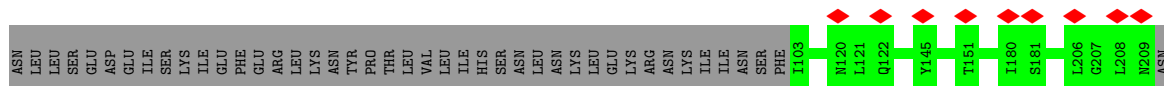
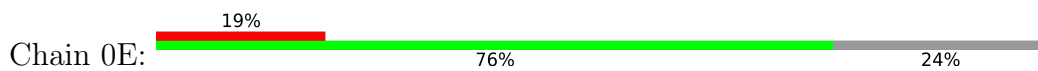

• Molecule 15: Ymf67

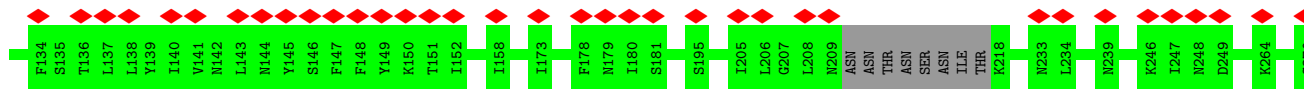
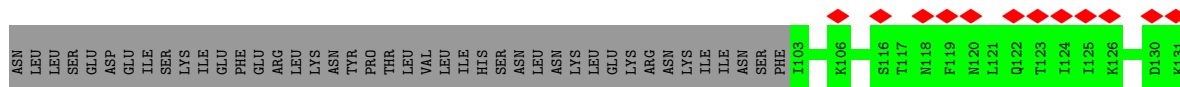
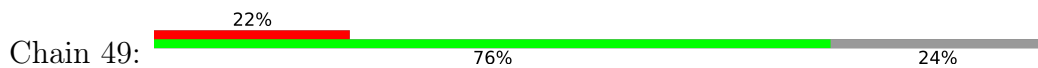





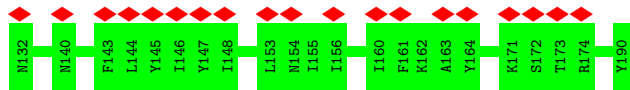
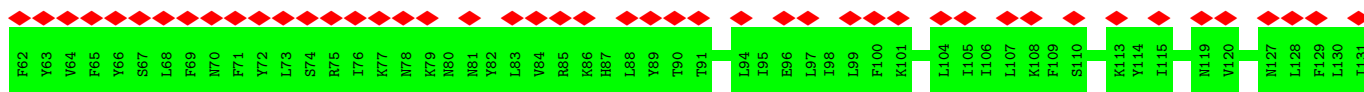

• Molecule 16: Ymf75

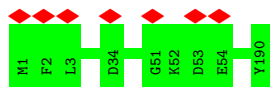

• Molecule 16: Ymf75

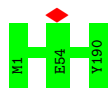

• Molecule 17: Ymf70

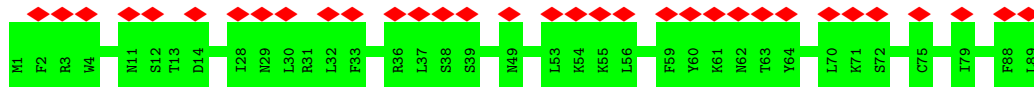
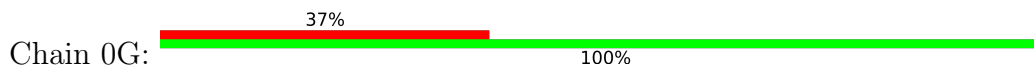

• Molecule 17: Ymf70

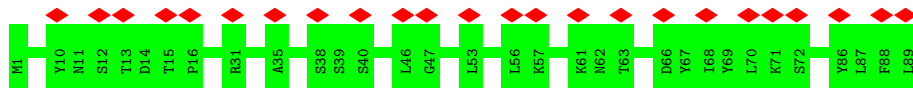

• Molecule 17: Ymf70



There are no outlier residues recorded for this chain.

• Molecule 17: Ymf70



• Molecule 18: COXTT28

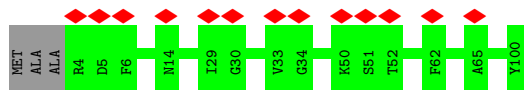

• Molecule 18: COXTT28

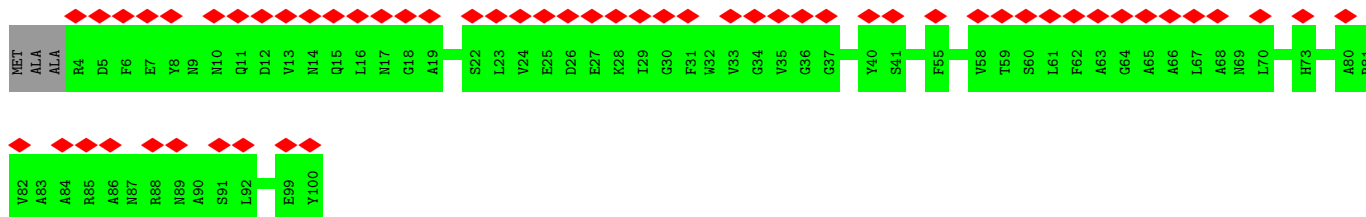

• Molecule 18: COXTT28

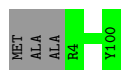

• Molecule 18: COXTT28

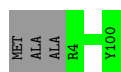

• Molecule 19: Unknown peptide

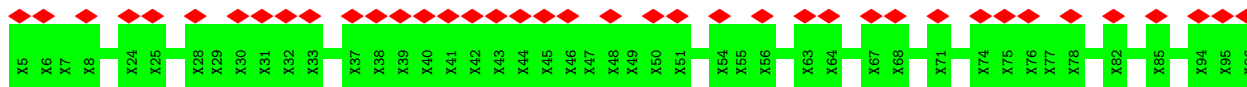
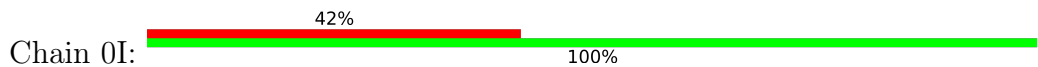

• Molecule 19: Unknown peptide

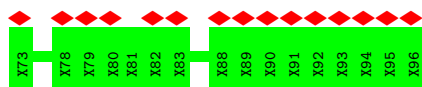
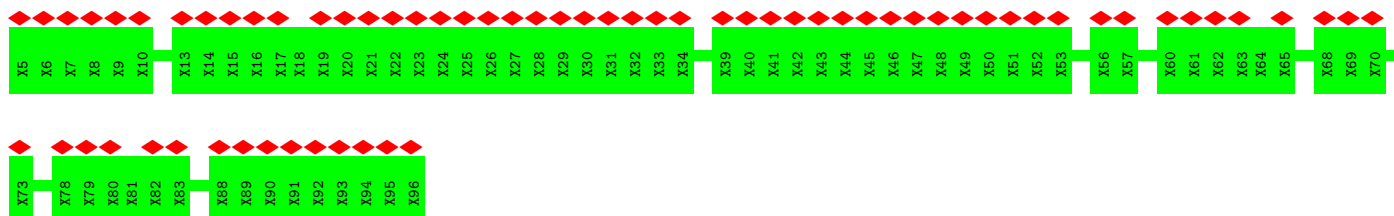
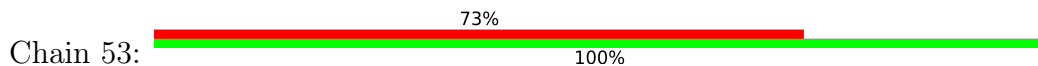

• Molecule 19: Unknown peptide

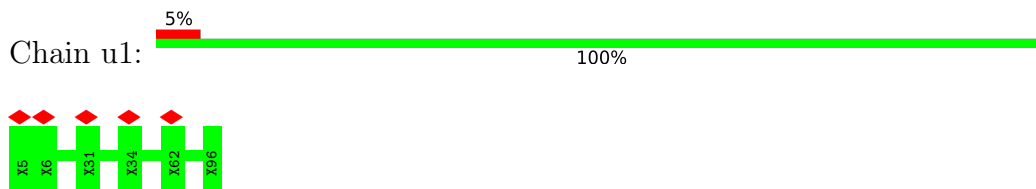

• Molecule 19: Unknown peptide

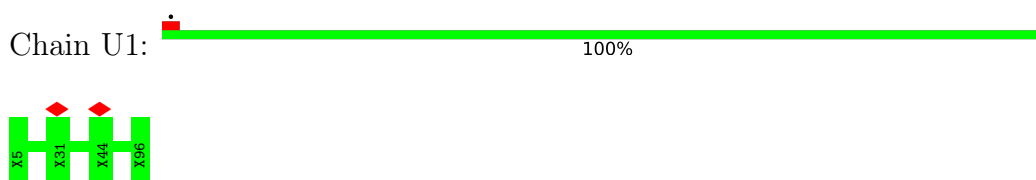

• Molecule 20: unknown peptide

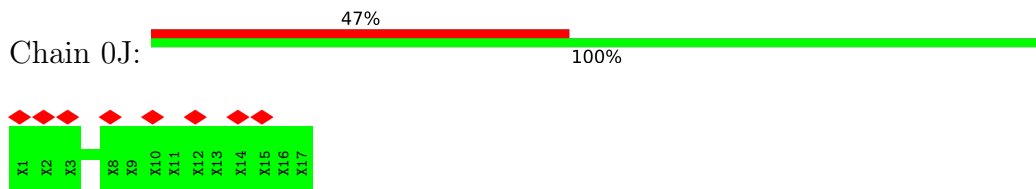

• Molecule 20: unknown peptide

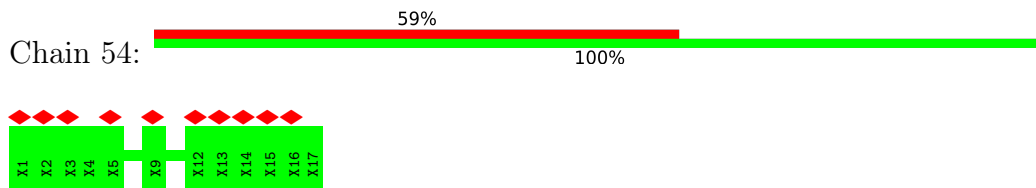

• Molecule 20: unknown peptide

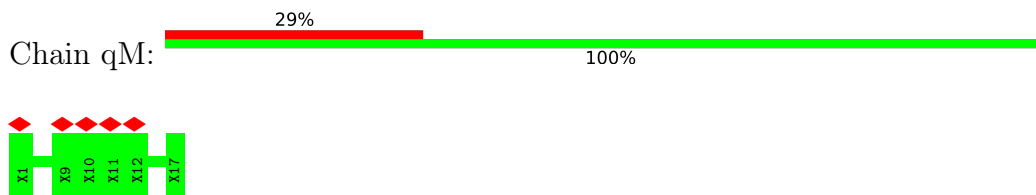

• Molecule 20: unknown peptide

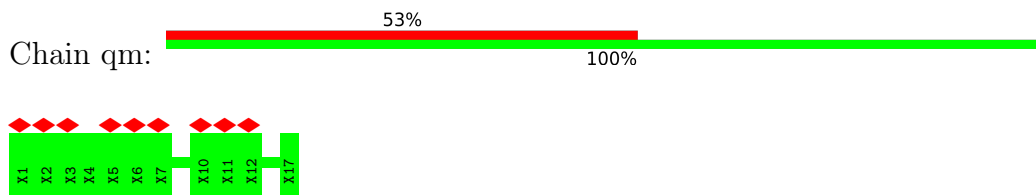

• Molecule 20: unknown peptide



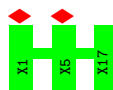

• Molecule 20: unknown peptide



There are no outlier residues recorded for this chain.

• Molecule 20: unknown peptide



• Molecule 20: unknown peptide



• Molecule 21: 39S ribosomal protein L9, mitochondrial

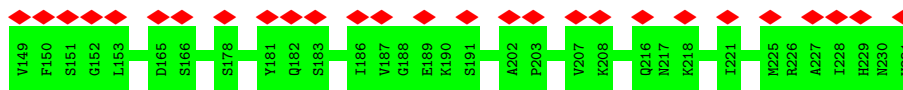
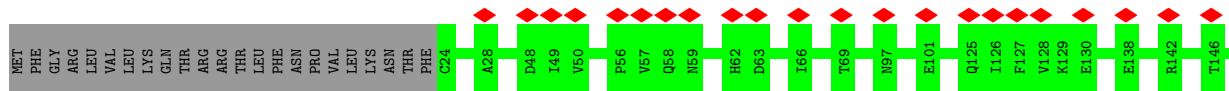

• Molecule 21: 39S ribosomal protein L9, mitochondrial

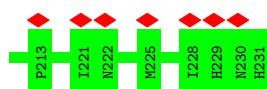
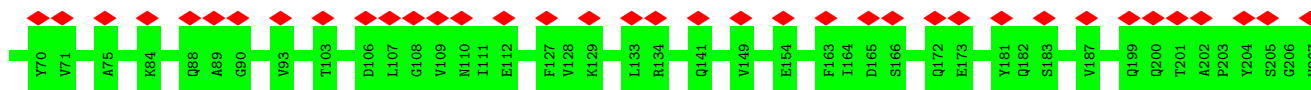
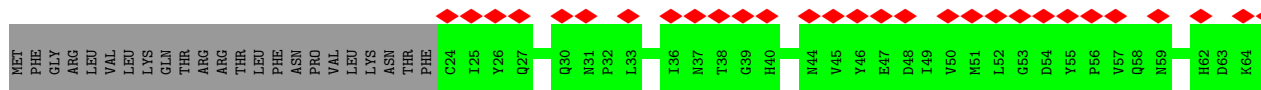
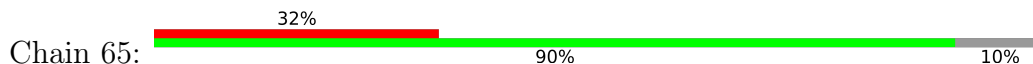

- Molecule 21: 39S ribosomal protein L9, mitochondrial

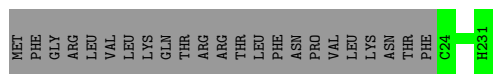

- Molecule 21: 39S ribosomal protein L9, mitochondrial

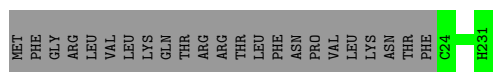
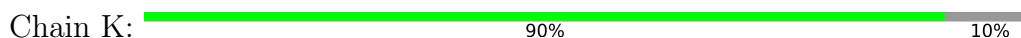

- Molecule 22: Ubiquinol-cytochrome c reductase complex ubiquinone-binding protein QP-C

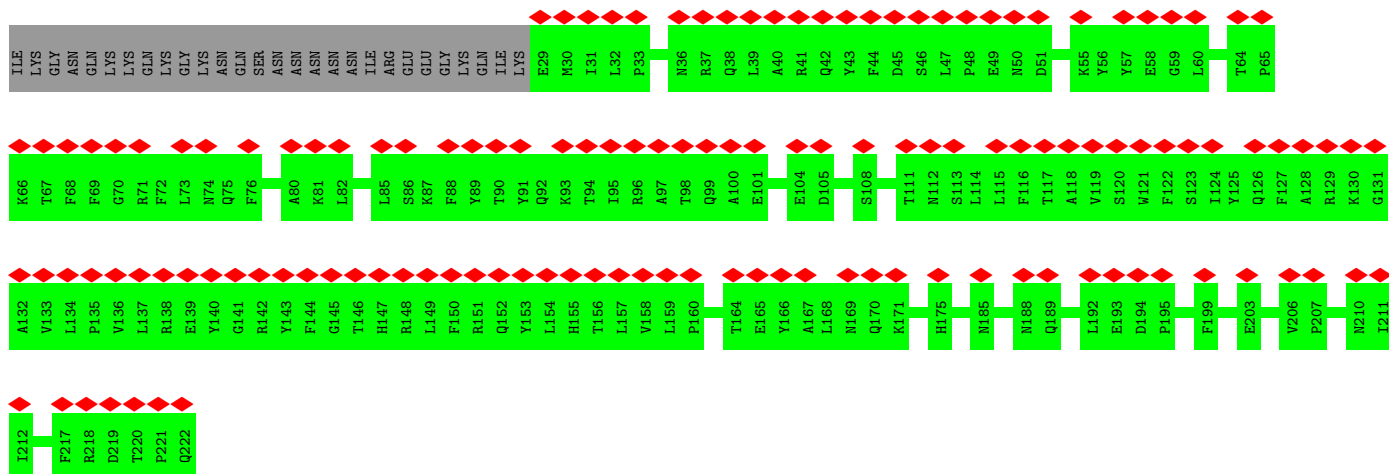
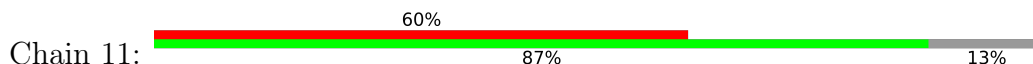

- Molecule 22: Ubiquinol-cytochrome c reductase complex ubiquinone-binding protein QP-C

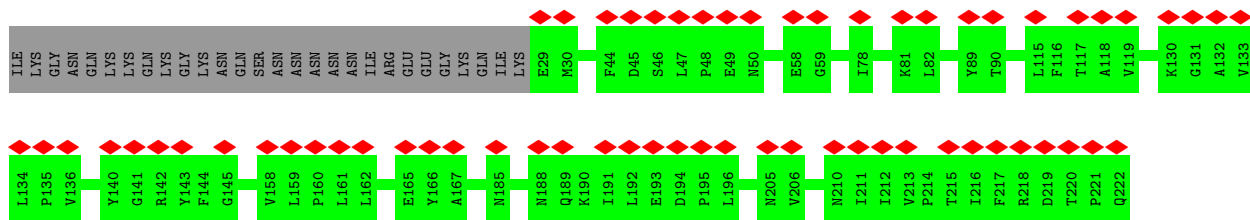
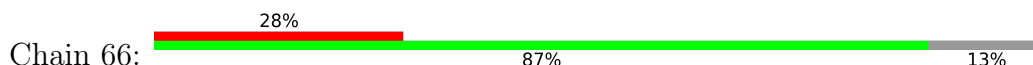

- Molecule 22: Ubiquinol-cytochrome c reductase complex ubiquinone-binding protein QP-C

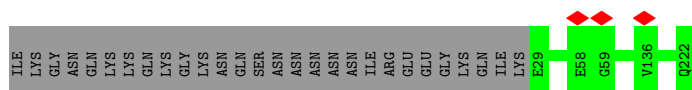
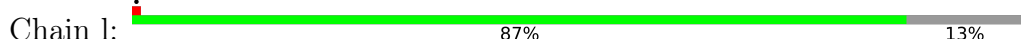

- Molecule 22: Ubiquinol-cytochrome c reductase complex ubiquinone-binding protein QP-C

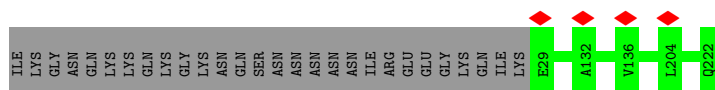
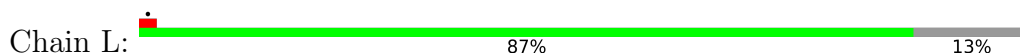

- Molecule 23: Transmembrane protein, putative

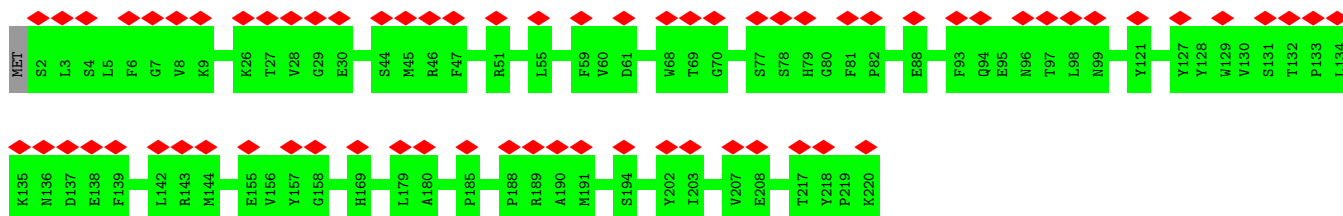

- Molecule 23: Transmembrane protein, putative

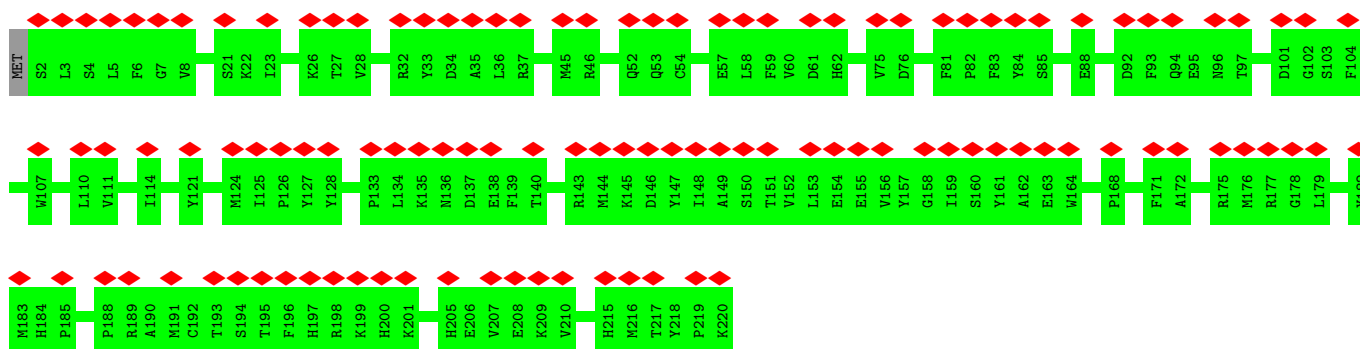

- Molecule 23: Transmembrane protein, putative



- Molecule 23: Transmembrane protein, putative

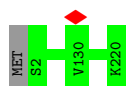

- Molecule 24: Transmembrane protein, putative





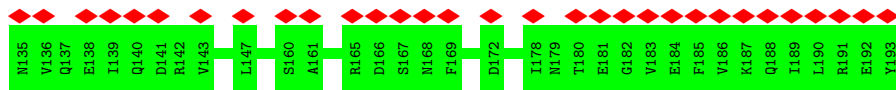

• Molecule 25: Mobilization protein

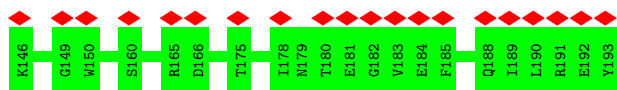
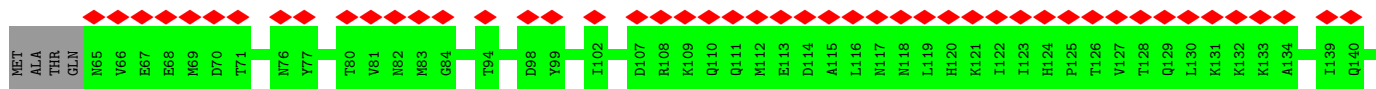
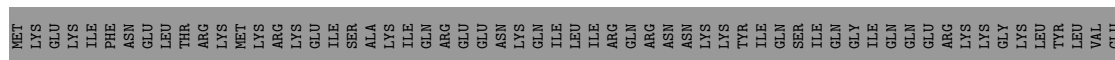

• Molecule 25: Mobilization protein

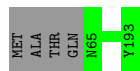
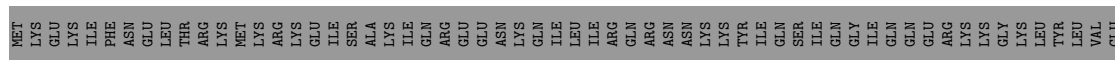

• Molecule 25: Mobilization protein

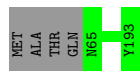

• Molecule 26: YfiT domain-containing protein

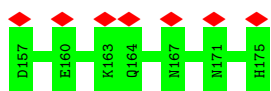
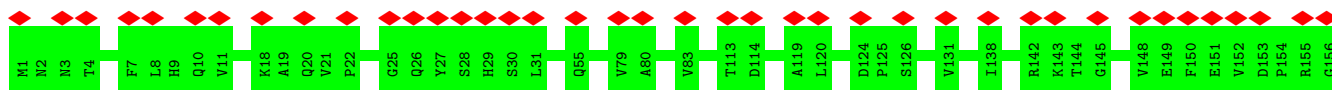

• Molecule 26: YfiT domain-containing protein

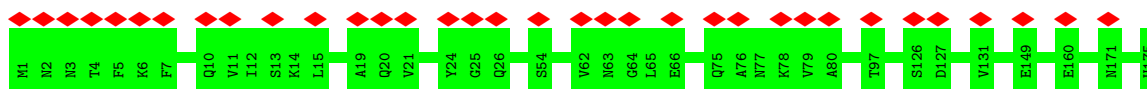

- Molecule 26: YffT domain-containing protein



There are no outlier residues recorded for this chain.

- Molecule 26: YffT domain-containing protein



There are no outlier residues recorded for this chain.

- Molecule 27: Transmembrane protein, putative

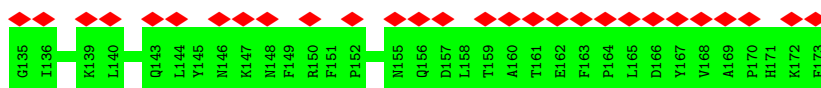
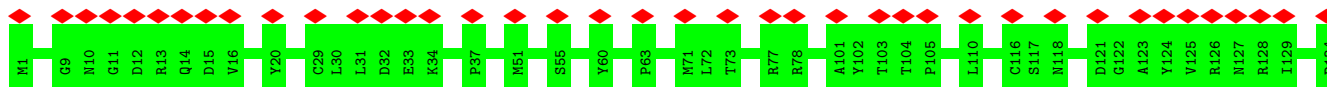
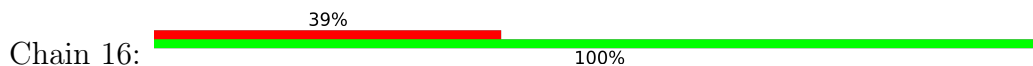

- Molecule 27: Transmembrane protein, putative

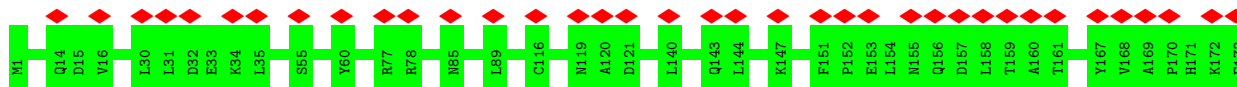

- Molecule 27: Transmembrane protein, putative



There are no outlier residues recorded for this chain.

- Molecule 27: Transmembrane protein, putative

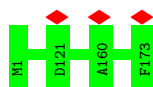

- Molecule 28: Transmembrane protein

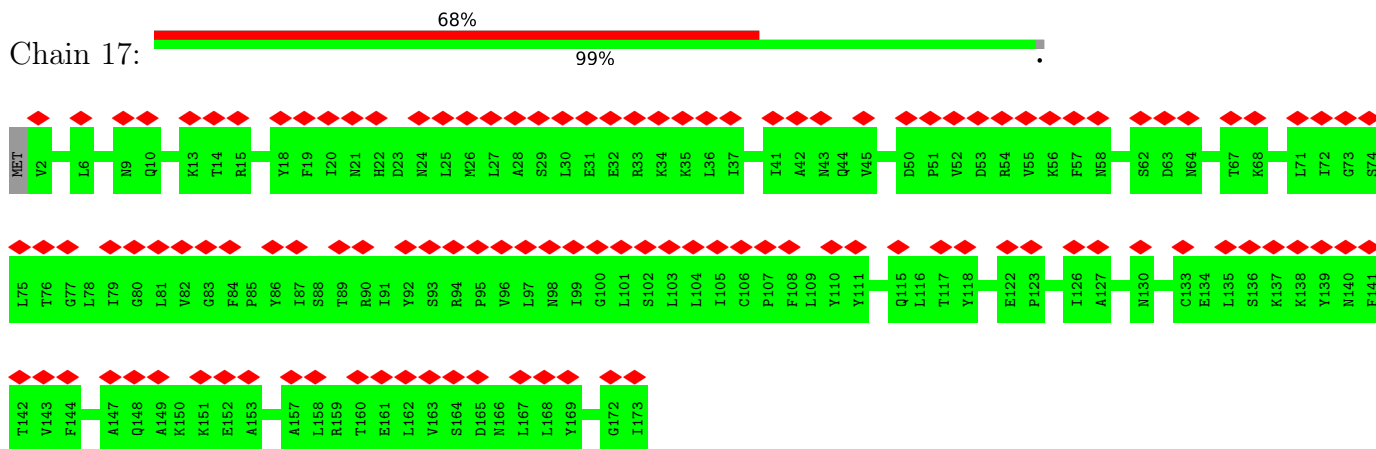

• Molecule 28: Transmembrane protein

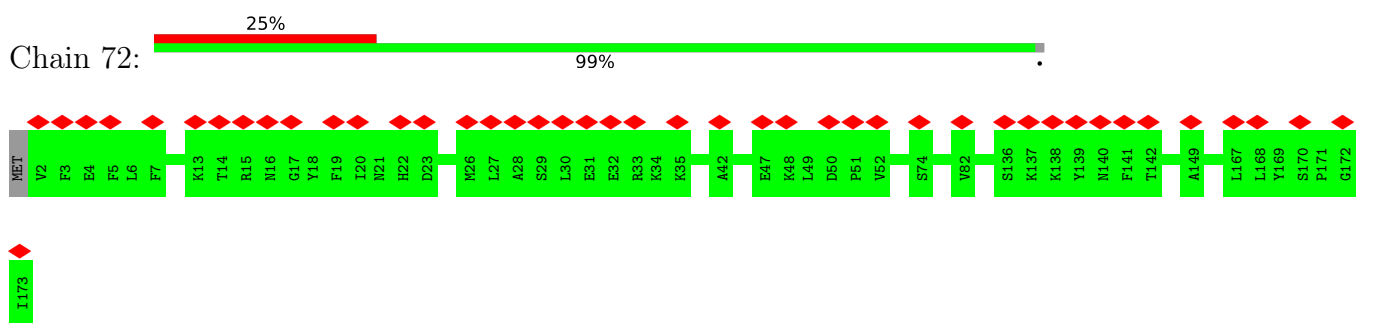

• Molecule 28: Transmembrane protein



• Molecule 28: Transmembrane protein

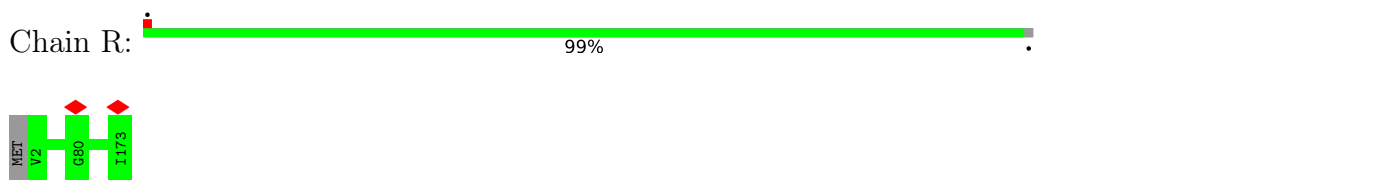

• Molecule 29: Complex III subunit VII

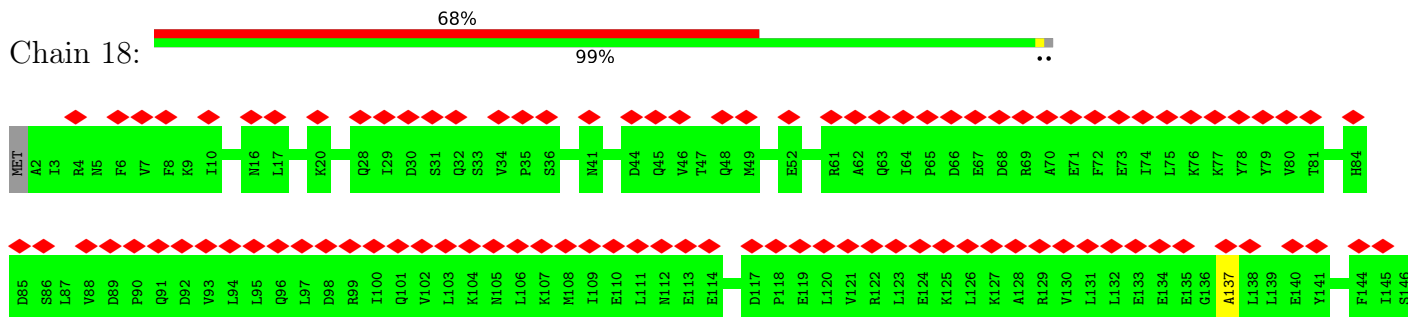

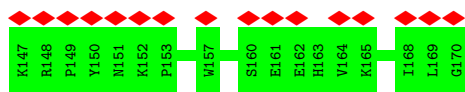

- Molecule 29: Complex III subunit VII

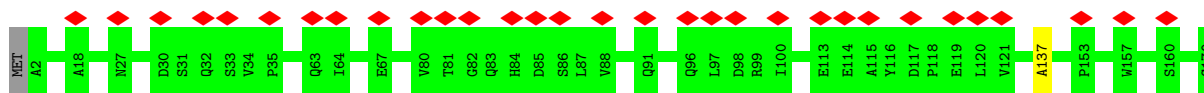

- Molecule 29: Complex III subunit VII

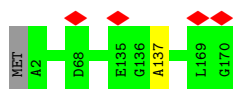

- Molecule 29: Complex III subunit VII

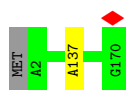

- Molecule 30: Transmembrane protein, putative

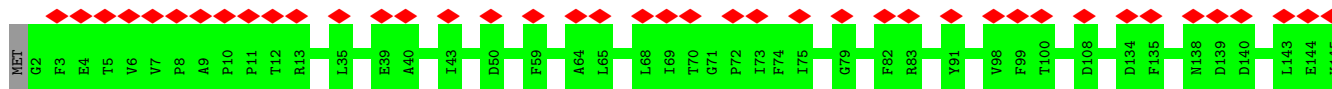

- Molecule 30: Transmembrane protein, putative

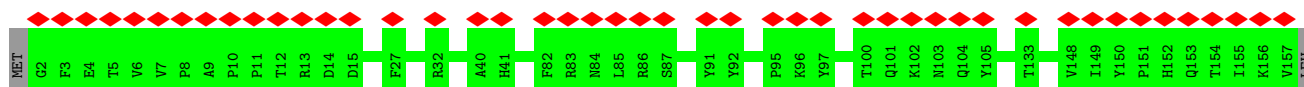

- Molecule 30: Transmembrane protein, putative



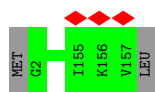

- Molecule 30: Transmembrane protein, putative

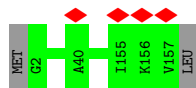

- Molecule 31: NADH dehydrogenase subunit 1

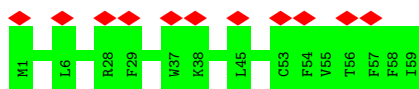

- Molecule 31: NADH dehydrogenase subunit 1



- Molecule 32: Transmembrane protein, putative

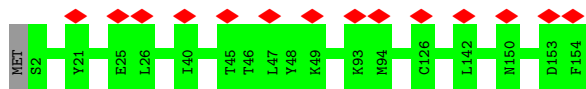

- Molecule 32: Transmembrane protein, putative

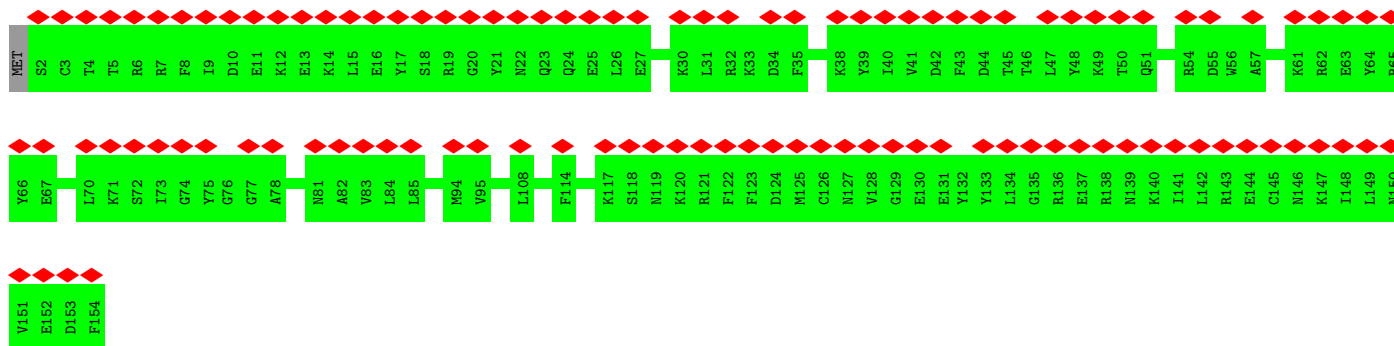

- Molecule 32: Transmembrane protein, putative

Chain u:  99%

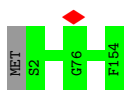

- Molecule 32: Transmembrane protein, putative

Chain U:  99%

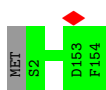

- Molecule 33: COXTT22

Chain 21:  11% 98%



- Molecule 33: COXTT22

Chain 76:  54% 98%

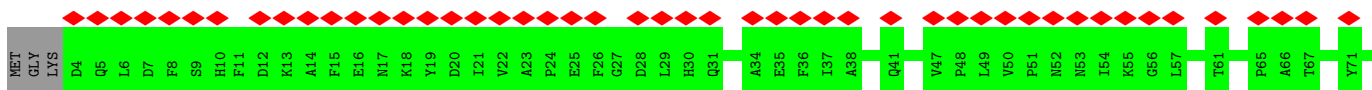

- Molecule 33: COXTT22

Chain v:  98%

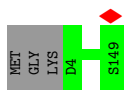

- Molecule 33: COXTT22

Chain V:  98%

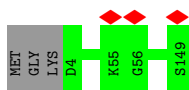

- Molecule 34: Transmembrane protein, putative

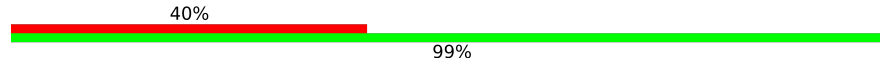
Chain 22:  40% 99%

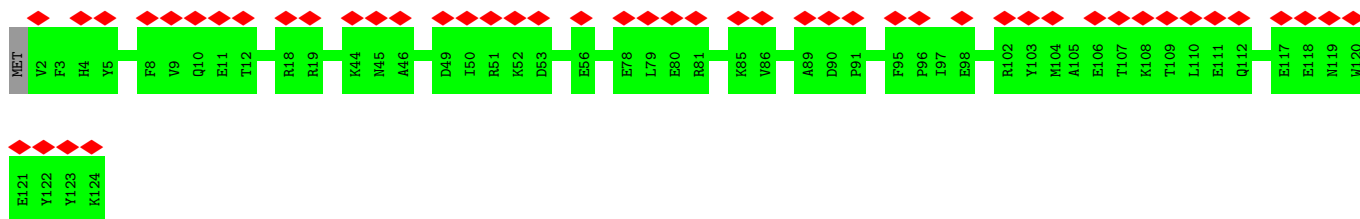

- Molecule 34: Transmembrane protein, putative

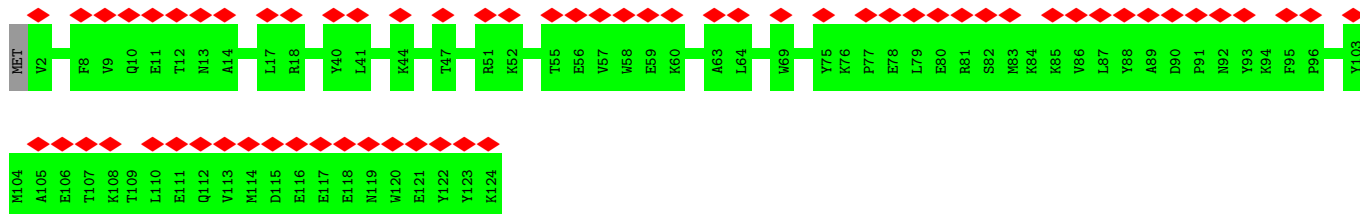

- Molecule 34: Transmembrane protein, putative



- Molecule 34: Transmembrane protein, putative



- Molecule 35: Transmembrane protein, putative

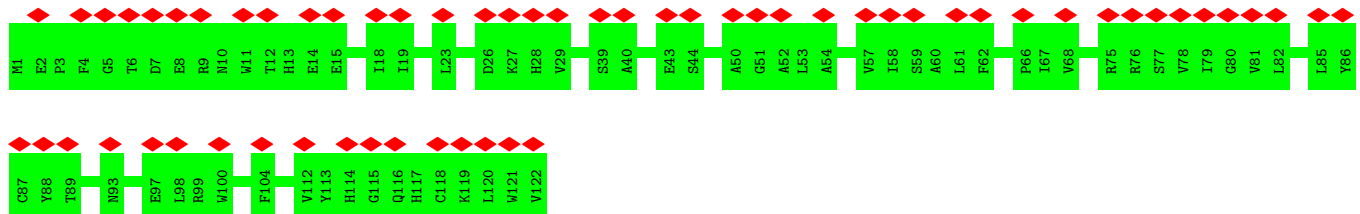

- Molecule 35: Transmembrane protein, putative

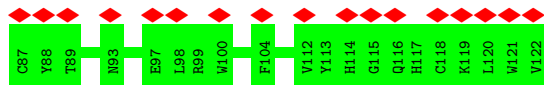

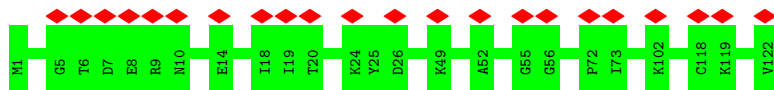

- Molecule 35: Transmembrane protein, putative

Chain x: 100%

There are no outlier residues recorded for this chain.

- Molecule 35: Transmembrane protein, putative

Chain X: 100%



- Molecule 36: Lysozyme

Chain 24: 49%

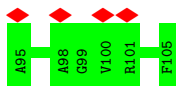
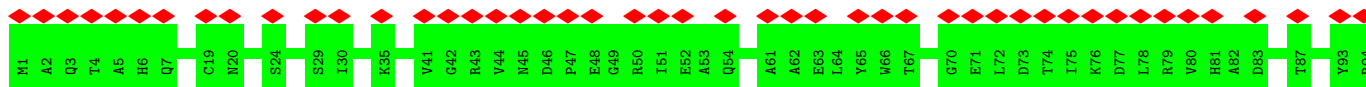

- Molecule 36: Lysozyme

Chain 79: 58%

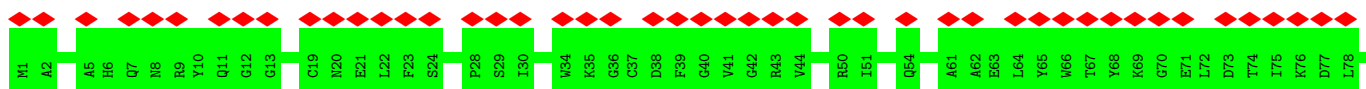

- Molecule 36: Lysozyme

Chain y: 100%



- Molecule 36: Lysozyme

Chain Y: 100%



There are no outlier residues recorded for this chain.

• Molecule 37: ABC transporter

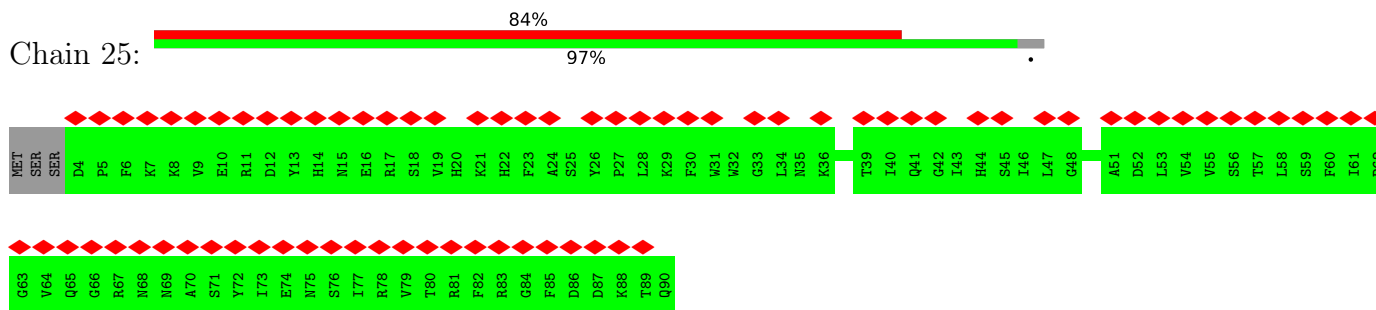

• Molecule 37: ABC transporter

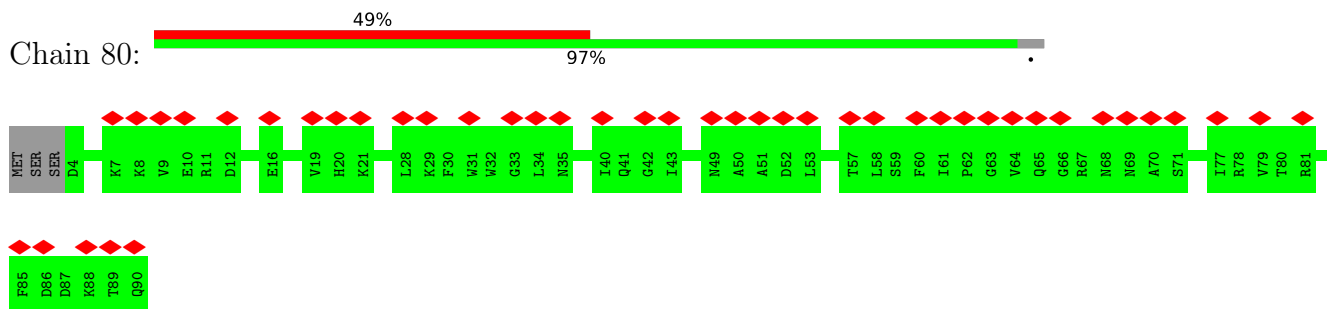

• Molecule 37: ABC transporter

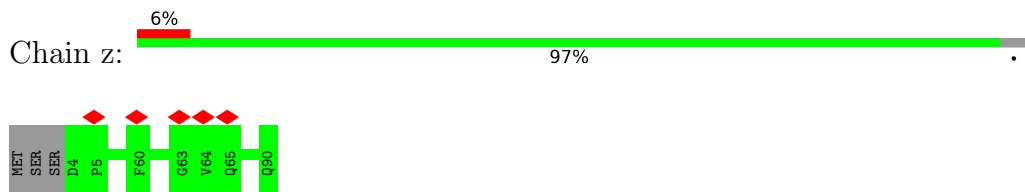

• Molecule 37: ABC transporter

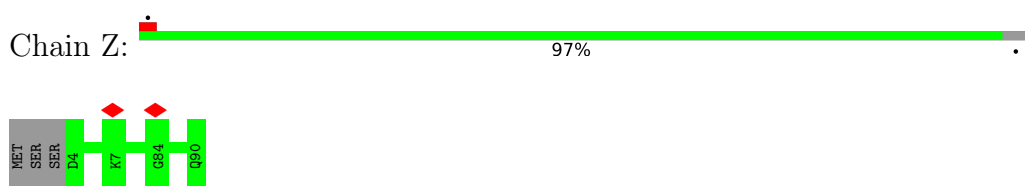

• Molecule 38: Cytochrome c oxidase subunit 1

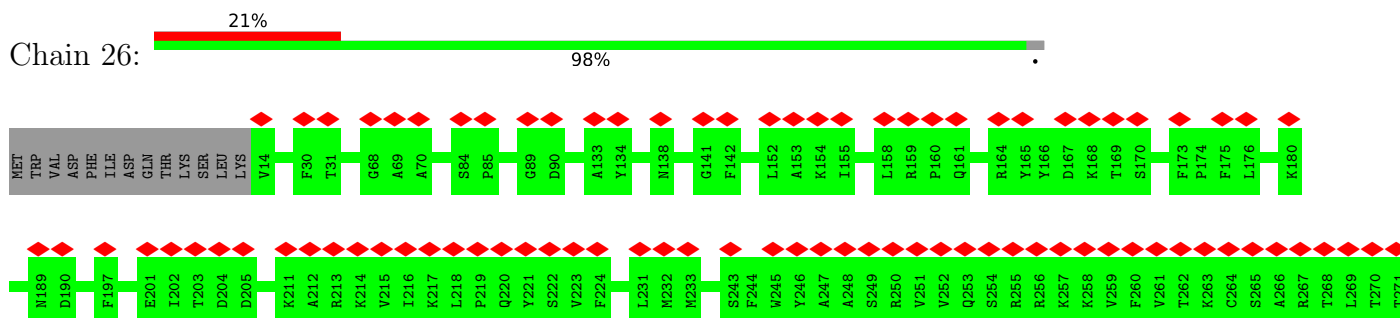

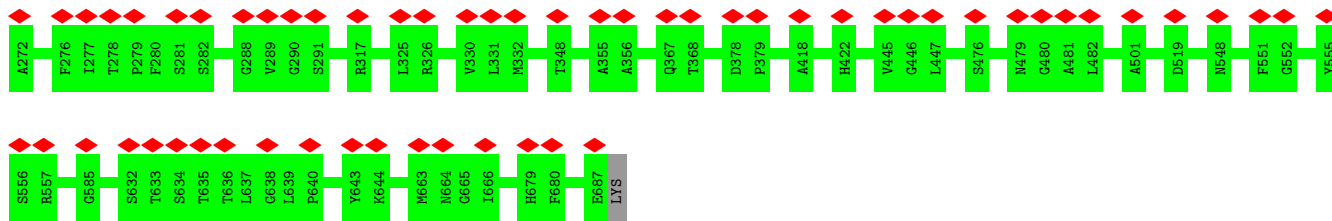

• Molecule 38: Cytochrome c oxidase subunit 1

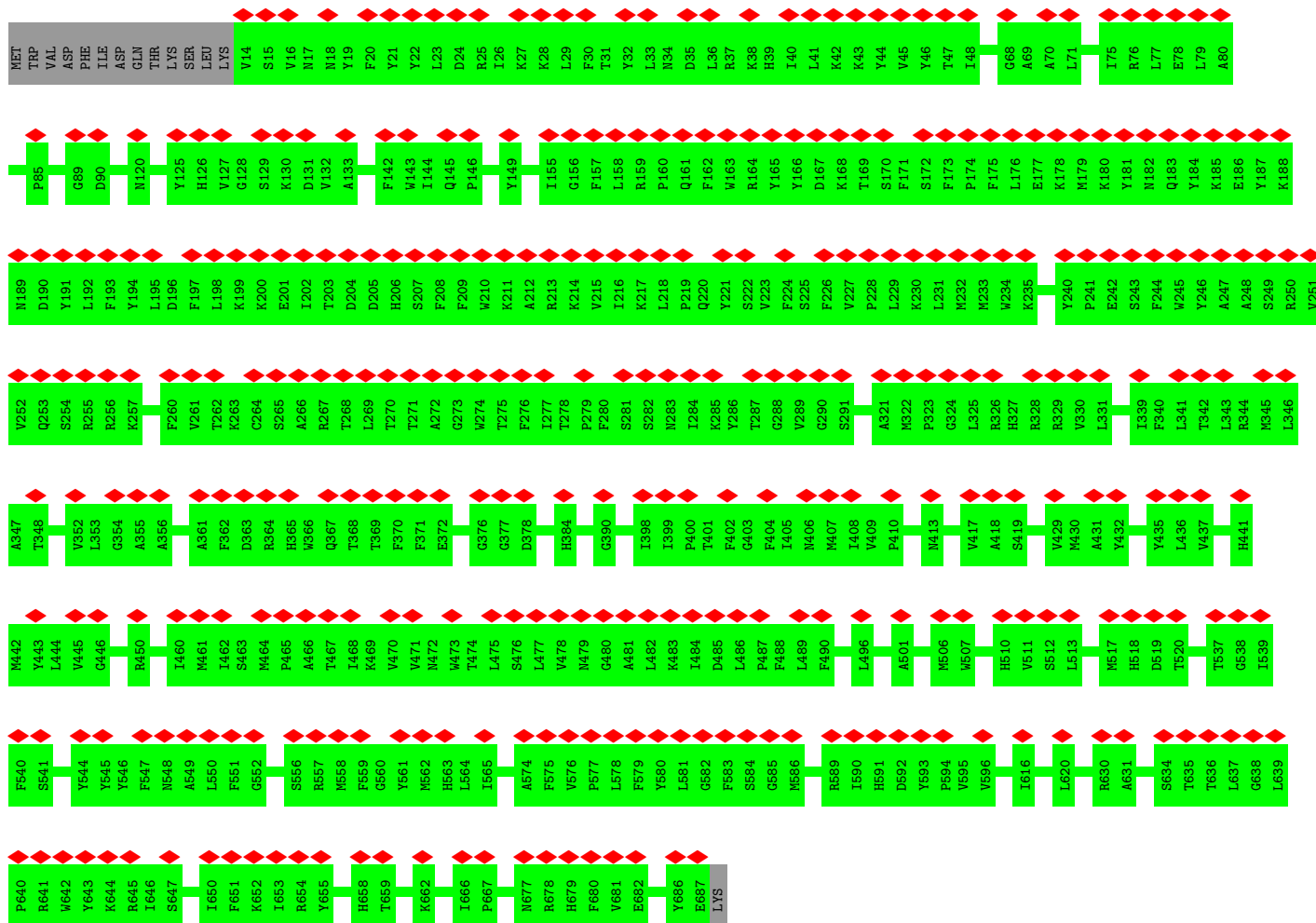

• Molecule 38: Cytochrome c oxidase subunit 1

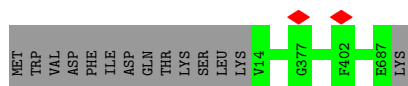

• Molecule 38: Cytochrome c oxidase subunit 1

Chain C1:  98%

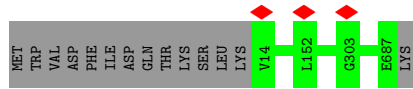

● Molecule 39: Cytochrome c oxidase subunit 2

Chain 27:  35% 99%

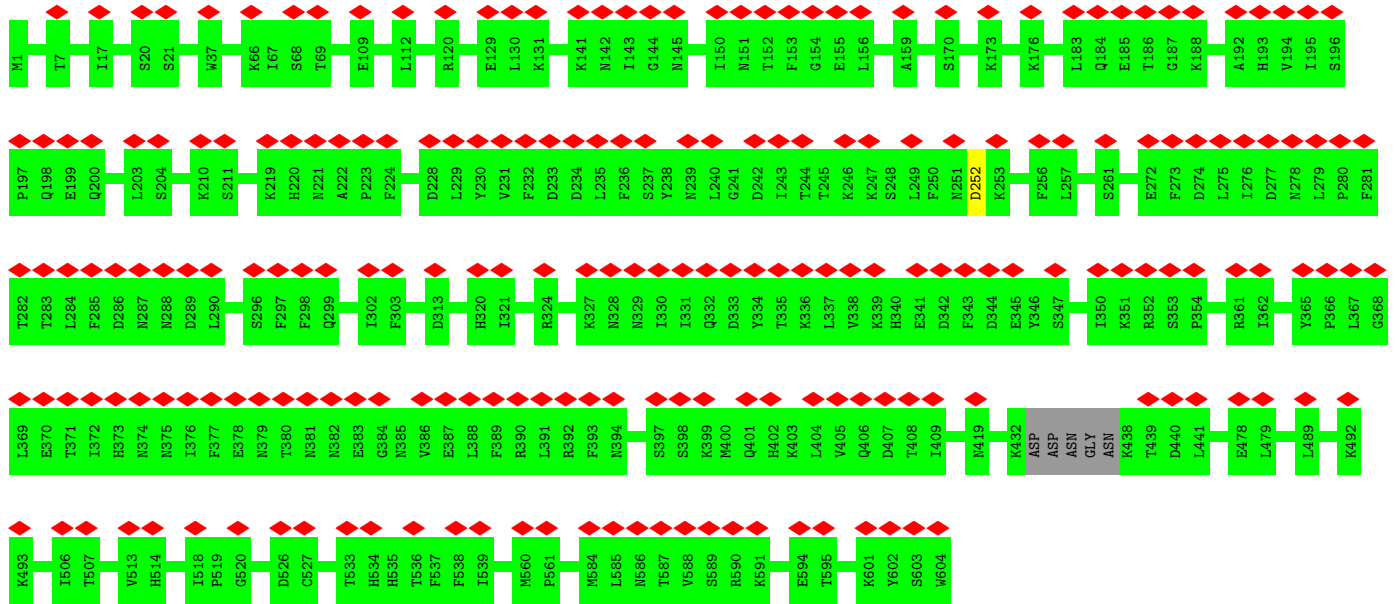

● Molecule 39: Cytochrome c oxidase subunit 2

Chain 82:  58% 99%

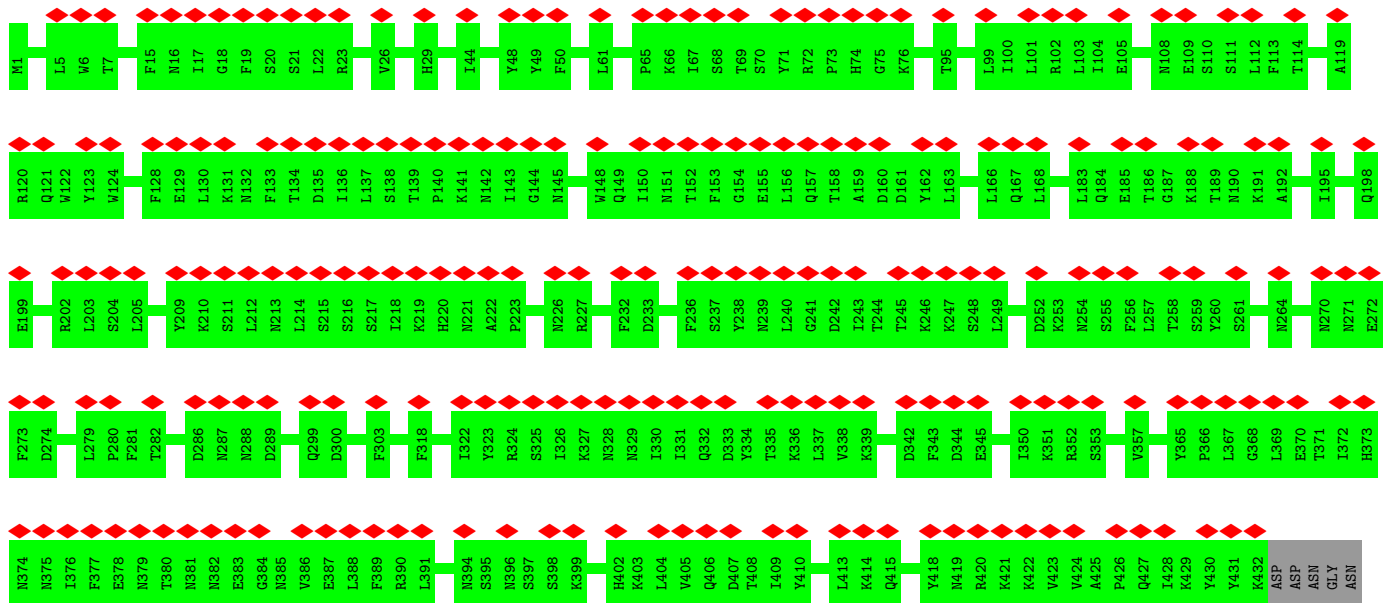

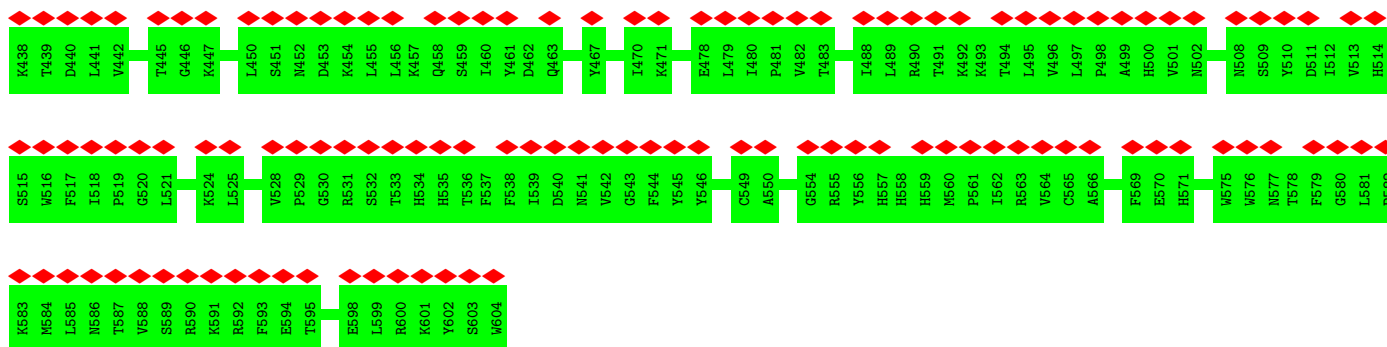

- Molecule 39: Cytochrome c oxidase subunit 2

Chain c2: 99%

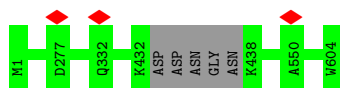

- Molecule 39: Cytochrome c oxidase subunit 2

Chain C2: 99%

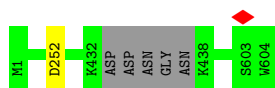

- Molecule 40: Ymf68

Chain 28: 27% 98%

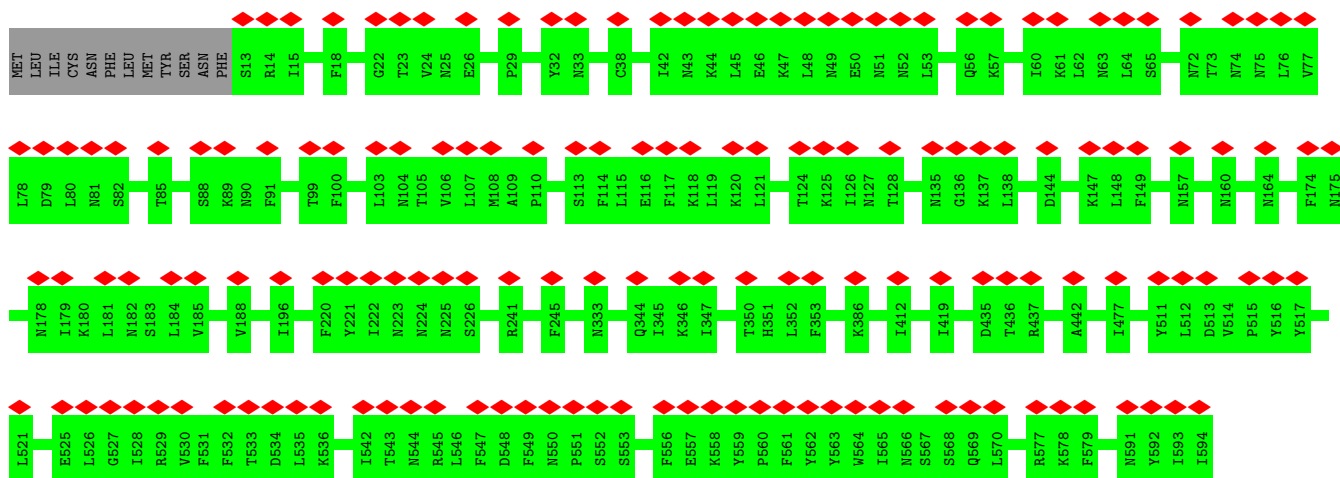

- Molecule 40: Ymf68

Chain 83: 24% 98%

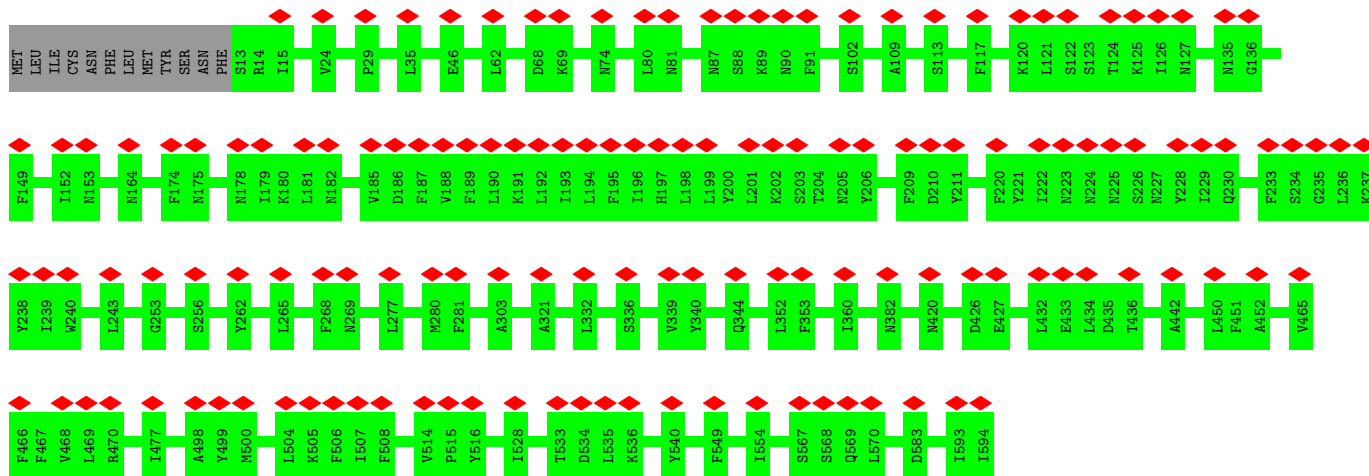

• Molecule 40: Ymf68

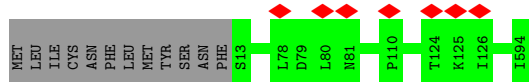

• Molecule 40: Ymf68

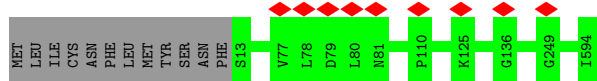

• Molecule 41: Cytochrome C oxidase subunit Vb protein

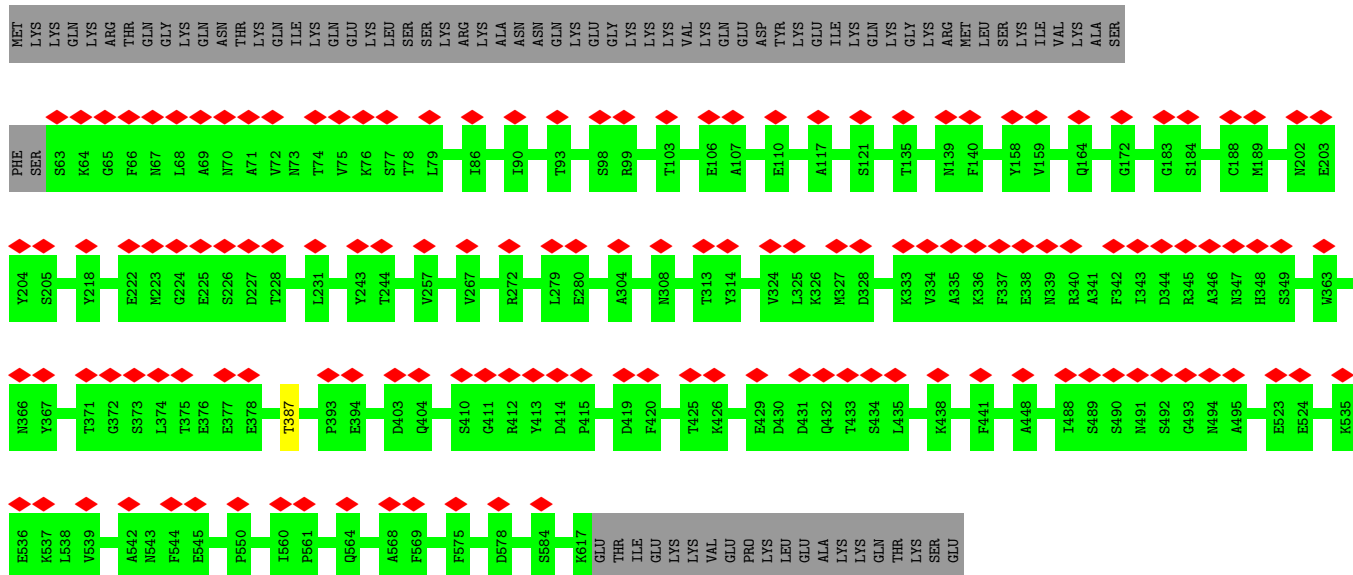
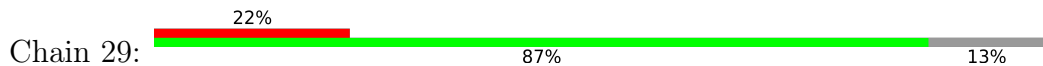





• Molecule 43: NmrA domain-containing protein

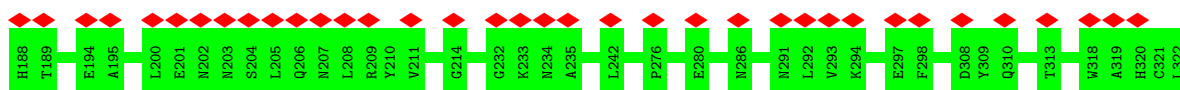
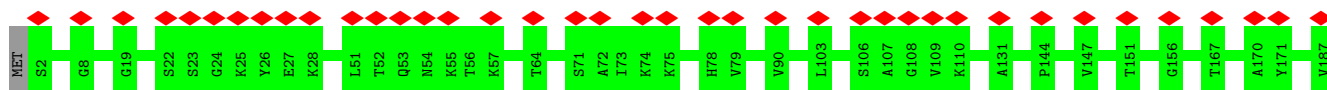

• Molecule 43: NmrA domain-containing protein

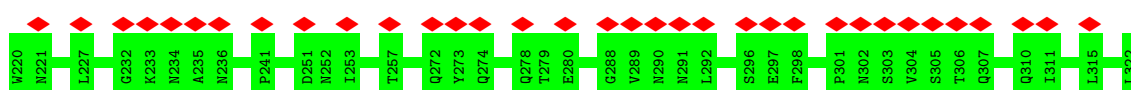
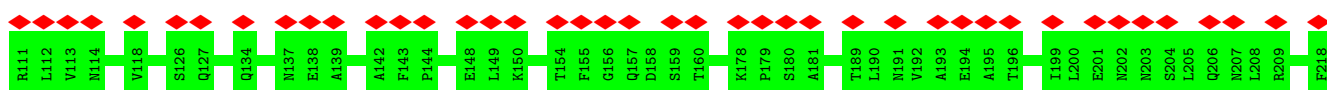
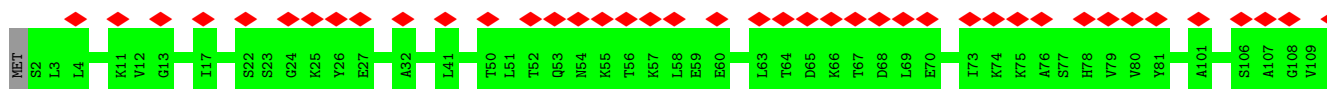

• Molecule 44: Transmembrane protein, putative

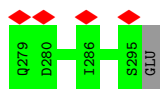
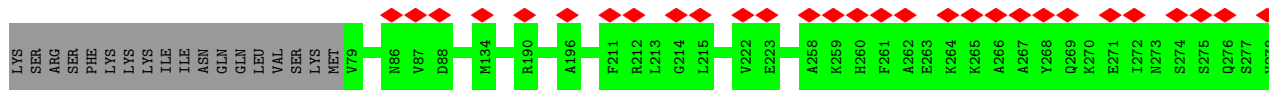
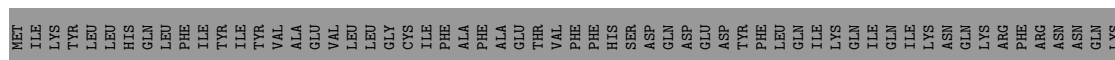

• Molecule 44: Transmembrane protein, putative

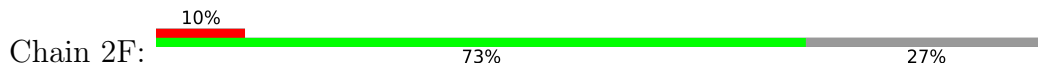

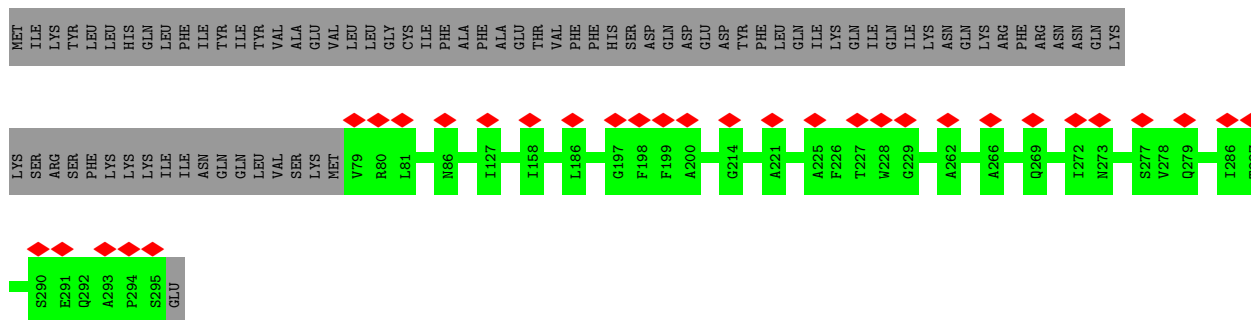

• Molecule 45: SDHTT3

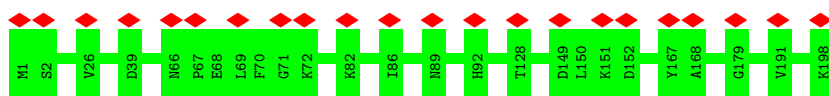

• Molecule 45: SDHTT3

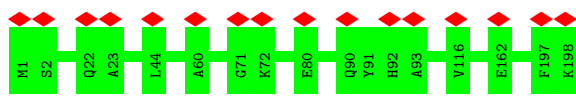

• Molecule 46: Diphthamide synthesis protein

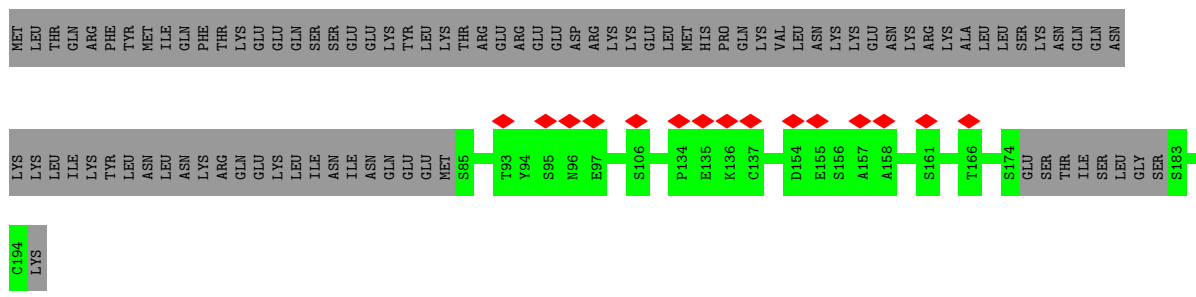

• Molecule 46: Diphthamide synthesis protein

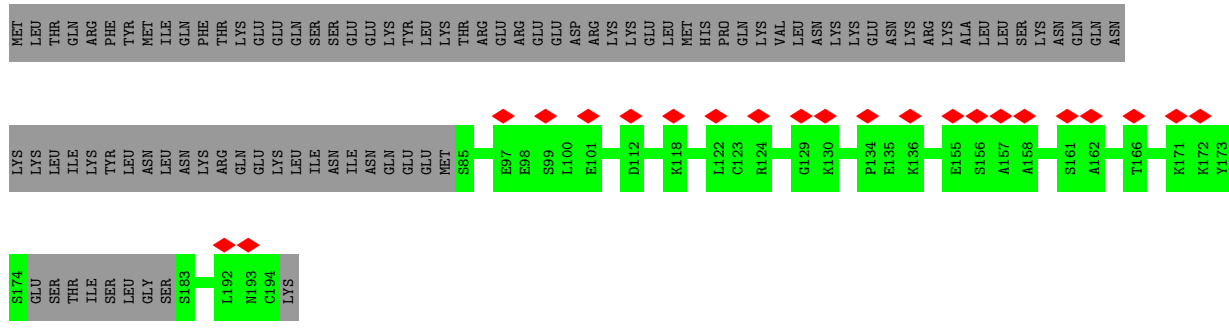



- Molecule 47: DUF4885 domain-containing protein

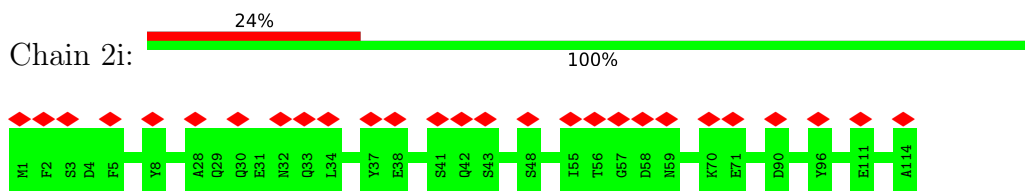

- Molecule 47: DUF4885 domain-containing protein

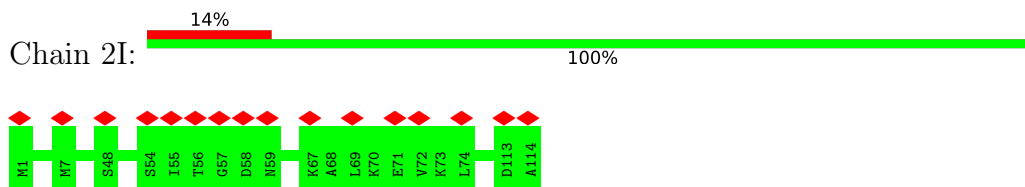

- Molecule 48: Transmembrane protein, putative

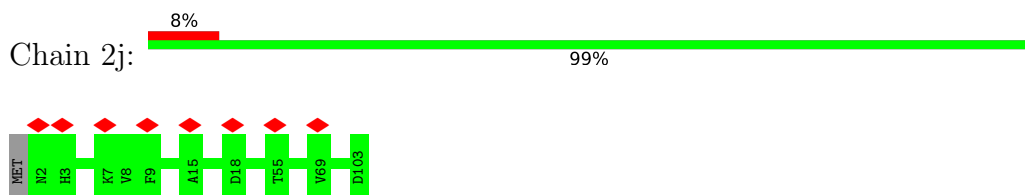

- Molecule 48: Transmembrane protein, putative

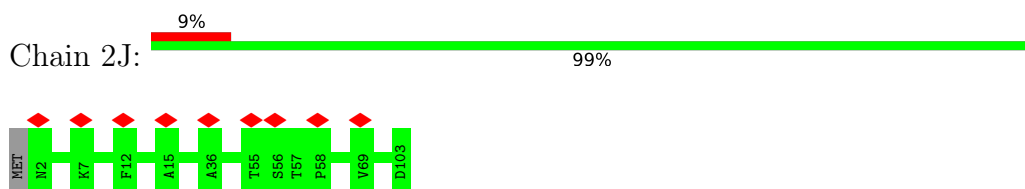

- Molecule 49: Transmembrane protein, putative

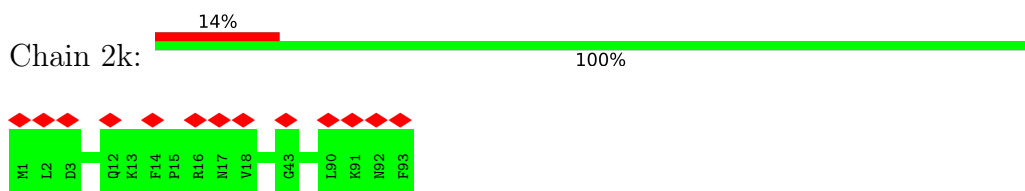

- Molecule 49: Transmembrane protein, putative

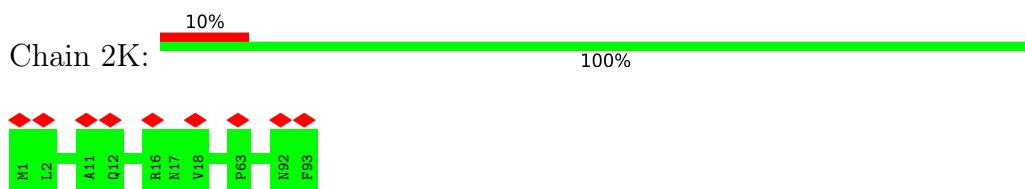

- Molecule 50: Transposase



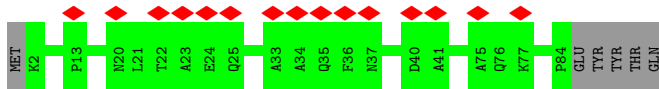

- Molecule 50: Transposase

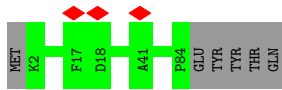

- Molecule 51: Transmembrane protein, putative

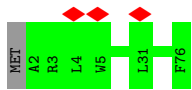

- Molecule 51: Transmembrane protein, putative

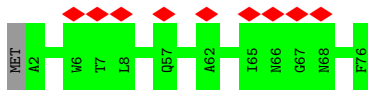

- Molecule 52: Transmembrane protein, putative

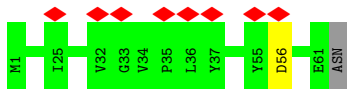

- Molecule 52: Transmembrane protein, putative

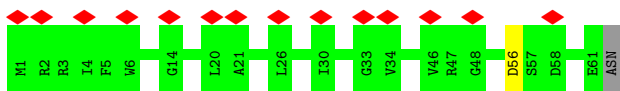

- Molecule 53: SDHTT11

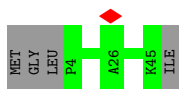

- Molecule 53: SDHTT11

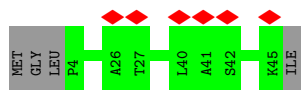
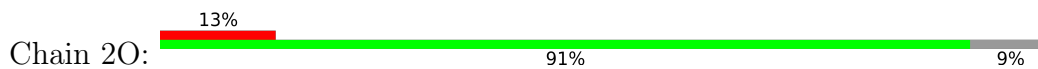

• Molecule 54: Transmembrane protein, putative

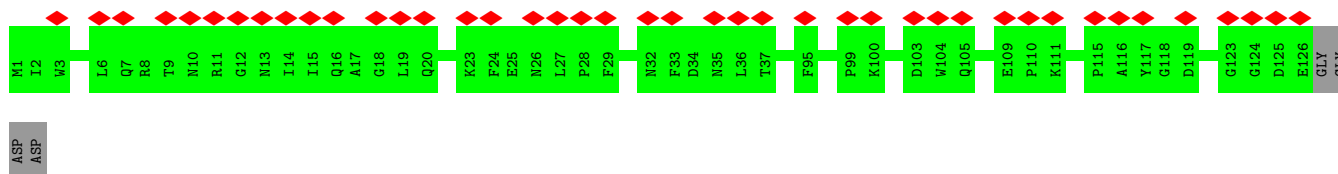

• Molecule 54: Transmembrane protein, putative

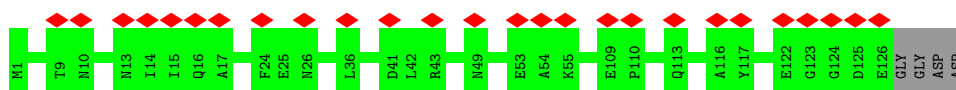

• Molecule 54: Transmembrane protein, putative

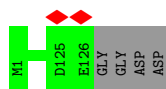

• Molecule 54: Transmembrane protein, putative

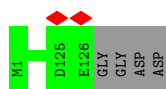

• Molecule 55: Structural protein

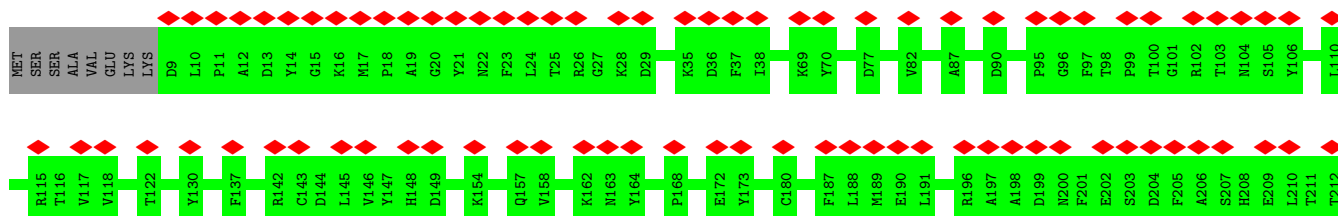
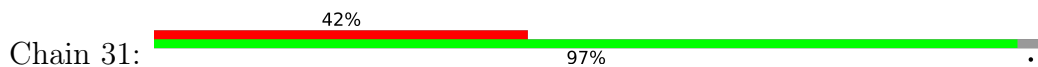

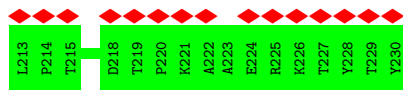

- Molecule 55: Structural protein

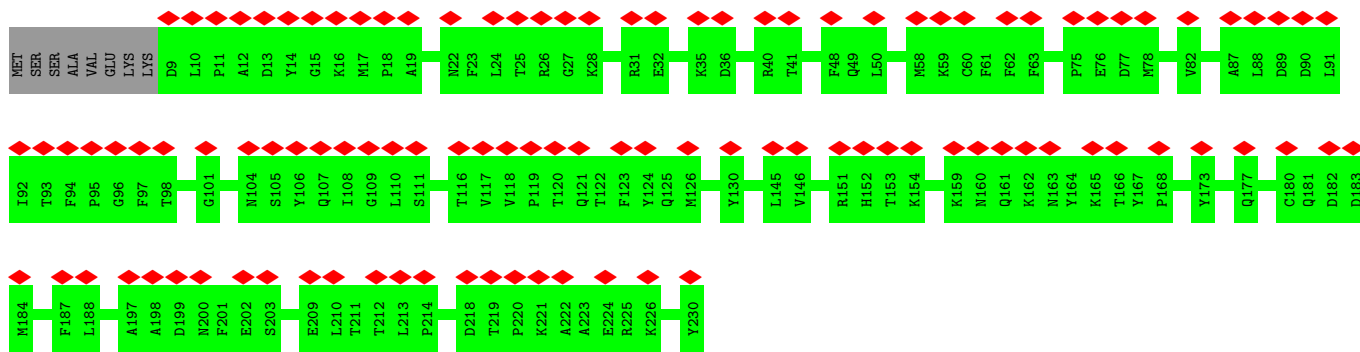

- Molecule 55: Structural protein

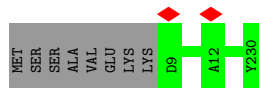

- Molecule 55: Structural protein

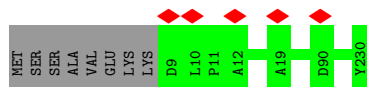

- Molecule 56: Transmembrane protein, putative

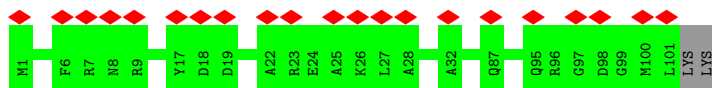

- Molecule 56: Transmembrane protein, putative

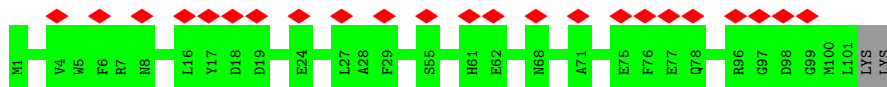

- Molecule 56: Transmembrane protein, putative

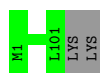

- Molecule 56: Transmembrane protein, putative

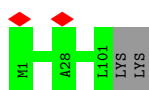

- Molecule 57: Decapping nuclease

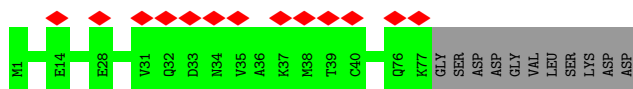
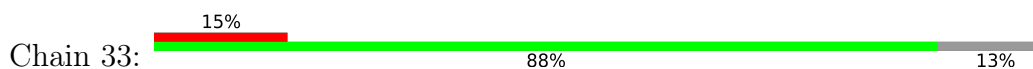

- Molecule 57: Decapping nuclease

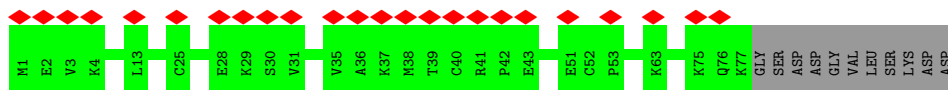
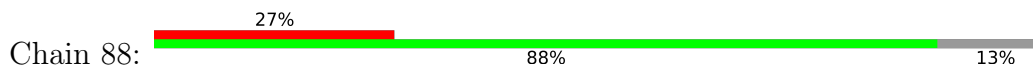

- Molecule 57: Decapping nuclease

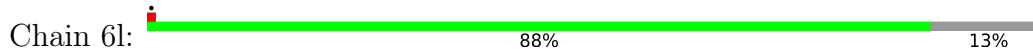

- Molecule 57: Decapping nuclease

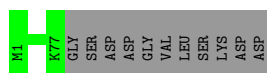
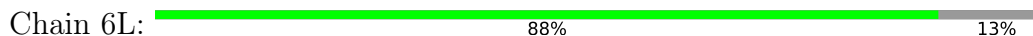

- Molecule 58: Transmembrane protein, putative

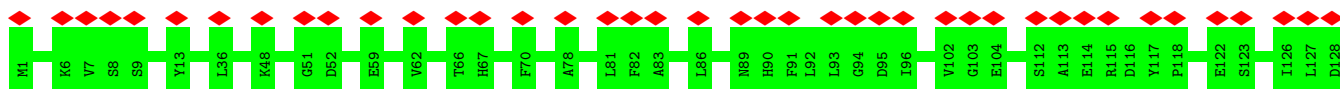



- Molecule 58: Transmembrane protein, putative

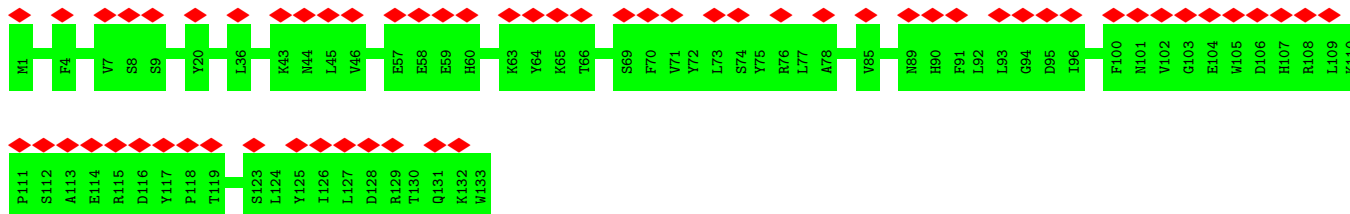

- Molecule 58: Transmembrane protein, putative



There are no outlier residues recorded for this chain.

- Molecule 58: Transmembrane protein, putative

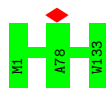

- Molecule 59: NADH dehydrogenase [ubiquinone] 1 beta subcomplex subunit 8, mitochondrial

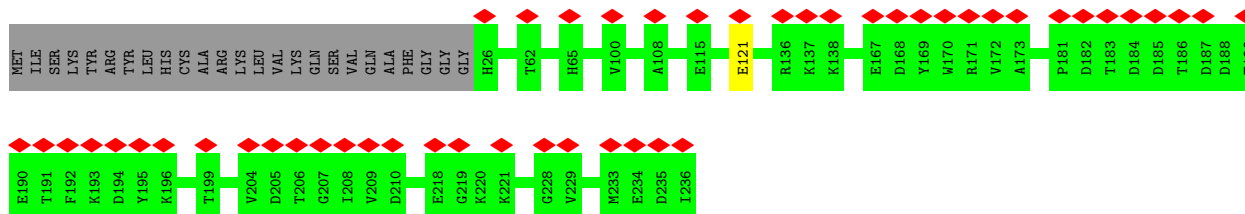
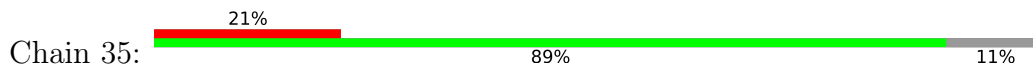

- Molecule 59: NADH dehydrogenase [ubiquinone] 1 beta subcomplex subunit 8, mitochondrial

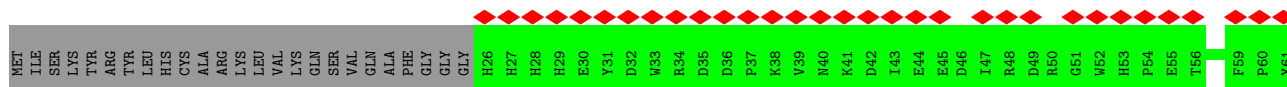
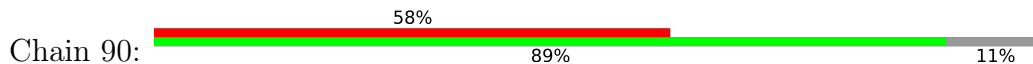



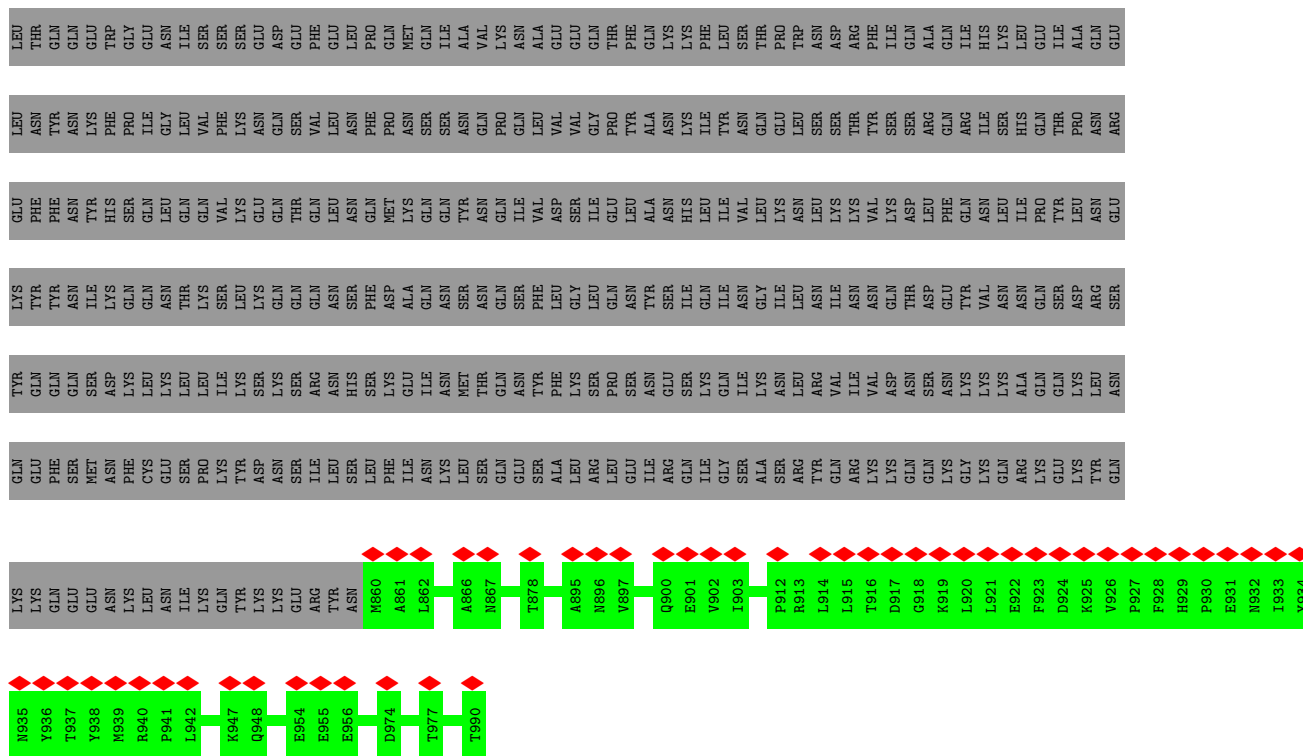

● Molecule 60: CTF/NF-I domain-containing protein

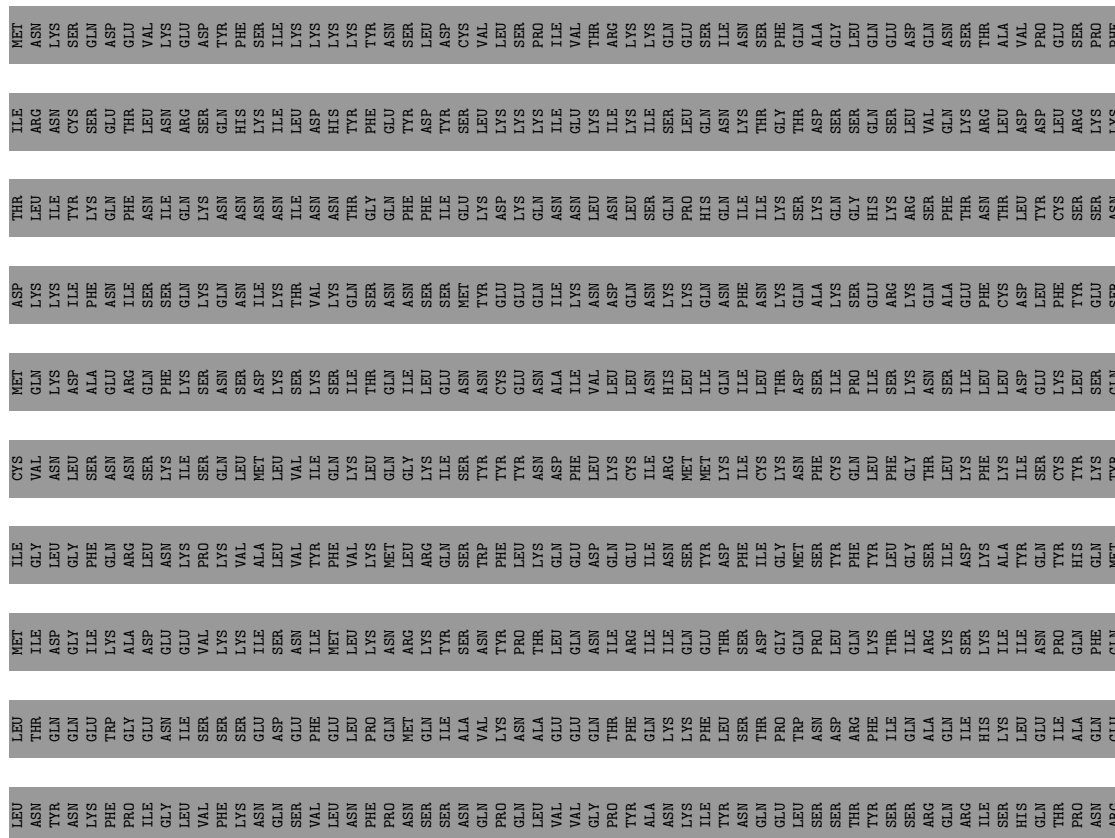



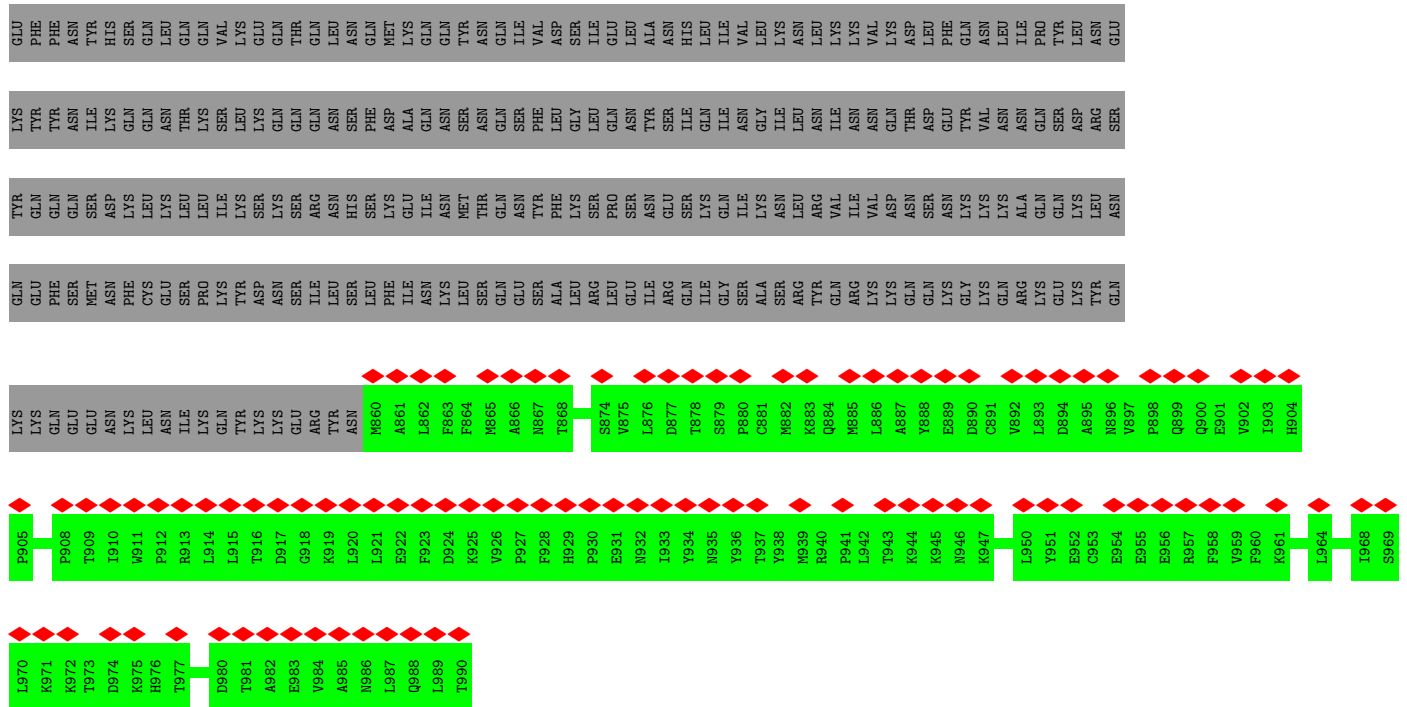

● Molecule 60: CTF/NF-I domain-containing protein

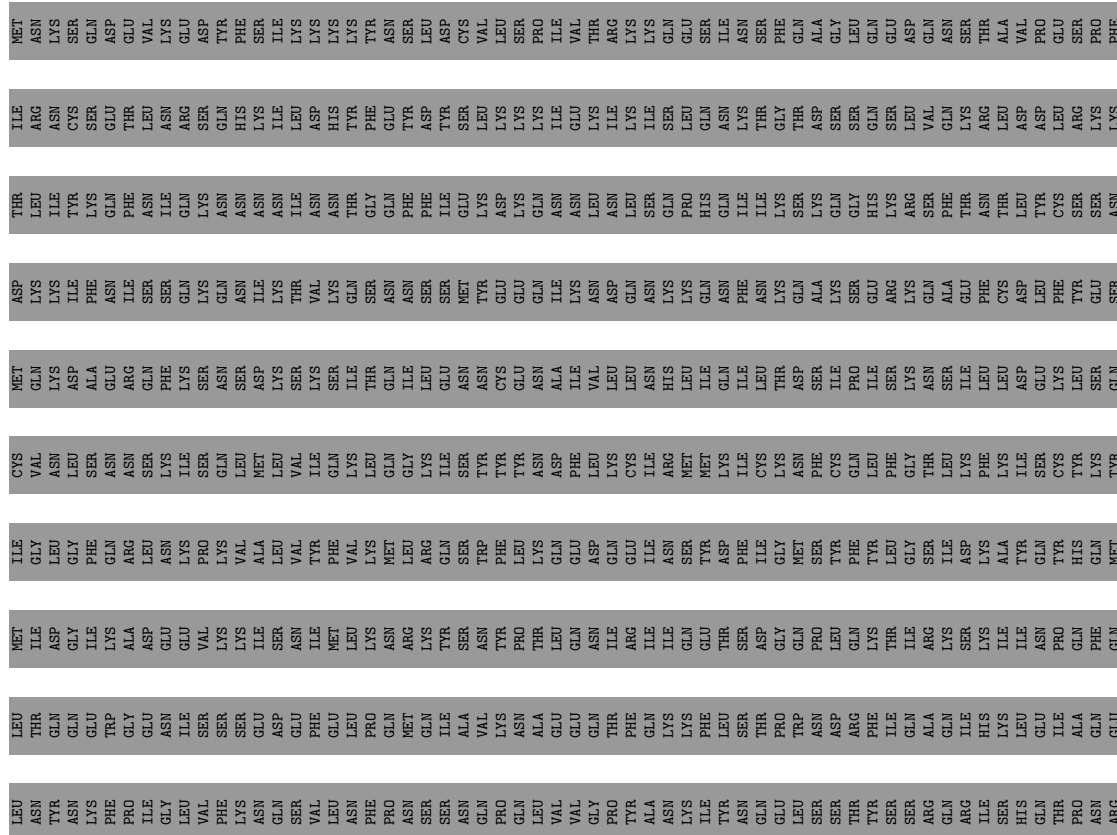



GLN  
GLU  
PHE  
SER  
MET  
ASN  
PHE  
CYS  
GLU  
SER  
PRO  
TYR  
ASP  
ASN  
SER  
ILE  
LEU  
SER  
LEU  
PHE  
ILE  
ASN  
LYS  
LEU  
SER  
GLN  
SER  
ALA  
LEU  
ARG  
LEU  
ILE  
ARG  
GLN  
ILE  
GLY  
SER  
ALA  
SER  
ARG  
TYR  
GLN  
ARG  
LYS  
GLN  
GLN  
LYS  
GLY  
GLN  
GLN  
ARG  
LYS  
TYR

LYS  
LYS  
GLN  
GLU  
GLU  
ASN  
LYS  
LEU  
ASN  
LYS  
GLN  
TYR  
LYS  
LYS  
GLU  
ARG  
TYR  
ASN  
R960  
R990

- Molecule 61: Oxoglutarate/malate translocator protein, putative

Chain 37:  14% 100%

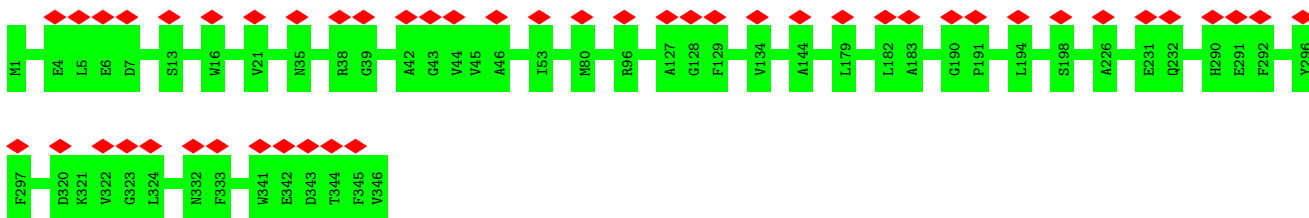

- Molecule 61: Oxoglutarate/malate translocator protein, putative

Chain 92:  63% 100%

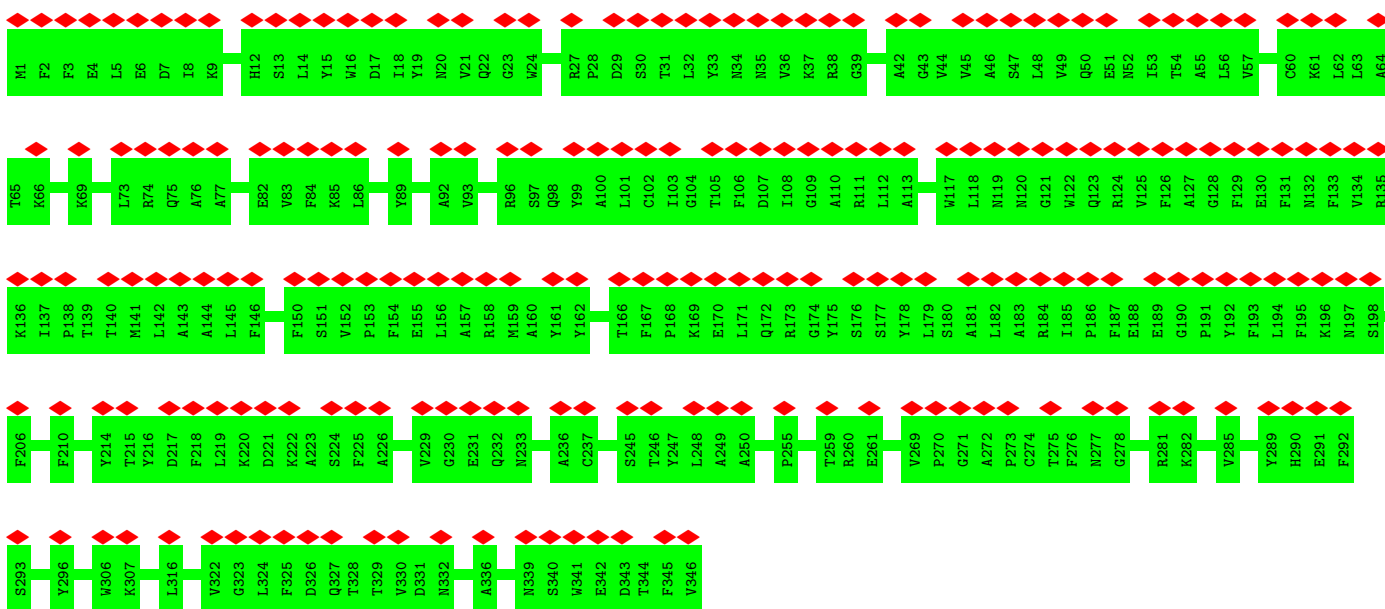

- Molecule 61: Oxoglutarate/malate translocator protein, putative

Chain m1:  100%

There are no outlier residues recorded for this chain.

- Molecule 61: Oxoglutarate/malate translocator protein, putative

Chain M1:  100%

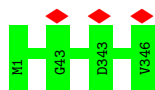

• Molecule 62: 2-oxoglutarate/malate carrier protein



• Molecule 62: 2-oxoglutarate/malate carrier protein

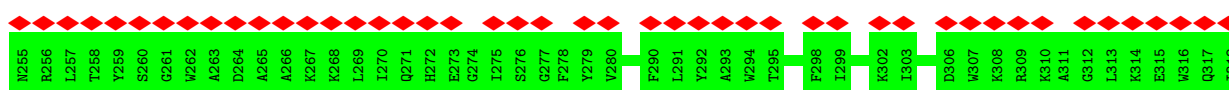
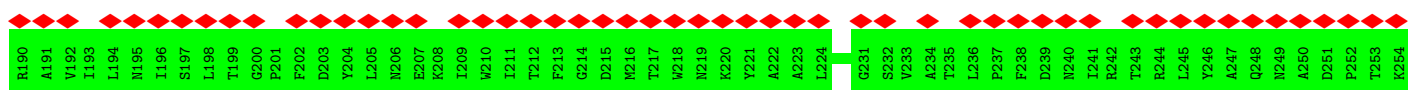
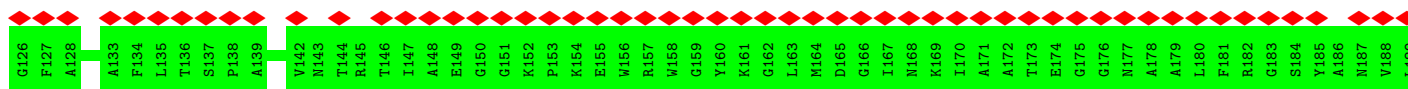
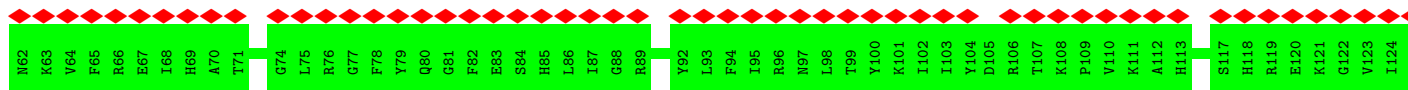
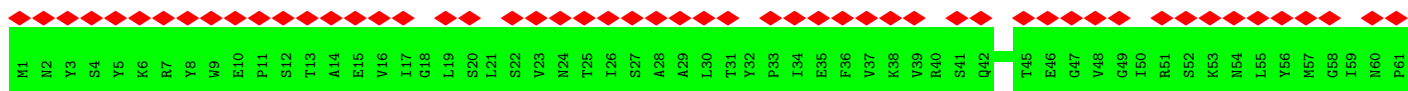
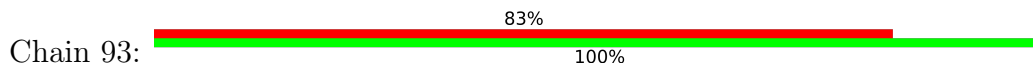

• Molecule 62: 2-oxoglutarate/malate carrier protein

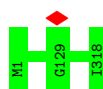

• Molecule 62: 2-oxoglutarate/malate carrier protein



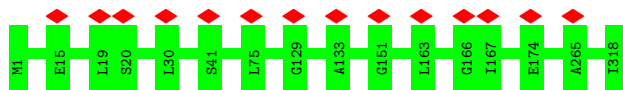

• Molecule 63: Carrier protein

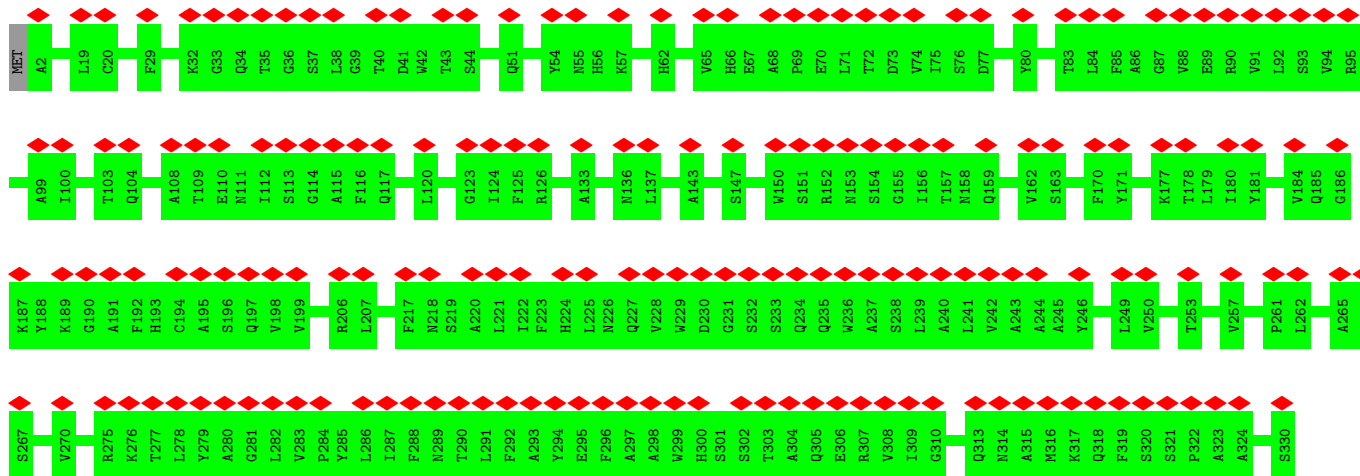

• Molecule 63: Carrier protein

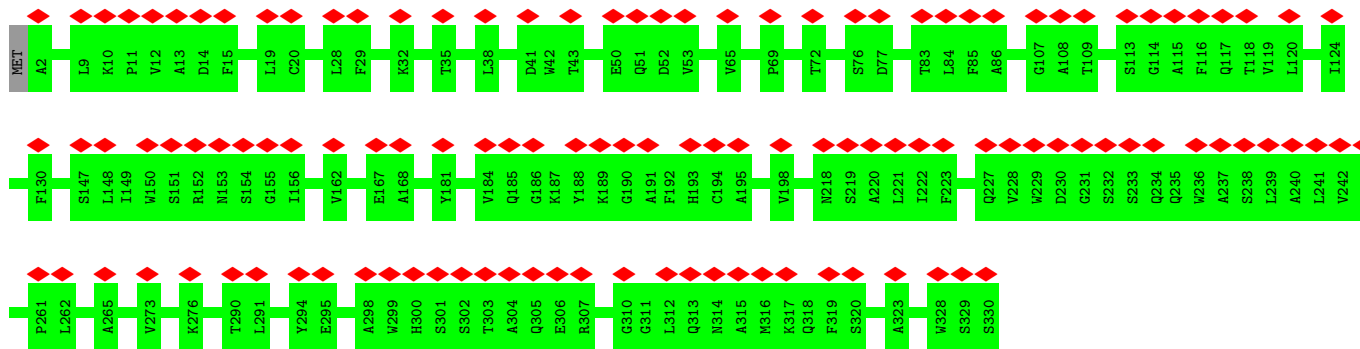

• Molecule 63: Carrier protein

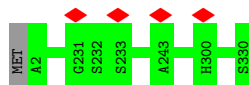

• Molecule 63: Carrier protein



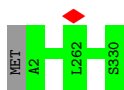

- Molecule 64: Tim10/DDP family zinc finger protein

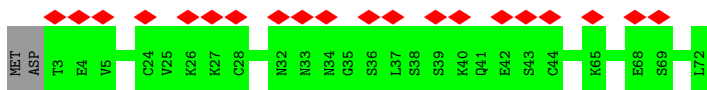

- Molecule 64: Tim10/DDP family zinc finger protein

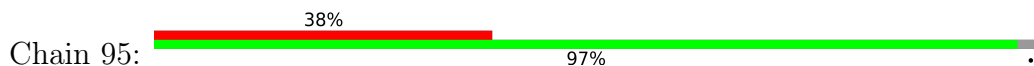

- Molecule 64: Tim10/DDP family zinc finger protein



- Molecule 64: Tim10/DDP family zinc finger protein



- Molecule 65: Zf-Tim10\_DDP domain-containing protein

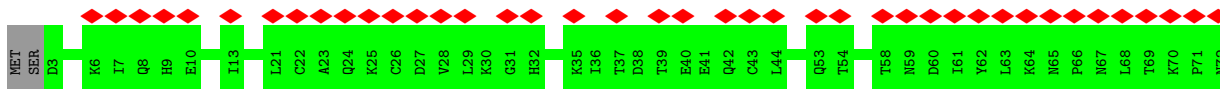

- Molecule 65: Zf-Tim10\_DDP domain-containing protein

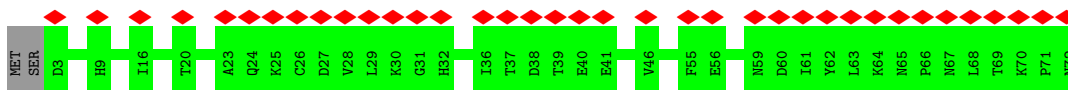

- Molecule 65: Zf-Tim10\_DDP domain-containing protein

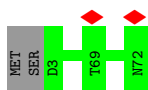

- Molecule 65: Zf-Tim10\_DDP domain-containing protein



- Molecule 66: Zf-Tim10\_DDP domain-containing protein

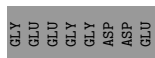
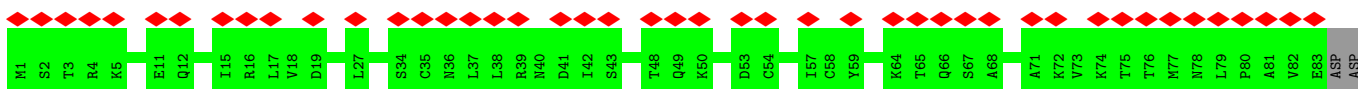
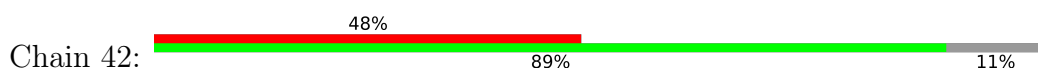

- Molecule 66: Zf-Tim10\_DDP domain-containing protein

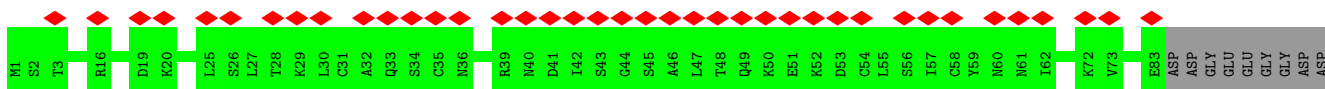
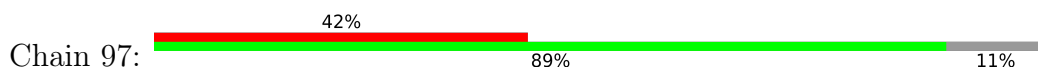

- Molecule 66: Zf-Tim10\_DDP domain-containing protein

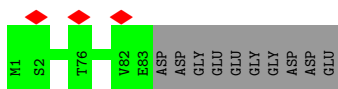

- Molecule 66: Zf-Tim10\_DDP domain-containing protein

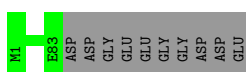
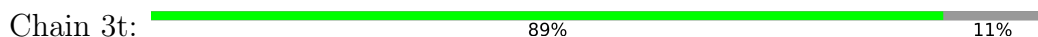

- Molecule 67: Transposase

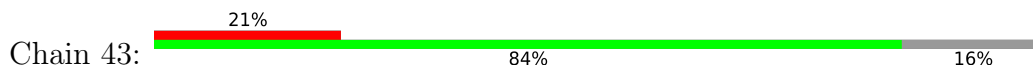

• Molecule 67: Transposase

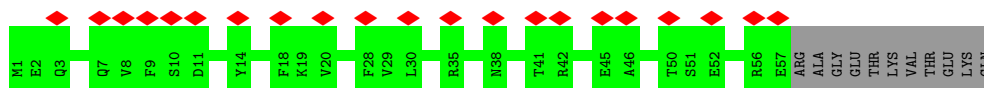
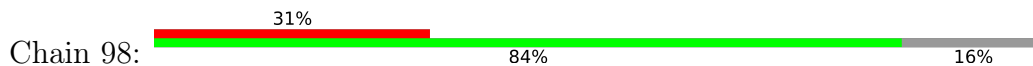

• Molecule 67: Transposase

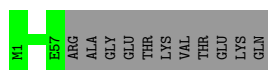
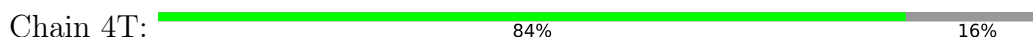

• Molecule 67: Transposase

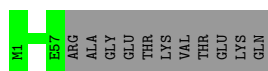
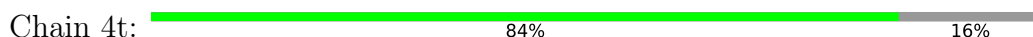

• Molecule 68: Cullin domain-containing protein

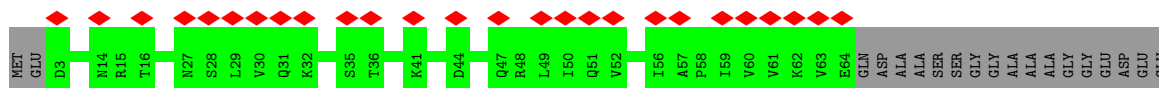
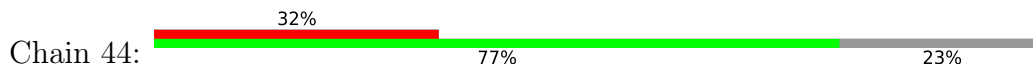

• Molecule 68: Cullin domain-containing protein

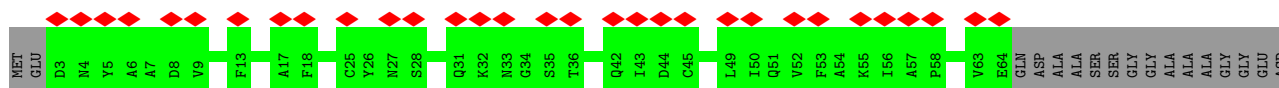
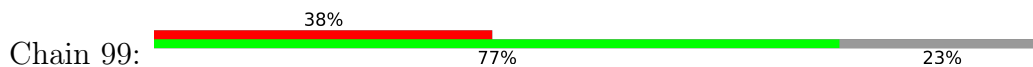

• Molecule 68: Cullin domain-containing protein

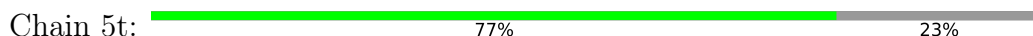



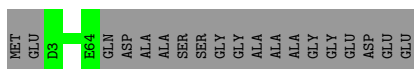

- Molecule 68: Cullin domain-containing protein

Chain 5T: 77% 23%

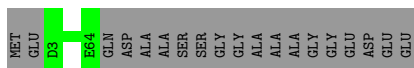

- Molecule 69: Ymf58

Chain 4L: 9% 100%

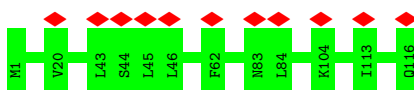

- Molecule 69: Ymf58

Chain 4L: 100%



- Molecule 70: Ymf57

Chain 5b: 8% 100%



- Molecule 70: Ymf57

Chain 5B: 6% 100%

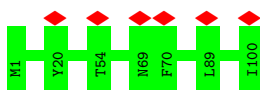

- Molecule 71: Transmembrane protein, putative

Chain a1: 26% 99%

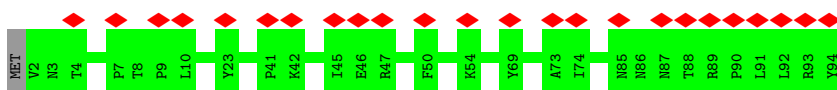

- Molecule 71: Transmembrane protein, putative

Chain A1: 99%



- Molecule 72: Ribosomal protein L51/S25/CI-B8 domain protein

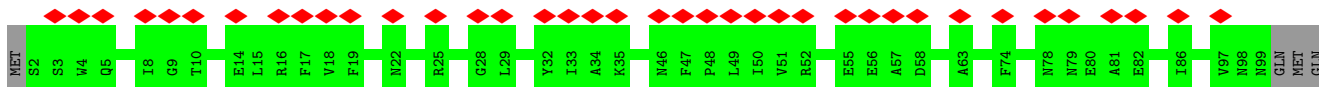

- Molecule 72: Ribosomal protein L51/S25/CI-B8 domain protein

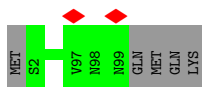

- Molecule 73: Transmembrane protein, putative

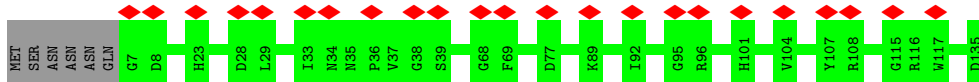

- Molecule 73: Transmembrane protein, putative

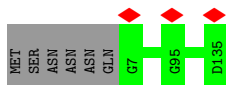

- Molecule 74: ETC complex I subunit motif protein

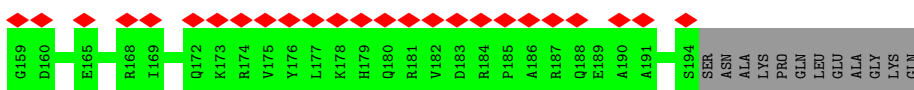
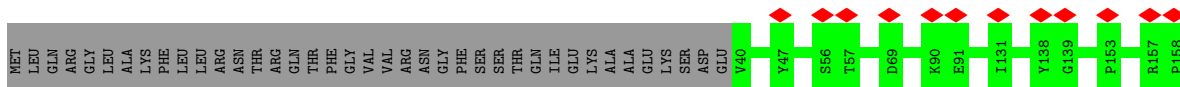
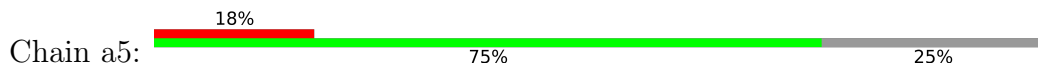

- Molecule 74: ETC complex I subunit motif protein

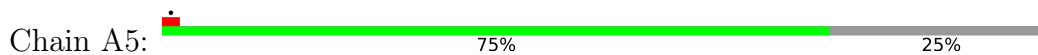

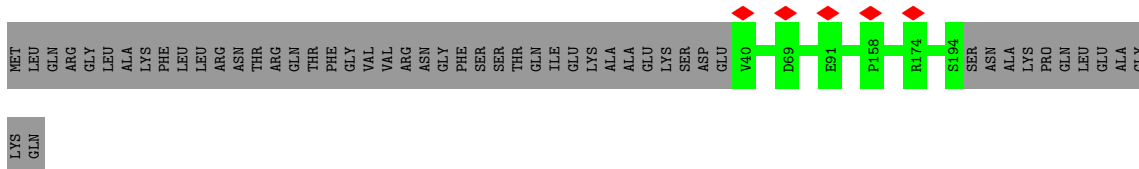

• Molecule 75: NADH dehydrogenase, putative

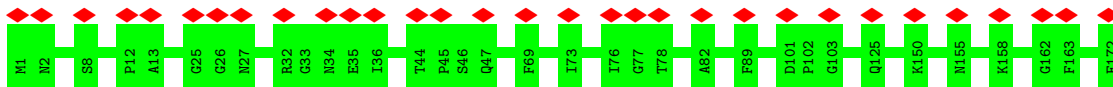

• Molecule 75: NADH dehydrogenase, putative



There are no outlier residues recorded for this chain.

• Molecule 76: 37S ribosomal protein S25, mitochondrial

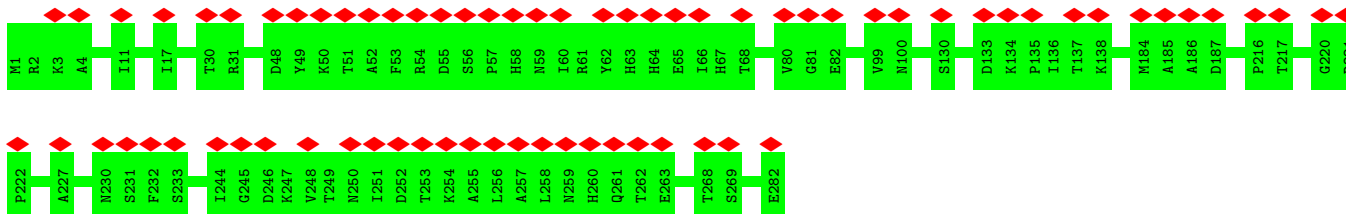

• Molecule 76: 37S ribosomal protein S25, mitochondrial

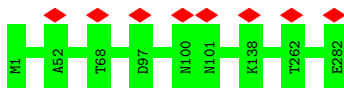

• Molecule 77: CX9C domain-containing protein

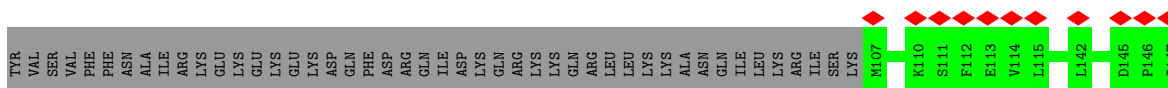

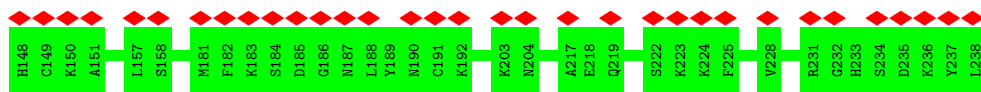

• Molecule 77: CX9C domain-containing protein

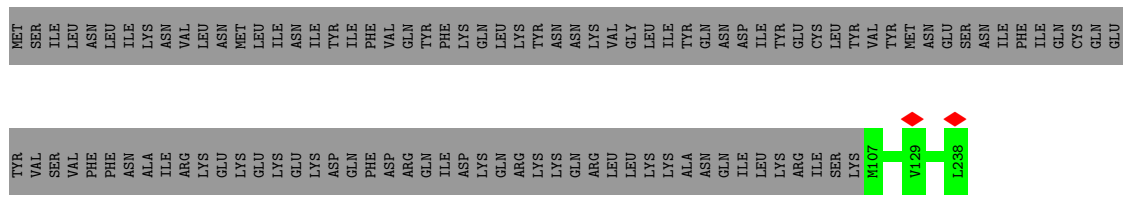

• Molecule 78: NAD-dependent epimerase/dehydratase family protein

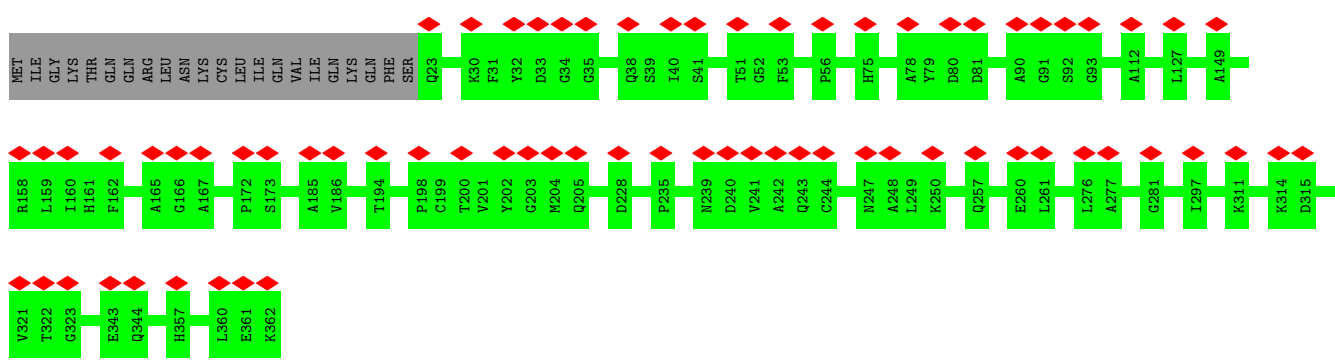

• Molecule 78: NAD-dependent epimerase/dehydratase family protein

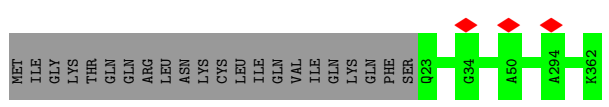

• Molecule 79: Acyl carrier protein

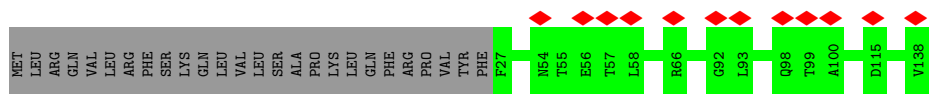
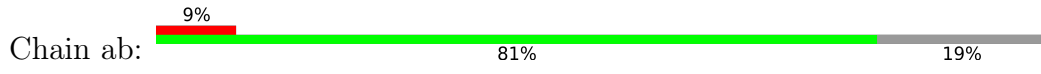

• Molecule 79: Acyl carrier protein

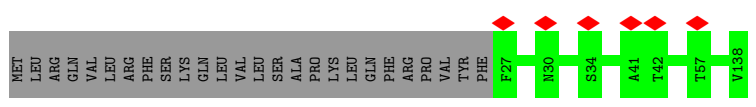
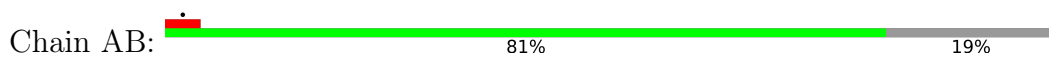

• Molecule 80: Acyl carrier protein

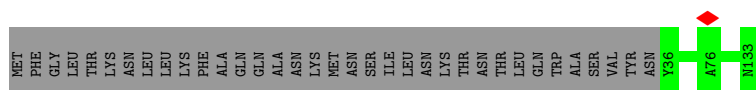
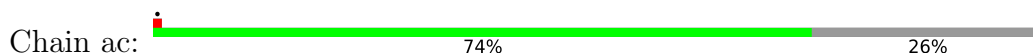

• Molecule 80: Acyl carrier protein

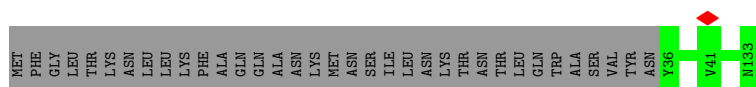
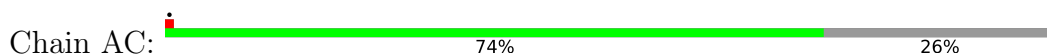

• Molecule 81: NADH dehydrogenase [ubiquinone] 1 alpha subcomplex subunit 12

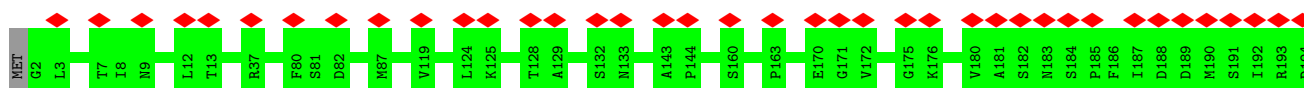

• Molecule 81: NADH dehydrogenase [ubiquinone] 1 alpha subcomplex subunit 12

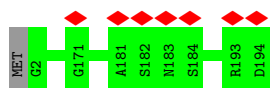

• Molecule 82: NDUA13

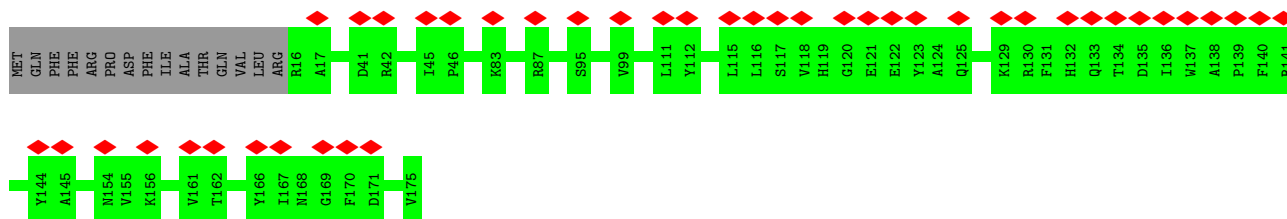
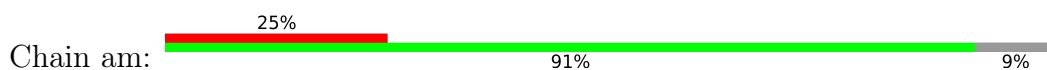

• Molecule 82: NDUA13

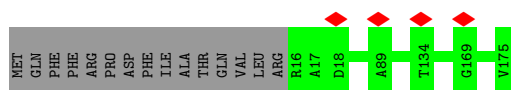

• Molecule 83: Transmembrane protein, putative

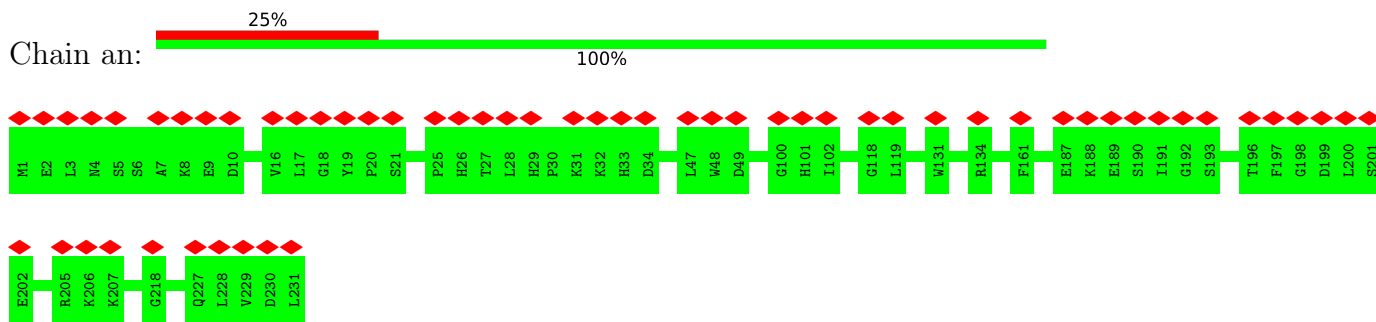

• Molecule 83: Transmembrane protein, putative

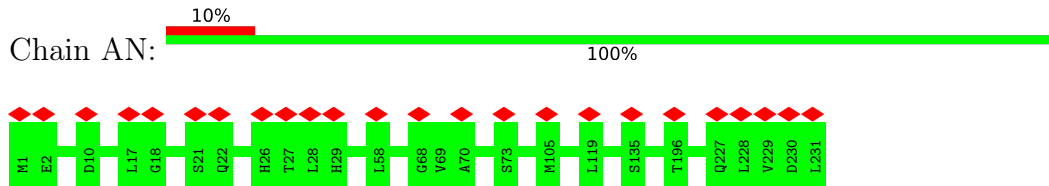

• Molecule 84: NDUB2

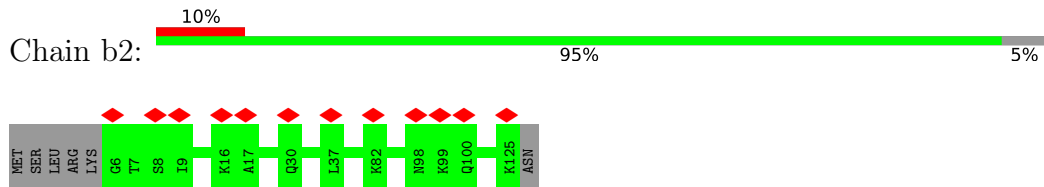

• Molecule 84: NDUB2

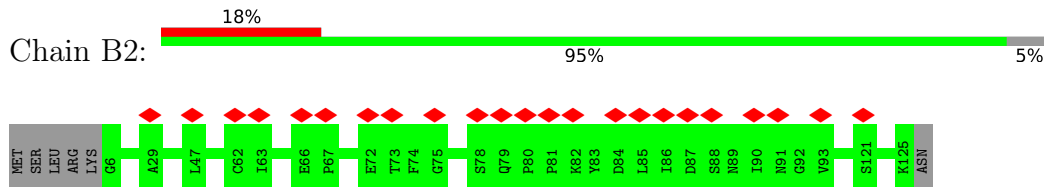

• Molecule 85: Transmembrane protein, putative

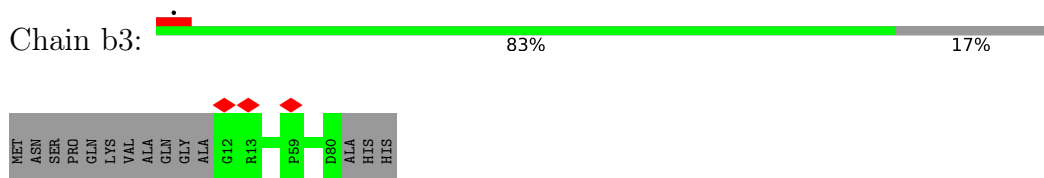

• Molecule 85: Transmembrane protein, putative

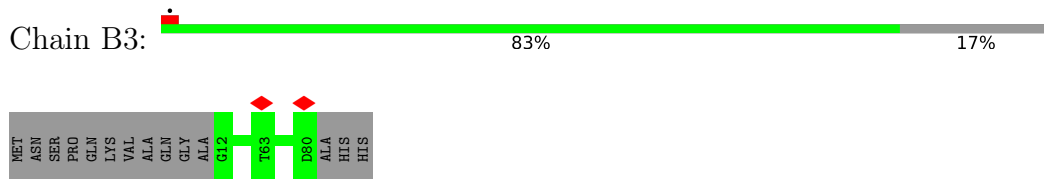

• Molecule 86: NDUB4

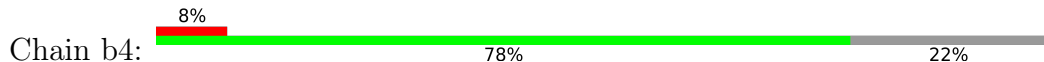

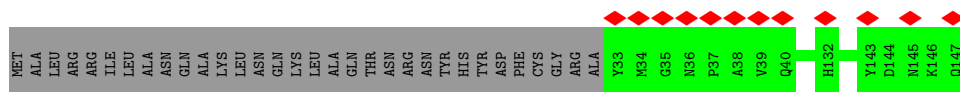

• Molecule 86: NDUB4

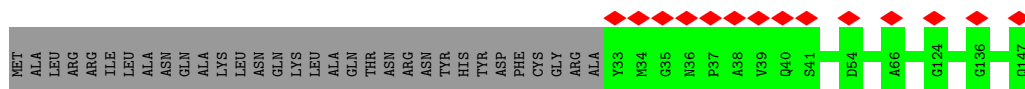
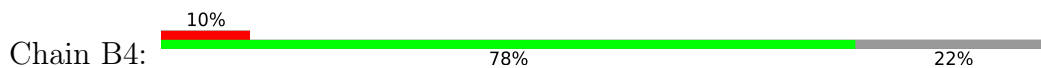

• Molecule 87: NDUB6

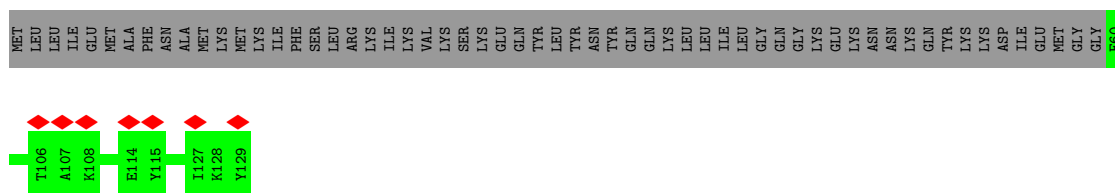

• Molecule 87: NDUB6

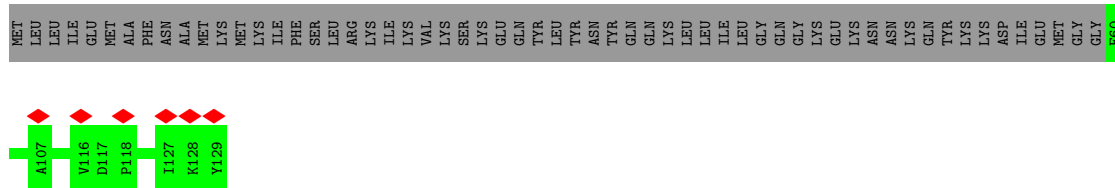

• Molecule 88: CHCH domain-containing protein

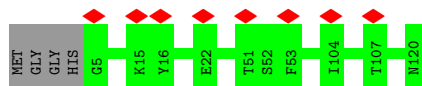

• Molecule 88: CHCH domain-containing protein

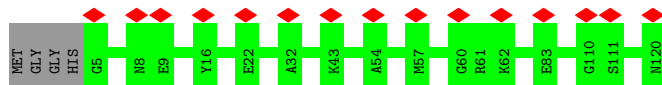

• Molecule 89: NDUB8

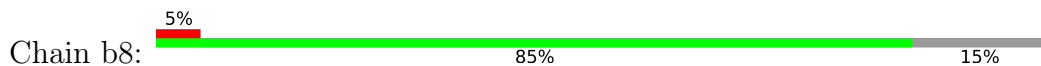

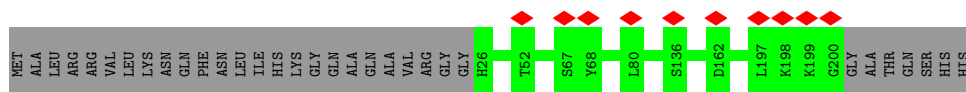

- Molecule 89: NDUB8

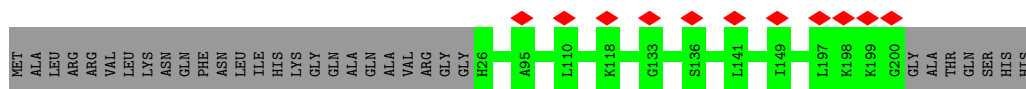
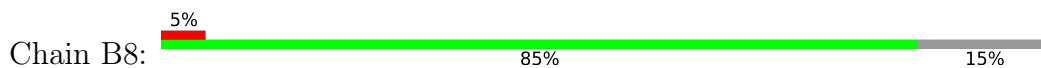

- Molecule 90: NADH dehydrogenase [ubiquinone] 1 alpha subcomplex subunit 10, mitochondrial

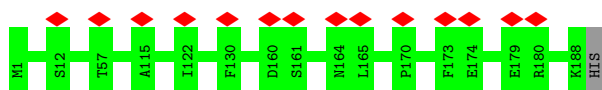

- Molecule 90: NADH dehydrogenase [ubiquinone] 1 alpha subcomplex subunit 10, mitochondrial

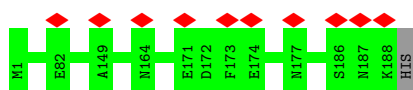

- Molecule 91: NDUB10

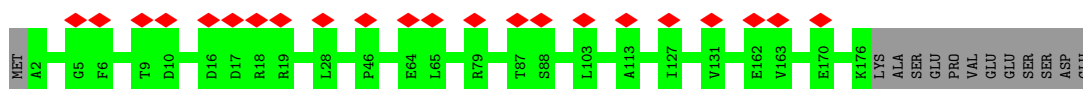

- Molecule 91: NDUB10

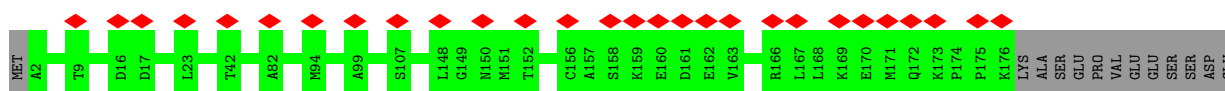

- Molecule 92: Transmembrane protein, putative

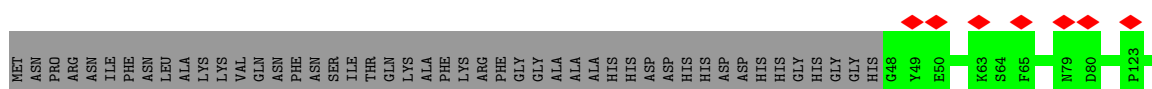
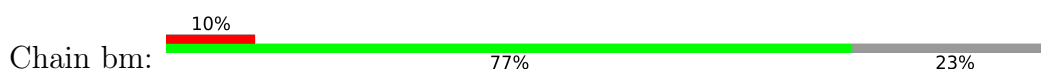



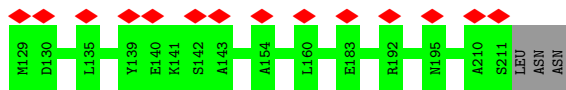

• Molecule 92: Transmembrane protein, putative

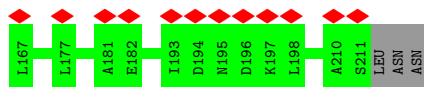
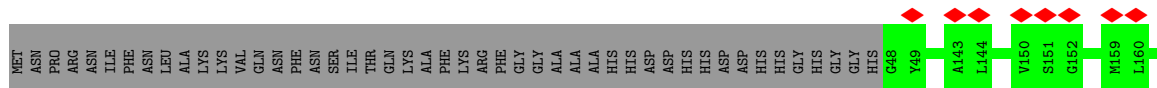
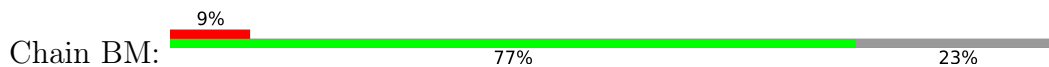

• Molecule 93: Complex I-MNLL

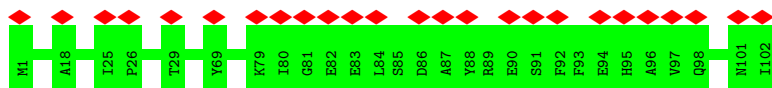

• Molecule 93: Complex I-MNLL

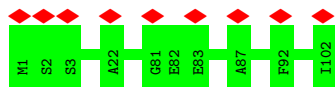

• Molecule 94: 2 iron, 2 sulfur cluster-binding protein

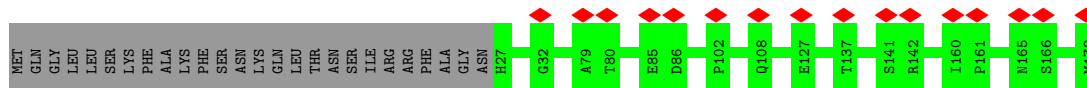
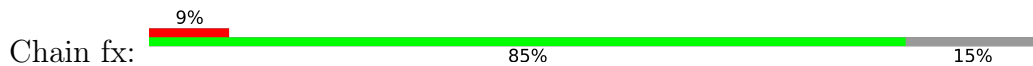

• Molecule 94: 2 iron, 2 sulfur cluster-binding protein

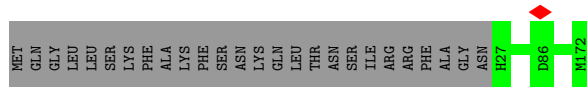
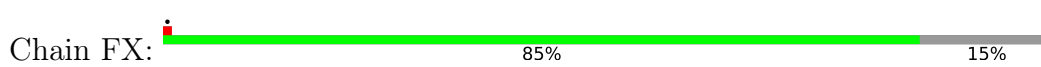

• Molecule 95: Gamma-carbonic anhydrase

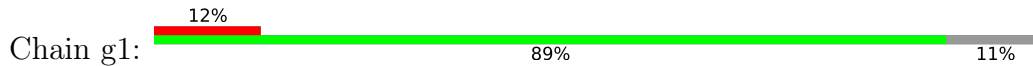

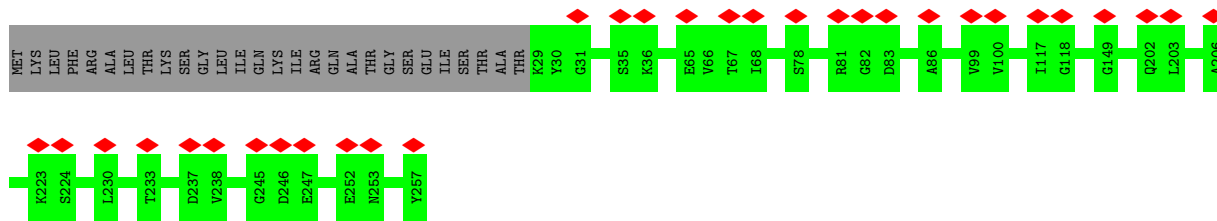

- Molecule 95: Gamma-carbonic anhydrase

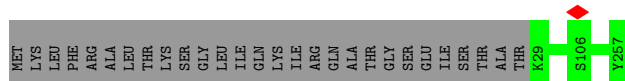

- Molecule 96: Gamma-carbonic anhydrase



- Molecule 96: Gamma-carbonic anhydrase

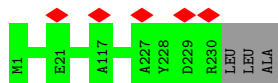

- Molecule 97: Transcription factor apfi protein, putative

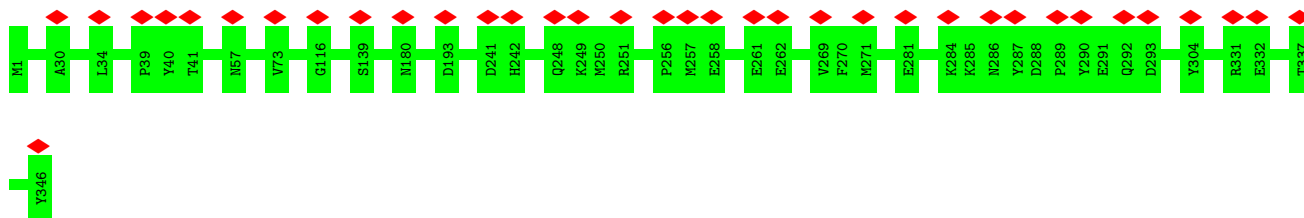

- Molecule 97: Transcription factor apfi protein, putative



- Molecule 98: DnaJ domain protein

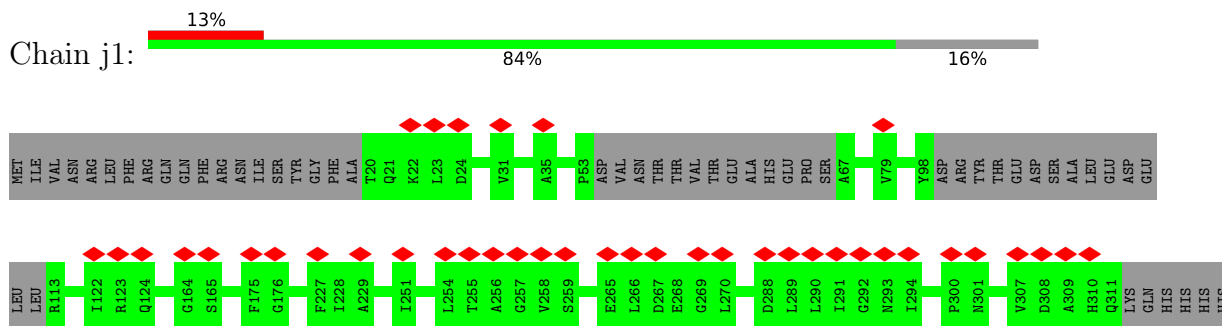

• Molecule 98: DnaJ domain protein

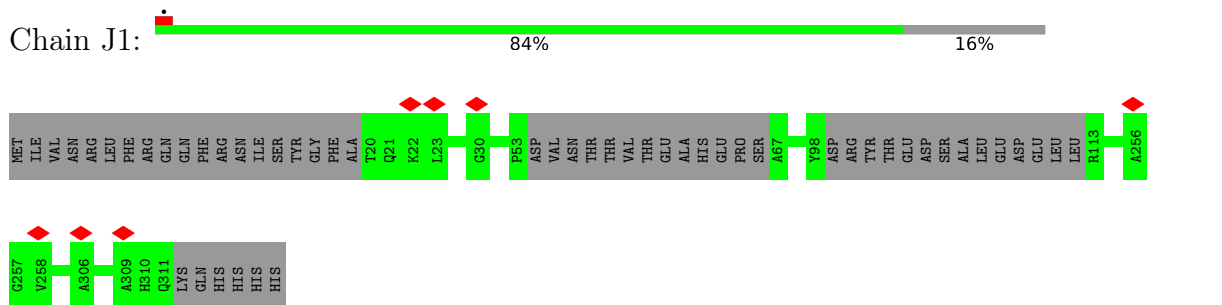

• Molecule 99: NADH-ubiquinone oxidoreductase chain 1

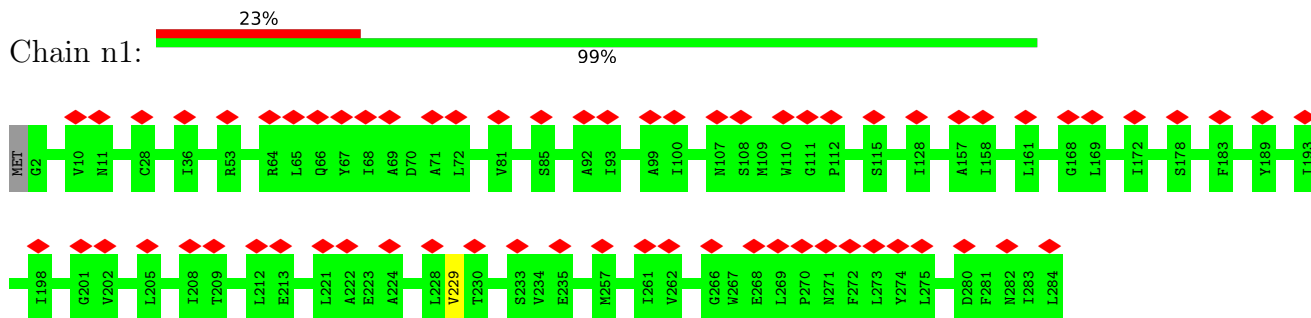

• Molecule 99: NADH-ubiquinone oxidoreductase chain 1

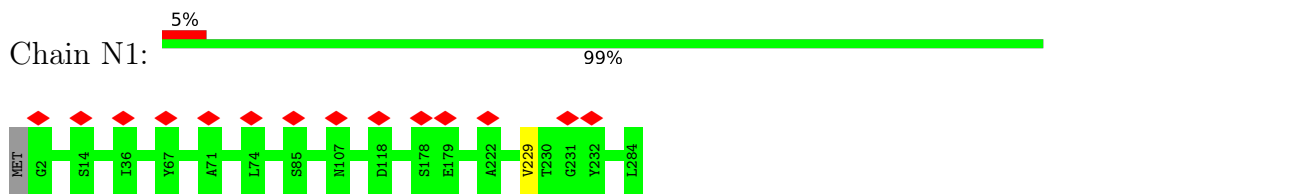

• Molecule 100: Ymf65

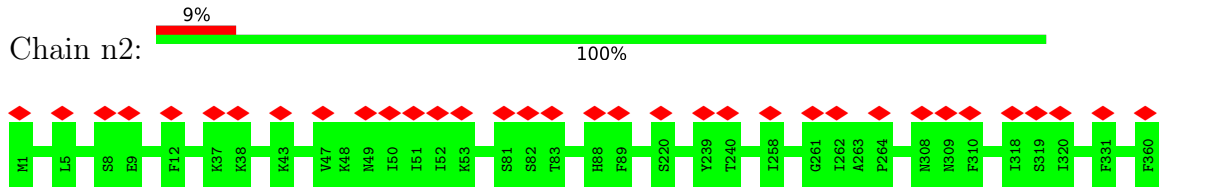

• Molecule 100: Ymf65

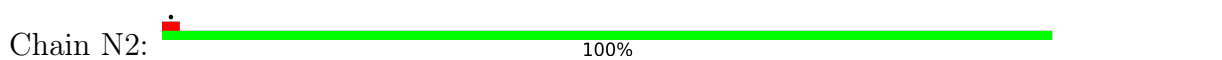

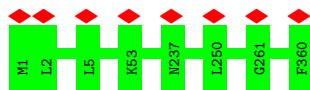

- Molecule 101: NADH-ubiquinone oxidoreductase chain 3

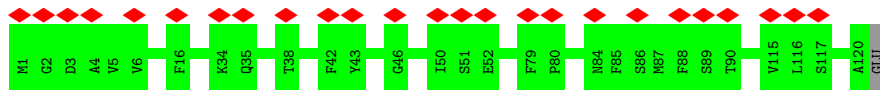

- Molecule 101: NADH-ubiquinone oxidoreductase chain 3

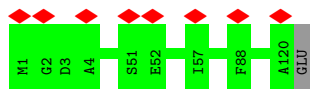

- Molecule 102: NADH-ubiquinone oxidoreductase chain 4

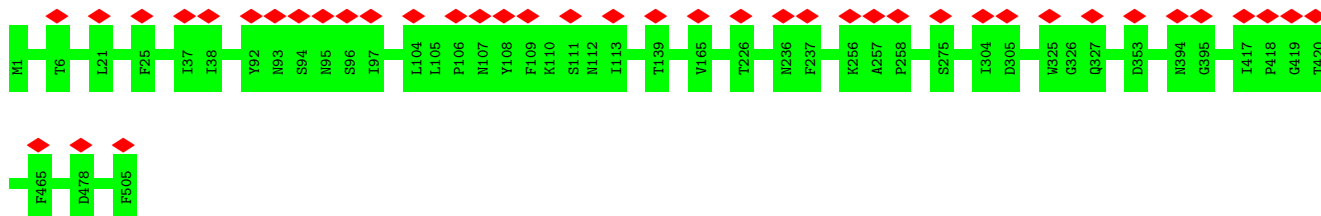

- Molecule 102: NADH-ubiquinone oxidoreductase chain 4

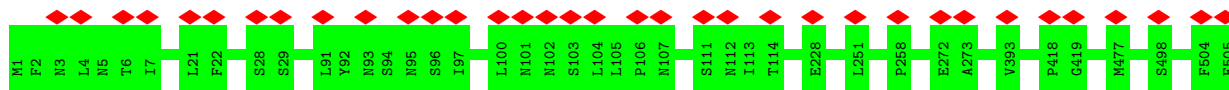

- Molecule 103: NADH dehydrogenase subunit 5

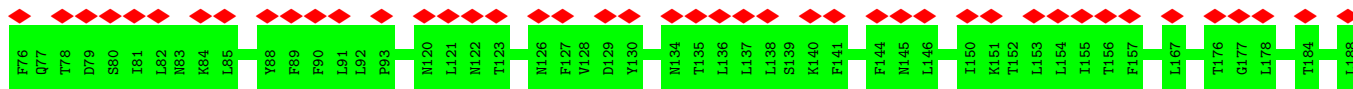
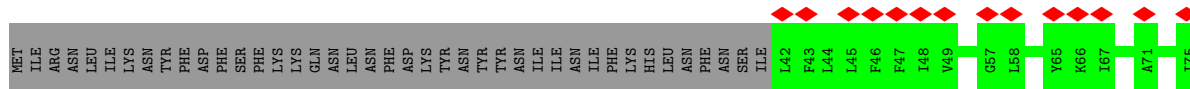

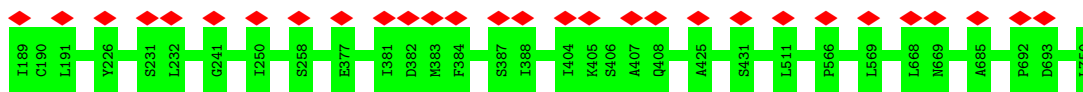

- Molecule 103: NADH dehydrogenase subunit 5

Chain N5: 9% 95% 5%

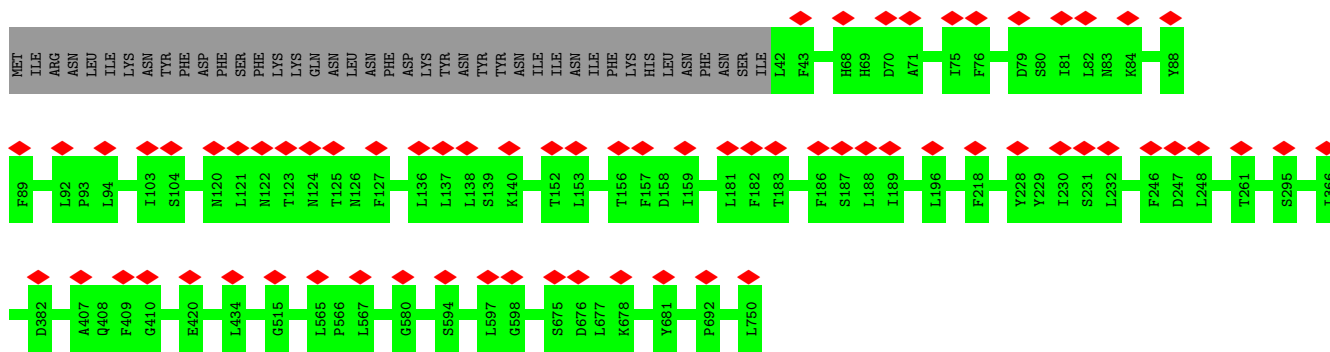

- Molecule 104: Ymf62

Chain n6: 21% 100%

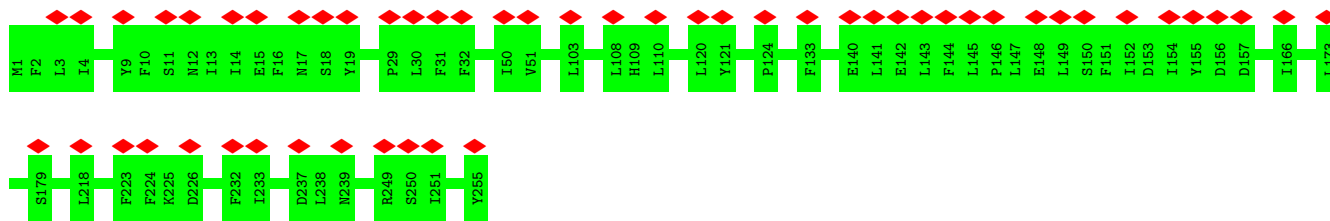

- Molecule 104: Ymf62

Chain N6: 5% 100%

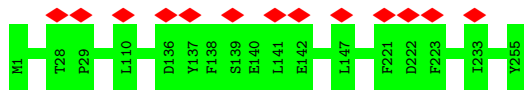

- Molecule 105: Transmembrane protein, putative

Chain p1: 6% 92% 8%

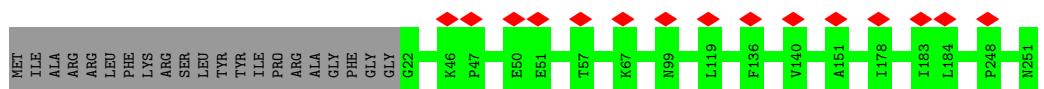

- Molecule 105: Transmembrane protein, putative

Chain P1: 6% 92% 8%

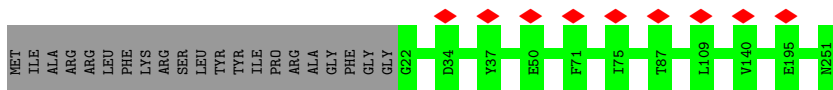

• Molecule 106: NDUPH2

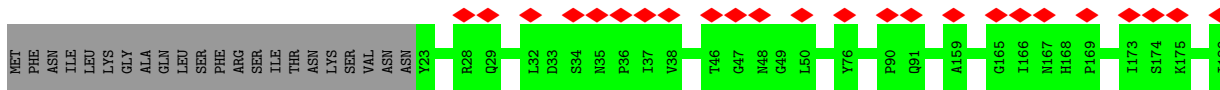
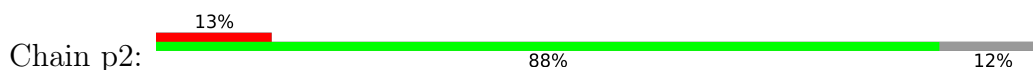

• Molecule 106: NDUPH2

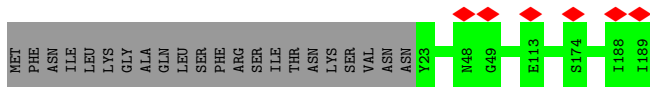
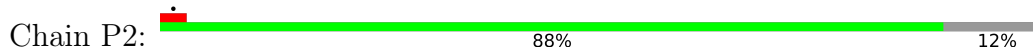

• Molecule 107: M16 family peptidase, putative

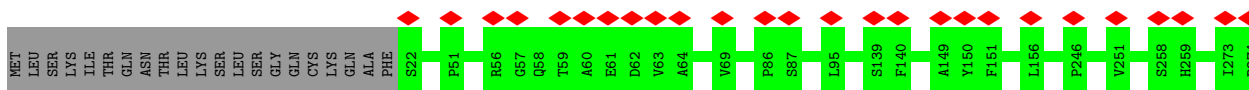

• Molecule 107: M16 family peptidase, putative

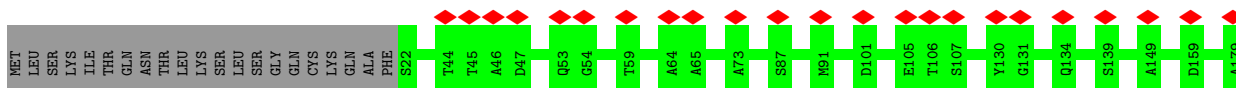

• Molecule 107: M16 family peptidase, putative

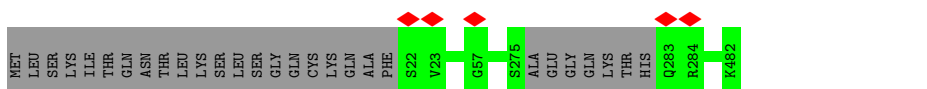

• Molecule 107: M16 family peptidase, putative

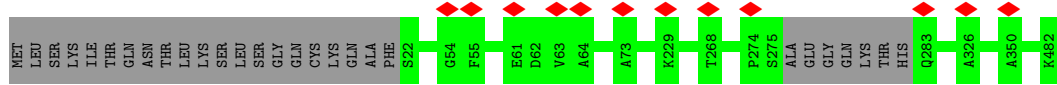

• Molecule 108: Peptidase M16 inactive domain protein

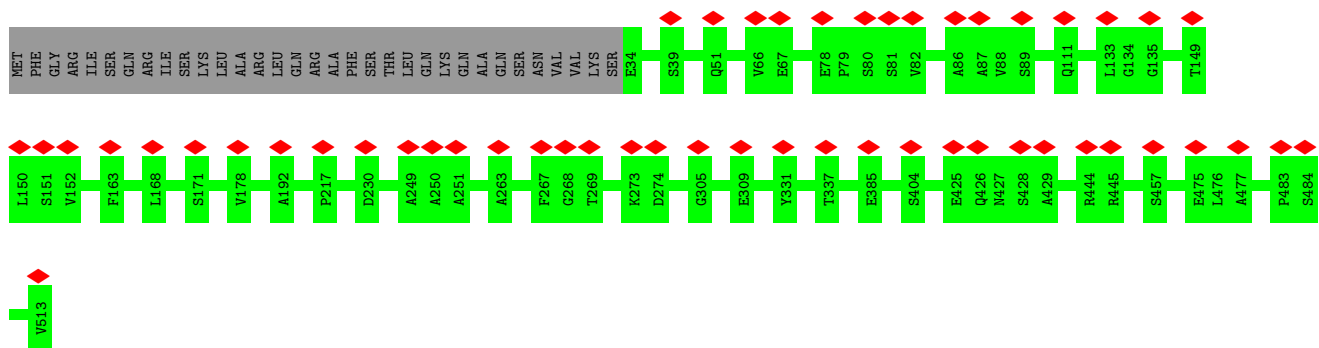

• Molecule 108: Peptidase M16 inactive domain protein

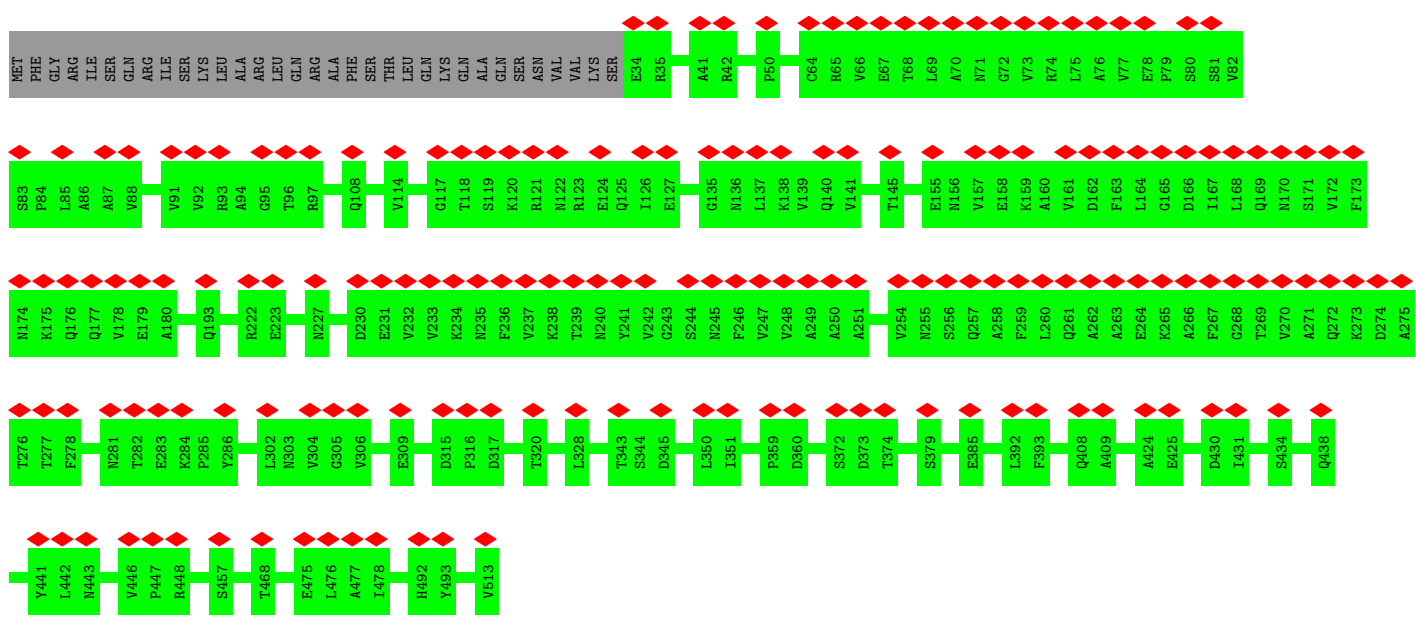

• Molecule 108: Peptidase M16 inactive domain protein

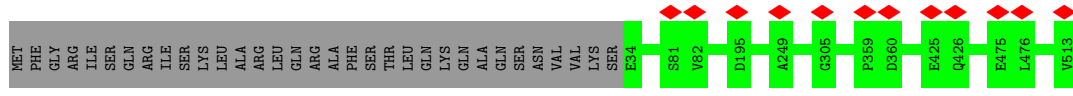

• Molecule 108: Peptidase M16 inactive domain protein

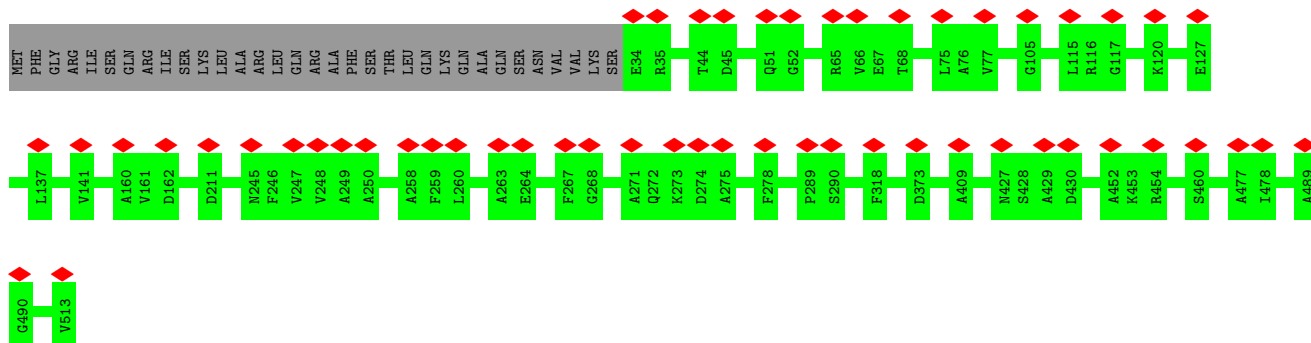

• Molecule 109: Apocytochrome b

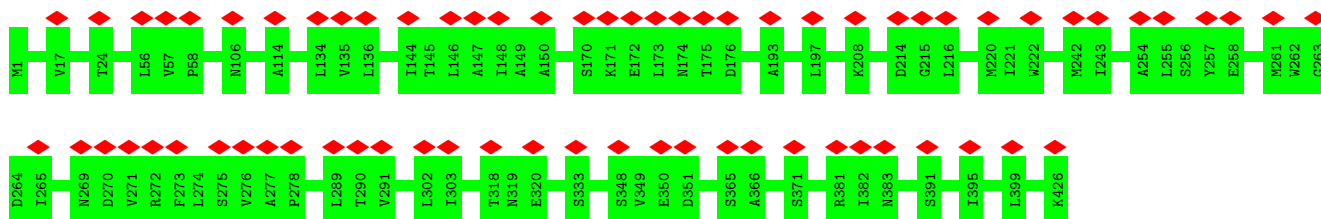

• Molecule 109: Apocytochrome b

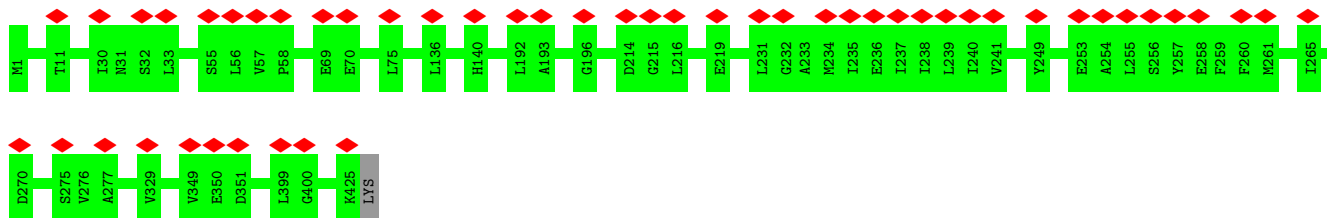

• Molecule 109: Apocytochrome b



• Molecule 109: Apocytochrome b





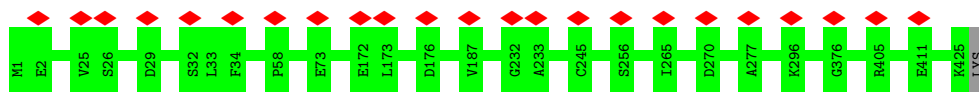

- Molecule 110: Cytochrome protein c1

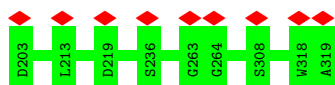
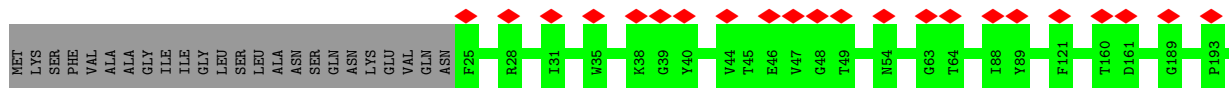

- Molecule 110: Cytochrome protein c1

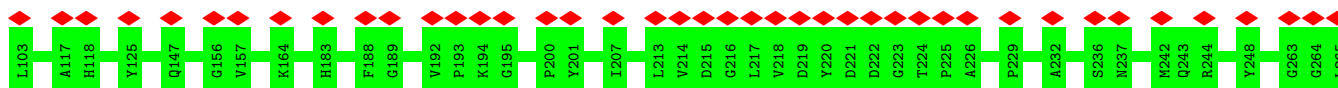
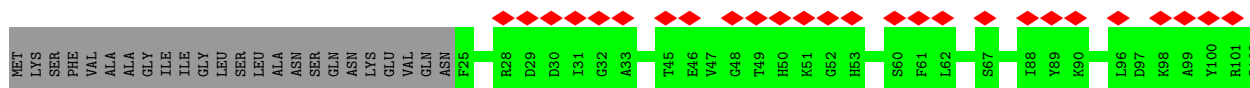

- Molecule 110: Cytochrome protein c1

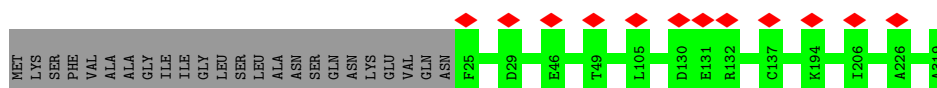

- Molecule 110: Cytochrome protein c1

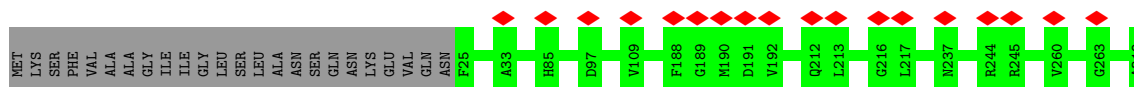
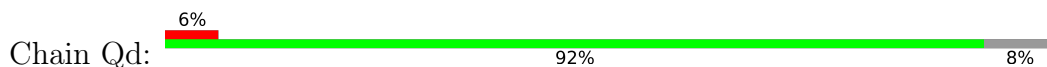

- Molecule 111: Rieske iron-sulfur protein, ubiquinol-cytochrome C reductase iron-sulfur sub-unit

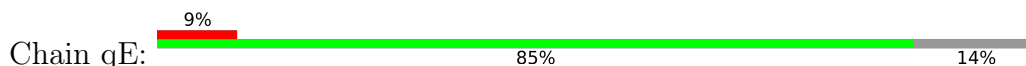

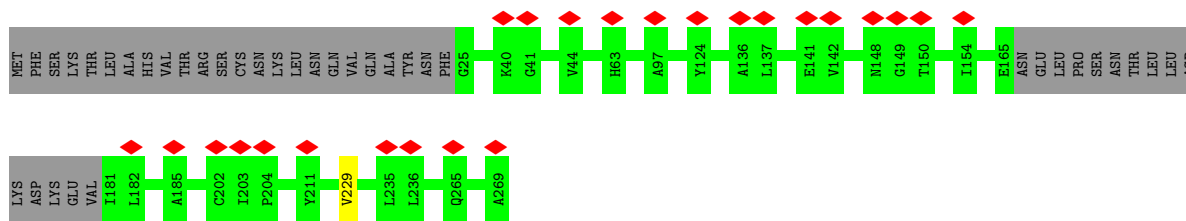

- Molecule 111: Rieske iron-sulfur protein, ubiquinol-cytochrome C reductase iron-sulfur subunit

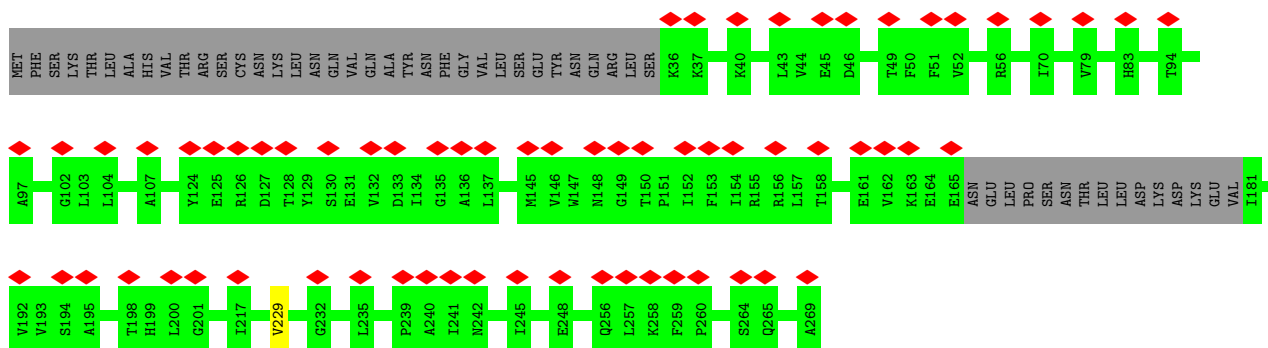
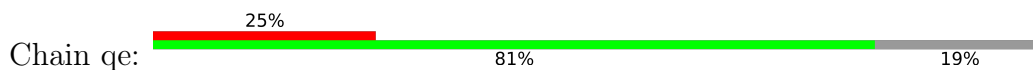

- Molecule 111: Rieske iron-sulfur protein, ubiquinol-cytochrome C reductase iron-sulfur subunit

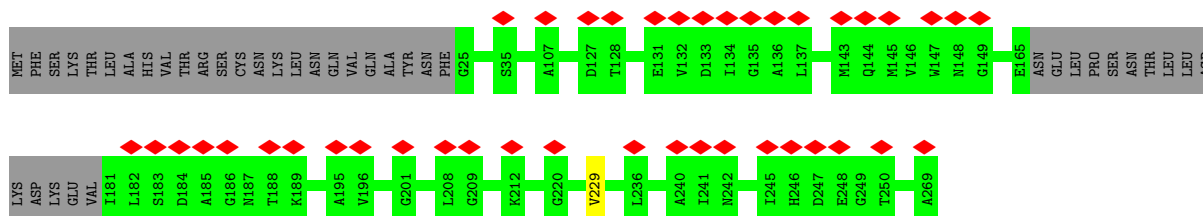
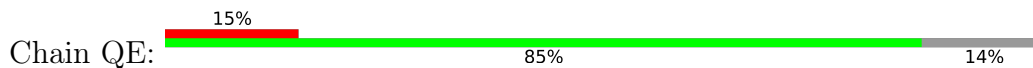

- Molecule 111: Rieske iron-sulfur protein, ubiquinol-cytochrome C reductase iron-sulfur subunit

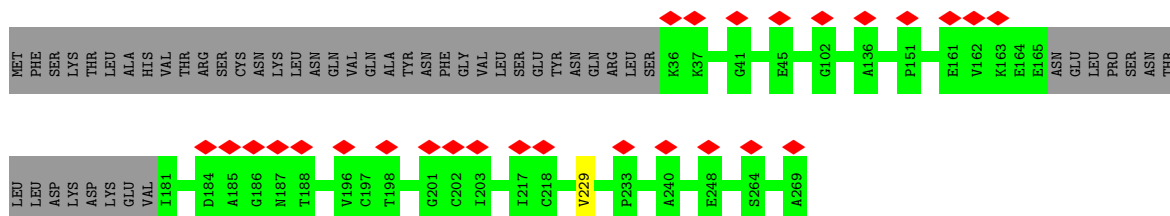
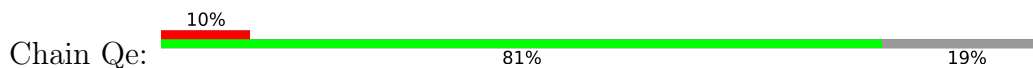

- Molecule 112: Ubiquinol-cytochrome C reductase hinge protein

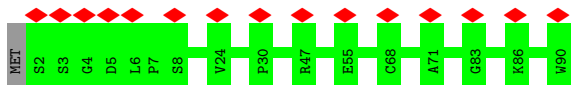

- Molecule 112: Ubiquinol-cytochrome C reductase hinge protein

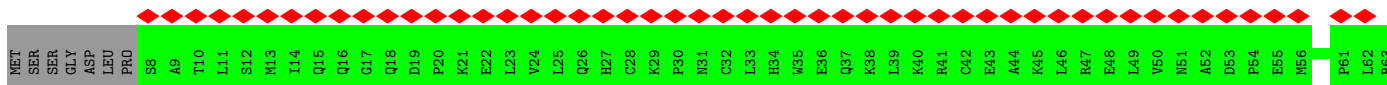
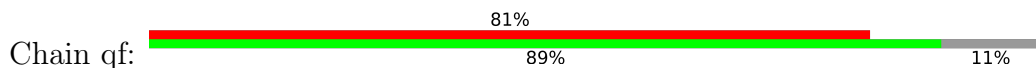

- Molecule 112: Ubiquinol-cytochrome C reductase hinge protein



- Molecule 112: Ubiquinol-cytochrome C reductase hinge protein

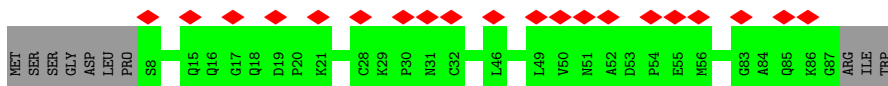
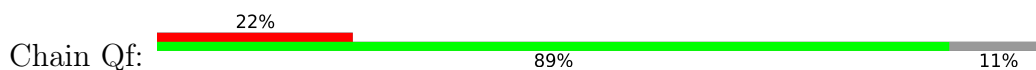

- Molecule 113: Sulphotransf domain-containing protein

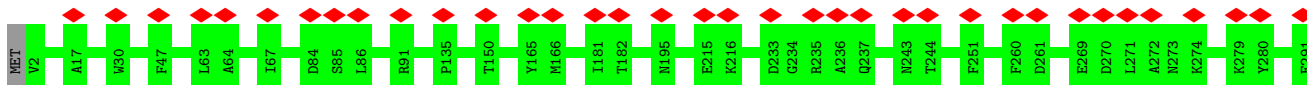

- Molecule 113: Sulphotransf domain-containing protein

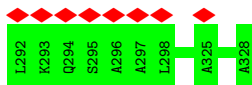

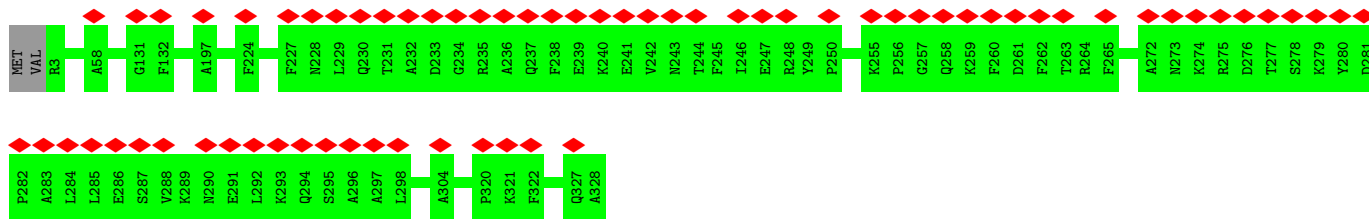

- Molecule 113: Sulphotransf domain-containing protein

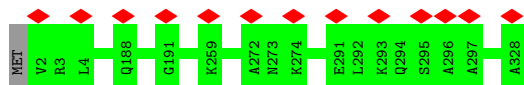

- Molecule 113: Sulphotransf domain-containing protein



- Molecule 114: Transmembrane protein, putative

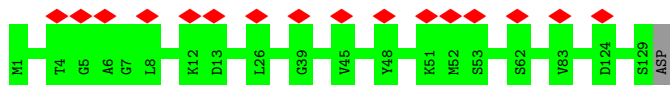

- Molecule 114: Transmembrane protein, putative



- Molecule 114: Transmembrane protein, putative

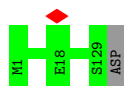

- Molecule 114: Transmembrane protein, putative



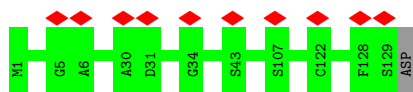

- Molecule 115: Transmembrane protein, putative

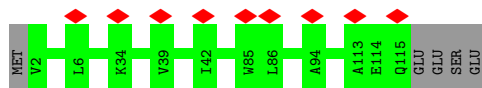

- Molecule 115: Transmembrane protein, putative

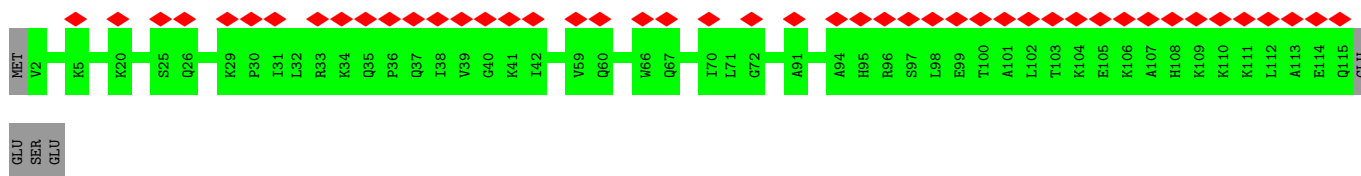
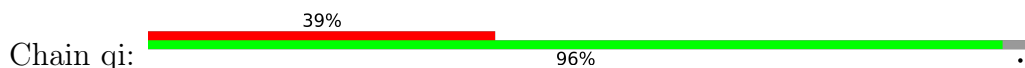

- Molecule 115: Transmembrane protein, putative

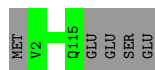

- Molecule 115: Transmembrane protein, putative

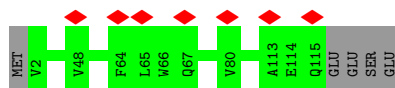

- Molecule 116: Transmembrane protein, putative

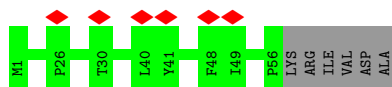
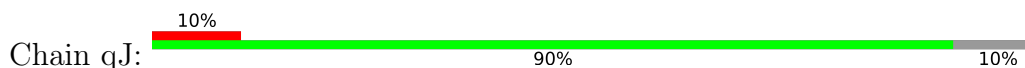

- Molecule 116: Transmembrane protein, putative



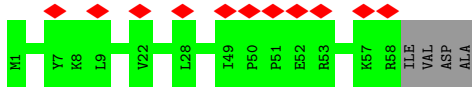

- Molecule 116: Transmembrane protein, putative

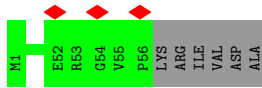
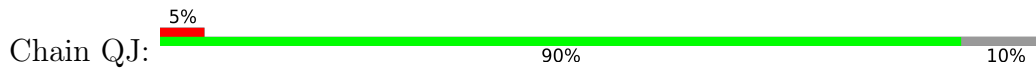

- Molecule 116: Transmembrane protein, putative

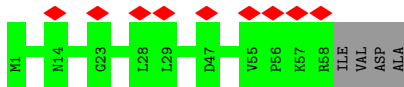

- Molecule 117: UQCRTT2

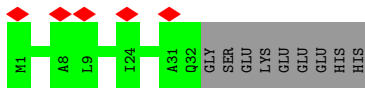
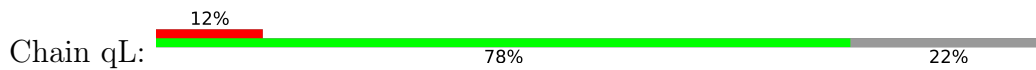

- Molecule 117: UQCRTT2

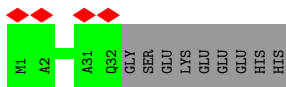
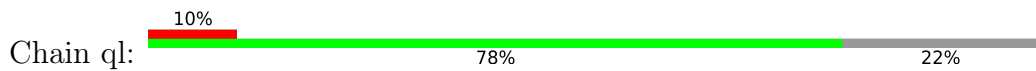

- Molecule 117: UQCRTT2

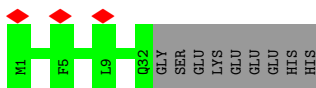
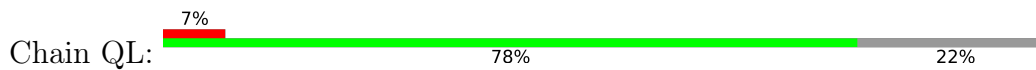

- Molecule 117: UQCRTT2

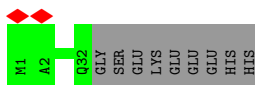
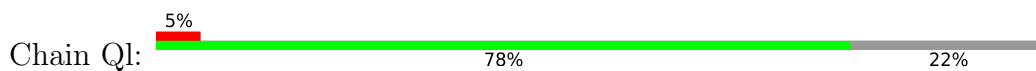

• Molecule 118: NADH-ubiquinone oxidoreductase 75 kDa subunit

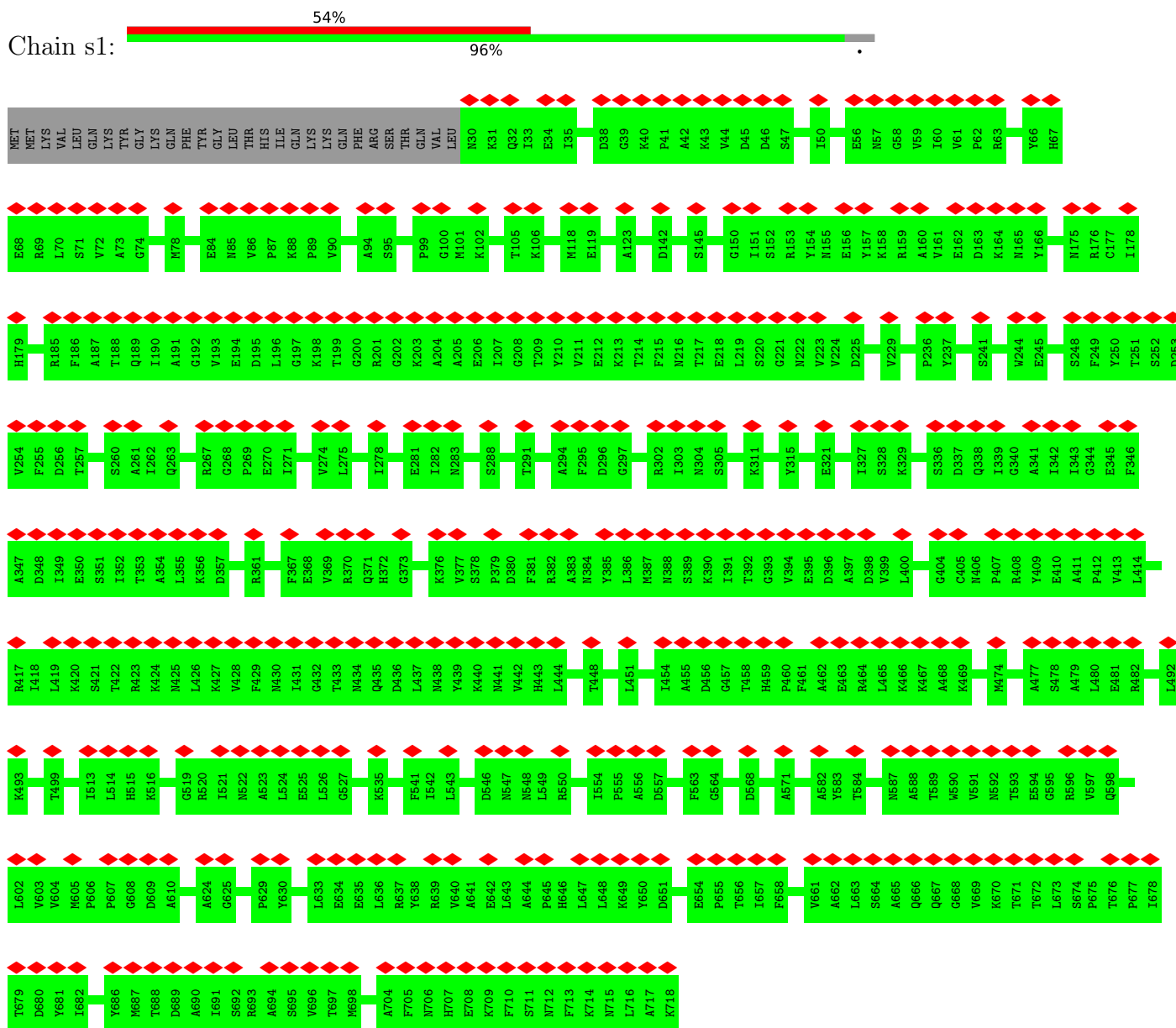

• Molecule 118: NADH-ubiquinone oxidoreductase 75 kDa subunit

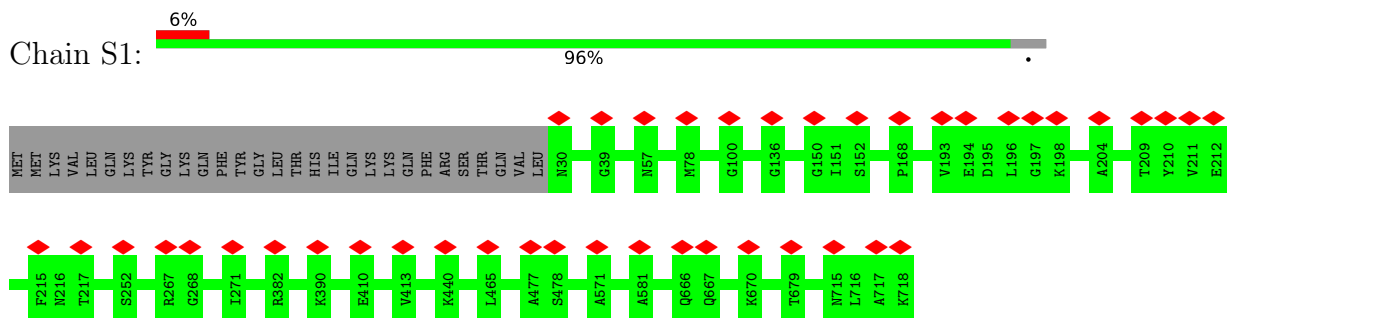

• Molecule 119: NADH dehydrogenase subunit 7

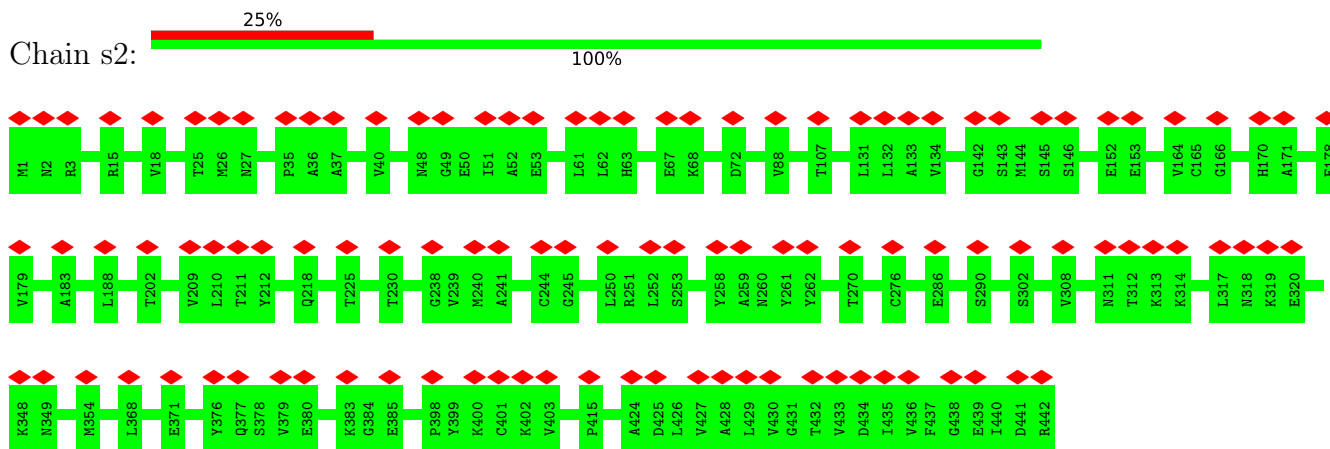

- Molecule 119: NADH dehydrogenase subunit 7

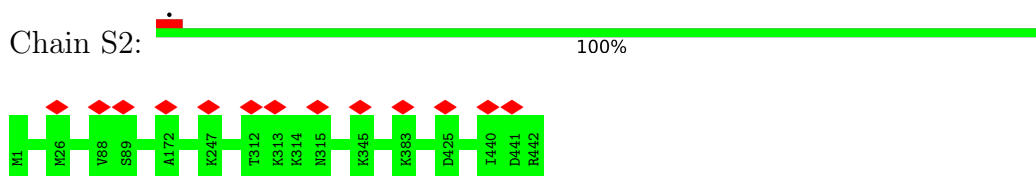

- Molecule 120: NADH dehydrogenase subunit 9

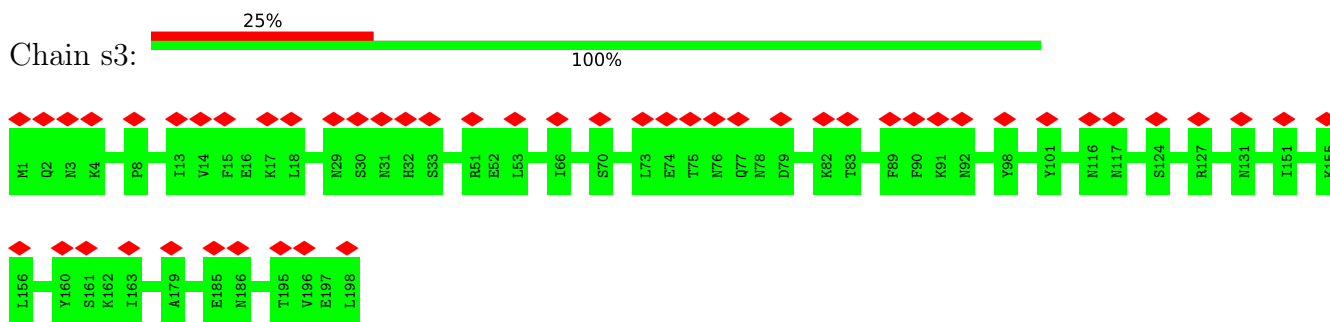

- Molecule 120: NADH dehydrogenase subunit 9

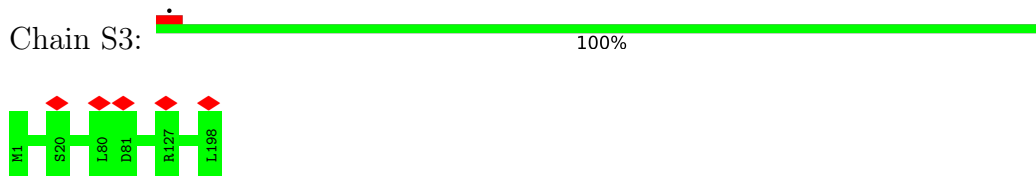

- Molecule 121: NADH dehydrogenase [ubiquinone] iron-sulfur protein 4, mitochondrial

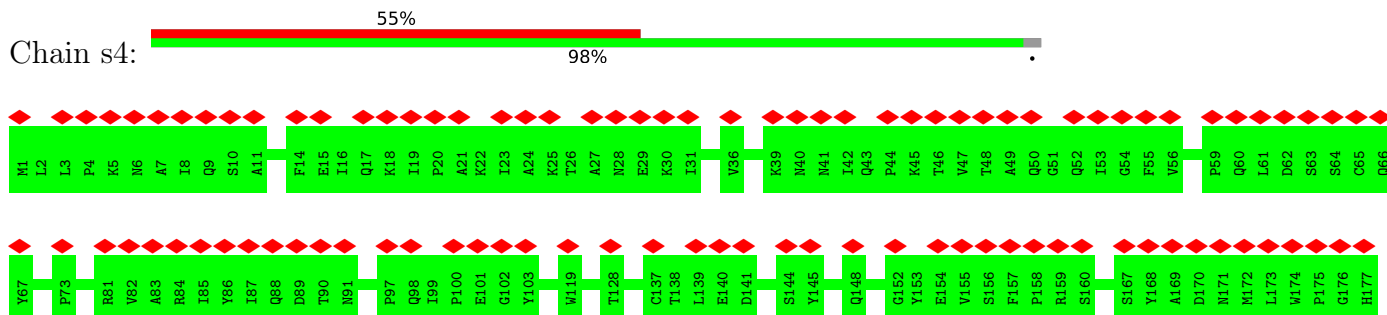



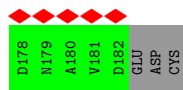

- Molecule 121: NADH dehydrogenase [ubiquinone] iron-sulfur protein 4, mitochondrial

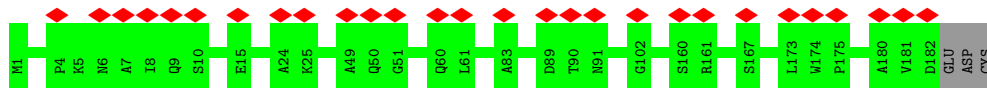

- Molecule 122: GRAM domain protein

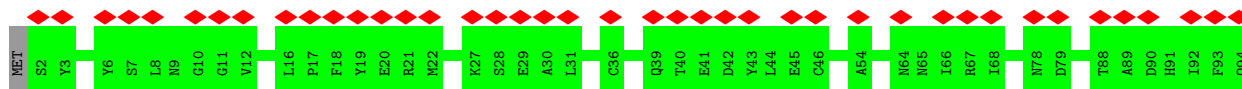
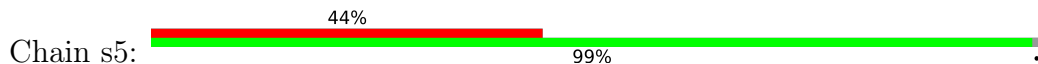

- Molecule 122: GRAM domain protein

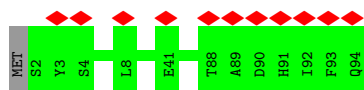

- Molecule 123: Zinc-finger protein

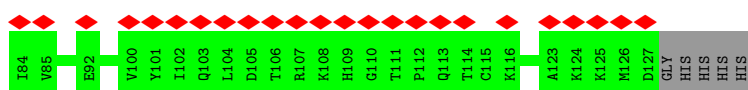
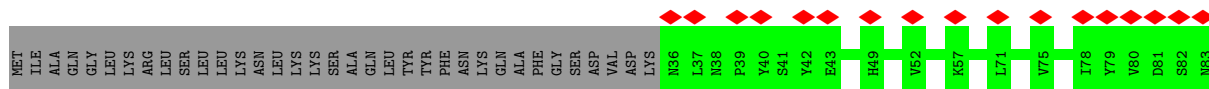

- Molecule 123: Zinc-finger protein

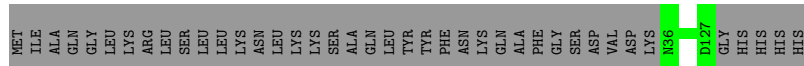

- Molecule 124: NADH dehydrogenase subunit 10



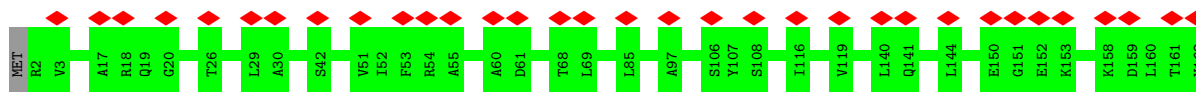

• Molecule 124: NADH dehydrogenase subunit 10

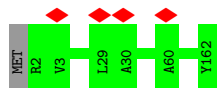

• Molecule 125: NADH-ubiquinone oxidoreductase 1, chain, putative

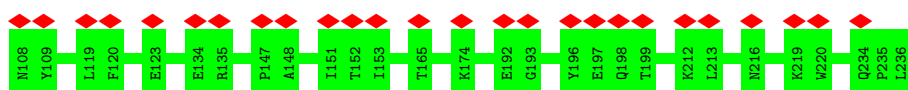
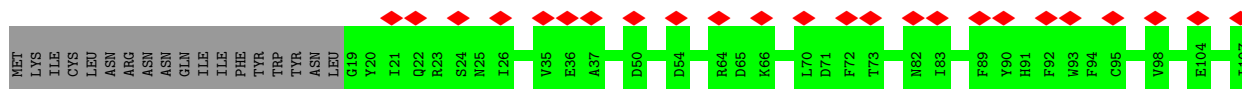
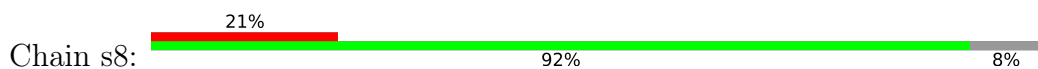

• Molecule 125: NADH-ubiquinone oxidoreductase 1, chain, putative



• Molecule 126: Succinate dehydrogenase [ubiquinone] flavoprotein subunit, mitochondrial

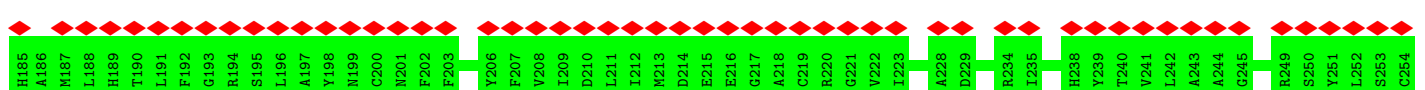
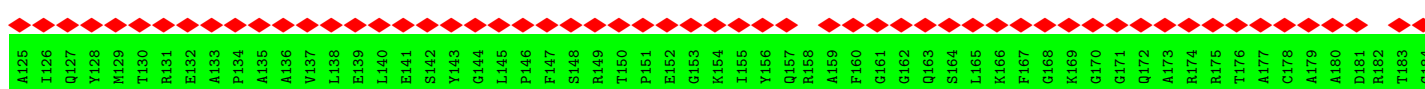
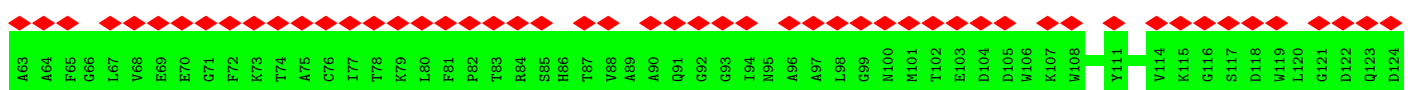
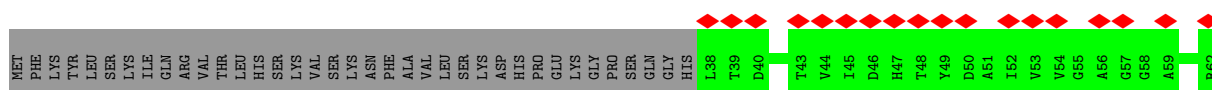
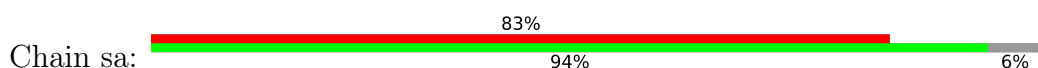

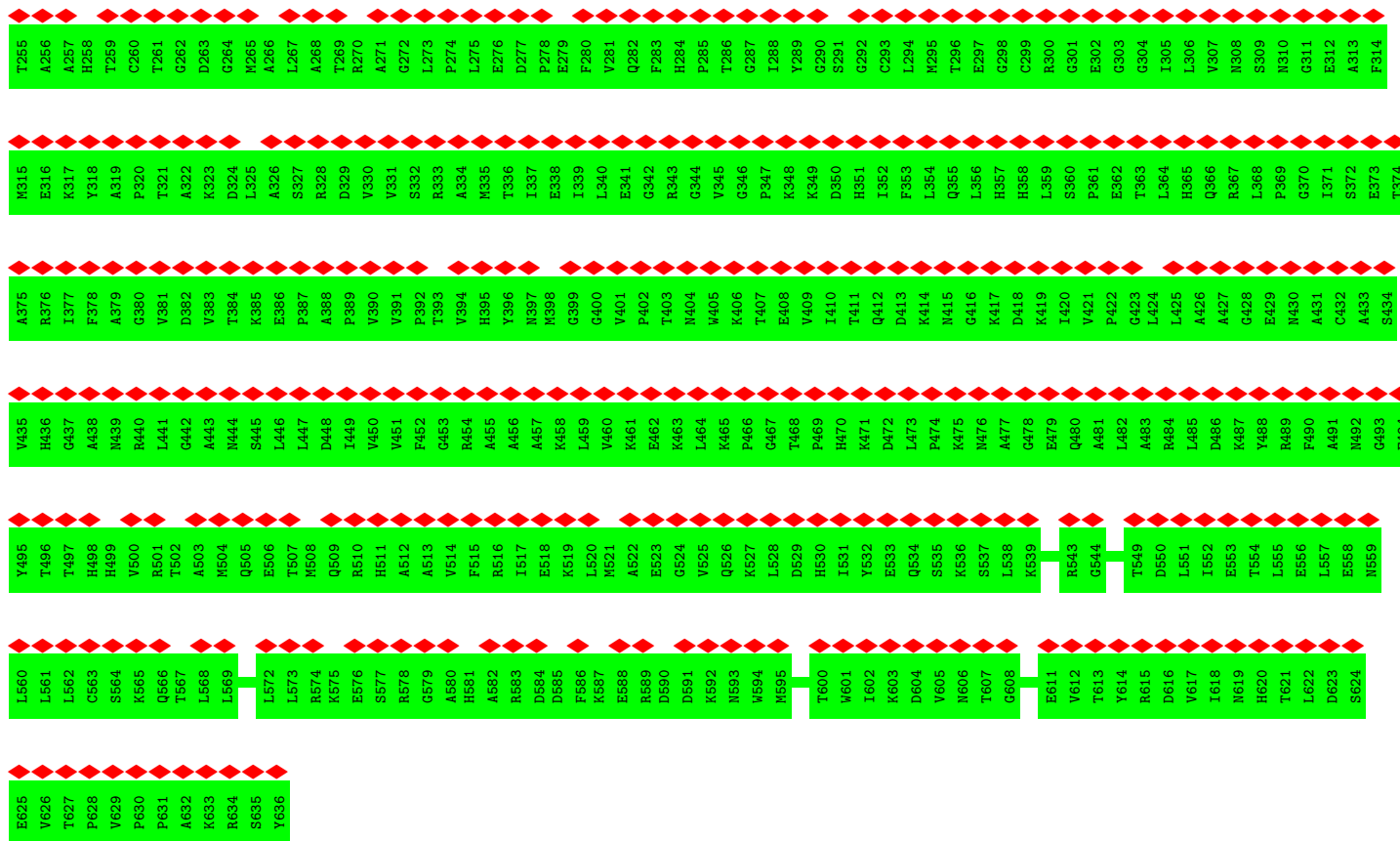

• Molecule 126: Succinate dehydrogenase [ubiquinone] flavoprotein subunit, mitochondrial

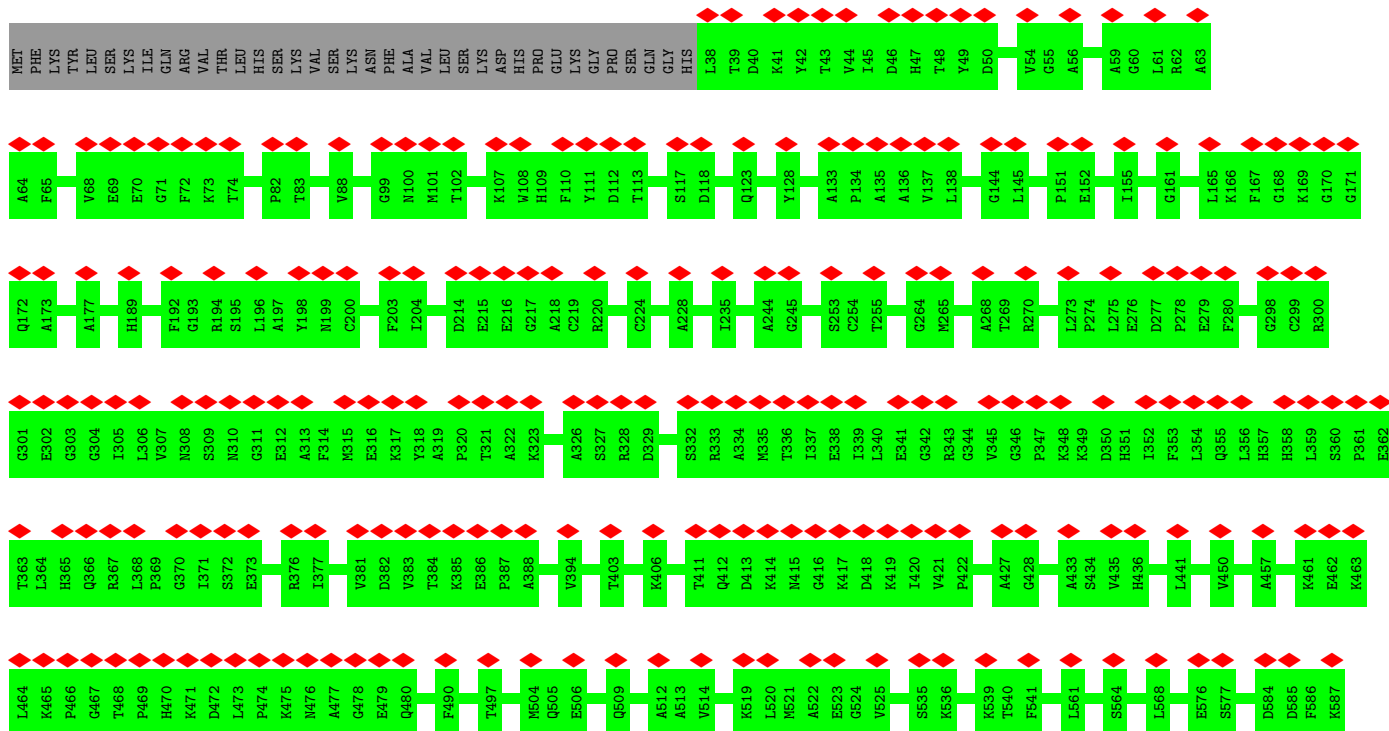
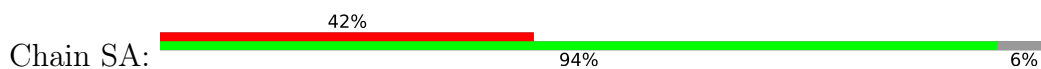

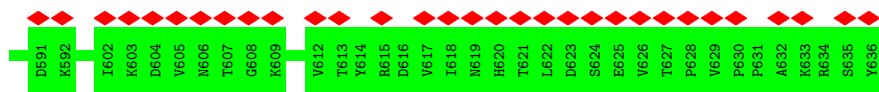

• Molecule 127: Succinate dehydrogenase (quinone)

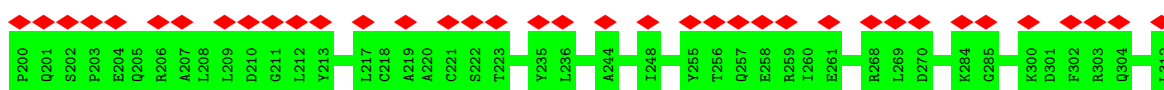
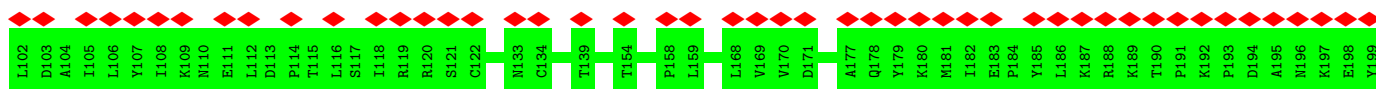
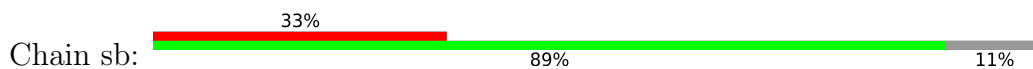

• Molecule 127: Succinate dehydrogenase (quinone)

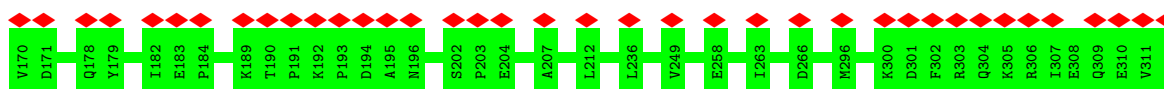
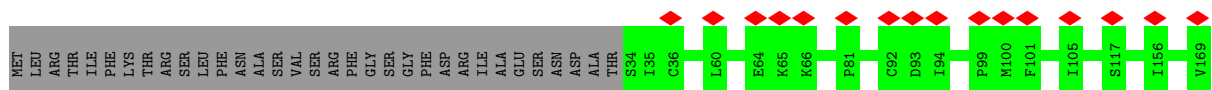
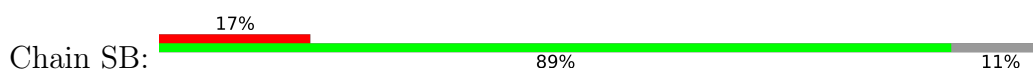

• Molecule 128: Cytochrome b-c1 complex subunit 8

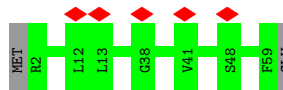

• Molecule 128: Cytochrome b-c1 complex subunit 8

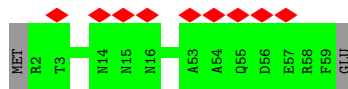

• Molecule 129: SDHD



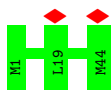

- Molecule 129: SDHD



- Molecule 130: Lipid-A-disaccharide synthase

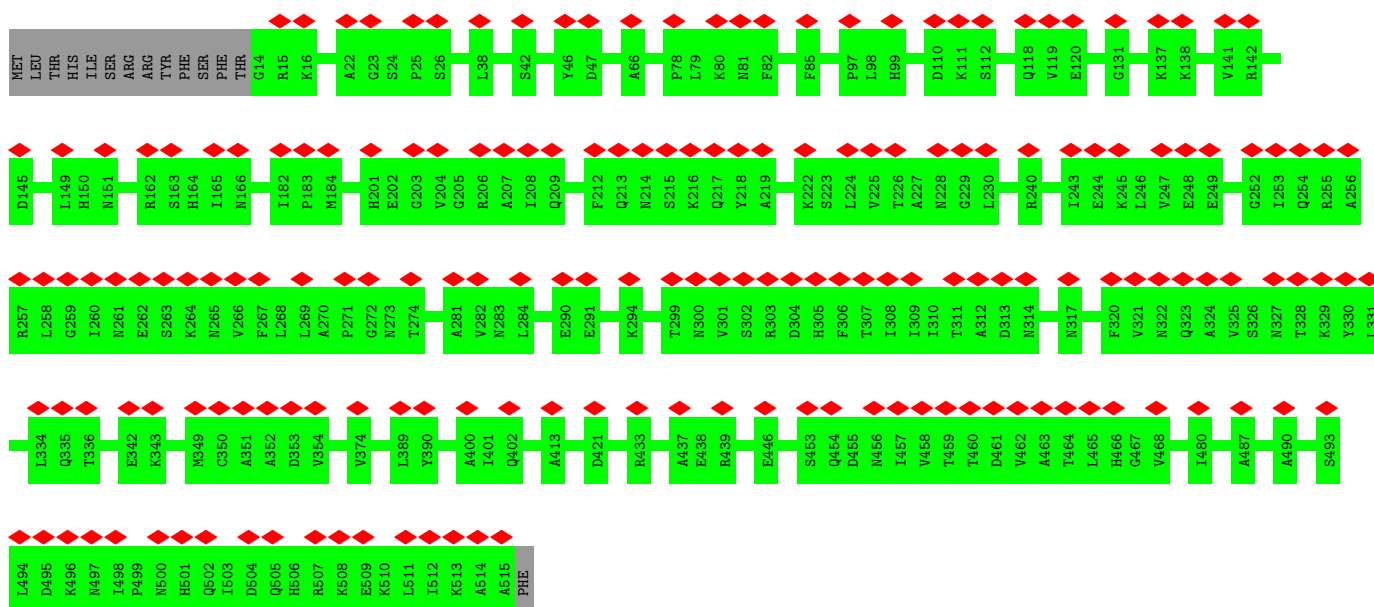

- Molecule 130: Lipid-A-disaccharide synthase

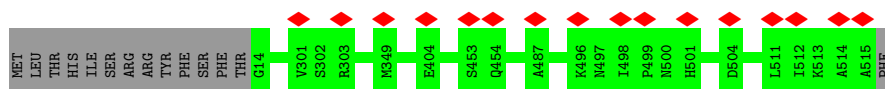

- Molecule 131: Acyl-CoA synthetase (AMP-forming)/AMP-acid ligase II

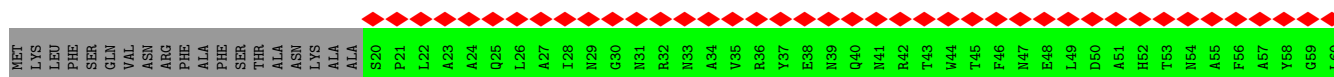
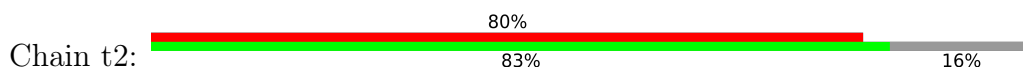



• Molecule 131: Acyl-CoA synthetase (AMP-forming)/AMP-acid ligase II

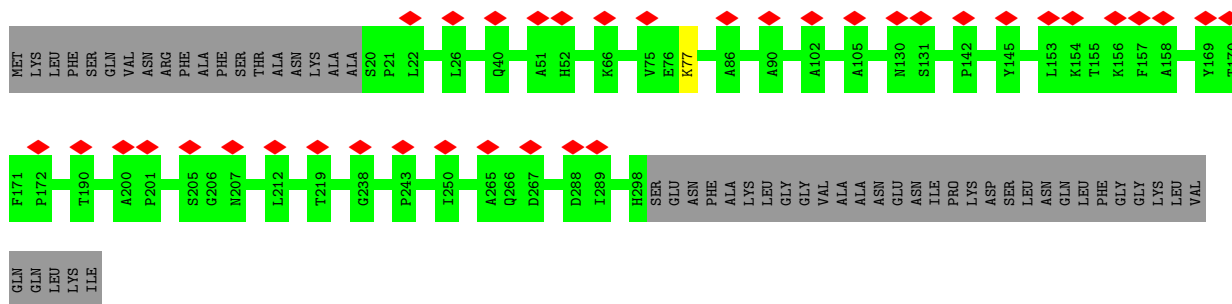
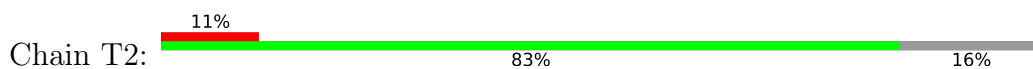

• Molecule 132: RNase III domain-containing protein

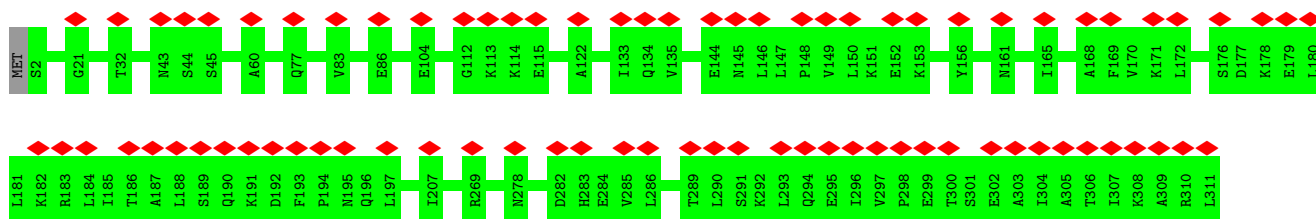

• Molecule 132: RNase III domain-containing protein

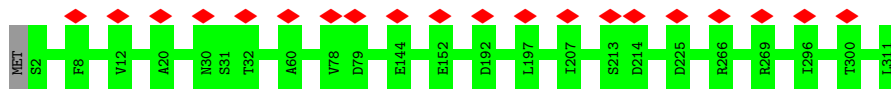

• Molecule 133: Transmembrane protein

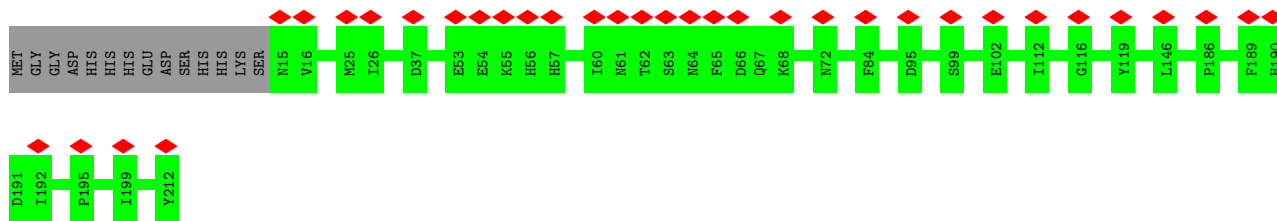
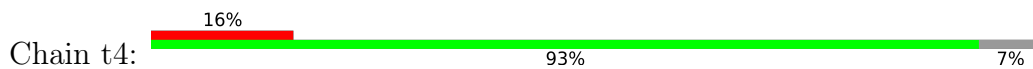

- Molecule 133: Transmembrane protein

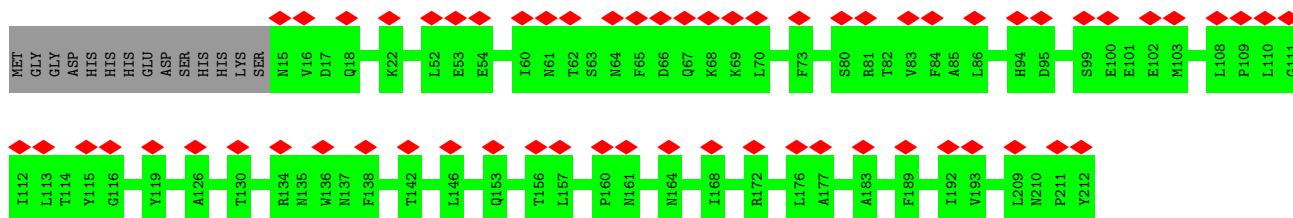

- Molecule 134: Transmembrane protein, putative

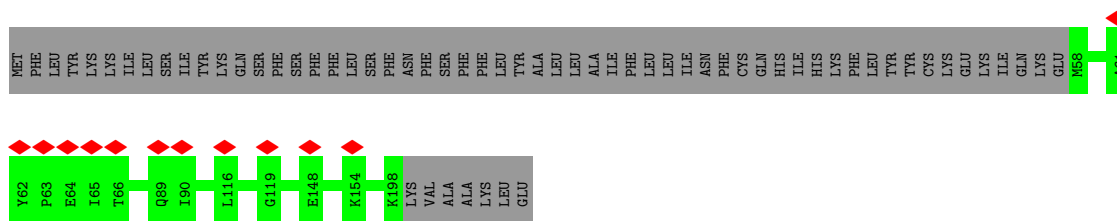

- Molecule 134: Transmembrane protein, putative

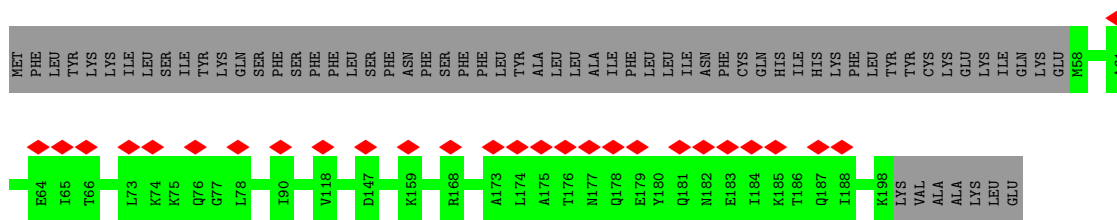

- Molecule 135: COX assembly mitochondrial protein

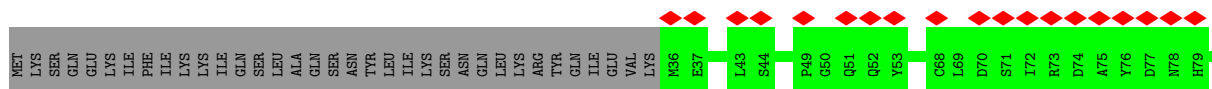
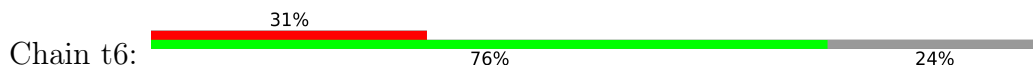

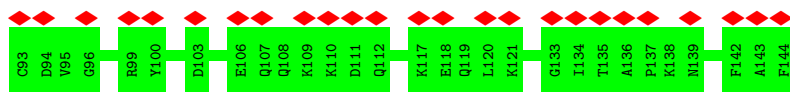

- Molecule 135: COX assembly mitochondrial protein

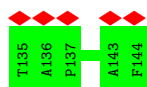
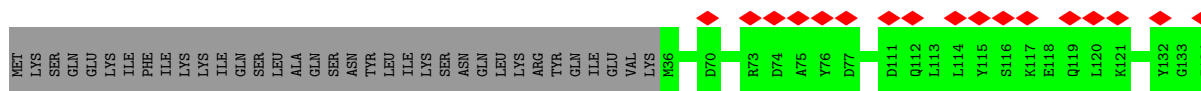
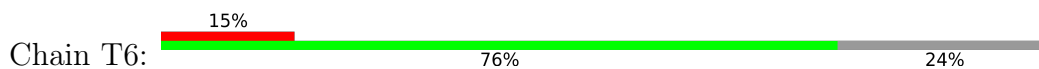

- Molecule 136: Transmembrane protein, putative

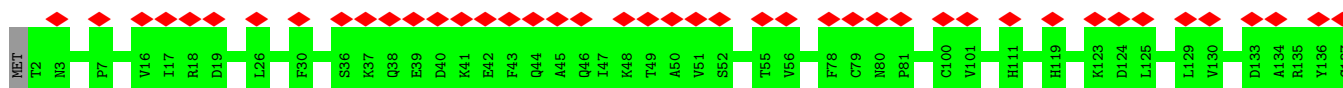

- Molecule 136: Transmembrane protein, putative

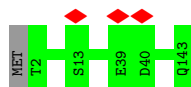

- Molecule 137: PH domain-containing protein

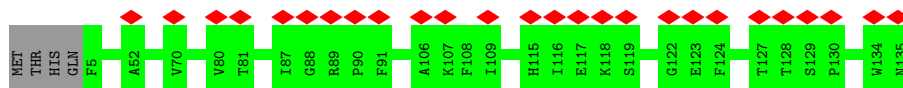

- Molecule 137: PH domain-containing protein

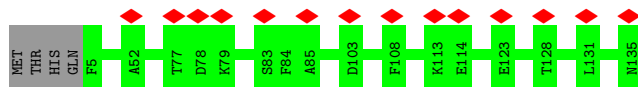

- Molecule 138: NADH dehydrogenase [ubiquinone] 1 alpha subcomplex subunit 8



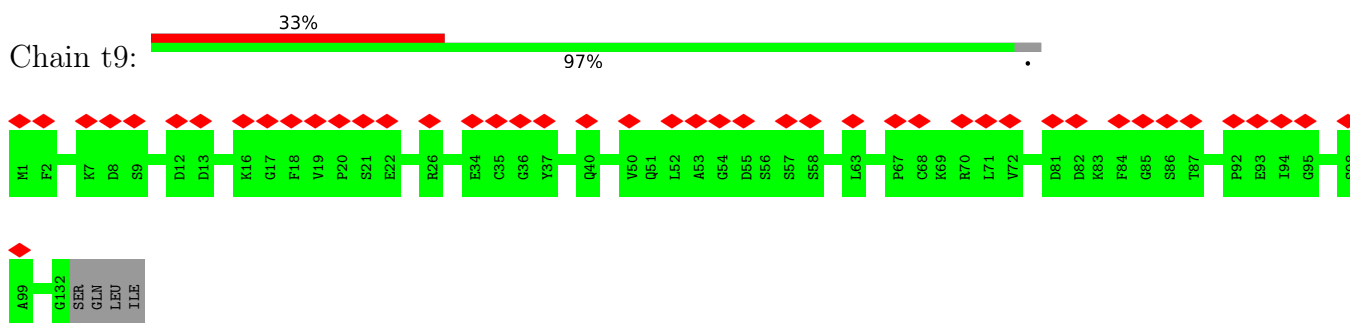

- Molecule 138: NADH dehydrogenase [ubiquinone] 1 alpha subcomplex subunit 8

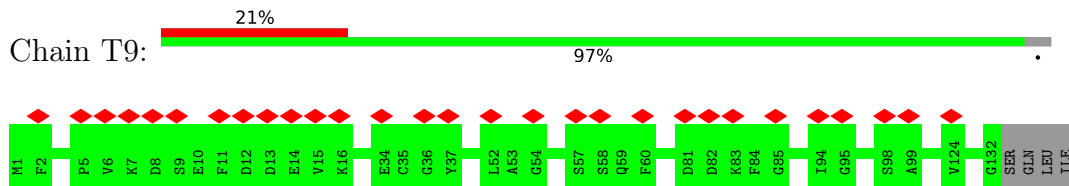

- Molecule 139: NADH dehydrogenase [ubiquinone] 1 beta subcomplex subunit 4

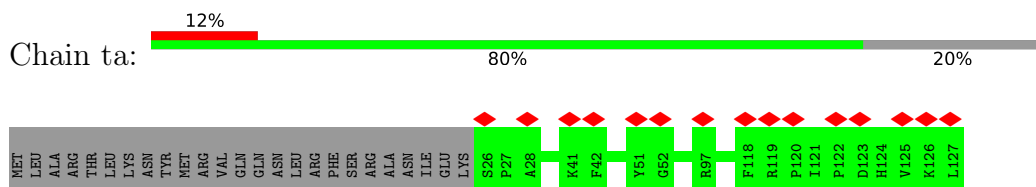

- Molecule 139: NADH dehydrogenase [ubiquinone] 1 beta subcomplex subunit 4

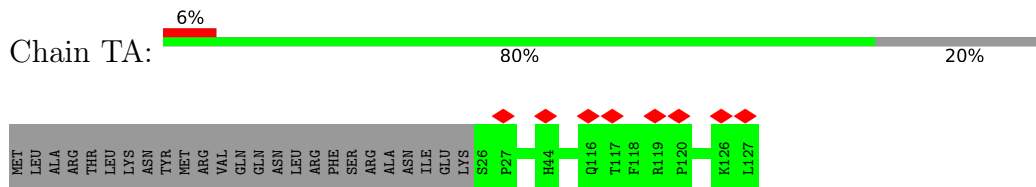

- Molecule 140: Transmembrane protein, putative

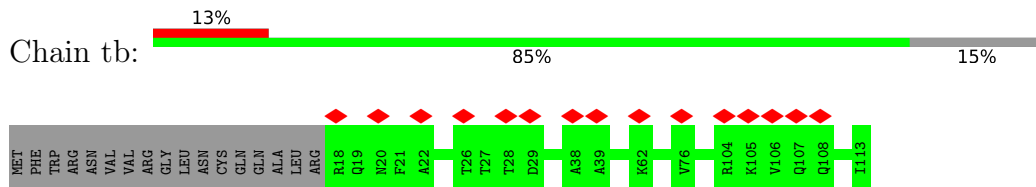

- Molecule 140: Transmembrane protein, putative

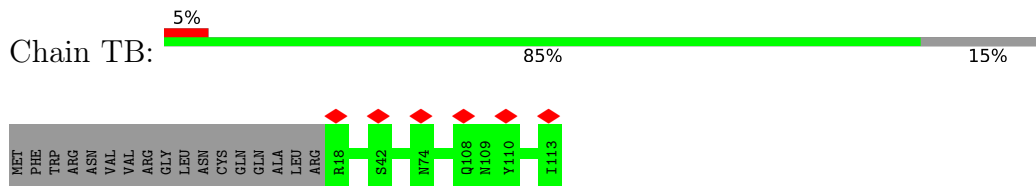

- Molecule 141: ATP synthase subunit e, mitochondrial



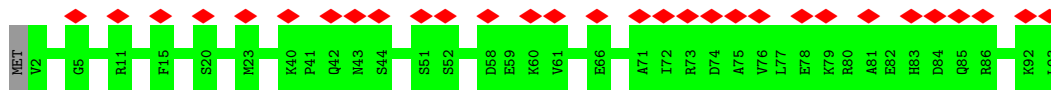

- Molecule 141: ATP synthase subunit e, mitochondrial

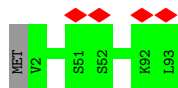

- Molecule 142: Transmembrane protein, putative

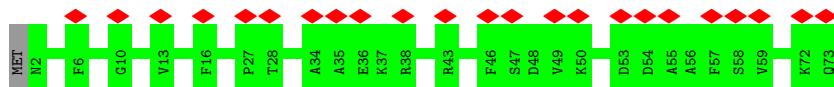

- Molecule 142: Transmembrane protein, putative

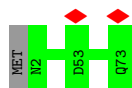

- Molecule 143: Transmembrane protein, putative

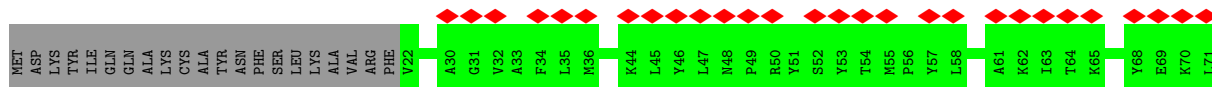
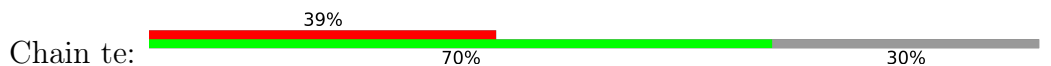

- Molecule 143: Transmembrane protein, putative

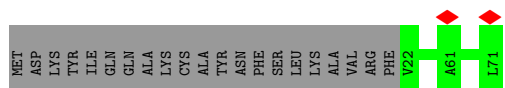

- Molecule 144: NDUTT15

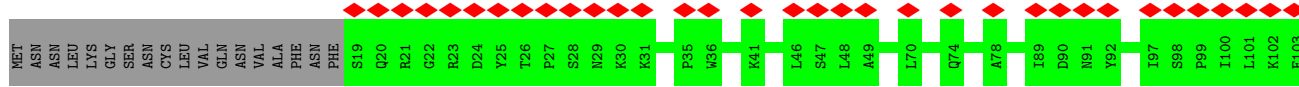
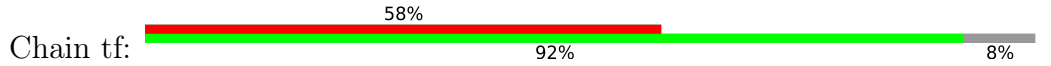

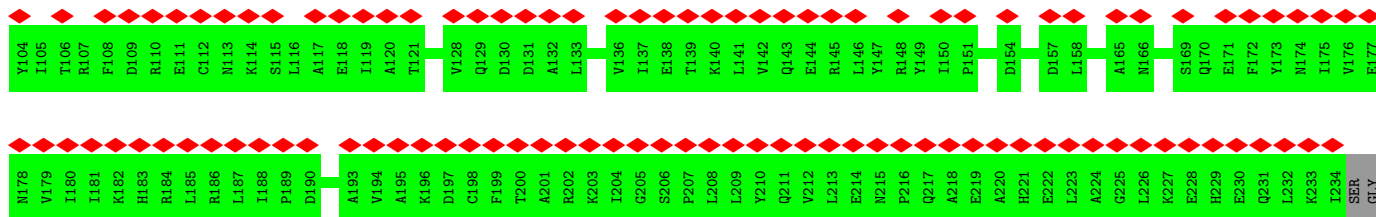

• Molecule 144: NDUTT15

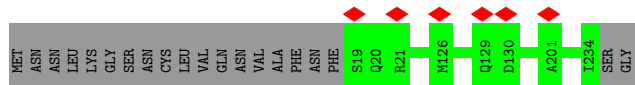

• Molecule 145: NDUTT16

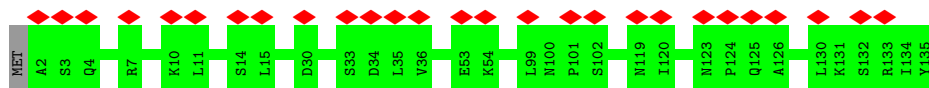

• Molecule 145: NDUTT16

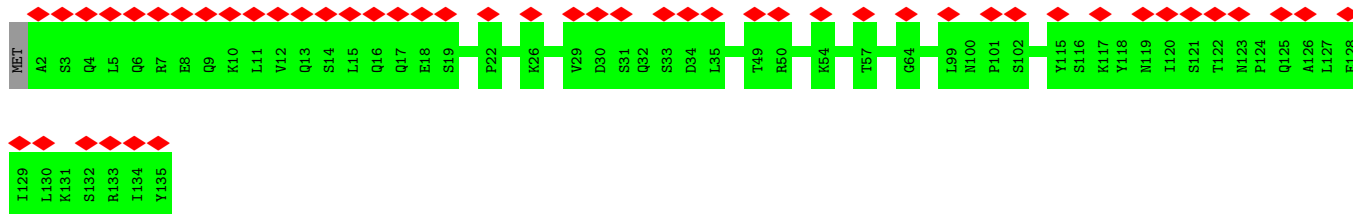
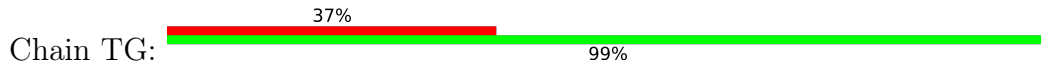

• Molecule 146: NDUTT17

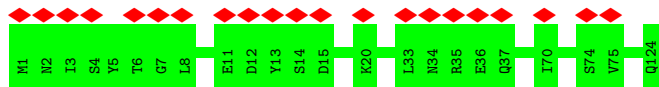

• Molecule 146: NDUTT17



• Molecule 147: Thioredoxin

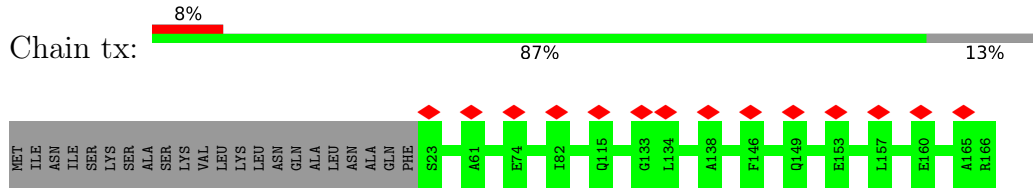

• Molecule 147: Thioredoxin

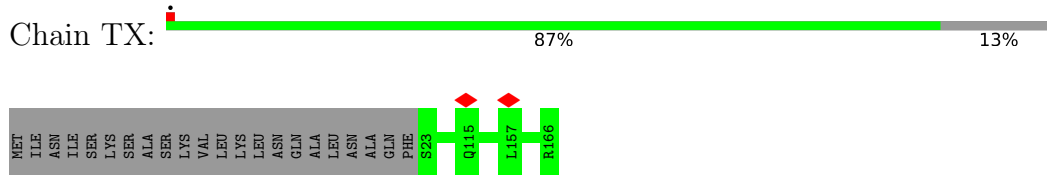

• Molecule 148: NADH dehydrogenase [ubiquinone] flavoprotein 1, mitochondrial



• Molecule 148: NADH dehydrogenase [ubiquinone] flavoprotein 1, mitochondrial



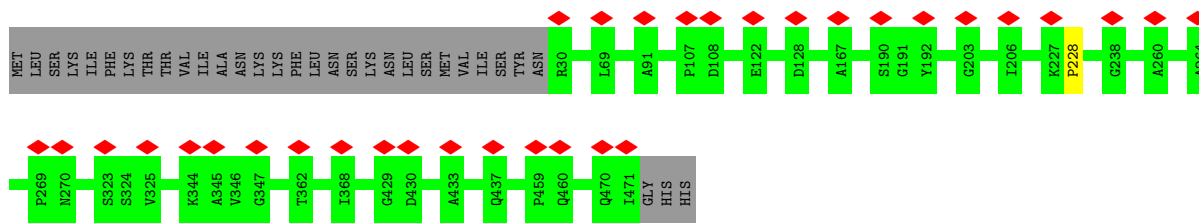

- Molecule 149: NADH-ubiquinone oxidoreductase 24 kDa subunit

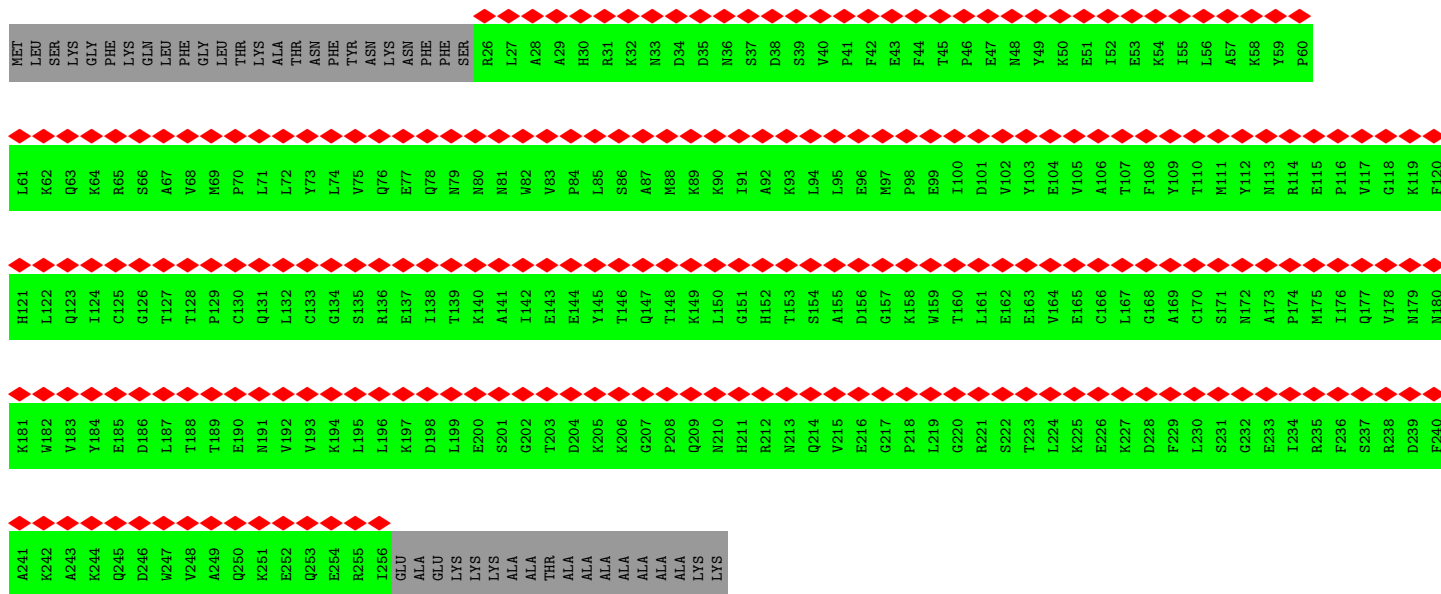
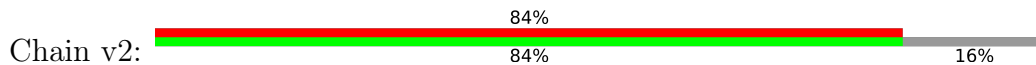

- Molecule 149: NADH-ubiquinone oxidoreductase 24 kDa subunit

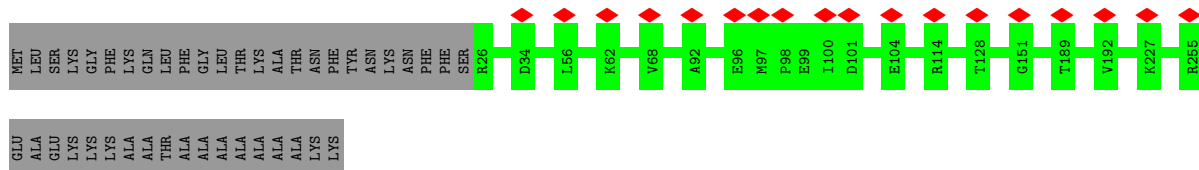
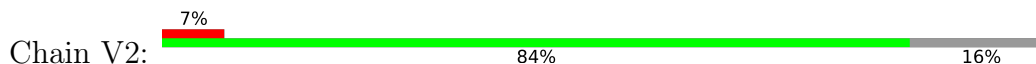

- Molecule 150: NADH-ubiquinone oxidoreductase complex I, 21 kDa subunit

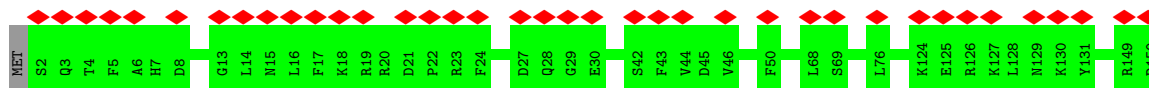

- Molecule 150: NADH-ubiquinone oxidoreductase complex I, 21 kDa subunit



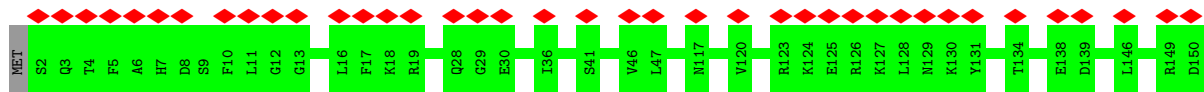

## 4 Experimental information

Property	Value	Source
EM reconstruction method	SINGLE PARTICLE	Depositor
Imposed symmetry	POINT, Not provided	
Number of particles used	19023	Depositor
Resolution determination method	FSC 0.143 CUT-OFF	Depositor
CTF correction method	PHASE FLIPPING AND AMPLITUDE CORRECTION	Depositor
Microscope	FEI TITAN KRIOS	Depositor
Voltage (kV)	300	Depositor
Electron dose ( $e^-/\text{\AA}^2$ )	51.4	Depositor
Minimum defocus (nm)	800	Depositor
Maximum defocus (nm)	2000	Depositor
Magnification	105000	Depositor
Image detector	FEI FALCON IV (4k x 4k)	Depositor
Maximum map value	25.410	Depositor
Minimum map value	-12.625	Depositor
Average map value	0.010	Depositor
Map value standard deviation	1.096	Depositor
Recommended contour level	4.0	Depositor
Map size (Å)	840.00006, 840.00006, 840.00006	wwPDB
Map dimensions	700, 700, 700	wwPDB
Map angles (°)	90.0, 90.0, 90.0	wwPDB
Pixel spacing (Å)	1.2, 1.2, 1.2	Depositor

## 5 Model quality i

### 5.1 Standard geometry i

Bond lengths and bond angles in the following residue types are not validated in this section: FES, HEA, FAD, SF4, U10, F3S, MG, HEC, CU, ADP, SEP, ZN, FMN, HEM, NDP, TPO

The Z score for a bond length (or angle) is the number of standard deviations the observed value is removed from the expected value. A bond length (or angle) with  $|Z| > 5$  is considered an outlier worth inspection. RMSZ is the root-mean-square of all Z scores of the bond lengths (or angles).

Mol	Chain	Bond lengths		Bond angles	
		RMSZ	# Z  >5	RMSZ	# Z  >5
1	00	0.24	0/2227	0.42	0/3106
1	55	0.24	0/2227	0.42	0/3106
1	A	0.24	0/2227	0.42	0/3106
1	a	0.24	0/2227	0.42	0/3106
2	01	0.24	0/2113	0.39	0/2939
2	56	0.24	0/2113	0.39	0/2939
2	B	0.24	0/2113	0.39	0/2939
2	b	0.24	0/2113	0.39	0/2939
3	02	0.25	0/1002	0.45	2/1394 (0.1%)
3	57	0.25	0/1002	0.46	2/1394 (0.1%)
3	C	0.25	0/1002	0.45	2/1394 (0.1%)
3	c	0.25	0/1002	0.46	2/1394 (0.1%)
4	03	0.24	0/1426	0.42	0/1984
4	58	0.24	0/1426	0.42	0/1984
4	D	0.24	0/1426	0.42	0/1984
4	d	0.24	0/1426	0.42	0/1984
5	04	0.24	0/1904	0.41	0/2655
5	59	0.24	0/1904	0.41	0/2655
5	E	0.24	0/1904	0.41	0/2655
5	e	0.24	0/1904	0.41	0/2655
6	05	0.24	0/1204	0.43	0/1678
6	60	0.24	0/1204	0.43	0/1678
6	F	0.24	0/1204	0.43	0/1678
6	f	0.24	0/1204	0.43	0/1678
7	06	0.24	0/1453	0.43	0/2026
7	61	0.24	0/1453	0.43	0/2026
7	G	0.24	0/1453	0.43	0/2026
7	g	0.24	0/1453	0.43	0/2026
8	07	0.24	0/1468	0.42	0/2041
8	62	0.24	0/1468	0.42	0/2041
8	H	0.24	0/1468	0.42	0/2041
8	h	0.24	0/1468	0.42	0/2041



Mol	Chain	Bond lengths		Bond angles	
		RMSZ	# Z  >5	RMSZ	# Z  >5
9	08	0.24	0/1140	0.41	0/1586
9	63	0.24	0/1140	0.40	0/1586
9	I	0.24	0/1140	0.41	0/1586
9	i	0.24	0/1140	0.40	0/1586
10	09	0.24	0/930	0.37	0/1298
10	64	0.24	0/930	0.37	0/1298
10	J	0.24	0/930	0.37	0/1298
10	j	0.24	0/930	0.37	0/1298
11	0A	0.23	0/345	0.36	0/479
11	45	0.23	0/345	0.35	0/479
11	6T	0.22	0/345	0.35	0/479
11	6t	0.23	0/345	0.36	0/479
12	0B	0.26	0/1857	0.49	0/2570
12	46	0.26	0/1857	0.48	0/2570
12	BP	0.26	0/1857	0.48	0/2570
12	bp	0.26	0/1857	0.49	0/2570
13	0C	0.26	0/927	0.43	0/1289
13	47	0.25	0/927	0.42	0/1289
13	FS	0.25	0/927	0.42	0/1289
13	fs	0.26	0/927	0.43	0/1289
14	0D	0.24	0/493	0.40	0/685
14	48	0.24	0/493	0.40	0/685
14	4A	0.24	0/493	0.40	0/685
14	4a	0.24	0/493	0.40	0/685
15	0E	0.22	0/1709	0.38	0/2387
15	49	0.22	0/1709	0.38	0/2387
15	Y7	0.22	0/1709	0.38	0/2387
15	y7	0.22	0/1709	0.38	0/2387
16	0F	0.22	0/946	0.36	0/1321
16	50	0.23	0/946	0.36	0/1321
16	Y5	0.23	0/946	0.36	0/1321
16	y5	0.22	0/946	0.36	0/1321
17	0G	0.23	0/443	0.41	0/618
17	51	0.23	0/443	0.40	0/618
17	Y0	0.23	0/443	0.40	0/618
17	y0	0.23	0/443	0.41	0/618
18	0H	0.24	0/478	0.35	0/664
18	52	0.25	0/478	0.35	0/664
18	Z1	0.25	0/478	0.35	0/664
18	z1	0.24	0/478	0.35	0/664
21	10	0.23	0/1031	0.39	0/1437
21	65	0.23	0/1031	0.40	0/1437
21	K	0.23	0/1031	0.39	0/1437

Mol	Chain	Bond lengths		Bond angles	
		RMSZ	# Z  >5	RMSZ	# Z  >5
21	k	0.23	0/1031	0.40	0/1437
22	11	0.24	0/964	0.36	0/1345
22	66	0.25	0/964	0.37	0/1345
22	L	0.24	0/964	0.36	0/1345
22	l	0.25	0/964	0.37	0/1345
23	12	0.24	0/1082	0.41	0/1506
23	67	0.24	0/1082	0.41	0/1506
23	M	0.24	0/1082	0.41	0/1506
23	m	0.24	0/1082	0.41	0/1506
24	13	0.24	0/1015	0.39	0/1411
24	68	0.24	0/1015	0.39	0/1411
24	N	0.24	0/1015	0.39	0/1411
24	n	0.24	0/1015	0.39	0/1411
25	14	0.23	0/640	0.35	0/892
25	69	0.23	0/640	0.35	0/892
25	O	0.24	0/640	0.35	0/892
25	o	0.23	0/640	0.35	0/892
26	15	0.24	0/864	0.40	0/1202
26	70	0.24	0/864	0.41	0/1202
26	P	0.24	0/864	0.40	0/1202
26	p	0.24	0/864	0.41	0/1202
27	16	0.23	0/854	0.40	0/1188
27	71	0.23	0/854	0.40	0/1188
27	Q	0.23	0/854	0.40	0/1188
27	q	0.23	0/854	0.40	0/1188
28	17	0.23	0/851	0.38	0/1185
28	72	0.23	0/851	0.38	0/1185
28	R	0.23	0/851	0.38	0/1185
28	r	0.23	0/851	0.38	0/1185
29	18	0.24	0/840	0.36	0/1172
29	73	0.23	0/840	0.35	0/1172
29	S	0.24	0/840	0.36	0/1172
29	s	0.23	0/840	0.35	0/1172
30	19	0.25	0/770	0.38	0/1071
30	74	0.24	0/770	0.39	0/1071
30	T	0.25	0/770	0.38	0/1071
30	t	0.24	0/770	0.39	0/1071
31	1B	0.22	0/292	0.34	0/406
31	1b	0.22	0/292	0.34	0/406
32	20	0.23	0/756	0.36	0/1052
32	75	0.23	0/756	0.36	0/1052
32	U	0.23	0/756	0.36	0/1052
32	u	0.23	0/756	0.36	0/1052

Mol	Chain	Bond lengths		Bond angles	
		RMSZ	# Z  >5	RMSZ	# Z  >5
33	21	0.25	0/721	0.42	0/1003
33	76	0.25	0/721	0.42	0/1003
33	V	0.25	0/721	0.42	0/1003
33	v	0.25	0/721	0.42	0/1003
34	22	0.23	0/611	0.38	0/852
34	77	0.23	0/611	0.37	0/852
34	W	0.23	0/611	0.38	0/852
34	w	0.23	0/611	0.37	0/852
35	23	0.23	0/601	0.36	0/835
35	78	0.23	0/601	0.35	0/835
35	X	0.23	0/601	0.36	0/835
35	x	0.23	0/601	0.35	0/835
36	24	0.24	0/516	0.37	0/716
36	79	0.24	0/516	0.36	0/716
36	Y	0.24	0/516	0.37	0/716
36	y	0.24	0/516	0.36	0/716
37	25	0.25	0/428	0.38	0/594
37	80	0.24	0/428	0.38	0/594
37	Z	0.25	0/428	0.38	0/594
37	z	0.24	0/428	0.38	0/594
38	26	0.24	0/3327	0.40	0/4631
38	81	0.24	0/3327	0.40	0/4631
38	C1	0.24	0/3327	0.40	0/4631
38	c1	0.24	0/3327	0.40	0/4631
39	27	0.23	0/2973	0.43	0/4147
39	82	0.23	0/2973	0.43	0/4147
39	C2	0.23	0/2973	0.43	0/4147
39	c2	0.23	0/2973	0.43	0/4147
40	28	0.23	0/2893	0.39	0/4039
40	83	0.23	0/2893	0.39	0/4039
40	C3	0.23	0/2893	0.39	0/4039
40	c3	0.23	0/2893	0.39	0/4039
41	29	0.24	0/2741	0.39	0/3820
41	84	0.24	0/2741	0.39	0/3820
41	VB	0.24	0/2741	0.39	0/3820
41	vb	0.24	0/2741	0.39	0/3820
42	2B	0.22	0/883	0.38	0/1231
42	2b	0.23	0/883	0.38	0/1231
43	2E	0.23	0/1590	0.41	0/2216
43	2e	0.24	0/1590	0.41	0/2216
44	2F	0.23	0/1076	0.38	0/1500
44	2f	0.24	0/1076	0.38	0/1500
45	2G	0.22	0/983	0.35	0/1371

Mol	Chain	Bond lengths		Bond angles	
		RMSZ	# Z  >5	RMSZ	# Z  >5
45	2g	0.23	0/983	0.35	0/1371
46	2H	0.22	0/505	0.34	0/702
46	2h	0.22	0/505	0.34	0/702
47	2I	0.24	0/563	0.36	0/783
47	2i	0.24	0/563	0.36	0/783
48	2J	0.23	0/504	0.34	0/701
48	2j	0.23	0/504	0.34	0/701
49	2K	0.24	0/461	0.43	0/642
49	2k	0.23	0/461	0.43	0/642
50	2L	0.23	0/414	0.36	0/578
50	2l	0.23	0/414	0.36	0/578
51	2M	0.23	0/369	0.44	0/512
51	2m	0.23	0/369	0.44	0/512
52	2N	0.25	0/301	0.46	0/418
52	2n	0.25	0/301	0.46	0/418
53	2O	0.23	0/209	0.39	0/291
53	2o	0.23	0/209	0.39	0/291
54	30	0.24	0/623	0.40	0/867
54	6A	0.24	0/623	0.40	0/867
54	6a	0.25	0/623	0.39	0/867
54	85	0.25	0/623	0.39	0/867
55	31	0.23	0/1100	0.39	0/1533
55	6B	0.23	0/1100	0.39	0/1533
55	6b	0.23	0/1100	0.39	0/1533
55	86	0.23	0/1100	0.39	0/1533
56	32	0.27	0/498	0.37	0/692
56	6C	0.27	0/498	0.37	0/692
56	6c	0.27	0/498	0.37	0/692
56	87	0.27	0/498	0.37	0/692
57	33	0.23	0/382	0.36	0/532
57	6L	0.23	0/382	0.36	0/532
57	6l	0.23	0/382	0.35	0/532
57	88	0.23	0/382	0.35	0/532
58	34	0.23	0/658	0.43	0/916
58	7A	0.23	0/658	0.43	0/916
58	7a	0.23	0/658	0.42	0/916
58	89	0.23	0/658	0.42	0/916
59	35	0.24	0/1040	0.43	0/1448
59	7C	0.24	0/1040	0.43	0/1448
59	7c	0.24	0/1040	0.43	0/1448
59	90	0.24	0/1040	0.43	0/1448
60	36	0.24	0/653	0.42	0/912
60	7L	0.24	0/653	0.42	0/912

Mol	Chain	Bond lengths		Bond angles	
		RMSZ	# Z  >5	RMSZ	# Z  >5
60	7l	0.24	0/653	0.42	0/912
60	9l	0.24	0/653	0.42	0/912
61	37	0.24	0/1708	0.41	0/2377
61	92	0.24	0/1708	0.41	0/2377
61	M1	0.24	0/1708	0.41	0/2377
61	m1	0.24	0/1708	0.41	0/2377
62	38	0.24	0/1560	0.38	0/2165
62	93	0.24	0/1560	0.38	0/2165
62	M2	0.24	0/1560	0.38	0/2165
62	m2	0.24	0/1560	0.38	0/2165
63	39	0.24	0/1623	0.40	0/2258
63	94	0.24	0/1623	0.40	0/2258
63	M3	0.24	0/1623	0.40	0/2258
63	m3	0.24	0/1623	0.40	0/2258
64	1T	0.22	0/348	0.32	0/485
64	1t	0.22	0/348	0.32	0/485
64	40	0.23	0/348	0.32	0/485
64	95	0.22	0/348	0.32	0/485
65	2T	0.22	0/347	0.33	0/483
65	2t	0.22	0/347	0.32	0/483
65	41	0.22	0/347	0.33	0/483
65	96	0.22	0/347	0.32	0/483
66	3T	0.23	0/412	0.37	0/574
66	3t	0.23	0/412	0.38	0/574
66	42	0.23	0/412	0.37	0/574
66	97	0.23	0/412	0.38	0/574
67	43	0.22	0/284	0.34	0/396
67	4T	0.22	0/284	0.34	0/396
67	4t	0.21	0/284	0.33	0/396
67	98	0.21	0/284	0.33	0/396
68	44	0.23	0/308	0.37	0/429
68	5T	0.23	0/308	0.37	0/429
68	5t	0.24	0/308	0.36	0/429
68	99	0.24	0/308	0.36	0/429
69	4L	0.22	0/575	0.36	0/801
69	4l	0.22	0/575	0.36	0/801
70	5B	0.22	0/497	0.35	0/693
70	5b	0.22	0/497	0.35	0/693
71	A1	0.24	0/462	0.40	0/644
71	a1	0.24	0/462	0.40	0/644
72	A2	0.23	0/486	0.40	0/677
72	a2	0.23	0/486	0.40	0/677
73	A3	0.23	0/632	0.41	0/876

Mol	Chain	Bond lengths		Bond angles	
		RMSZ	# Z  >5	RMSZ	# Z  >5
73	a3	0.23	0/632	0.41	0/876
74	A5	0.23	0/770	0.36	0/1074
74	a5	0.23	0/770	0.36	0/1074
75	A6	0.23	0/846	0.40	0/1175
75	a6	0.24	0/846	0.40	0/1175
76	A7	0.24	0/1403	0.40	0/1959
76	a7	0.24	0/1403	0.40	0/1959
77	A8	0.23	0/657	0.37	0/917
77	a8	0.23	0/657	0.37	0/917
78	A9	0.24	0/1677	0.41	0/2333
78	a9	0.24	0/1677	0.41	0/2333
79	AB	0.23	0/556	0.39	0/775
79	ab	0.23	0/556	0.39	0/775
80	AC	0.24	0/487	0.38	0/679
80	ac	0.24	0/487	0.38	0/679
81	AL	0.23	0/948	0.42	0/1316
81	al	0.24	0/948	0.42	0/1316
82	AM	0.24	0/793	0.39	0/1105
82	am	0.24	0/793	0.39	0/1105
83	AN	0.23	0/1134	0.39	0/1574
83	an	0.23	0/1134	0.39	0/1574
84	B2	0.23	0/589	0.38	0/817
84	b2	0.23	0/589	0.38	0/817
85	B3	0.23	0/341	0.40	0/474
85	b3	0.23	0/341	0.40	0/474
86	B4	0.24	0/567	0.40	0/788
86	b4	0.25	0/567	0.40	0/788
87	B6	0.24	0/347	0.40	0/483
87	b6	0.25	0/347	0.40	0/483
88	B7	0.23	0/571	0.38	0/793
88	b7	0.24	0/571	0.38	0/793
89	B8	0.23	0/861	0.41	0/1196
89	b8	0.23	0/861	0.41	0/1196
90	B9	0.24	0/934	0.39	0/1303
90	b9	0.24	0/934	0.39	0/1303
91	BL	0.23	0/868	0.38	0/1210
91	bl	0.23	0/868	0.38	0/1210
92	BM	0.23	0/809	0.39	0/1125
92	bm	0.23	0/809	0.39	0/1125
93	C4	0.24	0/506	0.36	0/705
93	c4	0.24	0/506	0.36	0/705
94	FX	0.24	0/721	0.43	0/1003
94	fx	0.25	0/721	0.43	0/1003

Mol	Chain	Bond lengths		Bond angles	
		RMSZ	# Z  >5	RMSZ	# Z  >5
95	G1	0.25	0/1125	0.45	0/1562
95	g1	0.25	0/1125	0.45	0/1562
96	G2	0.25	0/1128	0.44	0/1565
96	g2	0.25	0/1128	0.44	0/1565
97	G3	0.25	0/1710	0.42	0/2381
97	g3	0.25	0/1710	0.42	0/2381
98	J1	0.23	0/1303	0.38	0/1808
98	j1	0.23	0/1303	0.38	0/1808
99	N1	0.23	0/1396	0.37	0/1942
99	n1	0.23	0/1396	0.37	0/1942
100	N2	0.22	0/1792	0.37	0/2503
100	n2	0.22	0/1792	0.37	0/2503
101	N3	0.23	0/595	0.37	0/829
101	n3	0.23	0/595	0.37	0/829
102	N4	0.23	0/2501	0.37	0/3486
102	n4	0.23	0/2501	0.37	0/3486
103	N5	0.23	0/3516	0.38	0/4904
103	n5	0.23	0/3516	0.38	0/4904
104	N6	0.23	0/1268	0.39	0/1770
104	n6	0.23	0/1268	0.39	0/1770
105	P1	0.24	0/1138	0.42	0/1585
105	p1	0.24	0/1138	0.42	0/1585
106	P2	0.23	0/830	0.44	0/1158
106	p2	0.24	0/830	0.44	0/1158
107	QA	0.24	0/2244	0.41	0/3124
107	Qa	0.24	0/2244	0.42	0/3124
107	qA	0.24	0/2244	0.41	0/3124
107	qa	0.24	0/2244	0.42	0/3124
108	QB	0.24	0/2369	0.43	0/3297
108	Qb	0.24	0/2369	0.43	0/3297
108	qB	0.24	0/2369	0.43	0/3297
108	qb	0.24	0/2369	0.43	0/3297
109	QC	0.23	0/2108	0.39	0/2937
109	Qc	0.24	0/2103	0.38	0/2930
109	qC	0.23	0/2108	0.39	0/2937
109	qc	0.24	0/2103	0.38	0/2930
110	QD	0.25	0/1447	0.43	0/2008
110	Qd	0.25	0/1447	0.43	0/2008
110	qD	0.25	0/1447	0.43	0/2008
110	qd	0.25	0/1447	0.43	0/2008
111	QE	0.24	0/1129	0.44	0/1566
111	Qe	0.24	0/1075	0.44	0/1491
111	qE	0.24	0/1129	0.44	0/1566

Mol	Chain	Bond lengths		Bond angles	
		RMSZ	# Z  >5	RMSZ	# Z  >5
111	qe	0.24	0/1075	0.44	0/1491
112	QF	0.24	0/440	0.39	0/612
112	Qf	0.24	0/396	0.37	0/551
112	qF	0.24	0/440	0.39	0/612
112	qf	0.24	0/396	0.37	0/551
113	QG	0.24	0/1620	0.40	0/2258
113	Qg	0.23	0/1615	0.39	0/2251
113	qG	0.24	0/1620	0.40	0/2258
113	qg	0.23	0/1615	0.39	0/2251
114	QH	0.23	0/634	0.41	0/880
114	Qh	0.23	0/634	0.41	0/880
114	qH	0.23	0/634	0.41	0/880
114	qh	0.23	0/634	0.41	0/880
115	QI	0.24	0/566	0.38	0/789
115	Qi	0.24	0/566	0.39	0/789
115	qI	0.24	0/566	0.38	0/789
115	qi	0.24	0/566	0.39	0/789
116	QJ	0.24	0/276	0.35	0/383
116	Qj	0.24	0/286	0.37	0/397
116	qJ	0.25	0/276	0.35	0/383
116	qj	0.25	0/286	0.37	0/397
117	QL	0.24	0/159	0.32	0/221
117	Ql	0.23	0/159	0.33	0/221
117	qL	0.24	0/159	0.32	0/221
117	ql	0.23	0/159	0.34	0/221
118	S1	0.24	0/3399	0.43	0/4730
118	s1	0.24	0/3399	0.43	0/4730
119	S2	0.24	0/2184	0.41	0/3041
119	s2	0.24	0/2184	0.41	0/3041
120	S3	0.23	0/987	0.44	0/1379
120	s3	0.23	0/987	0.44	0/1379
121	S4	0.24	0/899	0.43	0/1251
121	s4	0.24	0/899	0.43	0/1251
122	S5	0.24	0/461	0.38	0/642
122	s5	0.24	0/461	0.38	0/642
123	S6	0.24	0/454	0.44	0/631
123	s6	0.24	0/454	0.44	0/631
124	S7	0.24	0/791	0.42	0/1098
124	s7	0.24	0/791	0.42	0/1098
125	S8	0.24	0/1079	0.42	0/1503
125	s8	0.24	0/1079	0.42	0/1503
126	SA	0.24	0/2936	0.44	0/4074
126	sa	0.24	0/2936	0.44	0/4074



Mol	Chain	Bond lengths		Bond angles	
		RMSZ	# Z  >5	RMSZ	# Z  >5
127	SB	0.24	0/1383	0.40	0/1928
127	sb	0.24	0/1383	0.41	0/1928
128	SC	0.24	0/285	0.39	0/395
128	sc	0.24	0/285	0.39	0/395
129	SD	0.21	0/219	0.31	0/305
129	sd	0.21	0/219	0.31	0/305
130	T1	0.24	0/2489	0.40	0/3471
130	t1	0.24	0/2489	0.40	0/3471
131	T2	0.24	0/1375	0.43	0/1912
131	t2	0.24	0/1375	0.43	0/1912
132	T3	0.23	0/1540	0.37	0/2149
132	t3	0.23	0/1540	0.37	0/2149
133	T4	0.23	0/980	0.36	0/1365
133	t4	0.23	0/980	0.36	0/1365
134	T5	0.24	0/697	0.38	0/970
134	t5	0.24	0/697	0.38	0/970
135	T6	0.23	0/541	0.37	0/754
135	t6	0.23	0/541	0.37	0/754
136	T7	0.23	0/701	0.38	0/975
136	t7	0.24	0/701	0.38	0/975
137	T8	0.23	0/650	0.37	0/906
137	t8	0.23	0/650	0.37	0/906
138	T9	0.23	0/650	0.39	0/903
138	t9	0.23	0/650	0.39	0/903
139	TA	0.24	0/503	0.38	0/699
139	ta	0.25	0/503	0.38	0/699
140	TB	0.24	0/474	0.40	0/659
140	tb	0.24	0/474	0.40	0/659
141	TC	0.23	0/457	0.33	0/637
141	tc	0.23	0/457	0.33	0/637
142	TD	0.23	0/358	0.37	0/499
142	td	0.23	0/358	0.37	0/499
143	TE	0.24	0/247	0.40	0/343
143	te	0.24	0/247	0.40	0/343
144	TF	0.23	0/1073	0.36	0/1497
144	tf	0.23	0/1073	0.36	0/1497
145	TG	0.23	0/664	0.36	0/925
145	tg	0.23	0/664	0.36	0/925
146	TH	0.24	0/610	0.38	0/847
146	th	0.24	0/610	0.38	0/847
147	TX	0.24	0/714	0.39	0/995
147	tx	0.24	0/714	0.39	0/995
148	V1	0.25	0/2162	0.43	0/2997

Mol	Chain	Bond lengths		Bond angles	
		RMSZ	# Z  >5	RMSZ	# Z  >5
148	v1	0.25	0/2162	0.43	0/2997
149	V2	0.24	0/1143	0.40	0/1592
149	v2	0.24	0/1143	0.40	0/1592
150	X1	0.23	0/731	0.40	0/1014
150	x1	0.23	0/731	0.40	0/1014
All	All	0.24	0/442770	0.40	8/616418 (0.0%)

Chiral center outliers are detected by calculating the chiral volume of a chiral center and verifying if the center is modelled as a planar moiety or with the opposite hand. A planarity outlier is detected by checking planarity of atoms in a peptide group, atoms in a mainchain group or atoms of a sidechain that are expected to be planar.

Mol	Chain	#Chirality outliers	#Planarity outliers
148	V1	0	1
148	v1	0	1
All	All	0	2

There are no bond length outliers.

The worst 5 of 8 bond angle outliers are listed below:

Mol	Chain	Res	Type	Atoms	Z	Observed(°)	Ideal(°)
3	57	87	PRO	N-CA-CB	6.92	111.61	103.30
3	c	87	PRO	N-CA-CB	6.91	111.59	103.30
3	02	87	PRO	N-CA-CB	6.80	111.46	103.30
3	C	87	PRO	N-CA-CB	6.79	111.45	103.30
3	C	69	PRO	N-CA-CB	5.70	110.14	103.30

There are no chirality outliers.

All (2) planarity outliers are listed below:

Mol	Chain	Res	Type	Group
148	V1	228	PRO	Peptide
148	v1	228	PRO	Peptide

## 5.2 Too-close contacts [i](#)

Due to software issues we are unable to calculate clashes - this section is therefore empty.

## 5.3 Torsion angles

### 5.3.1 Protein backbone

In the following table, the Percentiles column shows the percent Ramachandran outliers of the chain as a percentile score with respect to all PDB entries followed by that with respect to all EM entries.

The Analysed column shows the number of residues for which the backbone conformation was analysed, and the total number of residues.

Mol	Chain	Analysed	Favoured	Allowed	Outliers	Percentiles	
1	00	447/490 (91%)	434 (97%)	13 (3%)	0	100	100
1	55	447/490 (91%)	433 (97%)	14 (3%)	0	100	100
1	A	447/490 (91%)	434 (97%)	13 (3%)	0	100	100
1	a	447/490 (91%)	433 (97%)	14 (3%)	0	100	100
2	01	422/473 (89%)	403 (96%)	18 (4%)	1 (0%)	47	80
2	56	422/473 (89%)	407 (96%)	15 (4%)	0	100	100
2	B	422/473 (89%)	402 (95%)	19 (4%)	1 (0%)	47	80
2	b	422/473 (89%)	407 (96%)	15 (4%)	0	100	100
3	02	201/212 (95%)	190 (94%)	10 (5%)	1 (0%)	29	68
3	57	201/212 (95%)	195 (97%)	5 (2%)	1 (0%)	29	68
3	C	201/212 (95%)	190 (94%)	10 (5%)	1 (0%)	29	68
3	c	201/212 (95%)	195 (97%)	5 (2%)	1 (0%)	29	68
4	03	287/402 (71%)	282 (98%)	5 (2%)	0	100	100
4	58	287/402 (71%)	275 (96%)	12 (4%)	0	100	100
4	D	287/402 (71%)	282 (98%)	5 (2%)	0	100	100
4	d	287/402 (71%)	275 (96%)	12 (4%)	0	100	100
5	04	382/385 (99%)	366 (96%)	16 (4%)	0	100	100
5	59	382/385 (99%)	365 (96%)	17 (4%)	0	100	100
5	E	382/385 (99%)	366 (96%)	16 (4%)	0	100	100
5	e	382/385 (99%)	365 (96%)	17 (4%)	0	100	100
6	05	241/348 (69%)	237 (98%)	4 (2%)	0	100	100
6	60	241/348 (69%)	237 (98%)	4 (2%)	0	100	100
6	F	241/348 (69%)	237 (98%)	4 (2%)	0	100	100
6	f	241/348 (69%)	237 (98%)	4 (2%)	0	100	100
7	06	291/318 (92%)	279 (96%)	12 (4%)	0	100	100

*Continued on next page...*

*Continued from previous page...*

Mol	Chain	Analysed	Favoured	Allowed	Outliers	Percentiles	
7	61	291/318 (92%)	283 (97%)	8 (3%)	0	100	100
7	G	291/318 (92%)	279 (96%)	12 (4%)	0	100	100
7	g	291/318 (92%)	283 (97%)	8 (3%)	0	100	100
8	07	296/318 (93%)	286 (97%)	10 (3%)	0	100	100
8	62	296/318 (93%)	290 (98%)	6 (2%)	0	100	100
8	H	296/318 (93%)	287 (97%)	9 (3%)	0	100	100
8	h	296/318 (93%)	290 (98%)	6 (2%)	0	100	100
9	08	229/252 (91%)	219 (96%)	10 (4%)	0	100	100
9	63	229/252 (91%)	220 (96%)	8 (4%)	1 (0%)	34	71
9	I	229/252 (91%)	218 (95%)	11 (5%)	0	100	100
9	i	229/252 (91%)	219 (96%)	9 (4%)	1 (0%)	34	71
10	09	185/234 (79%)	180 (97%)	5 (3%)	0	100	100
10	64	185/234 (79%)	179 (97%)	6 (3%)	0	100	100
10	J	185/234 (79%)	180 (97%)	5 (3%)	0	100	100
10	j	185/234 (79%)	179 (97%)	6 (3%)	0	100	100
11	0A	68/72 (94%)	68 (100%)	0	0	100	100
11	45	68/72 (94%)	68 (100%)	0	0	100	100
11	6T	68/72 (94%)	68 (100%)	0	0	100	100
11	6t	68/72 (94%)	68 (100%)	0	0	100	100
12	0B	379/462 (82%)	356 (94%)	23 (6%)	0	100	100
12	46	379/462 (82%)	359 (95%)	20 (5%)	0	100	100
12	BP	379/462 (82%)	359 (95%)	20 (5%)	0	100	100
12	bp	379/462 (82%)	356 (94%)	23 (6%)	0	100	100
13	0C	186/188 (99%)	179 (96%)	7 (4%)	0	100	100
13	47	186/188 (99%)	179 (96%)	7 (4%)	0	100	100
13	FS	186/188 (99%)	179 (96%)	7 (4%)	0	100	100
13	fs	186/188 (99%)	179 (96%)	7 (4%)	0	100	100
14	0D	98/127 (77%)	96 (98%)	2 (2%)	0	100	100
14	48	98/127 (77%)	96 (98%)	2 (2%)	0	100	100
14	4A	98/127 (77%)	96 (98%)	2 (2%)	0	100	100
14	4a	98/127 (77%)	96 (98%)	2 (2%)	0	100	100

*Continued on next page...*

*Continued from previous page...*

Mol	Chain	Analysed	Favoured	Allowed	Outliers	Percentiles	
15	0E	339/453 (75%)	330 (97%)	9 (3%)	0	100	100
15	49	339/453 (75%)	330 (97%)	9 (3%)	0	100	100
15	Y7	339/453 (75%)	330 (97%)	9 (3%)	0	100	100
15	y7	339/453 (75%)	330 (97%)	9 (3%)	0	100	100
16	0F	188/190 (99%)	184 (98%)	4 (2%)	0	100	100
16	50	188/190 (99%)	182 (97%)	6 (3%)	0	100	100
16	Y5	188/190 (99%)	182 (97%)	6 (3%)	0	100	100
16	y5	188/190 (99%)	184 (98%)	4 (2%)	0	100	100
17	0G	87/89 (98%)	84 (97%)	3 (3%)	0	100	100
17	51	87/89 (98%)	81 (93%)	6 (7%)	0	100	100
17	Y0	87/89 (98%)	81 (93%)	6 (7%)	0	100	100
17	y0	87/89 (98%)	84 (97%)	3 (3%)	0	100	100
18	0H	95/100 (95%)	95 (100%)	0	0	100	100
18	52	95/100 (95%)	94 (99%)	1 (1%)	0	100	100
18	Z1	95/100 (95%)	94 (99%)	1 (1%)	0	100	100
18	z1	95/100 (95%)	95 (100%)	0	0	100	100
21	10	206/231 (89%)	200 (97%)	6 (3%)	0	100	100
21	65	206/231 (89%)	202 (98%)	4 (2%)	0	100	100
21	K	206/231 (89%)	200 (97%)	6 (3%)	0	100	100
21	k	206/231 (89%)	200 (97%)	6 (3%)	0	100	100
22	11	192/222 (86%)	188 (98%)	4 (2%)	0	100	100
22	66	192/222 (86%)	188 (98%)	4 (2%)	0	100	100
22	L	192/222 (86%)	188 (98%)	4 (2%)	0	100	100
22	l	192/222 (86%)	188 (98%)	4 (2%)	0	100	100
23	12	217/220 (99%)	209 (96%)	8 (4%)	0	100	100
23	67	217/220 (99%)	206 (95%)	11 (5%)	0	100	100
23	M	217/220 (99%)	209 (96%)	8 (4%)	0	100	100
23	m	217/220 (99%)	206 (95%)	11 (5%)	0	100	100
24	13	204/210 (97%)	201 (98%)	3 (2%)	0	100	100
24	68	204/210 (97%)	198 (97%)	6 (3%)	0	100	100
24	N	204/210 (97%)	200 (98%)	4 (2%)	0	100	100

*Continued on next page...*

*Continued from previous page...*

Mol	Chain	Analysed	Favoured	Allowed	Outliers	Percentiles	
24	n	204/210 (97%)	198 (97%)	6 (3%)	0	100	100
25	14	127/193 (66%)	126 (99%)	1 (1%)	0	100	100
25	69	127/193 (66%)	126 (99%)	1 (1%)	0	100	100
25	O	127/193 (66%)	126 (99%)	1 (1%)	0	100	100
25	o	127/193 (66%)	126 (99%)	1 (1%)	0	100	100
26	15	173/175 (99%)	172 (99%)	1 (1%)	0	100	100
26	70	173/175 (99%)	171 (99%)	2 (1%)	0	100	100
26	P	173/175 (99%)	172 (99%)	1 (1%)	0	100	100
26	p	173/175 (99%)	171 (99%)	2 (1%)	0	100	100
27	16	171/173 (99%)	168 (98%)	3 (2%)	0	100	100
27	71	171/173 (99%)	165 (96%)	6 (4%)	0	100	100
27	Q	171/173 (99%)	168 (98%)	3 (2%)	0	100	100
27	q	171/173 (99%)	165 (96%)	6 (4%)	0	100	100
28	17	170/173 (98%)	162 (95%)	8 (5%)	0	100	100
28	72	170/173 (98%)	164 (96%)	6 (4%)	0	100	100
28	R	170/173 (98%)	162 (95%)	8 (5%)	0	100	100
28	r	170/173 (98%)	164 (96%)	6 (4%)	0	100	100
29	18	167/170 (98%)	162 (97%)	4 (2%)	1 (1%)	25	64
29	73	167/170 (98%)	161 (96%)	5 (3%)	1 (1%)	25	64
29	S	167/170 (98%)	162 (97%)	4 (2%)	1 (1%)	25	64
29	s	167/170 (98%)	161 (96%)	5 (3%)	1 (1%)	25	64
30	19	154/158 (98%)	149 (97%)	5 (3%)	0	100	100
30	74	154/158 (98%)	151 (98%)	3 (2%)	0	100	100
30	T	154/158 (98%)	149 (97%)	5 (3%)	0	100	100
30	t	154/158 (98%)	151 (98%)	3 (2%)	0	100	100
31	1B	57/59 (97%)	55 (96%)	2 (4%)	0	100	100
31	1b	57/59 (97%)	55 (96%)	2 (4%)	0	100	100
32	20	151/154 (98%)	146 (97%)	5 (3%)	0	100	100
32	75	151/154 (98%)	146 (97%)	5 (3%)	0	100	100
32	U	151/154 (98%)	146 (97%)	5 (3%)	0	100	100
32	u	151/154 (98%)	146 (97%)	5 (3%)	0	100	100

*Continued on next page...*

*Continued from previous page...*

Mol	Chain	Analysed	Favoured	Allowed	Outliers	Percentiles	
33	21	144/149 (97%)	136 (94%)	8 (6%)	0	100	100
33	76	144/149 (97%)	138 (96%)	6 (4%)	0	100	100
33	V	144/149 (97%)	136 (94%)	8 (6%)	0	100	100
33	v	144/149 (97%)	138 (96%)	6 (4%)	0	100	100
34	22	121/124 (98%)	119 (98%)	2 (2%)	0	100	100
34	77	121/124 (98%)	119 (98%)	2 (2%)	0	100	100
34	W	121/124 (98%)	119 (98%)	2 (2%)	0	100	100
34	w	121/124 (98%)	119 (98%)	2 (2%)	0	100	100
35	23	120/122 (98%)	119 (99%)	1 (1%)	0	100	100
35	78	120/122 (98%)	119 (99%)	1 (1%)	0	100	100
35	X	120/122 (98%)	119 (99%)	1 (1%)	0	100	100
35	x	120/122 (98%)	119 (99%)	1 (1%)	0	100	100
36	24	103/105 (98%)	101 (98%)	2 (2%)	0	100	100
36	79	103/105 (98%)	102 (99%)	1 (1%)	0	100	100
36	Y	103/105 (98%)	101 (98%)	2 (2%)	0	100	100
36	y	103/105 (98%)	102 (99%)	1 (1%)	0	100	100
37	25	85/90 (94%)	84 (99%)	1 (1%)	0	100	100
37	80	85/90 (94%)	84 (99%)	1 (1%)	0	100	100
37	Z	85/90 (94%)	84 (99%)	1 (1%)	0	100	100
37	z	85/90 (94%)	84 (99%)	1 (1%)	0	100	100
38	26	672/688 (98%)	654 (97%)	18 (3%)	0	100	100
38	81	672/688 (98%)	651 (97%)	21 (3%)	0	100	100
38	C1	672/688 (98%)	654 (97%)	18 (3%)	0	100	100
38	c1	672/688 (98%)	651 (97%)	21 (3%)	0	100	100
39	27	595/604 (98%)	574 (96%)	20 (3%)	1 (0%)	47	80
39	82	595/604 (98%)	572 (96%)	23 (4%)	0	100	100
39	C2	595/604 (98%)	574 (96%)	20 (3%)	1 (0%)	47	80
39	c2	595/604 (98%)	572 (96%)	23 (4%)	0	100	100
40	28	580/594 (98%)	557 (96%)	23 (4%)	0	100	100
40	83	580/594 (98%)	559 (96%)	21 (4%)	0	100	100
40	C3	580/594 (98%)	558 (96%)	22 (4%)	0	100	100

*Continued on next page...*

*Continued from previous page...*

Mol	Chain	Analysed	Favoured	Allowed	Outliers	Percentiles	
40	c3	580/594 (98%)	559 (96%)	21 (4%)	0	100	100
41	29	551/637 (86%)	538 (98%)	13 (2%)	0	100	100
41	84	551/637 (86%)	532 (97%)	19 (3%)	0	100	100
41	VB	551/637 (86%)	538 (98%)	13 (2%)	0	100	100
41	vb	551/637 (86%)	532 (97%)	19 (3%)	0	100	100
42	2B	176/178 (99%)	171 (97%)	5 (3%)	0	100	100
42	2b	176/178 (99%)	171 (97%)	5 (3%)	0	100	100
43	2E	319/322 (99%)	305 (96%)	14 (4%)	0	100	100
43	2e	319/322 (99%)	305 (96%)	14 (4%)	0	100	100
44	2F	215/296 (73%)	212 (99%)	3 (1%)	0	100	100
44	2f	215/296 (73%)	212 (99%)	3 (1%)	0	100	100
45	2G	196/198 (99%)	189 (96%)	7 (4%)	0	100	100
45	2g	196/198 (99%)	189 (96%)	7 (4%)	0	100	100
46	2H	98/195 (50%)	94 (96%)	4 (4%)	0	100	100
46	2h	98/195 (50%)	94 (96%)	4 (4%)	0	100	100
47	2I	112/114 (98%)	108 (96%)	4 (4%)	0	100	100
47	2i	112/114 (98%)	108 (96%)	4 (4%)	0	100	100
48	2J	100/103 (97%)	98 (98%)	2 (2%)	0	100	100
48	2j	100/103 (97%)	98 (98%)	2 (2%)	0	100	100
49	2K	91/93 (98%)	87 (96%)	4 (4%)	0	100	100
49	2k	91/93 (98%)	87 (96%)	4 (4%)	0	100	100
50	2L	81/89 (91%)	81 (100%)	0	0	100	100
50	2l	81/89 (91%)	81 (100%)	0	0	100	100
51	2M	73/76 (96%)	67 (92%)	6 (8%)	0	100	100
51	2m	73/76 (96%)	67 (92%)	6 (8%)	0	100	100
52	2N	59/62 (95%)	53 (90%)	5 (8%)	1 (2%)	9	44
52	2n	59/62 (95%)	53 (90%)	5 (8%)	1 (2%)	9	44
53	2O	40/46 (87%)	40 (100%)	0	0	100	100
53	2o	40/46 (87%)	40 (100%)	0	0	100	100
54	30	124/130 (95%)	118 (95%)	6 (5%)	0	100	100
54	6A	124/130 (95%)	118 (95%)	6 (5%)	0	100	100

*Continued on next page...*



*Continued from previous page...*

Mol	Chain	Analysed	Favoured	Allowed	Outliers	Percentiles	
54	6a	124/130 (95%)	119 (96%)	5 (4%)	0	100	100
54	85	124/130 (95%)	119 (96%)	5 (4%)	0	100	100
55	31	220/230 (96%)	213 (97%)	7 (3%)	0	100	100
55	6B	220/230 (96%)	213 (97%)	7 (3%)	0	100	100
55	6b	220/230 (96%)	208 (94%)	12 (6%)	0	100	100
55	86	220/230 (96%)	208 (94%)	12 (6%)	0	100	100
56	32	99/103 (96%)	94 (95%)	5 (5%)	0	100	100
56	6C	99/103 (96%)	94 (95%)	5 (5%)	0	100	100
56	6c	99/103 (96%)	96 (97%)	3 (3%)	0	100	100
56	87	99/103 (96%)	96 (97%)	3 (3%)	0	100	100
57	33	75/88 (85%)	75 (100%)	0	0	100	100
57	6L	75/88 (85%)	74 (99%)	1 (1%)	0	100	100
57	6l	75/88 (85%)	71 (95%)	4 (5%)	0	100	100
57	88	75/88 (85%)	71 (95%)	4 (5%)	0	100	100
58	34	131/133 (98%)	128 (98%)	3 (2%)	0	100	100
58	7A	131/133 (98%)	128 (98%)	3 (2%)	0	100	100
58	7a	131/133 (98%)	127 (97%)	4 (3%)	0	100	100
58	89	131/133 (98%)	127 (97%)	4 (3%)	0	100	100
59	35	208/236 (88%)	203 (98%)	4 (2%)	1 (0%)	29	68
59	7C	208/236 (88%)	203 (98%)	4 (2%)	1 (0%)	29	68
59	7c	208/236 (88%)	201 (97%)	7 (3%)	0	100	100
59	90	208/236 (88%)	201 (97%)	7 (3%)	0	100	100
60	36	129/990 (13%)	122 (95%)	7 (5%)	0	100	100
60	7L	129/990 (13%)	122 (95%)	7 (5%)	0	100	100
60	7l	129/990 (13%)	121 (94%)	8 (6%)	0	100	100
60	91	129/990 (13%)	121 (94%)	8 (6%)	0	100	100
61	37	344/346 (99%)	331 (96%)	13 (4%)	0	100	100
61	92	344/346 (99%)	335 (97%)	9 (3%)	0	100	100
61	M1	344/346 (99%)	331 (96%)	13 (4%)	0	100	100
61	m1	344/346 (99%)	335 (97%)	9 (3%)	0	100	100
62	38	316/318 (99%)	306 (97%)	10 (3%)	0	100	100

*Continued on next page...*

*Continued from previous page...*

Mol	Chain	Analysed	Favoured	Allowed	Outliers	Percentiles	
62	93	316/318 (99%)	312 (99%)	4 (1%)	0	100	100
62	M2	316/318 (99%)	306 (97%)	10 (3%)	0	100	100
62	m2	316/318 (99%)	311 (98%)	5 (2%)	0	100	100
63	39	327/330 (99%)	313 (96%)	14 (4%)	0	100	100
63	94	327/330 (99%)	319 (98%)	8 (2%)	0	100	100
63	M3	327/330 (99%)	313 (96%)	14 (4%)	0	100	100
63	m3	327/330 (99%)	319 (98%)	8 (2%)	0	100	100
64	1T	68/72 (94%)	66 (97%)	2 (3%)	0	100	100
64	1t	68/72 (94%)	66 (97%)	2 (3%)	0	100	100
64	40	68/72 (94%)	66 (97%)	2 (3%)	0	100	100
64	95	68/72 (94%)	67 (98%)	1 (2%)	0	100	100
65	2T	68/72 (94%)	68 (100%)	0	0	100	100
65	2t	68/72 (94%)	68 (100%)	0	0	100	100
65	41	68/72 (94%)	68 (100%)	0	0	100	100
65	96	68/72 (94%)	68 (100%)	0	0	100	100
66	3T	81/93 (87%)	78 (96%)	3 (4%)	0	100	100
66	3t	81/93 (87%)	80 (99%)	1 (1%)	0	100	100
66	42	81/93 (87%)	78 (96%)	3 (4%)	0	100	100
66	97	81/93 (87%)	80 (99%)	1 (1%)	0	100	100
67	43	55/68 (81%)	54 (98%)	1 (2%)	0	100	100
67	4T	55/68 (81%)	54 (98%)	1 (2%)	0	100	100
67	4t	55/68 (81%)	53 (96%)	2 (4%)	0	100	100
67	98	55/68 (81%)	53 (96%)	2 (4%)	0	100	100
68	44	60/81 (74%)	59 (98%)	1 (2%)	0	100	100
68	5T	60/81 (74%)	59 (98%)	1 (2%)	0	100	100
68	5t	60/81 (74%)	60 (100%)	0	0	100	100
68	99	60/81 (74%)	60 (100%)	0	0	100	100
69	4L	114/116 (98%)	113 (99%)	1 (1%)	0	100	100
69	4l	114/116 (98%)	113 (99%)	1 (1%)	0	100	100
70	5B	98/100 (98%)	94 (96%)	4 (4%)	0	100	100
70	5b	98/100 (98%)	94 (96%)	4 (4%)	0	100	100

*Continued on next page...*

*Continued from previous page...*

Mol	Chain	Analysed	Favoured	Allowed	Outliers	Percentiles	
71	A1	91/94 (97%)	89 (98%)	2 (2%)	0	100	100
71	a1	91/94 (97%)	89 (98%)	2 (2%)	0	100	100
72	A2	96/103 (93%)	95 (99%)	1 (1%)	0	100	100
72	a2	96/103 (93%)	95 (99%)	1 (1%)	0	100	100
73	A3	127/135 (94%)	124 (98%)	3 (2%)	0	100	100
73	a3	127/135 (94%)	124 (98%)	3 (2%)	0	100	100
74	A5	153/206 (74%)	153 (100%)	0	0	100	100
74	a5	153/206 (74%)	153 (100%)	0	0	100	100
75	A6	170/172 (99%)	167 (98%)	3 (2%)	0	100	100
75	a6	170/172 (99%)	167 (98%)	3 (2%)	0	100	100
76	A7	280/282 (99%)	277 (99%)	3 (1%)	0	100	100
76	a7	280/282 (99%)	277 (99%)	3 (1%)	0	100	100
77	A8	130/238 (55%)	128 (98%)	2 (2%)	0	100	100
77	a8	130/238 (55%)	128 (98%)	2 (2%)	0	100	100
78	A9	338/362 (93%)	325 (96%)	13 (4%)	0	100	100
78	a9	338/362 (93%)	325 (96%)	13 (4%)	0	100	100
79	AB	110/138 (80%)	110 (100%)	0	0	100	100
79	ab	110/138 (80%)	109 (99%)	1 (1%)	0	100	100
80	AC	96/133 (72%)	92 (96%)	4 (4%)	0	100	100
80	ac	96/133 (72%)	92 (96%)	4 (4%)	0	100	100
81	AL	191/194 (98%)	184 (96%)	7 (4%)	0	100	100
81	al	191/194 (98%)	184 (96%)	7 (4%)	0	100	100
82	AM	158/175 (90%)	151 (96%)	7 (4%)	0	100	100
82	am	158/175 (90%)	151 (96%)	7 (4%)	0	100	100
83	AN	229/231 (99%)	224 (98%)	5 (2%)	0	100	100
83	an	229/231 (99%)	224 (98%)	5 (2%)	0	100	100
84	B2	118/126 (94%)	114 (97%)	4 (3%)	0	100	100
84	b2	118/126 (94%)	114 (97%)	4 (3%)	0	100	100
85	B3	67/83 (81%)	64 (96%)	3 (4%)	0	100	100
85	b3	67/83 (81%)	64 (96%)	3 (4%)	0	100	100
86	B4	113/147 (77%)	111 (98%)	2 (2%)	0	100	100

*Continued on next page...*

Continued from previous page...

Mol	Chain	Analysed	Favoured	Allowed	Outliers	Percentiles	
86	b4	113/147 (77%)	111 (98%)	2 (2%)	0	100	100
87	B6	68/129 (53%)	67 (98%)	1 (2%)	0	100	100
87	b6	68/129 (53%)	67 (98%)	1 (2%)	0	100	100
88	B7	114/120 (95%)	112 (98%)	2 (2%)	0	100	100
88	b7	114/120 (95%)	112 (98%)	2 (2%)	0	100	100
89	B8	173/207 (84%)	165 (95%)	8 (5%)	0	100	100
89	b8	173/207 (84%)	165 (95%)	8 (5%)	0	100	100
90	B9	186/189 (98%)	178 (96%)	8 (4%)	0	100	100
90	b9	186/189 (98%)	178 (96%)	8 (4%)	0	100	100
91	BL	173/188 (92%)	169 (98%)	4 (2%)	0	100	100
91	bl	173/188 (92%)	169 (98%)	4 (2%)	0	100	100
92	BM	162/214 (76%)	156 (96%)	6 (4%)	0	100	100
92	bm	162/214 (76%)	156 (96%)	6 (4%)	0	100	100
93	C4	100/102 (98%)	96 (96%)	4 (4%)	0	100	100
93	c4	100/102 (98%)	96 (96%)	4 (4%)	0	100	100
94	FX	144/172 (84%)	139 (96%)	5 (4%)	0	100	100
94	fx	144/172 (84%)	139 (96%)	5 (4%)	0	100	100
95	G1	227/257 (88%)	220 (97%)	7 (3%)	0	100	100
95	g1	227/257 (88%)	220 (97%)	7 (3%)	0	100	100
96	G2	228/233 (98%)	225 (99%)	3 (1%)	0	100	100
96	g2	228/233 (98%)	225 (99%)	3 (1%)	0	100	100
97	G3	344/346 (99%)	336 (98%)	8 (2%)	0	100	100
97	g3	344/346 (99%)	336 (98%)	8 (2%)	0	100	100
98	J1	259/317 (82%)	252 (97%)	7 (3%)	0	100	100
98	j1	259/317 (82%)	252 (97%)	7 (3%)	0	100	100
99	N1	281/284 (99%)	271 (96%)	9 (3%)	1 (0%)	34	71
99	n1	281/284 (99%)	272 (97%)	8 (3%)	1 (0%)	34	71
100	N2	358/360 (99%)	354 (99%)	4 (1%)	0	100	100
100	n2	358/360 (99%)	354 (99%)	4 (1%)	0	100	100
101	N3	118/121 (98%)	115 (98%)	3 (2%)	0	100	100
101	n3	118/121 (98%)	115 (98%)	3 (2%)	0	100	100

Continued on next page...

*Continued from previous page...*

Mol	Chain	Analysed	Favoured	Allowed	Outliers	Percentiles	
102	N4	503/505 (100%)	492 (98%)	11 (2%)	0	100	100
102	n4	503/505 (100%)	492 (98%)	11 (2%)	0	100	100
103	N5	707/750 (94%)	682 (96%)	25 (4%)	0	100	100
103	n5	707/750 (94%)	682 (96%)	25 (4%)	0	100	100
104	N6	253/255 (99%)	248 (98%)	5 (2%)	0	100	100
104	n6	253/255 (99%)	248 (98%)	5 (2%)	0	100	100
105	P1	228/251 (91%)	223 (98%)	5 (2%)	0	100	100
105	p1	228/251 (91%)	223 (98%)	5 (2%)	0	100	100
106	P2	165/189 (87%)	159 (96%)	6 (4%)	0	100	100
106	p2	165/189 (87%)	159 (96%)	6 (4%)	0	100	100
107	QA	450/482 (93%)	441 (98%)	9 (2%)	0	100	100
107	Qa	450/482 (93%)	437 (97%)	13 (3%)	0	100	100
107	qA	450/482 (93%)	441 (98%)	9 (2%)	0	100	100
107	qa	450/482 (93%)	437 (97%)	13 (3%)	0	100	100
108	QB	478/513 (93%)	463 (97%)	15 (3%)	0	100	100
108	Qb	478/513 (93%)	461 (96%)	17 (4%)	0	100	100
108	qB	478/513 (93%)	462 (97%)	16 (3%)	0	100	100
108	qb	478/513 (93%)	461 (96%)	17 (4%)	0	100	100
109	QC	424/426 (100%)	405 (96%)	19 (4%)	0	100	100
109	Qc	423/426 (99%)	404 (96%)	19 (4%)	0	100	100
109	qC	424/426 (100%)	405 (96%)	19 (4%)	0	100	100
109	qc	423/426 (99%)	404 (96%)	19 (4%)	0	100	100
110	QD	293/319 (92%)	282 (96%)	11 (4%)	0	100	100
110	Qd	293/319 (92%)	276 (94%)	17 (6%)	0	100	100
110	qD	293/319 (92%)	282 (96%)	11 (4%)	0	100	100
110	qd	293/319 (92%)	276 (94%)	17 (6%)	0	100	100
111	QE	226/269 (84%)	212 (94%)	13 (6%)	1 (0%)	34	71
111	Qe	215/269 (80%)	200 (93%)	14 (6%)	1 (0%)	29	68
111	qE	226/269 (84%)	212 (94%)	13 (6%)	1 (0%)	34	71
111	qe	215/269 (80%)	201 (94%)	13 (6%)	1 (0%)	29	68
112	QF	87/90 (97%)	84 (97%)	3 (3%)	0	100	100

*Continued on next page...*

*Continued from previous page...*

Mol	Chain	Analysed	Favoured	Allowed	Outliers	Percentiles	
112	Qf	78/90 (87%)	75 (96%)	3 (4%)	0	100	100
112	qF	87/90 (97%)	84 (97%)	3 (3%)	0	100	100
112	qf	78/90 (87%)	75 (96%)	3 (4%)	0	100	100
113	QG	325/328 (99%)	315 (97%)	10 (3%)	0	100	100
113	Qg	324/328 (99%)	316 (98%)	8 (2%)	0	100	100
113	qG	325/328 (99%)	315 (97%)	10 (3%)	0	100	100
113	qg	324/328 (99%)	317 (98%)	7 (2%)	0	100	100
114	QH	127/130 (98%)	124 (98%)	3 (2%)	0	100	100
114	Qh	127/130 (98%)	122 (96%)	5 (4%)	0	100	100
114	qH	127/130 (98%)	124 (98%)	3 (2%)	0	100	100
114	qh	127/130 (98%)	122 (96%)	5 (4%)	0	100	100
115	QI	112/119 (94%)	106 (95%)	6 (5%)	0	100	100
115	Qi	112/119 (94%)	112 (100%)	0	0	100	100
115	qI	112/119 (94%)	106 (95%)	6 (5%)	0	100	100
115	qi	112/119 (94%)	112 (100%)	0	0	100	100
116	QJ	54/62 (87%)	54 (100%)	0	0	100	100
116	Qj	56/62 (90%)	55 (98%)	1 (2%)	0	100	100
116	qJ	54/62 (87%)	54 (100%)	0	0	100	100
116	qj	56/62 (90%)	55 (98%)	1 (2%)	0	100	100
117	QL	30/41 (73%)	30 (100%)	0	0	100	100
117	Ql	30/41 (73%)	29 (97%)	1 (3%)	0	100	100
117	qL	30/41 (73%)	30 (100%)	0	0	100	100
117	ql	30/41 (73%)	29 (97%)	1 (3%)	0	100	100
118	S1	687/718 (96%)	663 (96%)	24 (4%)	0	100	100
118	s1	687/718 (96%)	663 (96%)	24 (4%)	0	100	100
119	S2	440/442 (100%)	426 (97%)	14 (3%)	0	100	100
119	s2	440/442 (100%)	425 (97%)	15 (3%)	0	100	100
120	S3	196/198 (99%)	188 (96%)	8 (4%)	0	100	100
120	s3	196/198 (99%)	188 (96%)	8 (4%)	0	100	100
121	S4	180/185 (97%)	176 (98%)	4 (2%)	0	100	100
121	s4	180/185 (97%)	176 (98%)	4 (2%)	0	100	100

*Continued on next page...*

*Continued from previous page...*

Mol	Chain	Analysed	Favoured	Allowed	Outliers	Percentiles	
122	S5	91/94 (97%)	88 (97%)	3 (3%)	0	100	100
122	s5	91/94 (97%)	88 (97%)	3 (3%)	0	100	100
123	S6	90/132 (68%)	85 (94%)	5 (6%)	0	100	100
123	s6	90/132 (68%)	85 (94%)	5 (6%)	0	100	100
124	S7	159/162 (98%)	153 (96%)	6 (4%)	0	100	100
124	s7	159/162 (98%)	153 (96%)	6 (4%)	0	100	100
125	S8	216/236 (92%)	211 (98%)	5 (2%)	0	100	100
125	s8	216/236 (92%)	211 (98%)	5 (2%)	0	100	100
126	SA	597/636 (94%)	573 (96%)	24 (4%)	0	100	100
126	sa	597/636 (94%)	573 (96%)	24 (4%)	0	100	100
127	SB	277/312 (89%)	263 (95%)	14 (5%)	0	100	100
127	sb	277/312 (89%)	263 (95%)	14 (5%)	0	100	100
128	SC	56/60 (93%)	53 (95%)	3 (5%)	0	100	100
128	sc	56/60 (93%)	53 (95%)	3 (5%)	0	100	100
129	SD	42/44 (96%)	42 (100%)	0	0	100	100
129	sd	42/44 (96%)	42 (100%)	0	0	100	100
130	T1	500/516 (97%)	491 (98%)	9 (2%)	0	100	100
130	t1	500/516 (97%)	491 (98%)	9 (2%)	0	100	100
131	T2	277/333 (83%)	268 (97%)	8 (3%)	1 (0%)	34	71
131	t2	277/333 (83%)	268 (97%)	8 (3%)	1 (0%)	34	71
132	T3	308/311 (99%)	300 (97%)	8 (3%)	0	100	100
132	t3	308/311 (99%)	300 (97%)	8 (3%)	0	100	100
133	T4	196/212 (92%)	190 (97%)	6 (3%)	0	100	100
133	t4	196/212 (92%)	190 (97%)	6 (3%)	0	100	100
134	T5	139/205 (68%)	137 (99%)	2 (1%)	0	100	100
134	t5	139/205 (68%)	137 (99%)	2 (1%)	0	100	100
135	T6	107/144 (74%)	105 (98%)	2 (2%)	0	100	100
135	t6	107/144 (74%)	105 (98%)	2 (2%)	0	100	100
136	T7	140/143 (98%)	137 (98%)	3 (2%)	0	100	100
136	t7	140/143 (98%)	137 (98%)	3 (2%)	0	100	100
137	T8	129/135 (96%)	125 (97%)	4 (3%)	0	100	100

*Continued on next page...*

*Continued from previous page...*

Mol	Chain	Analysed	Favoured	Allowed	Outliers	Percentiles	
137	t8	129/135 (96%)	125 (97%)	4 (3%)	0	100	100
138	T9	130/136 (96%)	125 (96%)	5 (4%)	0	100	100
138	t9	130/136 (96%)	125 (96%)	5 (4%)	0	100	100
139	TA	100/127 (79%)	97 (97%)	3 (3%)	0	100	100
139	ta	100/127 (79%)	97 (97%)	3 (3%)	0	100	100
140	TB	94/113 (83%)	94 (100%)	0	0	100	100
140	tb	94/113 (83%)	94 (100%)	0	0	100	100
141	TC	90/93 (97%)	89 (99%)	1 (1%)	0	100	100
141	tc	90/93 (97%)	89 (99%)	1 (1%)	0	100	100
142	TD	70/73 (96%)	69 (99%)	1 (1%)	0	100	100
142	td	70/73 (96%)	69 (99%)	1 (1%)	0	100	100
143	TE	48/71 (68%)	44 (92%)	4 (8%)	0	100	100
143	te	48/71 (68%)	44 (92%)	4 (8%)	0	100	100
144	TF	214/236 (91%)	210 (98%)	4 (2%)	0	100	100
144	tf	214/236 (91%)	210 (98%)	4 (2%)	0	100	100
145	TG	132/135 (98%)	130 (98%)	2 (2%)	0	100	100
145	tg	132/135 (98%)	130 (98%)	2 (2%)	0	100	100
146	TH	122/124 (98%)	121 (99%)	1 (1%)	0	100	100
146	th	122/124 (98%)	121 (99%)	1 (1%)	0	100	100
147	TX	142/166 (86%)	140 (99%)	2 (1%)	0	100	100
147	tx	142/166 (86%)	140 (99%)	2 (1%)	0	100	100
148	V1	440/474 (93%)	423 (96%)	17 (4%)	0	100	100
148	v1	440/474 (93%)	423 (96%)	17 (4%)	0	100	100
149	V2	229/274 (84%)	220 (96%)	9 (4%)	0	100	100
149	v2	229/274 (84%)	220 (96%)	9 (4%)	0	100	100
150	X1	147/150 (98%)	146 (99%)	1 (1%)	0	100	100
150	x1	147/150 (98%)	146 (99%)	1 (1%)	0	100	100
All	All	88644/100386 (88%)	85881 (97%)	2737 (3%)	26 (0%)	100	100

5 of 26 Ramachandran outliers are listed below:

Mol	Chain	Res	Type
3	02	87	PRO

*Continued on next page...*



*Continued from previous page...*

Mol	Chain	Res	Type
3	57	87	PRO
131	t2	77	LYS
131	T2	77	LYS
3	c	87	PRO

### 5.3.2 Protein sidechains [i](#)

There are no protein residues with a non-rotameric sidechain to report in this entry.

### 5.3.3 RNA [i](#)

There are no RNA molecules in this entry.

## 5.4 Non-standard residues in protein, DNA, RNA chains [i](#)

12 non-standard protein/DNA/RNA residues are modelled in this entry.

In the following table, the Counts columns list the number of bonds (or angles) for which Mogul statistics could be retrieved, the number of bonds (or angles) that are observed in the model and the number of bonds (or angles) that are defined in the Chemical Component Dictionary. The Link column lists molecule types, if any, to which the group is linked. The Z score for a bond length (or angle) is the number of standard deviations the observed value is removed from the expected value. A bond length (or angle) with  $|Z| > 2$  is considered an outlier worth inspection. RMSZ is the root-mean-square of all Z scores of the bond lengths (or angles).

Mol	Type	Chain	Res	Link	Bond lengths			Bond angles		
					Counts	RMSZ	# Z  > 2	Counts	RMSZ	# Z  > 2
41	TPO	VB	387	41	8,10,11	1.21	1 (12%)	10,14,16	1.04	0
59	SEP	90	120	59	8,9,10	0.87	0	8,12,14	1.09	1 (12%)
41	SEP	84	520	41	8,9,10	0.87	0	8,12,14	0.81	0
41	SEP	29	520	41	8,9,10	0.88	0	8,12,14	0.72	0
59	SEP	35	120	59	8,9,10	0.88	0	8,12,14	0.98	0
59	SEP	7c	120	59	8,9,10	0.87	0	8,12,14	1.09	1 (12%)
41	SEP	vb	520	41	8,9,10	0.87	0	8,12,14	0.80	0
41	TPO	29	387	41	8,10,11	1.21	1 (12%)	10,14,16	1.06	0
59	SEP	7C	120	59	8,9,10	0.88	0	8,12,14	1.00	0
41	SEP	VB	520	41	8,9,10	0.87	0	8,12,14	0.72	0
41	TPO	84	387	41	8,10,11	1.26	1 (12%)	10,14,16	1.05	1 (10%)
41	TPO	vb	387	41	8,10,11	1.25	1 (12%)	10,14,16	1.05	1 (10%)

In the following table, the Chirals column lists the number of chiral outliers, the number of chiral centers analysed, the number of these observed in the model and the number defined in the Chemical Component Dictionary. Similar counts are reported in the Torsion and Rings columns. '-' means no outliers of that kind were identified.

Mol	Type	Chain	Res	Link	Chirals	Torsions	Rings
41	TPO	VB	387	41	-	1/9/11/13	-
59	SEP	90	120	59	-	3/5/8/10	-
41	SEP	84	520	41	-	4/5/8/10	-
41	SEP	29	520	41	-	3/5/8/10	-
59	SEP	35	120	59	-	3/5/8/10	-
59	SEP	7c	120	59	-	3/5/8/10	-
41	SEP	vb	520	41	-	4/5/8/10	-
41	TPO	29	387	41	-	1/9/11/13	-
59	SEP	7C	120	59	-	3/5/8/10	-
41	SEP	VB	520	41	-	3/5/8/10	-
41	TPO	84	387	41	-	1/9/11/13	-
41	TPO	vb	387	41	-	1/9/11/13	-

All (4) bond length outliers are listed below:

Mol	Chain	Res	Type	Atoms	Z	Observed(Å)	Ideal(Å)
41	84	387	TPO	P-OG1	3.18	1.65	1.59
41	vb	387	TPO	P-OG1	3.14	1.65	1.59
41	29	387	TPO	P-OG1	3.02	1.65	1.59
41	VB	387	TPO	P-OG1	3.00	1.65	1.59

All (4) bond angle outliers are listed below:

Mol	Chain	Res	Type	Atoms	Z	Observed(°)	Ideal(°)
59	7c	120	SEP	OG-CB-CA	-2.34	105.87	108.14
59	90	120	SEP	OG-CB-CA	-2.33	105.88	108.14
41	84	387	TPO	CG2-CB-CA	-2.03	109.15	113.16
41	vb	387	TPO	CG2-CB-CA	-2.03	109.17	113.16

There are no chirality outliers.

5 of 30 torsion outliers are listed below:

Mol	Chain	Res	Type	Atoms
41	29	520	SEP	CB-OG-P-O1P
41	29	520	SEP	CB-OG-P-O2P
41	29	520	SEP	CB-OG-P-O3P

*Continued on next page...*

Continued from previous page...

Mol	Chain	Res	Type	Atoms
59	35	120	SEP	CB-OG-P-O1P
59	35	120	SEP	CB-OG-P-O2P

There are no ring outliers.

No monomer is involved in short contacts.

## 5.5 Carbohydrates [i](#)

There are no monosaccharides in this entry.

## 5.6 Ligand geometry [i](#)

Of 98 ligands modelled in this entry, 26 are monoatomic - leaving 72 for Mogul analysis.

In the following table, the Counts columns list the number of bonds (or angles) for which Mogul statistics could be retrieved, the number of bonds (or angles) that are observed in the model and the number of bonds (or angles) that are defined in the Chemical Component Dictionary. The Link column lists molecule types, if any, to which the group is linked. The Z score for a bond length (or angle) is the number of standard deviations the observed value is removed from the expected value. A bond length (or angle) with  $|Z| > 2$  is considered an outlier worth inspection. RMSZ is the root-mean-square of all Z scores of the bond lengths (or angles).

Mol	Type	Chain	Res	Link	Bond lengths			Bond angles		
					Counts	RMSZ	# Z  > 2	Counts	RMSZ	# Z  > 2
151	FES	47	201	-	0,4,4	-	-	-		
151	FES	0C	201	-	0,4,4	-	-	-		
159	ADP	B8	301	-	24,29,29	0.94	1 (4%)	29,45,45	1.47	4 (13%)
161	SF4	s7	201	-	0,12,12	-	-	-		
151	FES	Qe	301	-	0,4,4	-	-	-		
161	SF4	sb	402	-	0,12,12	-	-	-		
152	HEM	0F	201	-	41,50,50	1.22	4 (9%)	45,82,82	1.69	7 (15%)
161	SF4	s8	302	-	0,12,12	-	-	-		
151	FES	s1	803	-	0,4,4	-	-	-		
151	FES	V2	300	-	0,4,4	-	-	-		
158	NDP	a9	401	-	45,52,52	0.57	0	53,80,80	0.62	1 (1%)
161	SF4	s8	301	-	0,12,12	-	-	-		
152	HEM	50	201	-	41,50,50	1.21	4 (9%)	45,82,82	1.72	8 (17%)
164	FMN	v1	501	-	33,33,33	0.17	0	48,50,50	0.44	1 (2%)
157	HEC	qD	401	-	32,50,50	2.01	4 (12%)	24,82,82	2.42	15 (62%)
161	SF4	S8	302	-	0,12,12	-	-	-		

Mol	Type	Chain	Res	Link	Bond lengths			Bond angles		
					Counts	RMSZ	# Z  > 2	Counts	RMSZ	# Z  > 2
153	HEA	81	701	-	57,67,67	1.98	15 (26%)	61,103,103	2.72	24 (39%)
151	FES	fs	202	-	0,4,4	-	-	-		
161	SF4	s1	801	-	0,12,12	-	-	-		
164	FMN	V1	501	-	33,33,33	0.17	0	48,50,50	0.44	0
161	SF4	S8	301	-	0,12,12	-	-	-		
153	HEA	26	701	-	57,67,67	2.06	15 (26%)	61,103,103	2.85	29 (47%)
152	HEM	qc	502	-	41,50,50	1.25	5 (12%)	45,82,82	1.73	7 (15%)
151	FES	fx	201	-	0,4,4	-	-	-		
157	HEC	2E	401	-	32,50,50	1.98	4 (12%)	24,82,82	2.26	14 (58%)
160	U10	qc	501	-	25,25,63	2.25	5 (20%)	27,29,79	1.84	8 (29%)
162	FAD	SA	701	-	53,58,58	0.46	0	68,89,89	0.51	2 (2%)
163	F3S	SB	403	-	0,9,9	-	-	-		
153	HEA	C1	701	-	57,67,67	2.07	14 (24%)	61,103,103	2.85	28 (45%)
151	FES	FX	201	-	0,4,4	-	-	-		
151	FES	QE	301	-	0,4,4	-	-	-		
152	HEM	Y5	201	-	41,50,50	1.21	4 (9%)	45,82,82	1.73	8 (17%)
152	HEM	qC	502	-	41,50,50	1.23	4 (9%)	45,82,82	1.72	8 (17%)
163	F3S	sb	403	-	0,9,9	-	-	-		
151	FES	FS	201	-	0,4,4	-	-	-		
152	HEM	QC	501	-	41,50,50	1.24	4 (9%)	45,82,82	1.74	7 (15%)
161	SF4	S1	801	-	0,12,12	-	-	-		
160	U10	Qc	501	-	25,25,63	2.25	5 (20%)	27,29,79	1.85	8 (29%)
151	FES	sb	401	-	0,4,4	-	-	-		
151	FES	47	202	-	0,4,4	-	-	-		
161	SF4	S1	802	-	0,12,12	-	-	-		
151	FES	qE	301	-	0,4,4	-	-	-		
151	FES	0C	202	-	0,4,4	-	-	-		
153	HEA	c1	703	-	57,67,67	2.02	13 (22%)	61,103,103	2.69	27 (44%)
153	HEA	c1	701	-	57,67,67	1.98	15 (26%)	61,103,103	2.73	24 (39%)
161	SF4	S7	201	-	0,12,12	-	-	-		
152	HEM	Qc	502	-	41,50,50	1.25	5 (12%)	45,82,82	1.72	8 (17%)
151	FES	S1	803	-	0,4,4	-	-	-		
152	HEM	qC	501	-	41,50,50	1.24	4 (9%)	45,82,82	1.73	7 (15%)
152	HEM	y5	201	-	41,50,50	1.22	4 (9%)	45,82,82	1.68	8 (17%)
153	HEA	81	703	-	57,67,67	2.02	13 (22%)	61,103,103	2.69	27 (44%)
161	SF4	v1	500	-	0,12,12	-	-	-		
161	SF4	s1	802	-	0,12,12	-	-	-		
161	SF4	SB	402	-	0,12,12	-	-	-		
152	HEM	qc	503	-	41,50,50	1.22	3 (7%)	45,82,82	1.68	8 (17%)

Mol	Type	Chain	Res	Link	Bond lengths			Bond angles		
					Counts	RMSZ	# Z  > 2	Counts	RMSZ	# Z  > 2
158	NDP	A9	401	-	45,52,52	0.57	0	53,80,80	0.61	1 (1%)
152	HEM	QC	502	-	41,50,50	1.23	4 (9%)	45,82,82	1.71	7 (15%)
152	HEM	Qc	503	-	41,50,50	1.22	3 (7%)	45,82,82	1.69	8 (17%)
162	FAD	sa	701	-	53,58,58	0.46	0	68,89,89	0.51	2 (2%)
159	ADP	b8	301	-	24,29,29	0.94	1 (4%)	29,45,45	1.47	4 (13%)
151	FES	qe	301	-	0,4,4	-	-	-	-	-
153	HEA	26	702	-	57,67,67	2.04	16 (28%)	61,103,103	2.84	27 (44%)
157	HEC	qd	401	-	32,50,50	2.02	4 (12%)	24,82,82	2.23	13 (54%)
157	HEC	2e	401	-	32,50,50	1.98	4 (12%)	24,82,82	2.26	14 (58%)
151	FES	SB	401	-	0,4,4	-	-	-	-	-
151	FES	FS	202	-	0,4,4	-	-	-	-	-
157	HEC	QD	401	-	32,50,50	2.01	4 (12%)	24,82,82	2.42	15 (62%)
161	SF4	V1	500	-	0,12,12	-	-	-	-	-
151	FES	fs	201	-	0,4,4	-	-	-	-	-
153	HEA	C1	702	-	57,67,67	2.04	16 (28%)	61,103,103	2.84	27 (44%)
157	HEC	Qd	401	-	32,50,50	2.02	4 (12%)	24,82,82	2.23	13 (54%)
151	FES	v2	300	-	0,4,4	-	-	-	-	-

In the following table, the Chirals column lists the number of chiral outliers, the number of chiral centers analysed, the number of these observed in the model and the number defined in the Chemical Component Dictionary. Similar counts are reported in the Torsion and Rings columns. '-' means no outliers of that kind were identified.

Mol	Type	Chain	Res	Link	Chirals	Torsions	Rings
159	ADP	B8	301	-	-	5/12/32/32	0/3/3/3
151	FES	0C	201	-	-	-	0/1/1/1
151	FES	47	201	-	-	-	0/1/1/1
161	SF4	s7	201	-	-	-	0/6/5/5
151	FES	Qe	301	-	-	-	0/1/1/1
161	SF4	sb	402	-	-	-	0/6/5/5
152	HEM	0F	201	-	-	5/12/54/54	-
161	SF4	s8	302	-	-	-	0/6/5/5
151	FES	s1	803	-	-	-	0/1/1/1
151	FES	V2	300	-	-	-	0/1/1/1
158	NDP	a9	401	-	-	6/30/77/77	0/5/5/5
161	SF4	s8	301	-	-	-	0/6/5/5
152	HEM	50	201	-	-	4/12/54/54	-
164	FMN	v1	501	-	-	4/18/18/18	0/3/3/3
157	HEC	qD	401	-	-	7/10/54/54	-

Continued on next page...

*Continued from previous page...*

Mol	Type	Chain	Res	Link	Chirals	Torsions	Rings
161	SF4	S8	302	-	-	-	0/6/5/5
153	HEA	81	701	-	3/3/7/16	13/32/76/76	-
164	FMN	V1	501	-	-	4/18/18/18	0/3/3/3
151	FES	fs	202	-	-	-	0/1/1/1
161	SF4	s1	801	-	-	-	0/6/5/5
161	SF4	S8	301	-	-	-	0/6/5/5
153	HEA	26	701	-	3/3/7/16	11/32/76/76	-
152	HEM	qc	502	-	-	2/12/54/54	-
157	HEC	2E	401	-	-	3/10/54/54	-
162	FAD	SA	701	-	-	11/30/50/50	0/6/6/6
160	U10	qc	501	-	-	6/28/28/87	-
151	FES	fx	201	-	-	-	0/1/1/1
163	F3S	SB	403	-	-	-	0/3/3/3
153	HEA	C1	701	-	3/3/7/16	11/32/76/76	-
151	FES	FX	201	-	-	-	0/1/1/1
152	HEM	Y5	201	-	-	4/12/54/54	-
151	FES	QE	301	-	-	-	0/1/1/1
152	HEM	qC	502	-	-	5/12/54/54	-
163	F3S	sb	403	-	-	-	0/3/3/3
152	HEM	QC	501	-	-	4/12/54/54	-
151	FES	FS	201	-	-	-	0/1/1/1
161	SF4	S1	801	-	-	-	0/6/5/5
160	U10	Qc	501	-	-	6/28/28/87	-
151	FES	sb	401	-	-	-	0/1/1/1
151	FES	47	202	-	-	-	0/1/1/1
161	SF4	S1	802	-	-	-	0/6/5/5
151	FES	qE	301	-	-	-	0/1/1/1
151	FES	0C	202	-	-	-	0/1/1/1
153	HEA	c1	703	-	3/3/7/16	17/32/76/76	-
161	SF4	S7	201	-	-	-	0/6/5/5
152	HEM	Qc	502	-	-	2/12/54/54	-
152	HEM	qC	501	-	-	4/12/54/54	-
151	FES	S1	803	-	-	-	0/1/1/1
153	HEA	81	703	-	3/3/7/16	17/32/76/76	-
152	HEM	y5	201	-	-	5/12/54/54	-
161	SF4	v1	500	-	-	-	0/6/5/5
161	SF4	s1	802	-	-	-	0/6/5/5
161	SF4	SB	402	-	-	-	0/6/5/5

*Continued on next page...*

Continued from previous page...

Mol	Type	Chain	Res	Link	Chirals	Torsions	Rings
152	HEM	qc	503	-	-	6/12/54/54	-
158	NDP	A9	401	-	-	6/30/77/77	0/5/5/5
152	HEM	QC	502	-	-	5/12/54/54	-
152	HEM	Qc	503	-	-	6/12/54/54	-
162	FAD	sa	701	-	-	11/30/50/50	0/6/6/6
151	FES	v2	300	-	-	-	0/1/1/1
159	ADP	b8	301	-	-	4/12/32/32	0/3/3/3
151	FES	qe	301	-	-	-	0/1/1/1
153	HEA	26	702	-	3/3/7/16	10/32/76/76	-
157	HEC	qd	401	-	-	3/10/54/54	-
157	HEC	2e	401	-	-	3/10/54/54	-
151	FES	SB	401	-	-	-	0/1/1/1
151	FES	FS	202	-	-	-	0/1/1/1
157	HEC	QD	401	-	-	7/10/54/54	-
161	SF4	V1	500	-	-	-	0/6/5/5
151	FES	fs	201	-	-	-	0/1/1/1
153	HEA	C1	702	-	3/3/7/16	10/32/76/76	-
157	HEC	Qd	401	-	-	3/10/54/54	-
153	HEA	c1	701	-	3/3/7/16	13/32/76/76	-

The worst 5 of 201 bond length outliers are listed below:

Mol	Chain	Res	Type	Atoms	Z	Observed(Å)	Ideal(Å)
160	qc	501	U10	C6-C1	8.74	1.53	1.33
160	Qc	501	U10	C6-C1	8.72	1.53	1.33
157	Qd	401	HEC	C3C-C2C	-6.43	1.34	1.40
157	qd	401	HEC	C3C-C2C	-6.41	1.34	1.40
157	qD	401	HEC	C3C-C2C	-6.41	1.34	1.40

The worst 5 of 419 bond angle outliers are listed below:

Mol	Chain	Res	Type	Atoms	Z	Observed(°)	Ideal(°)
153	81	703	HEA	CAD-CBD-CGD	-8.56	95.19	113.60
153	c1	703	HEA	CAD-CBD-CGD	-8.54	95.24	113.60
153	26	702	HEA	CAD-CBD-CGD	-8.41	95.51	113.60
153	C1	702	HEA	CAD-CBD-CGD	-8.41	95.51	113.60
153	81	701	HEA	CAD-CBD-CGD	-8.06	96.26	113.60

5 of 24 chirality outliers are listed below:

Mol	Chain	Res	Type	Atom
153	26	701	HEA	NA
153	26	701	HEA	NB
153	26	701	HEA	ND
153	26	702	HEA	NA
153	26	702	HEA	NB

5 of 243 torsion outliers are listed below:

Mol	Chain	Res	Type	Atoms
152	0F	201	HEM	C2B-C3B-CAB-CBB
152	0F	201	HEM	C4B-C3B-CAB-CBB
152	50	201	HEM	C2B-C3B-CAB-CBB
152	50	201	HEM	C4B-C3B-CAB-CBB
152	qC	501	HEM	C2B-C3B-CAB-CBB

There are no ring outliers.

No monomer is involved in short contacts.

The following is a two-dimensional graphical depiction of Mogul quality analysis of bond lengths, bond angles, torsion angles, and ring geometry for all instances of the Ligand of Interest. In addition, ligands with molecular weight > 250 and outliers as shown on the validation Tables will also be included. For torsion angles, if less than 5% of the Mogul distribution of torsion angles is within 10 degrees of the torsion angle in question, then that torsion angle is considered an outlier. Any bond that is central to one or more torsion angles identified as an outlier by Mogul will be highlighted in the graph. For rings, the root-mean-square deviation (RMSD) between the ring in question and similar rings identified by Mogul is calculated over all ring torsion angles. If the average RMSD is greater than 60 degrees and the minimal RMSD between the ring in question and any Mogul-identified rings is also greater than 60 degrees, then that ring is considered an outlier. The outliers are highlighted in purple. The color gray indicates Mogul did not find sufficient equivalents in the CSD to analyse the geometry.



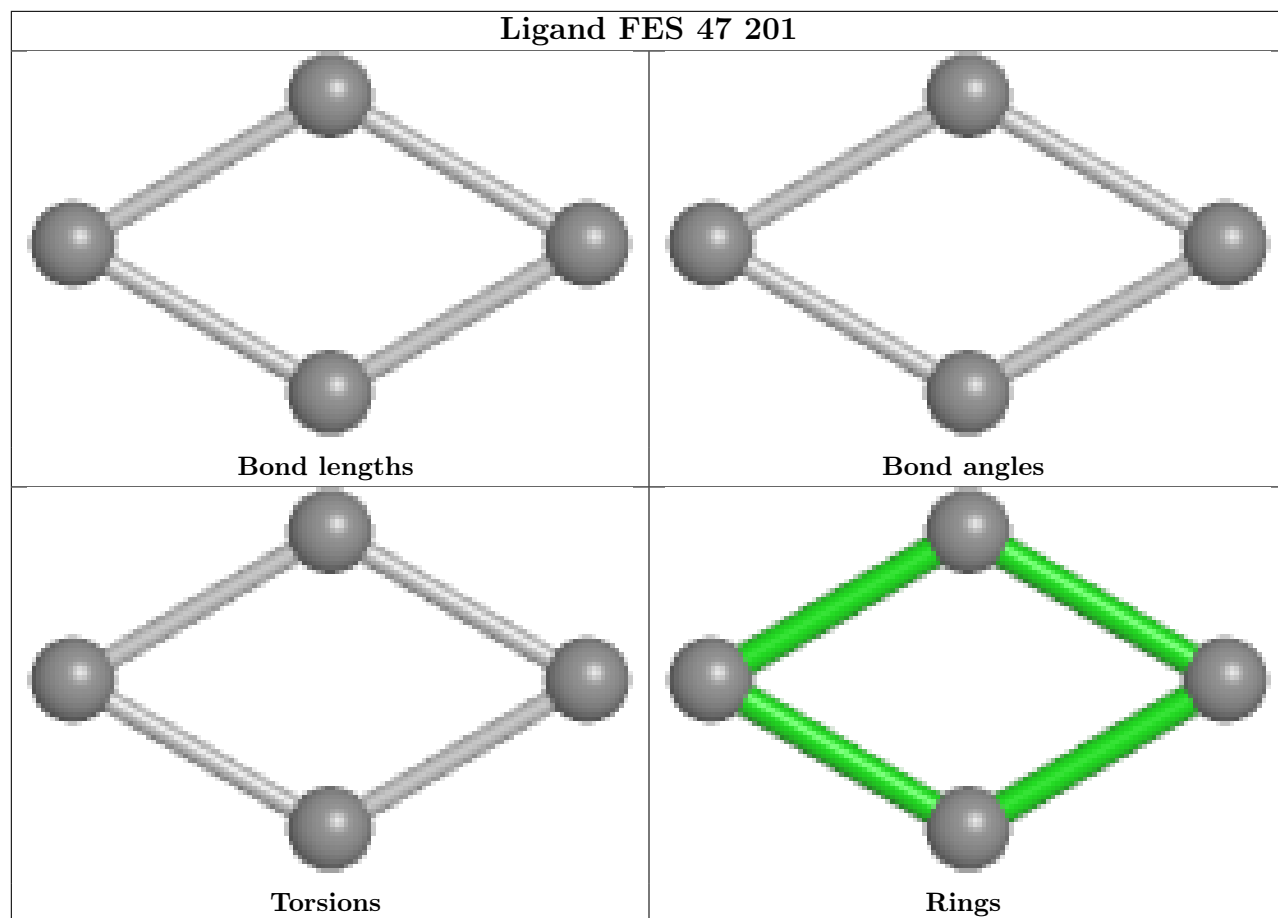

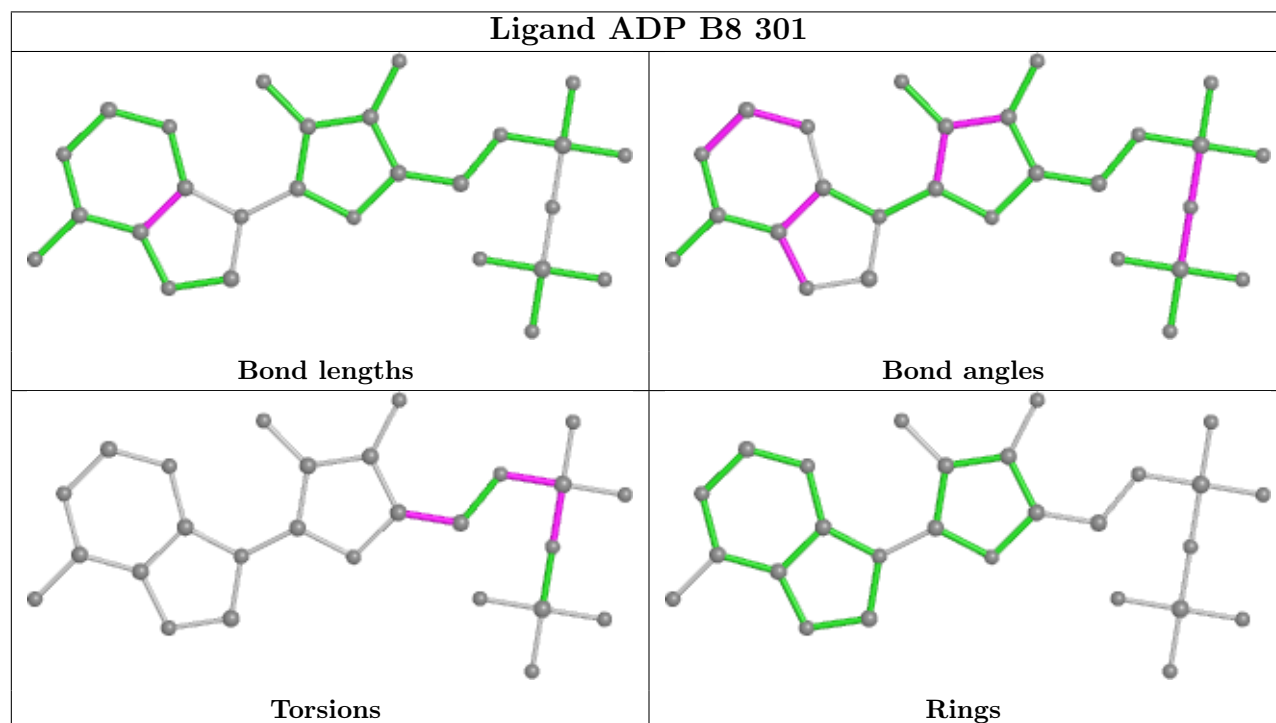
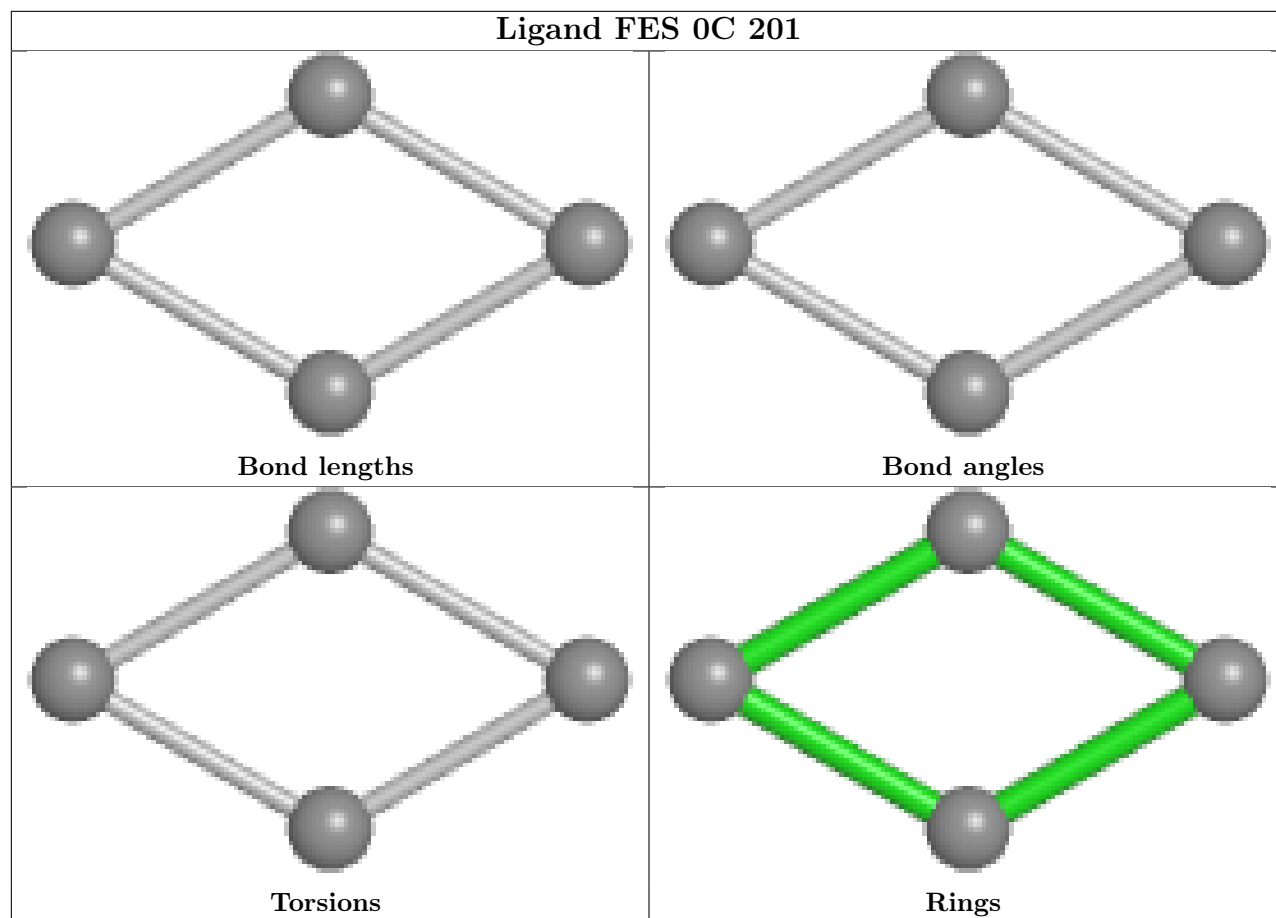

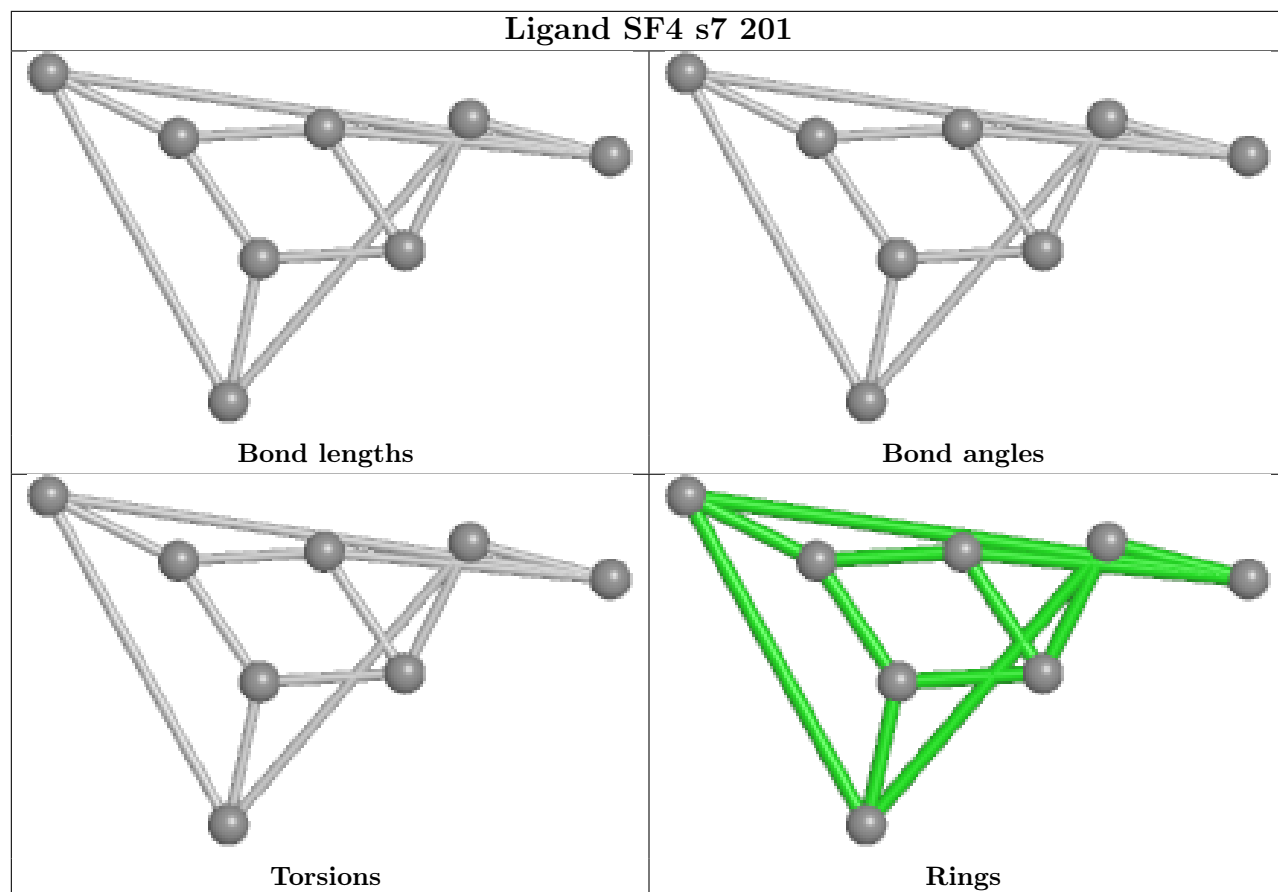

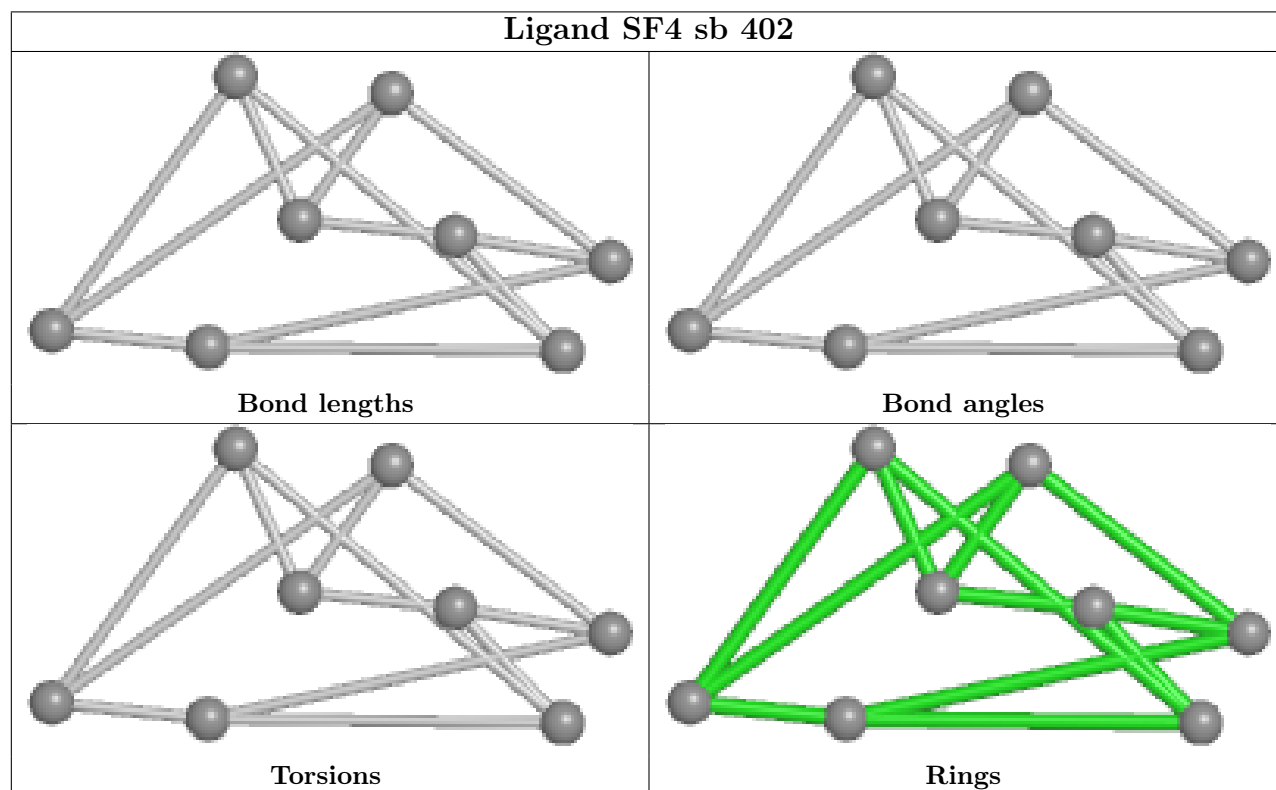
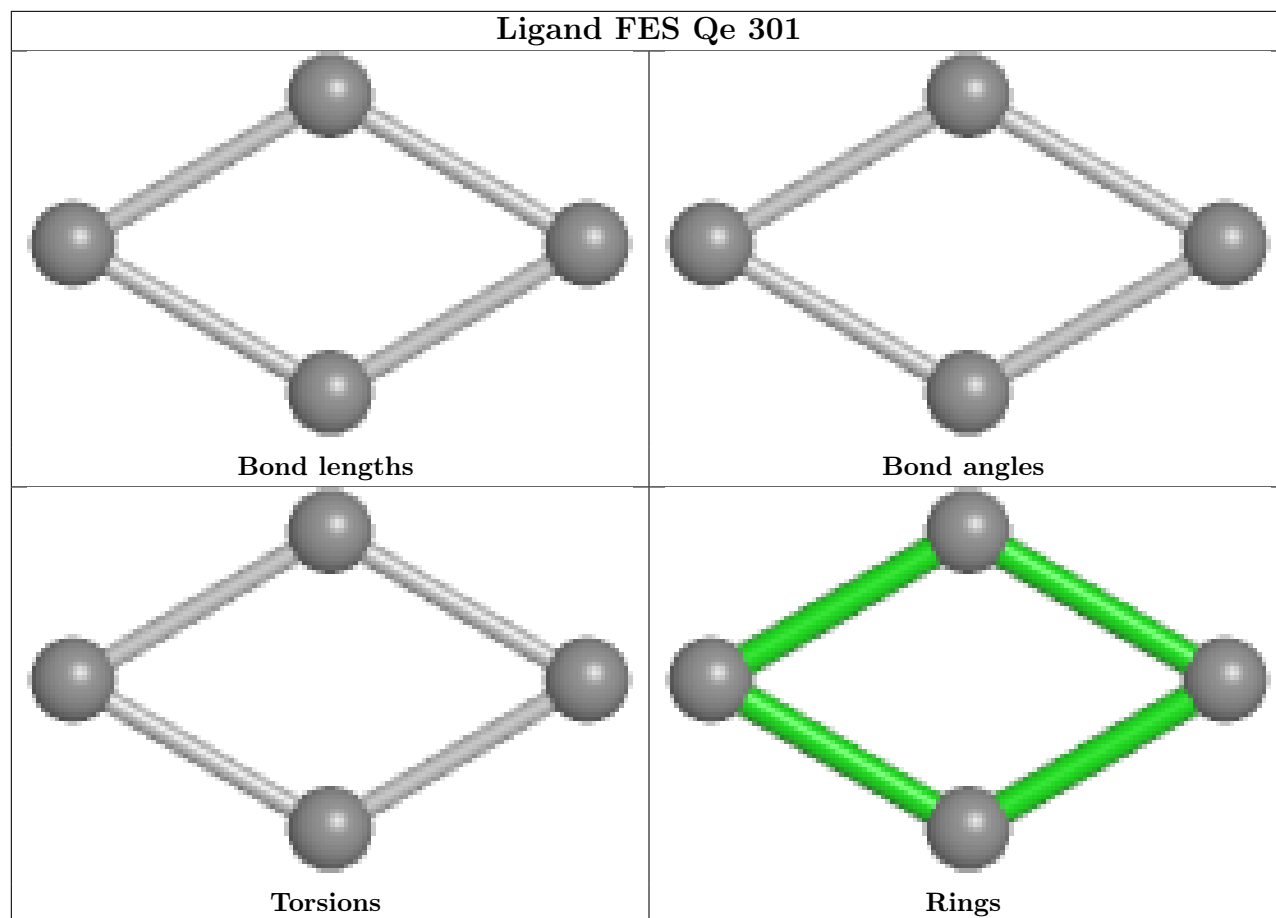

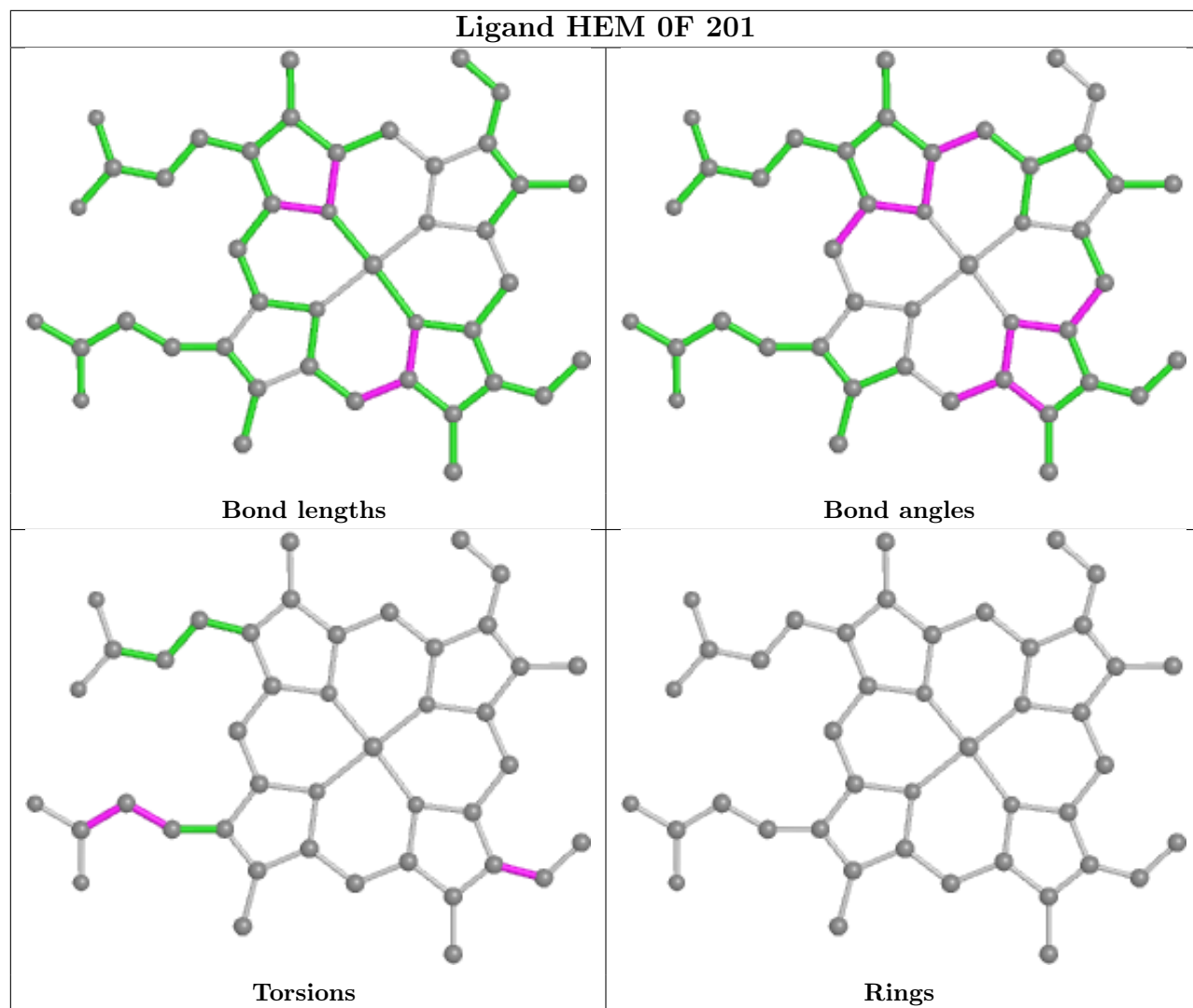

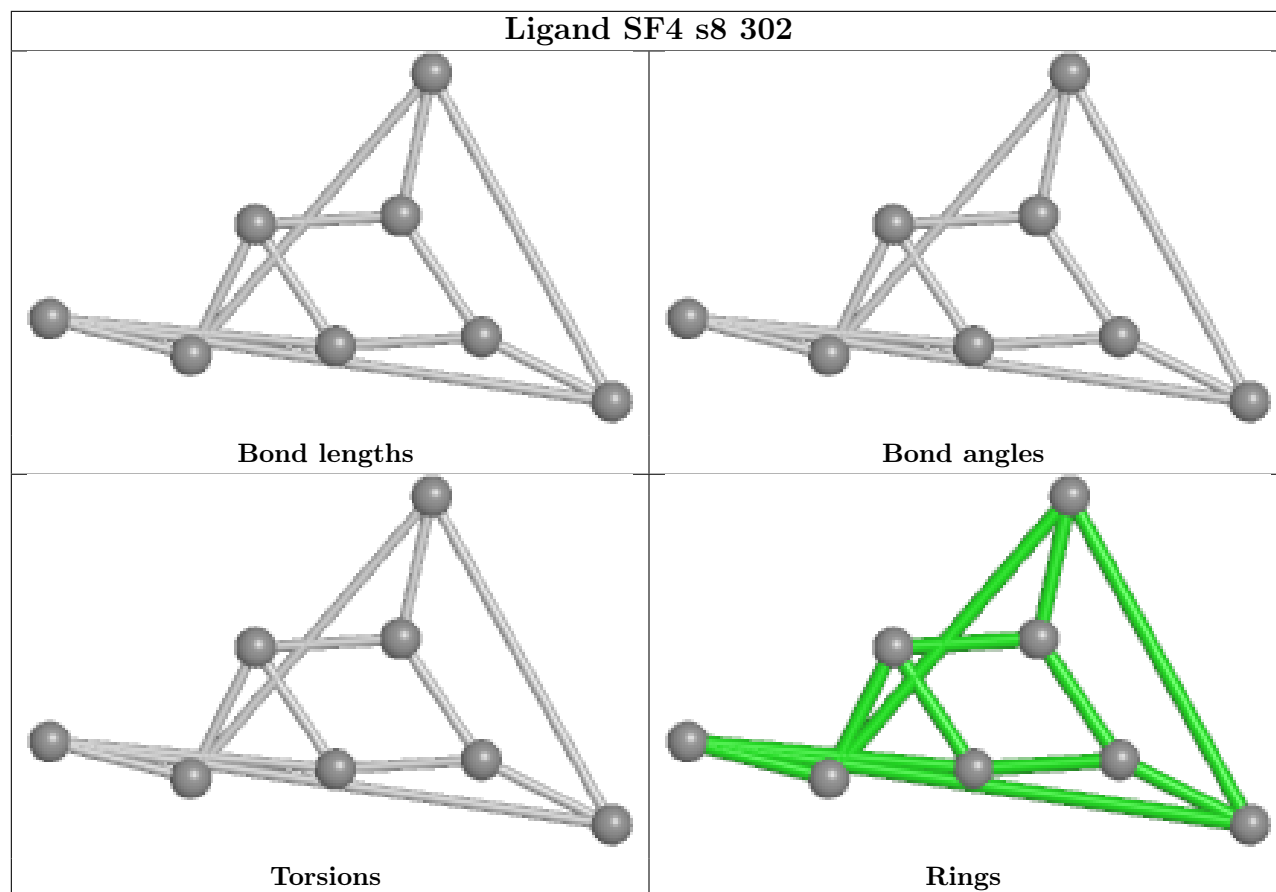

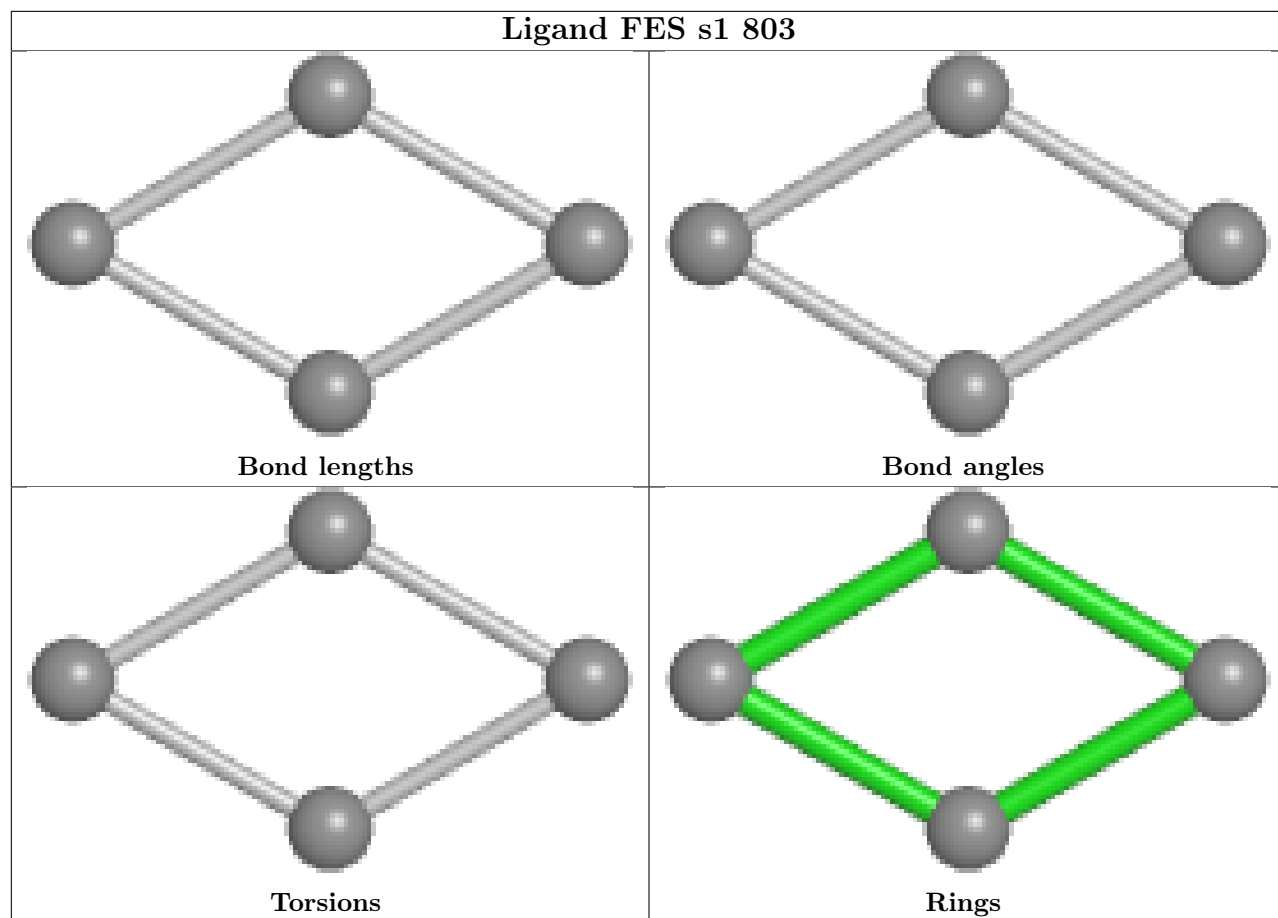

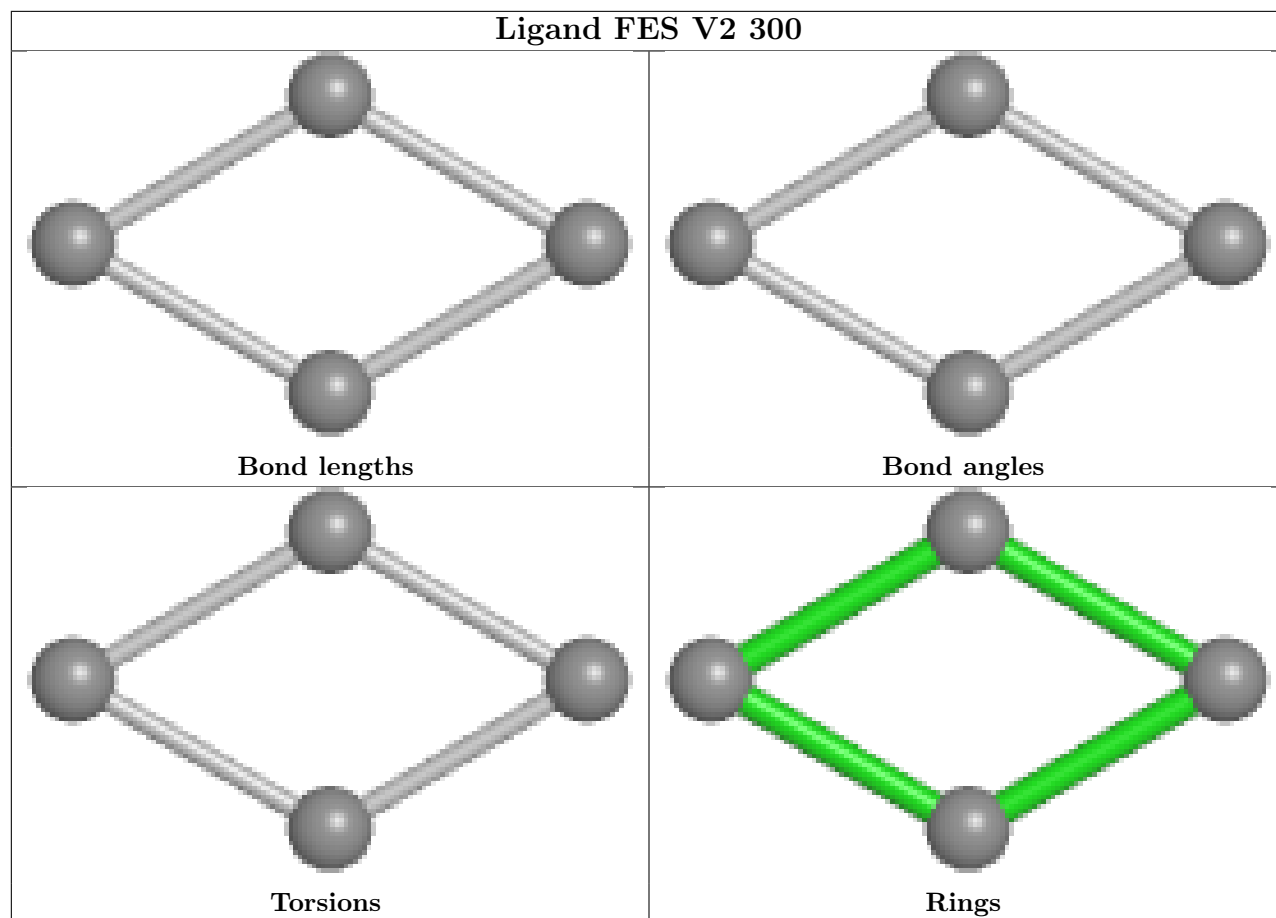



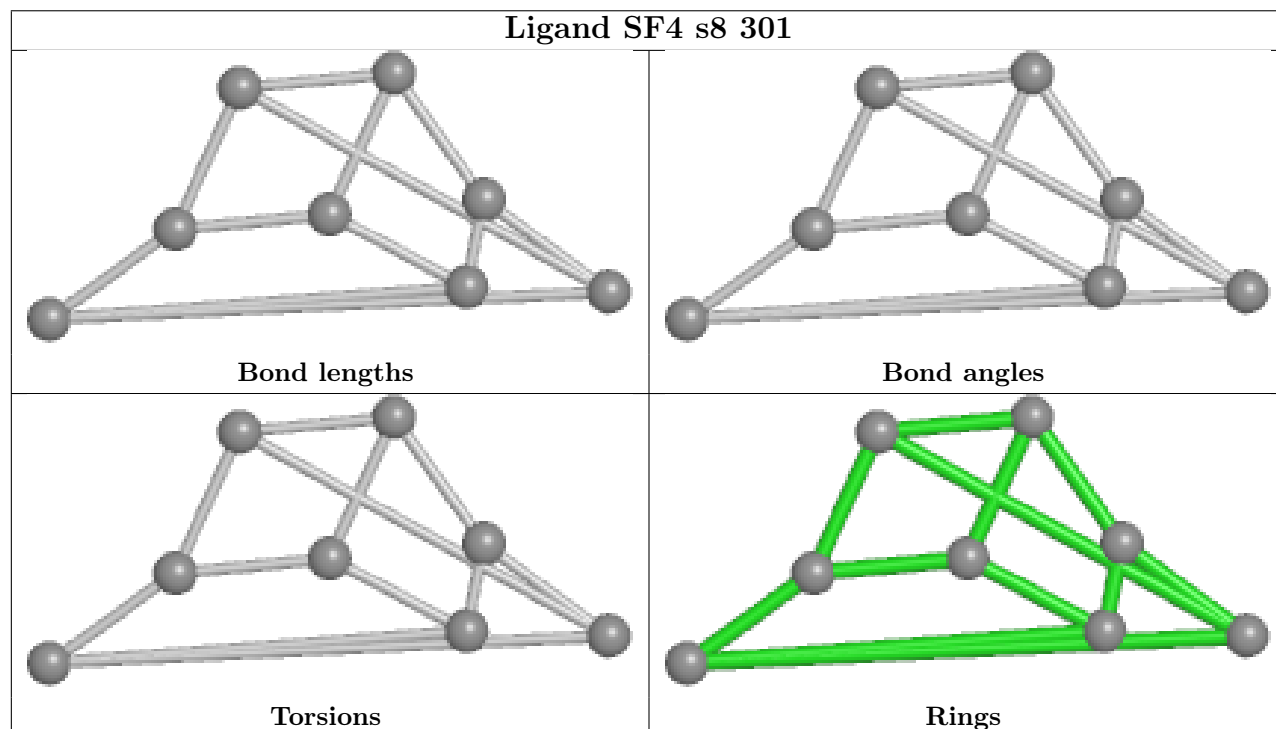
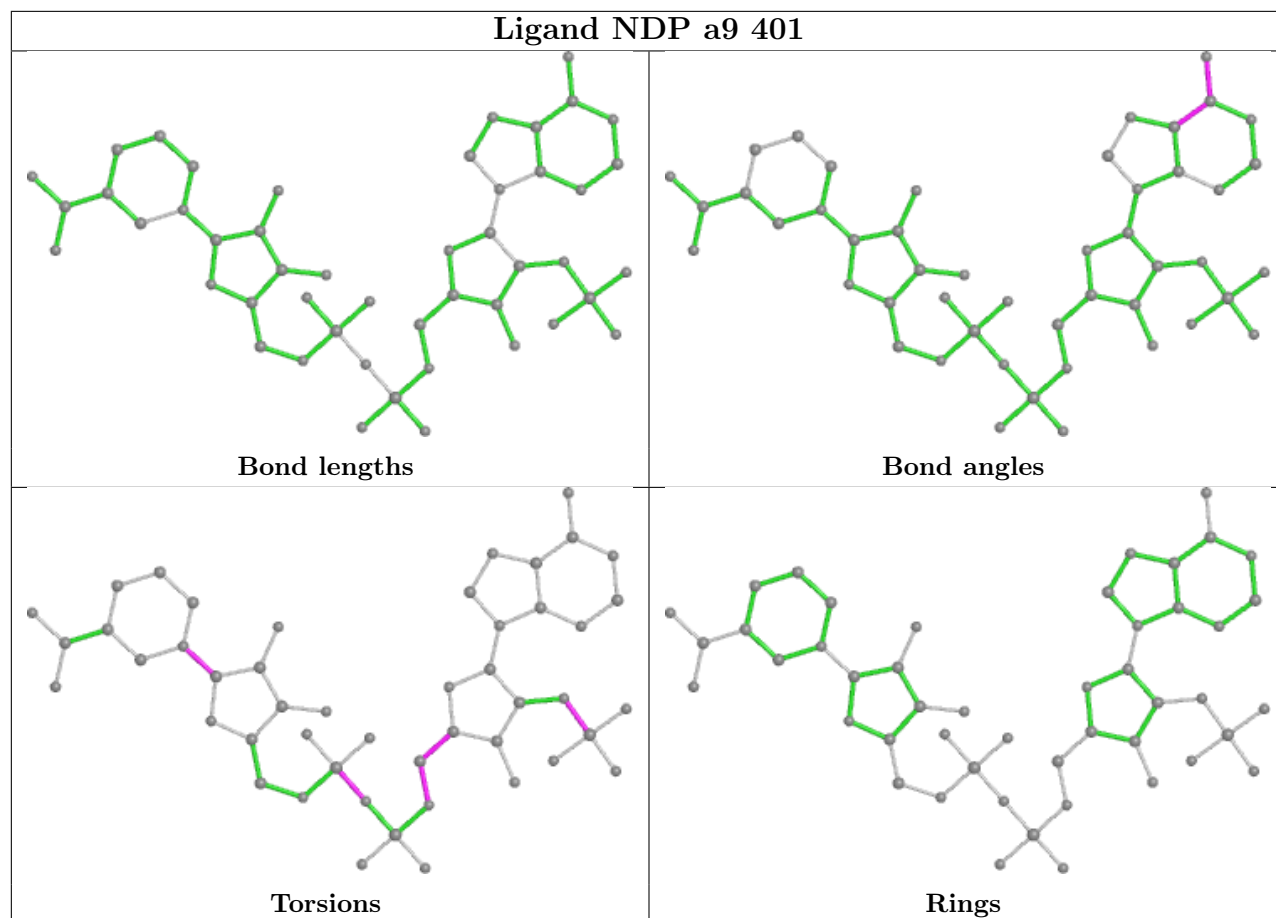

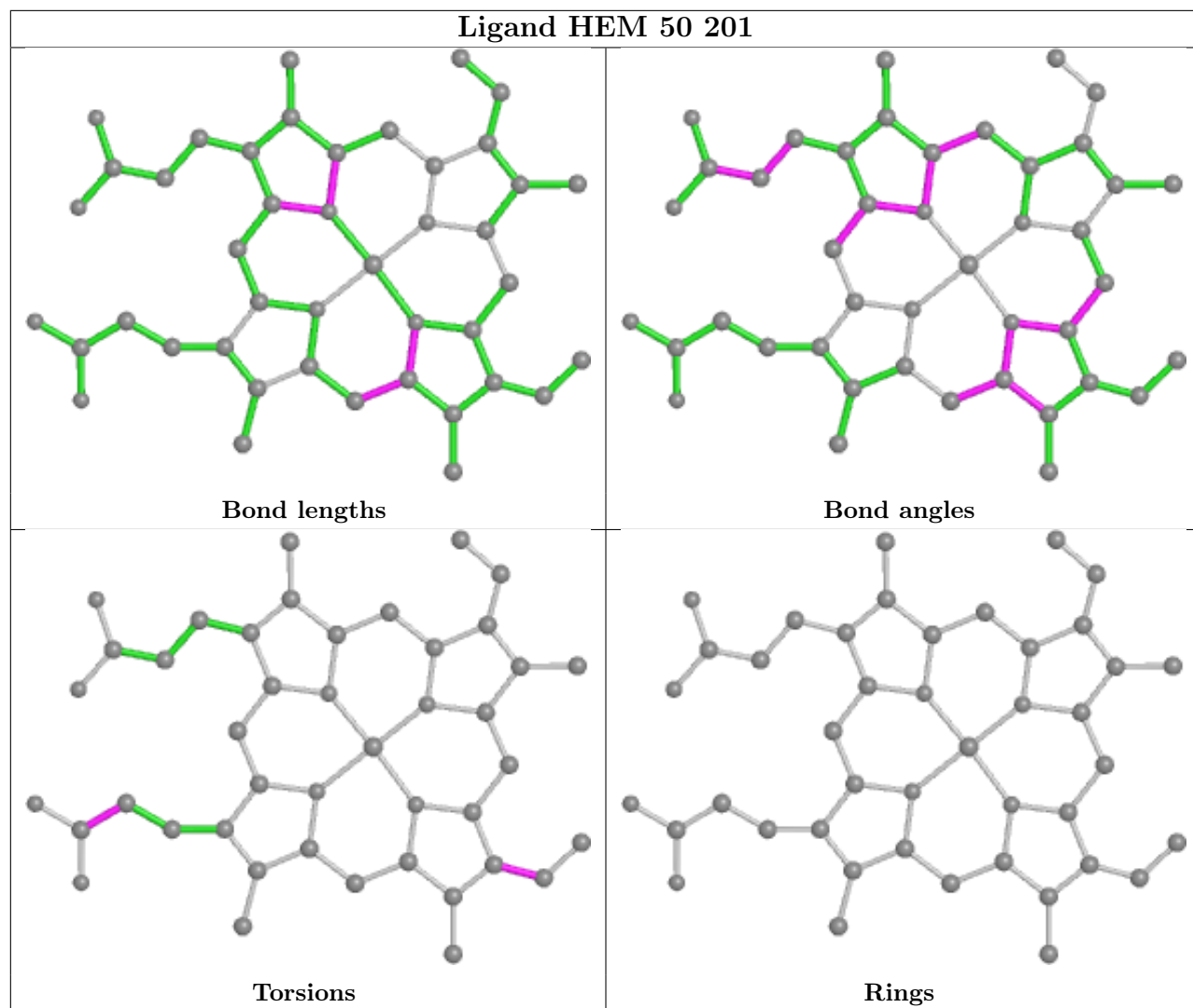

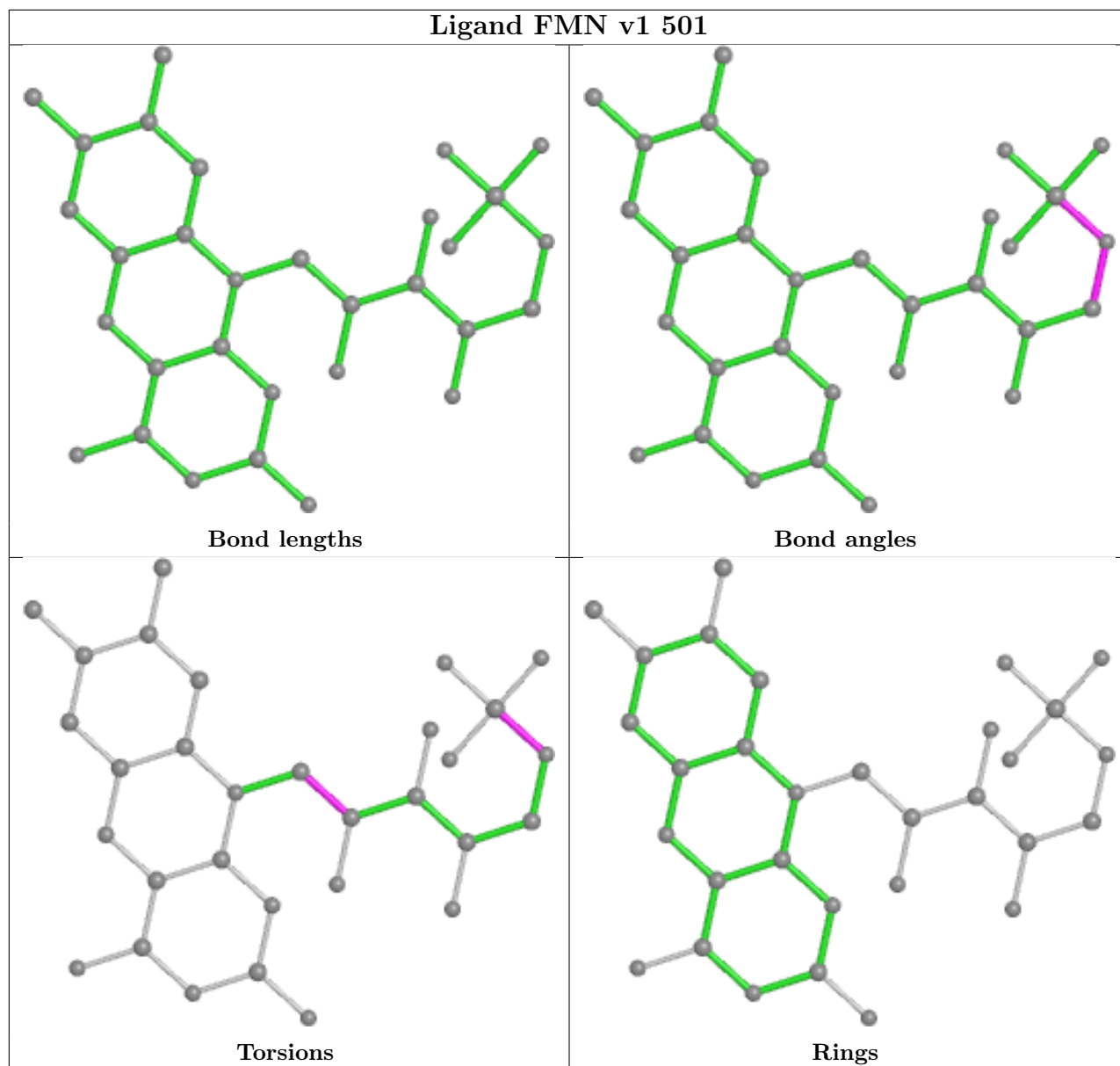

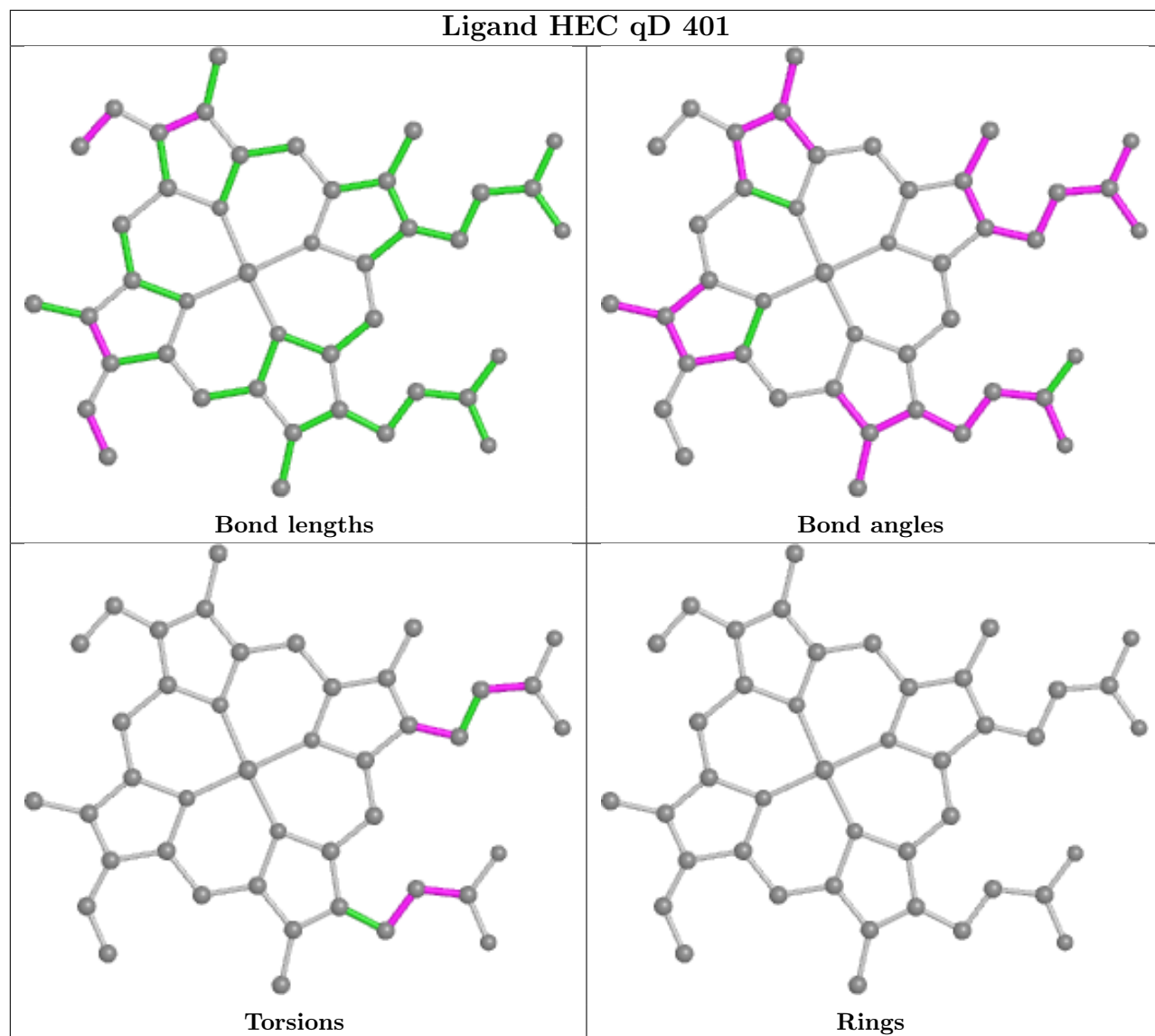

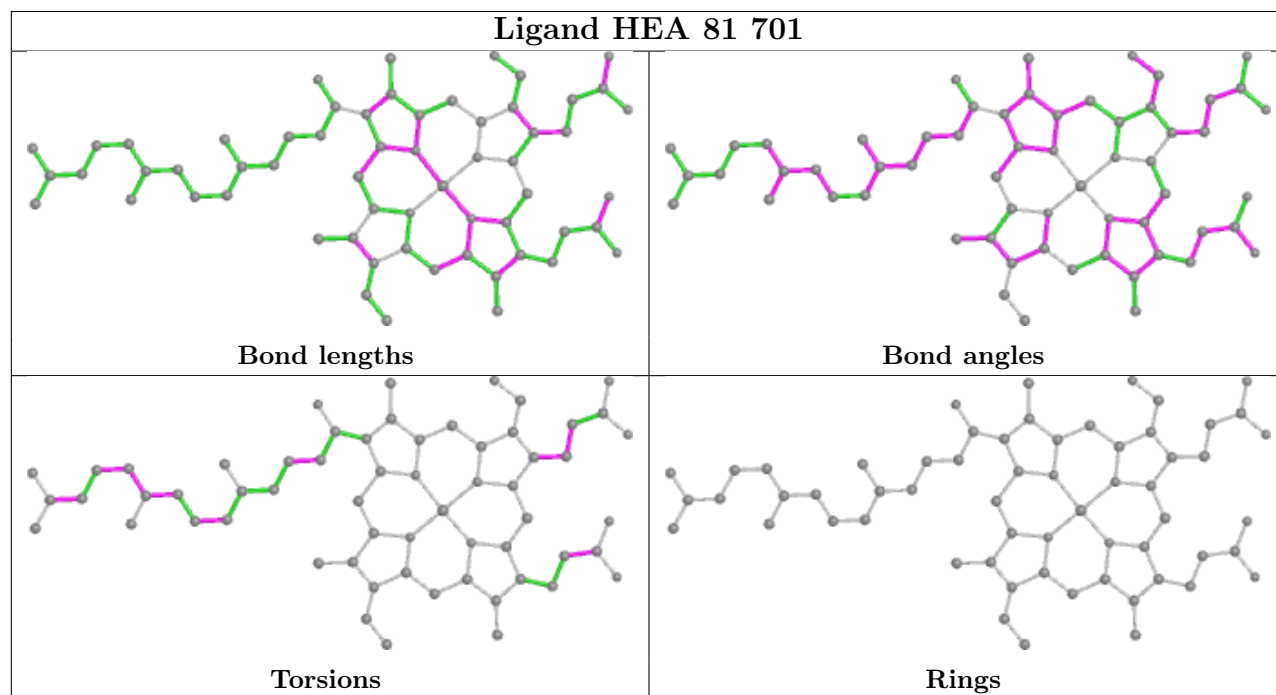
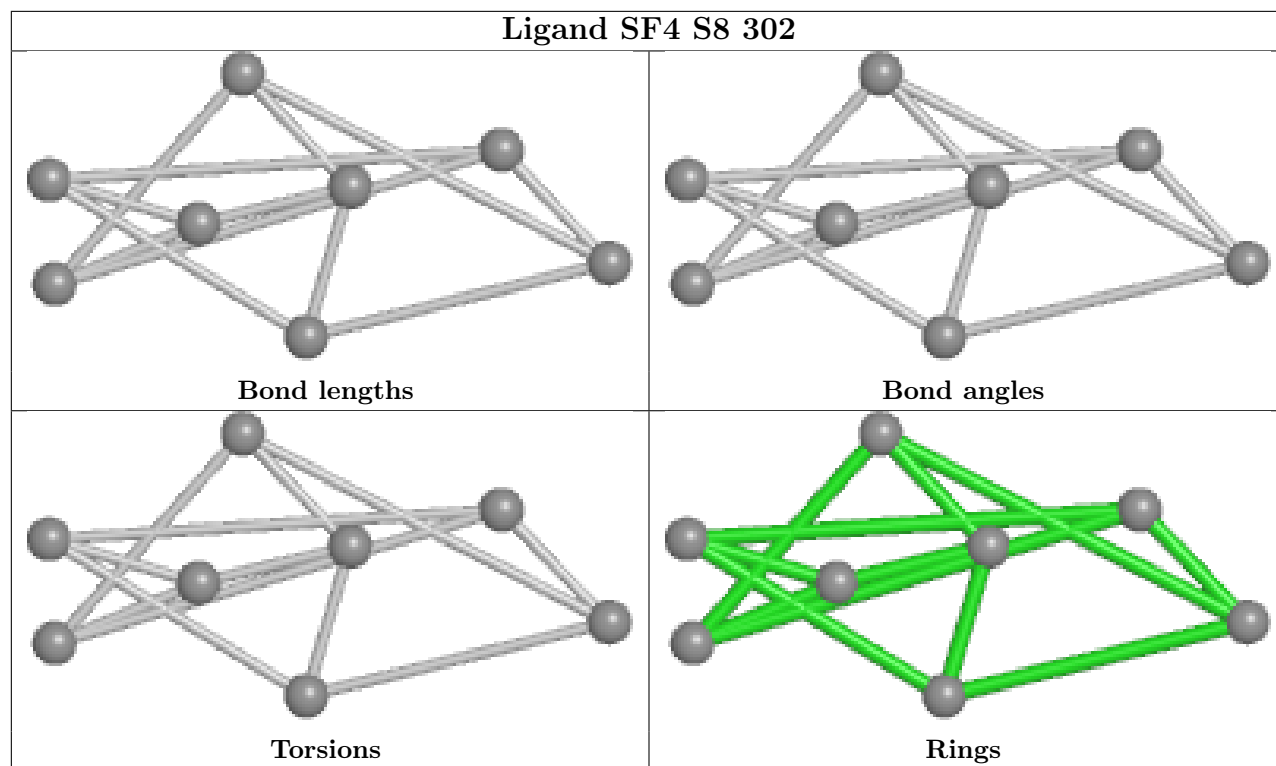

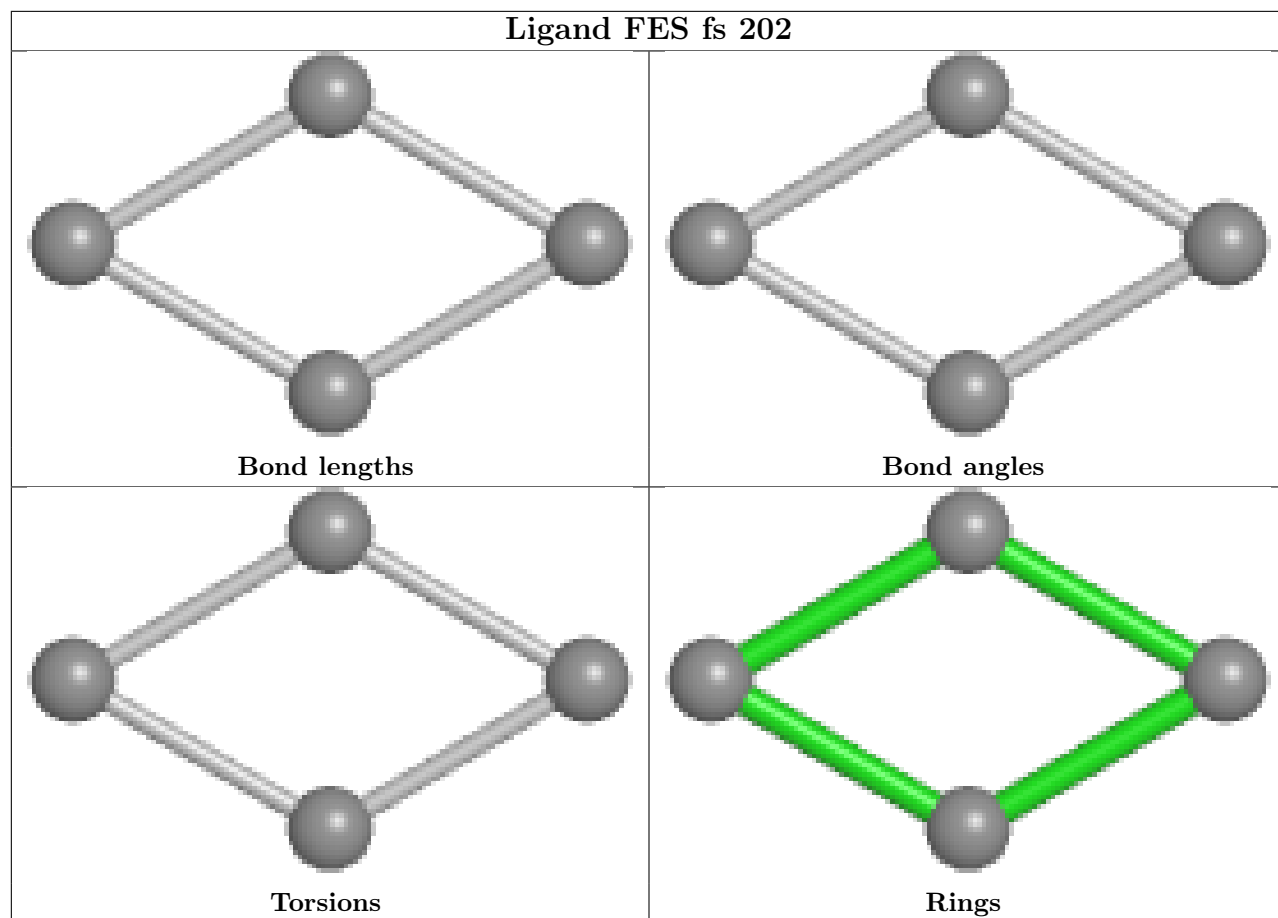

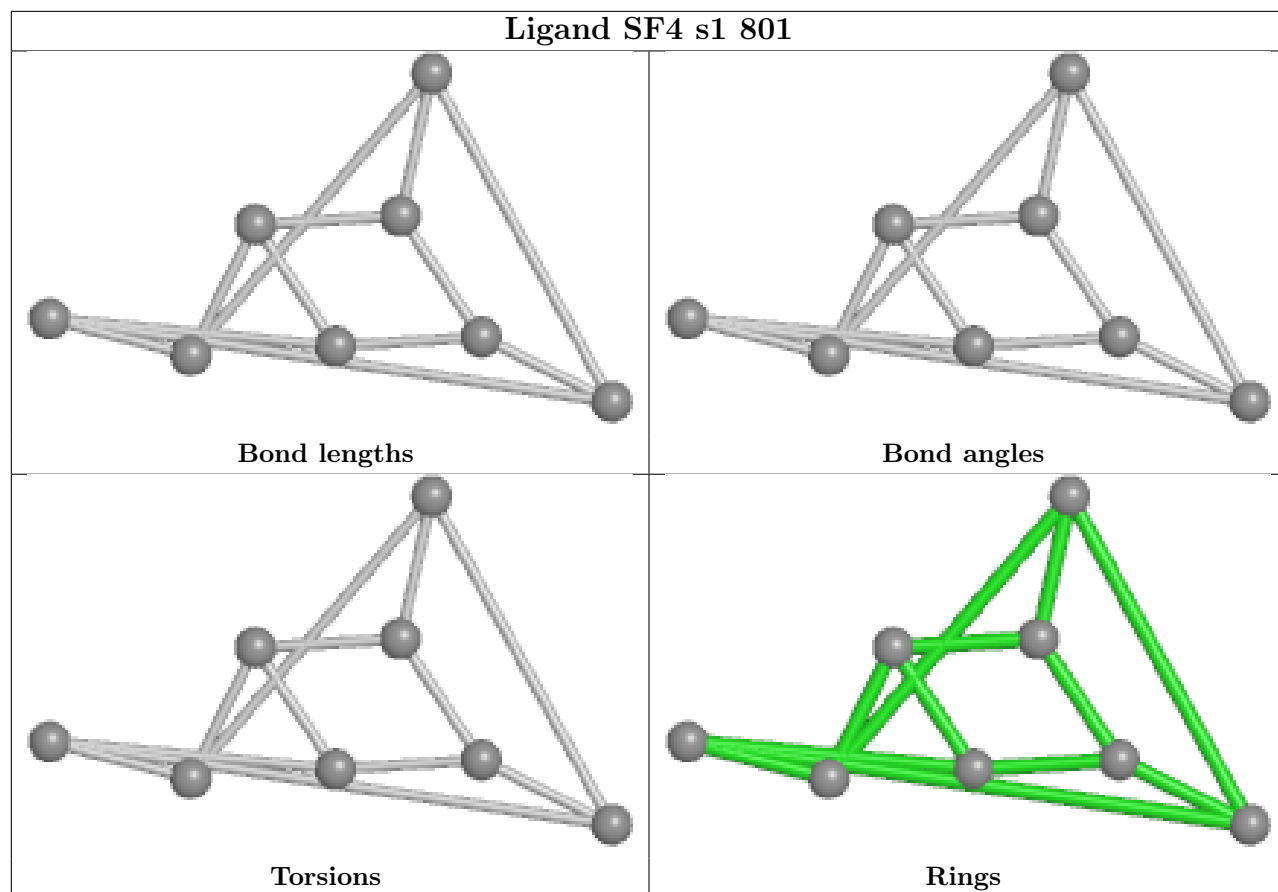

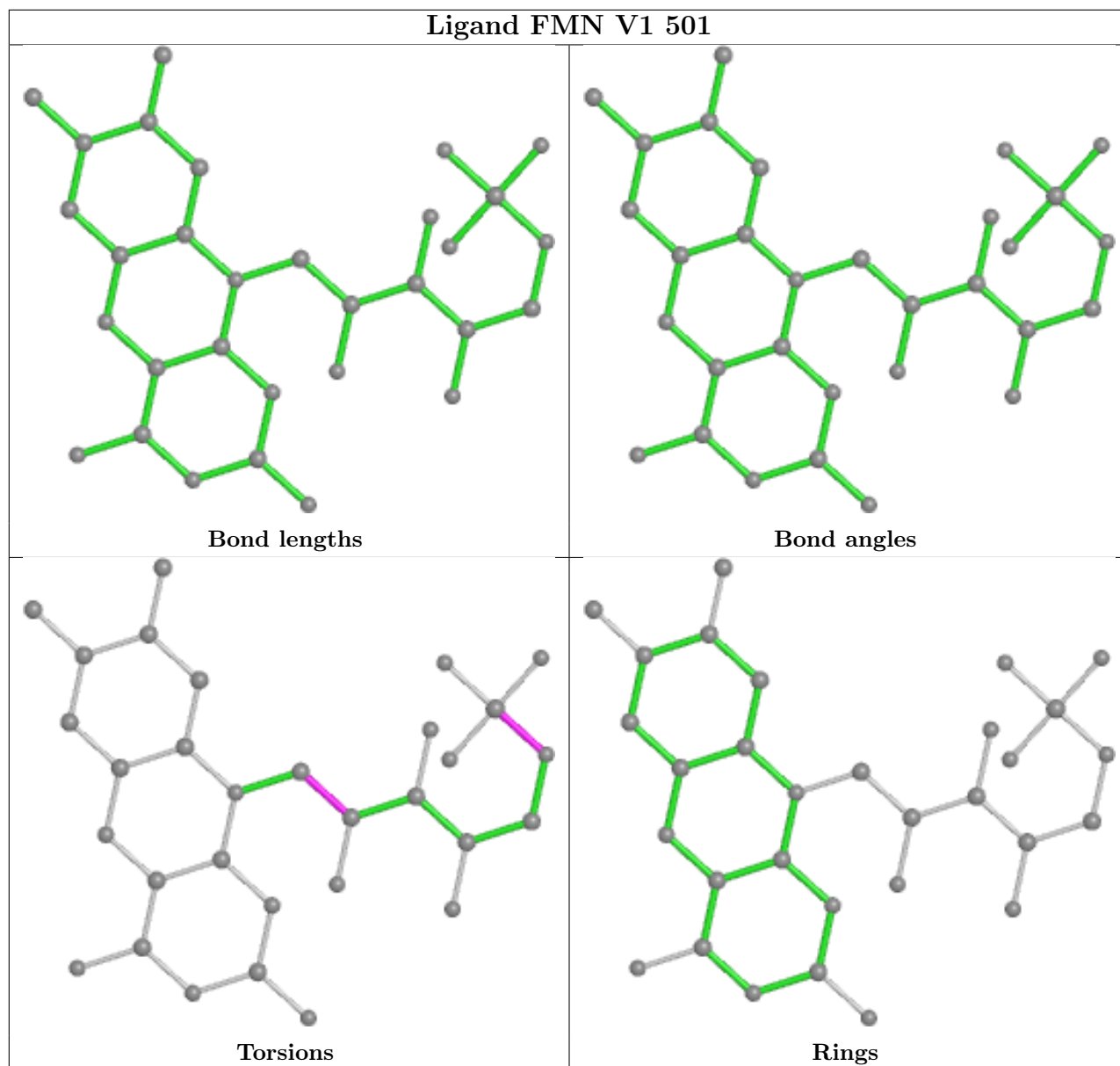



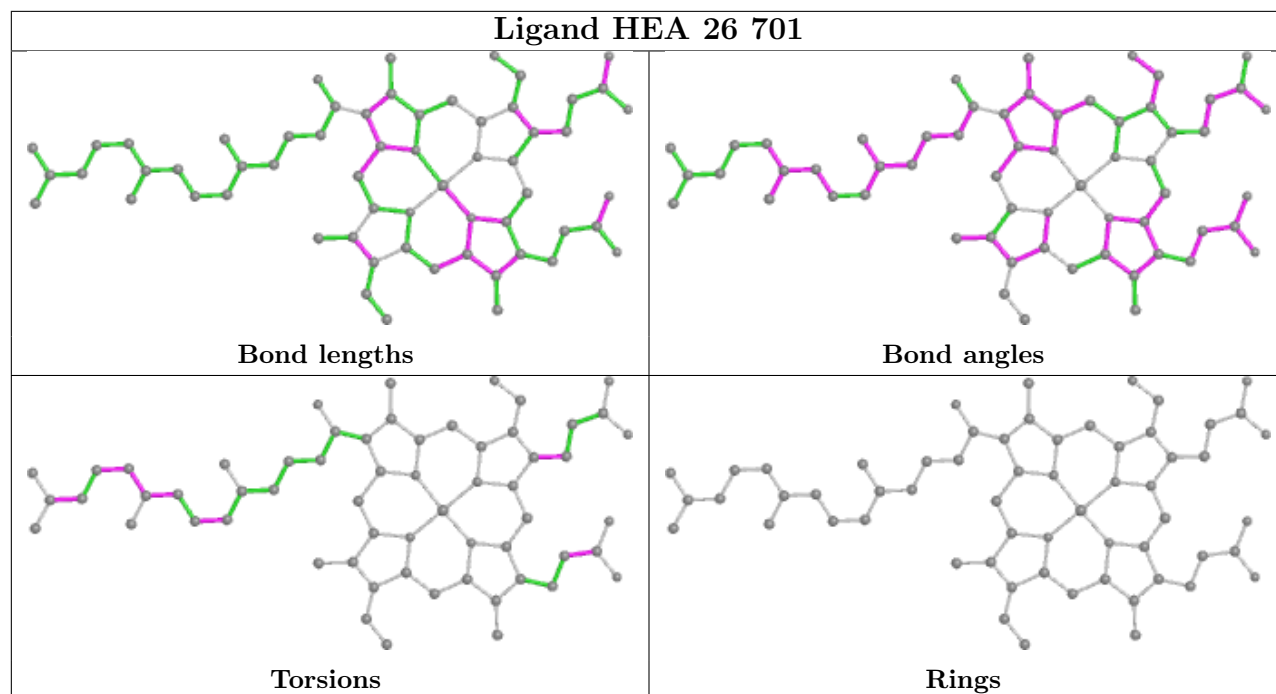
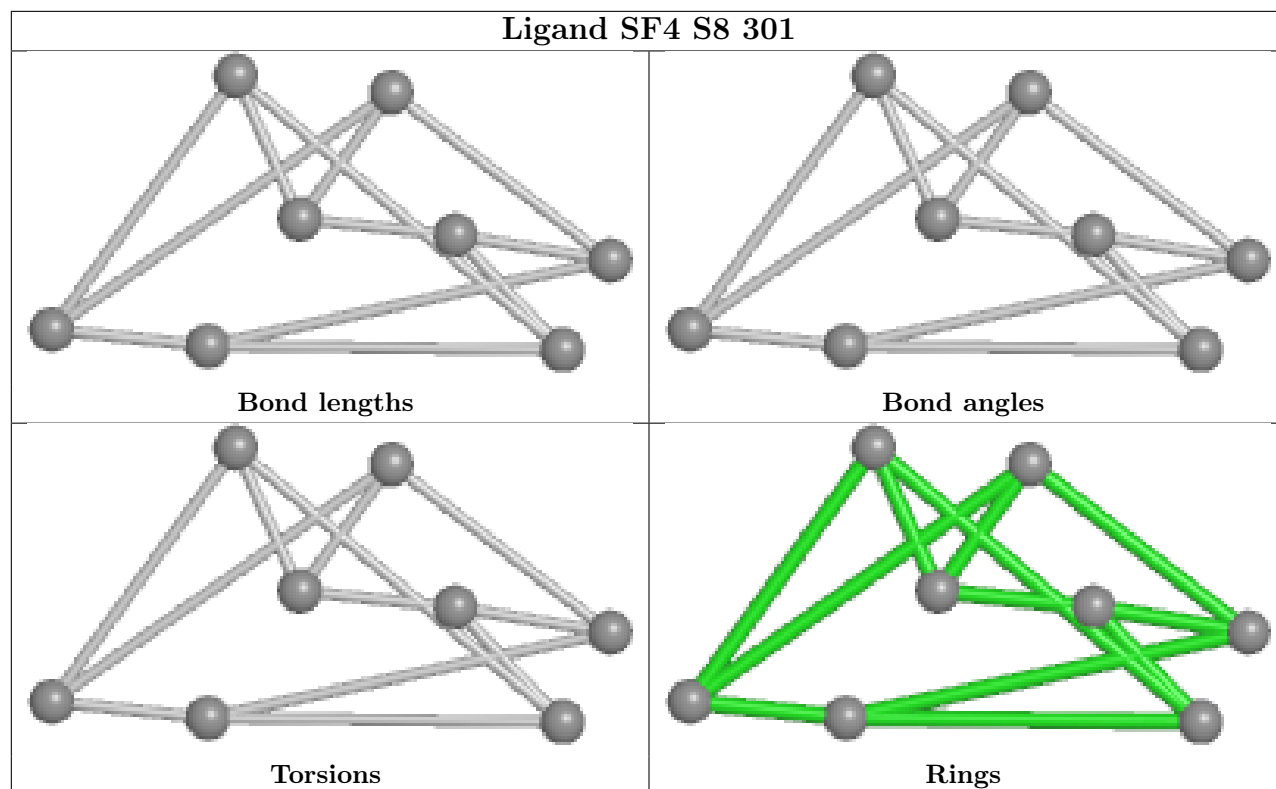

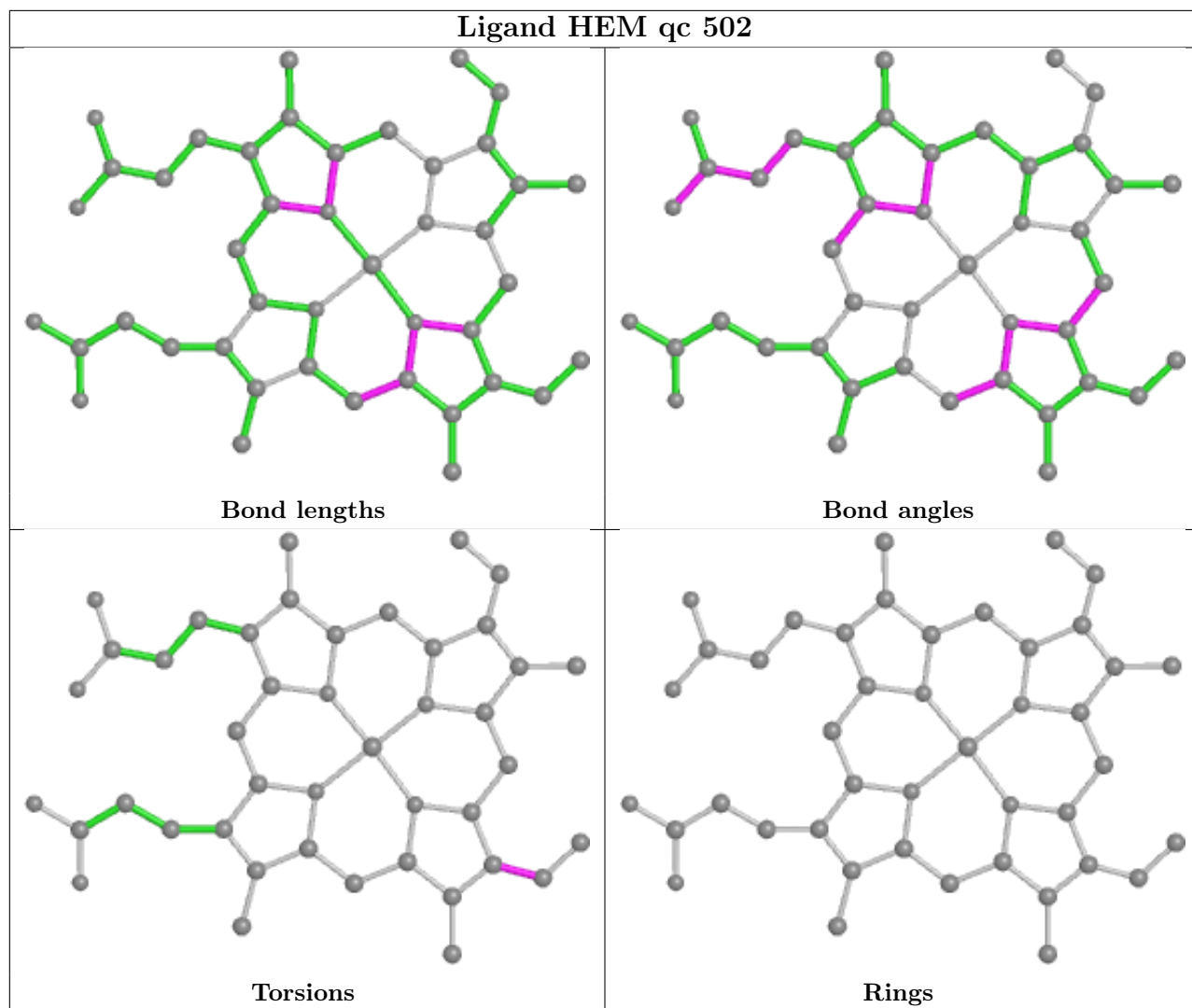

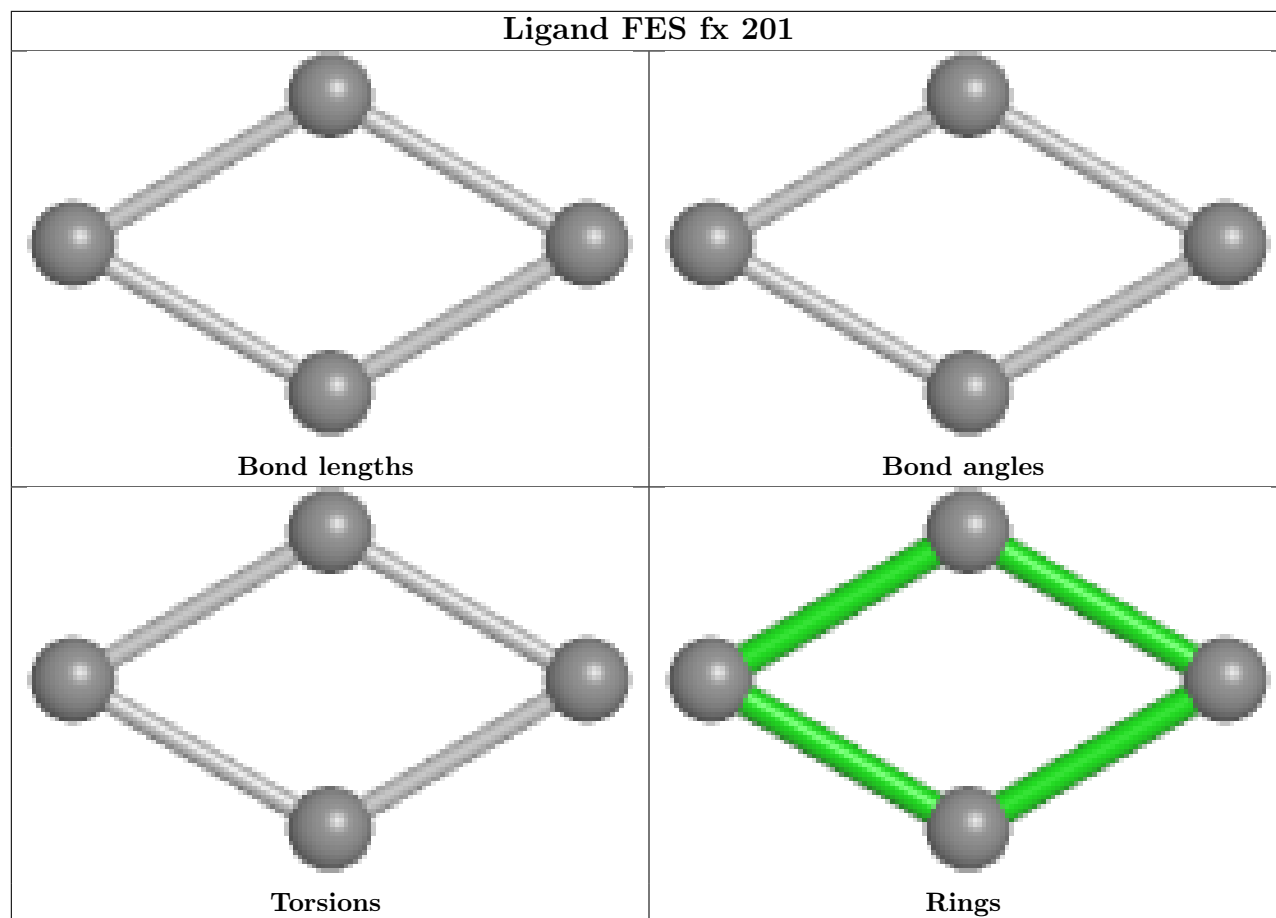

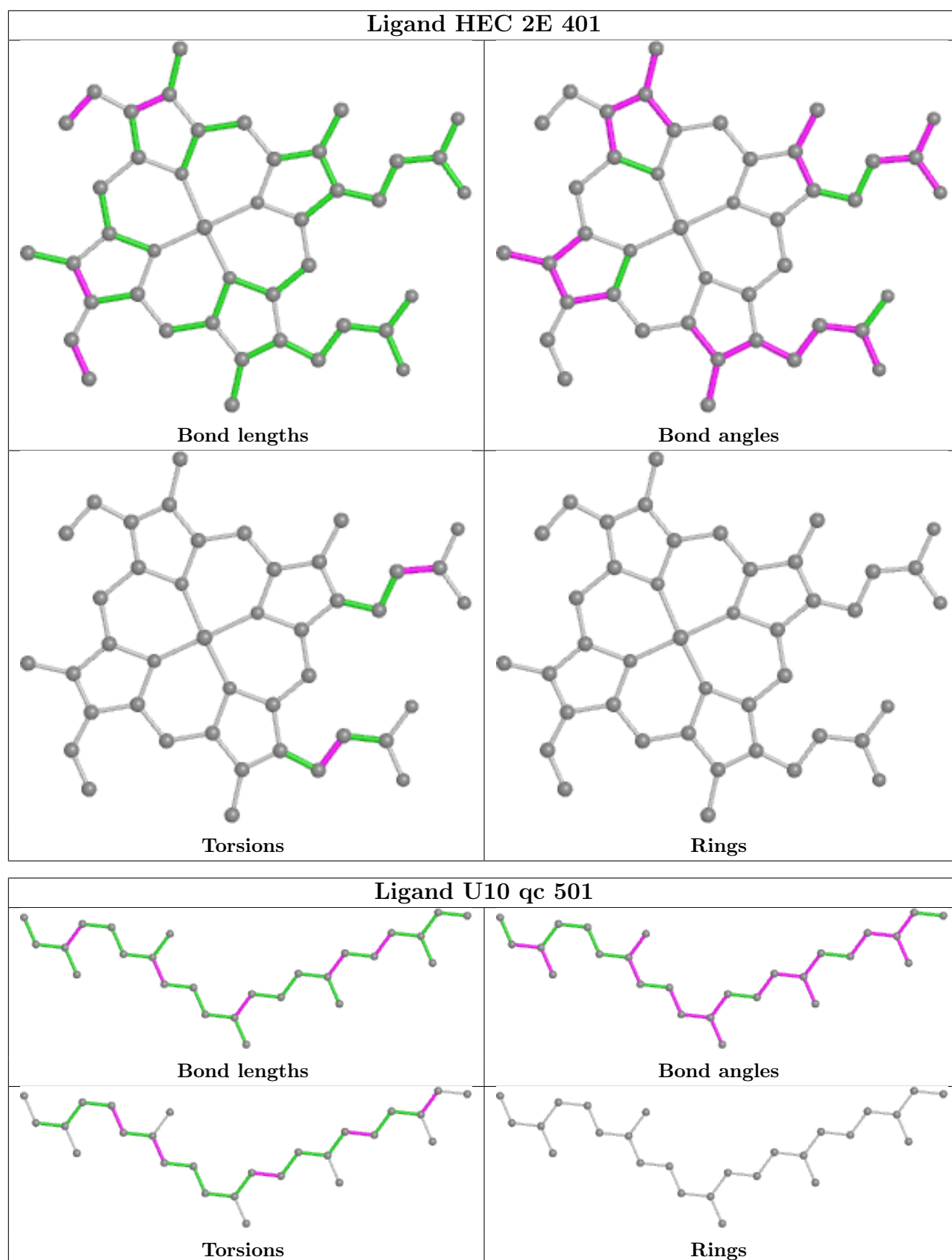

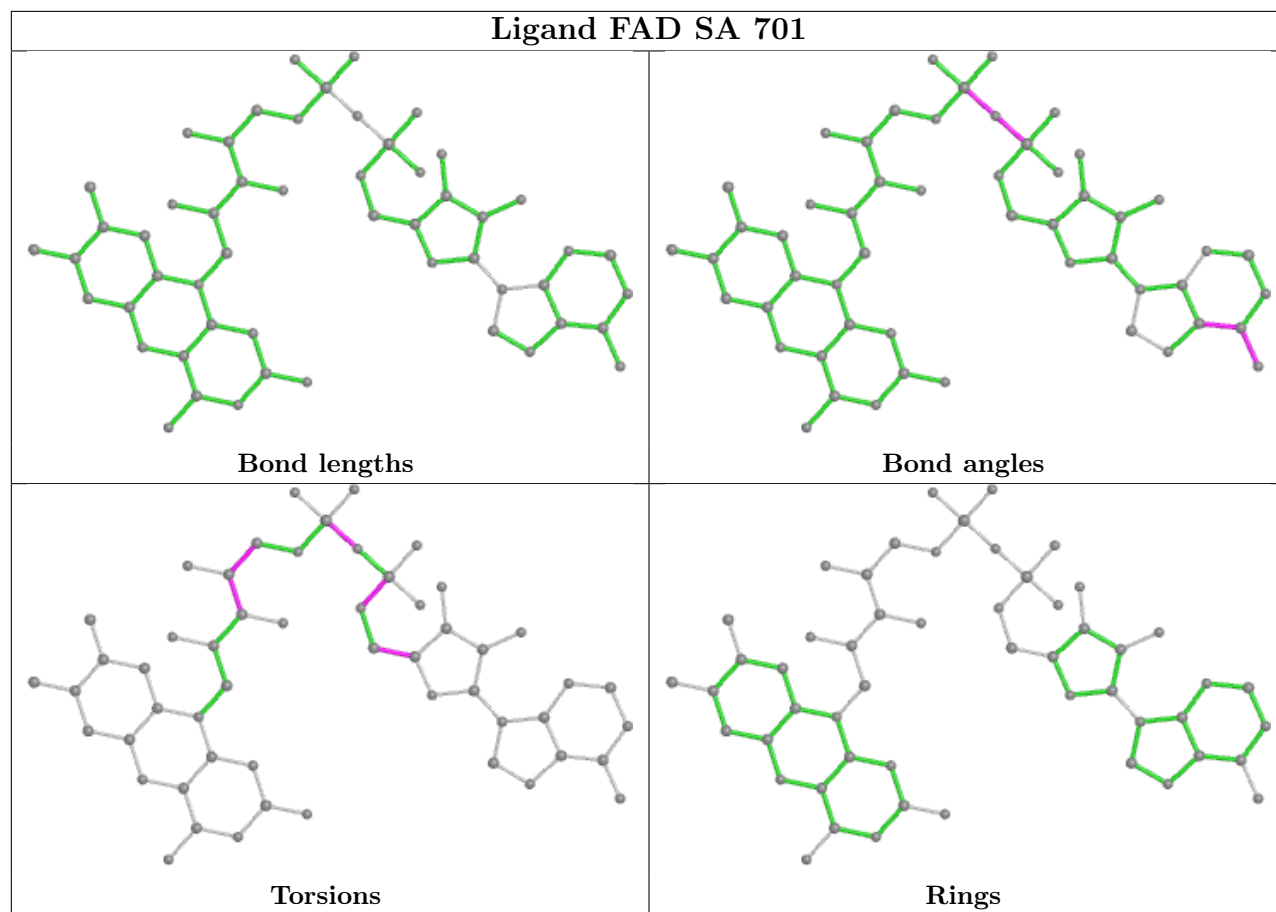

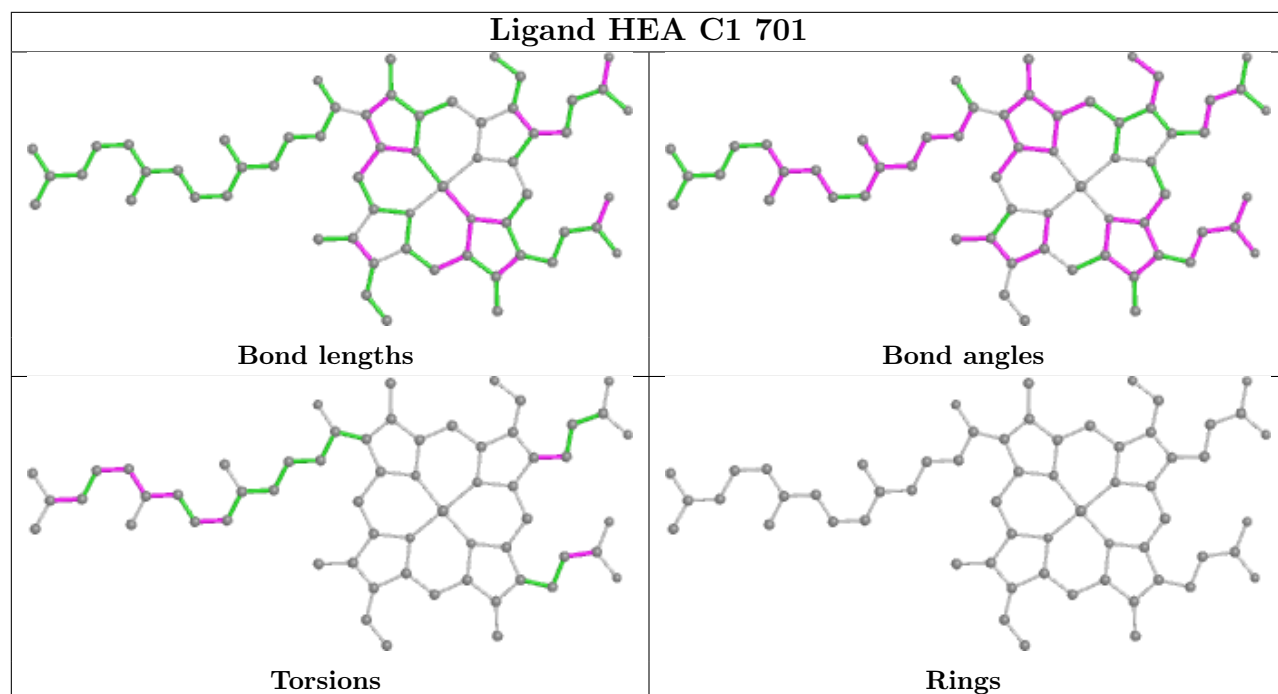
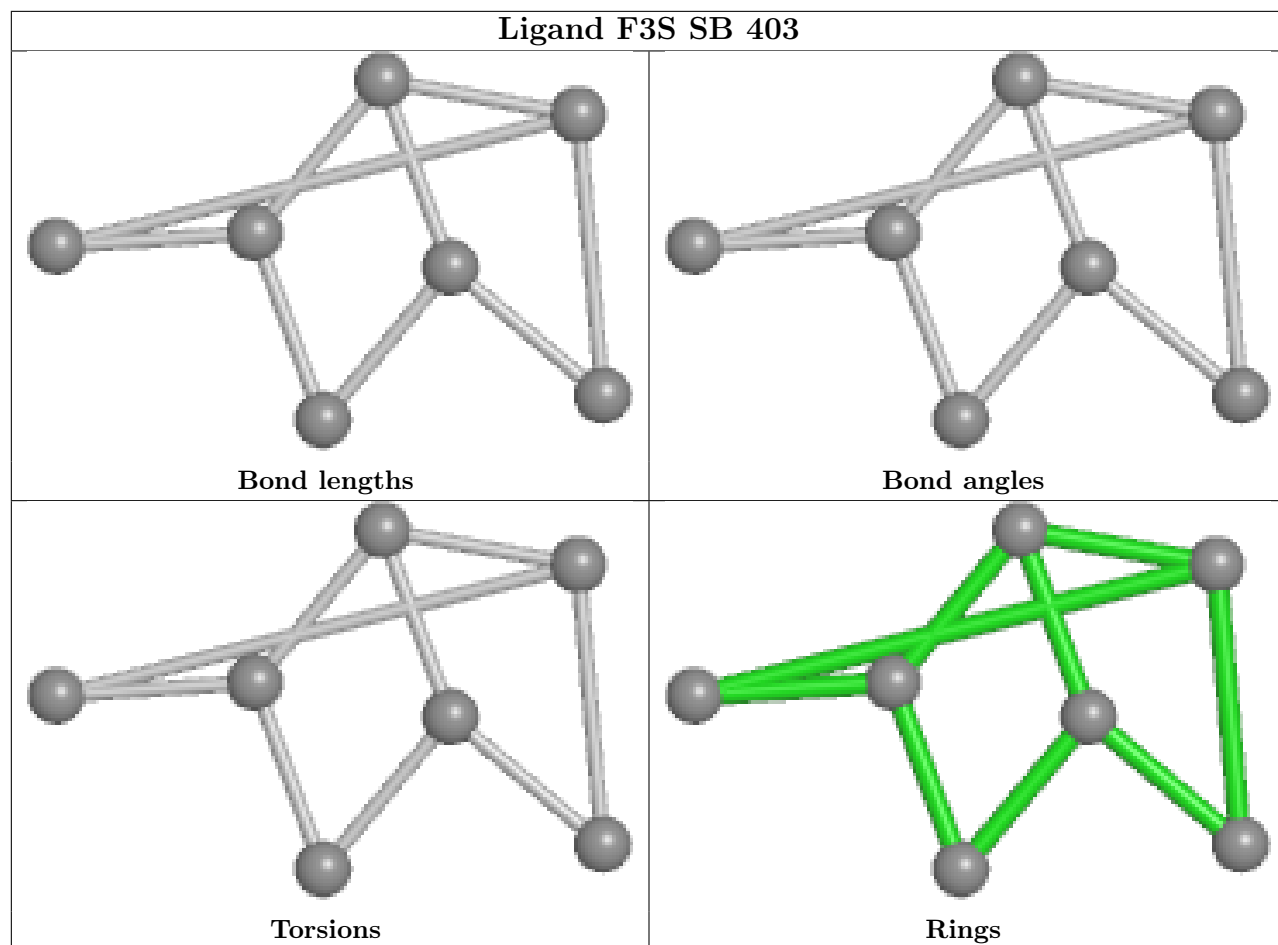

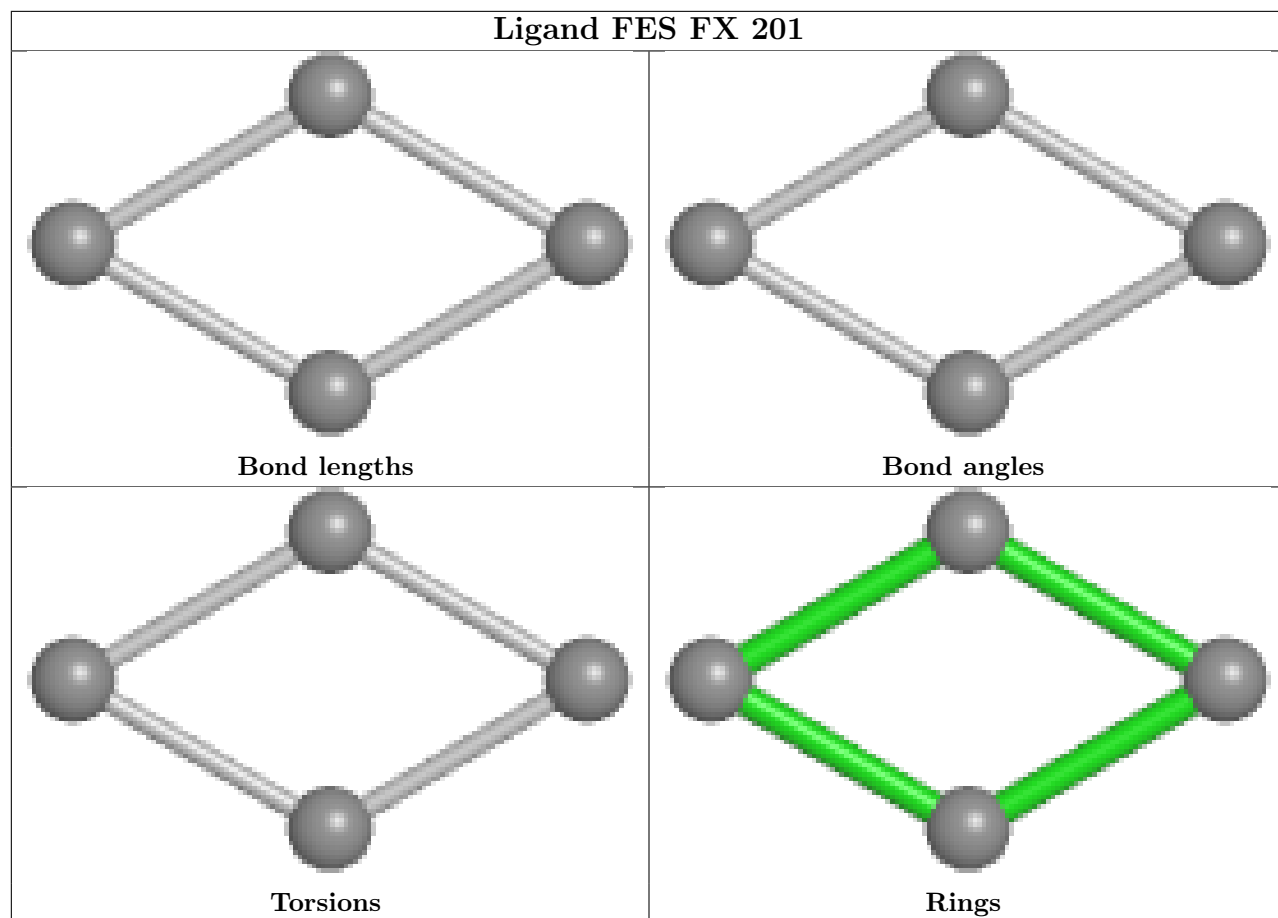

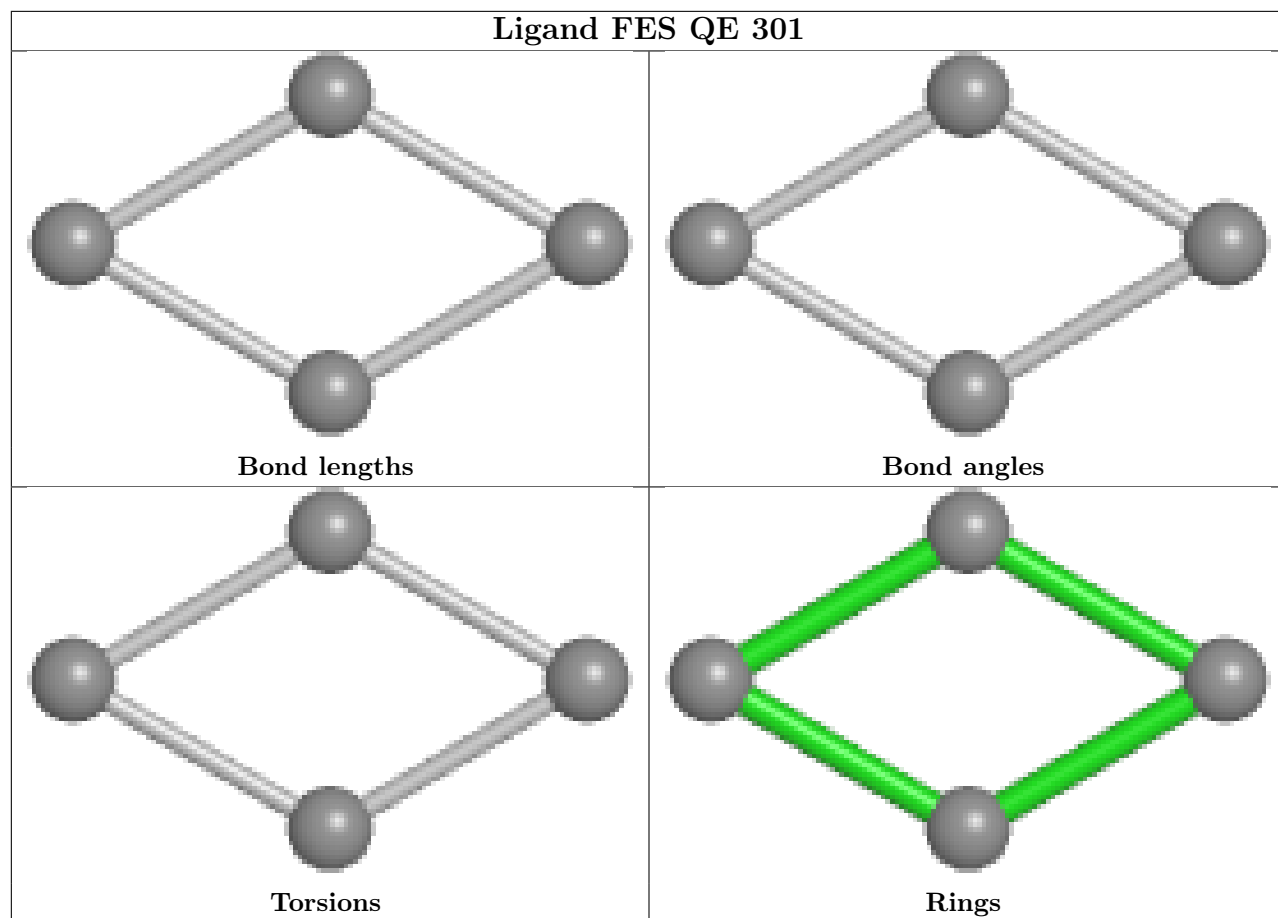



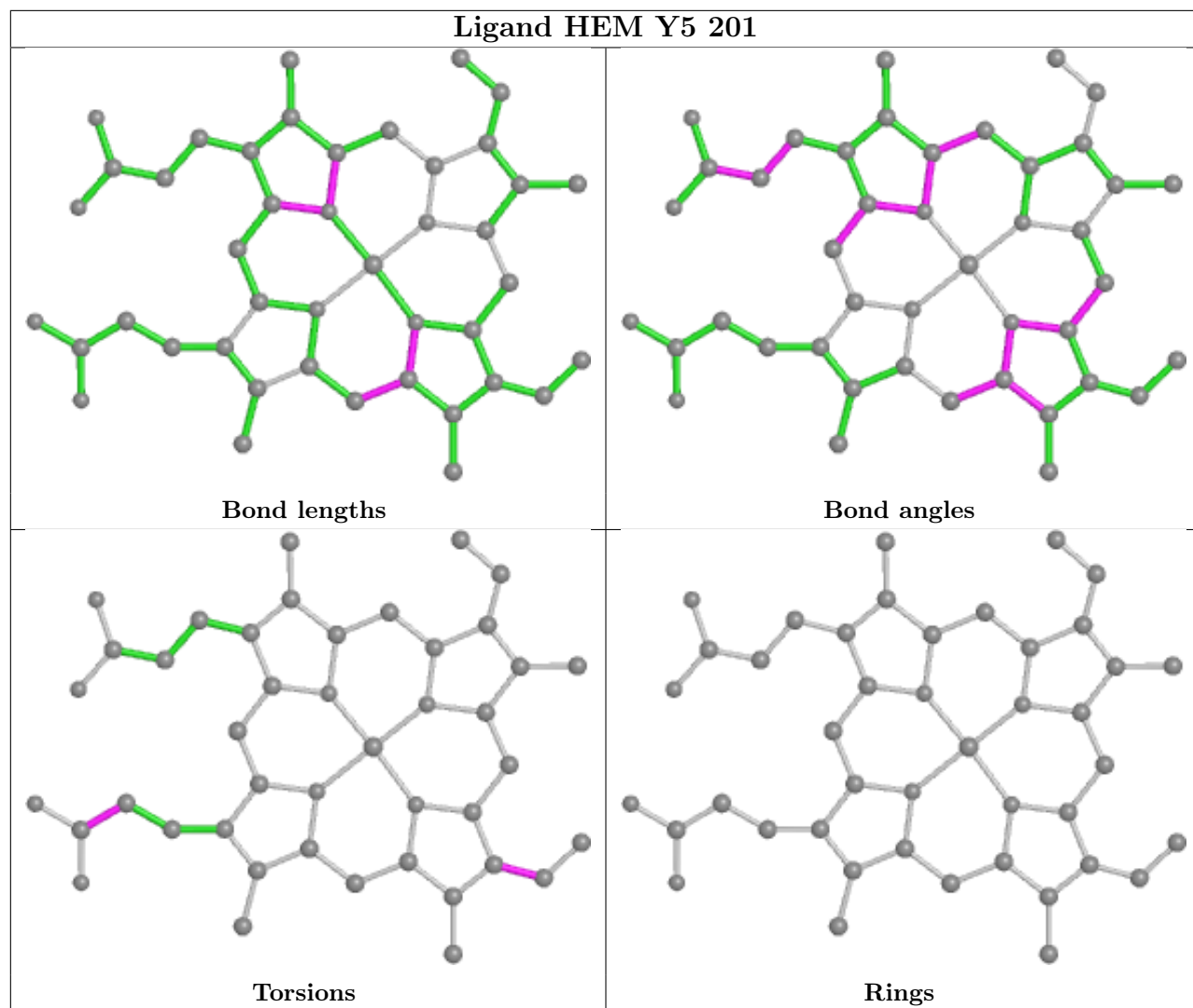

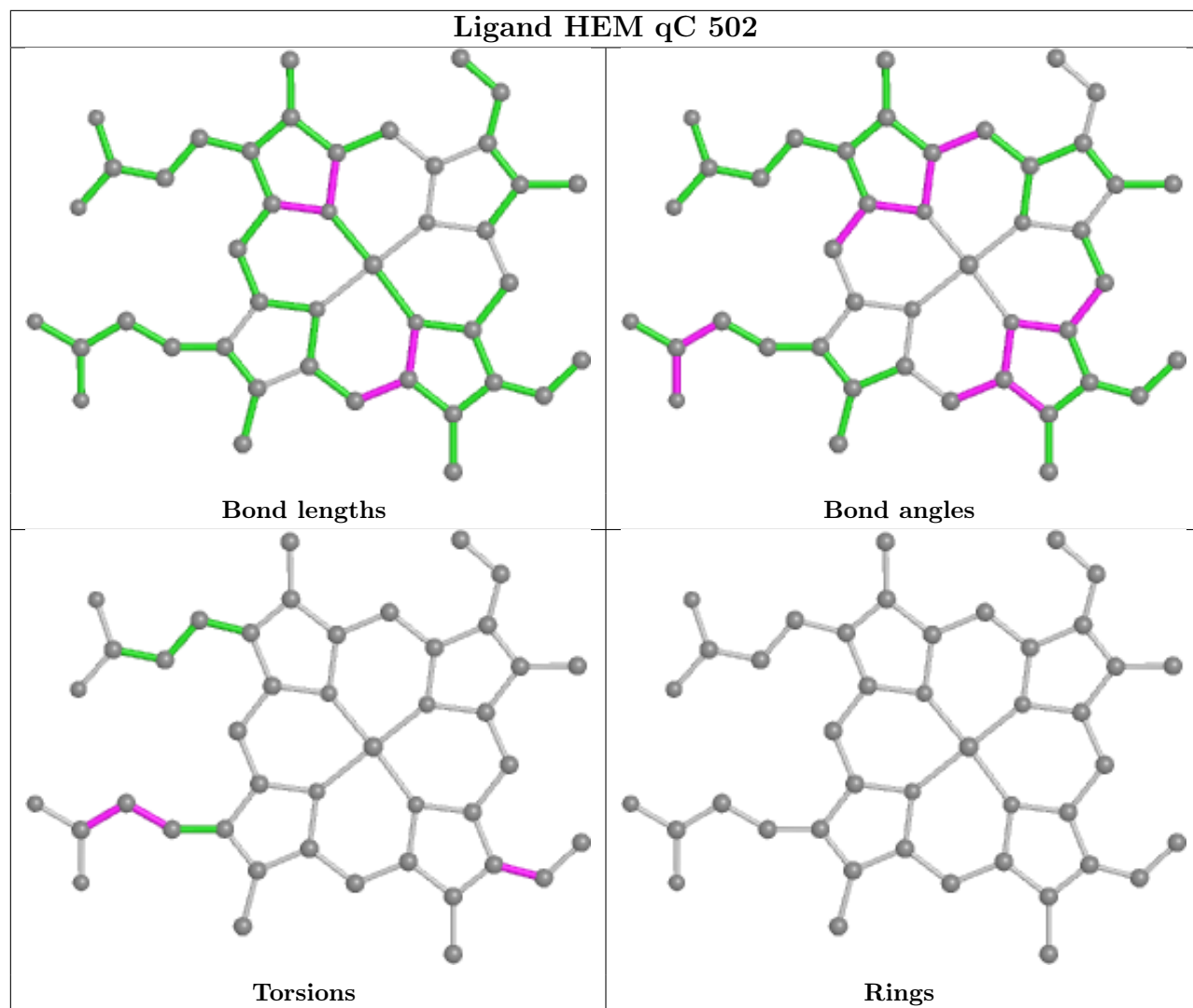

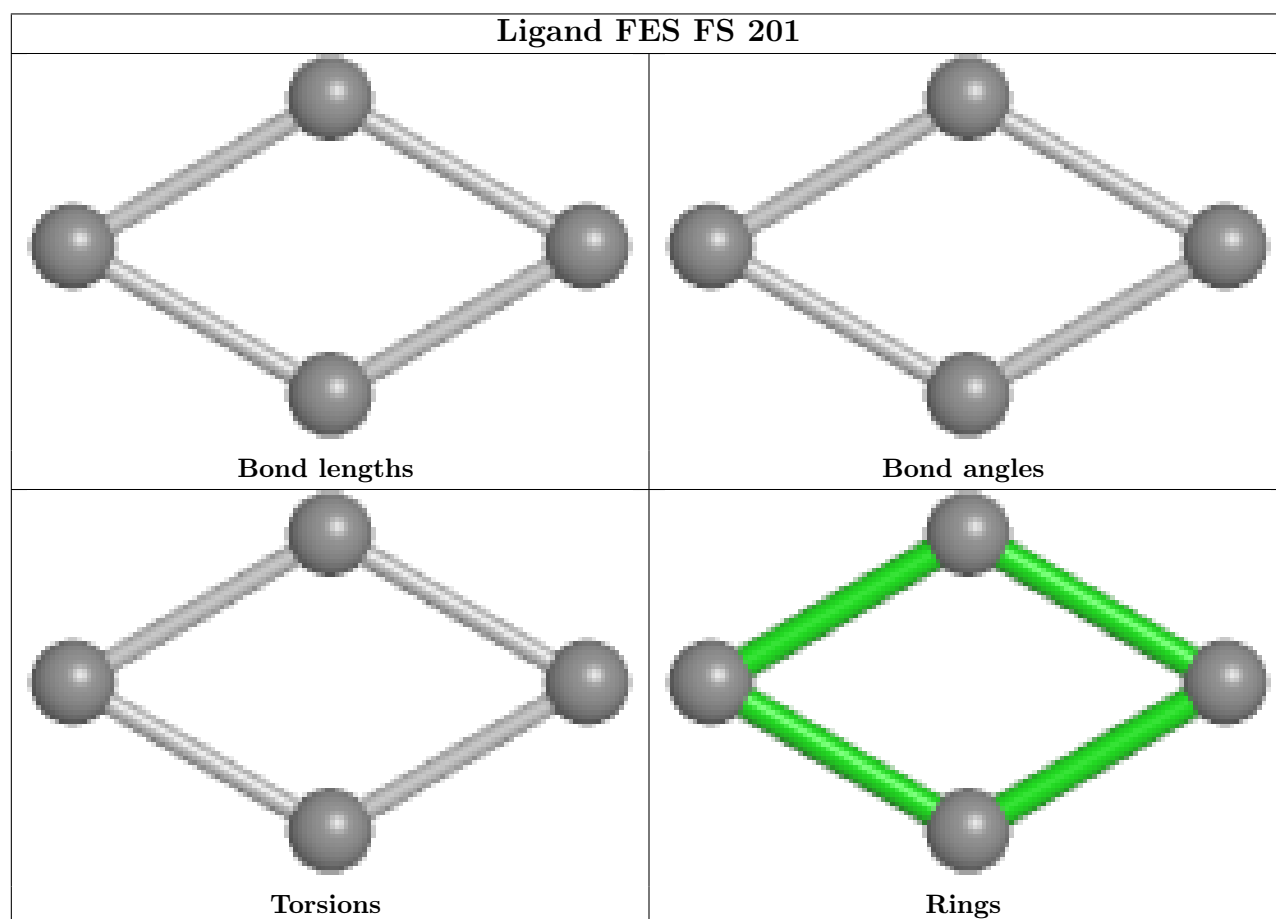
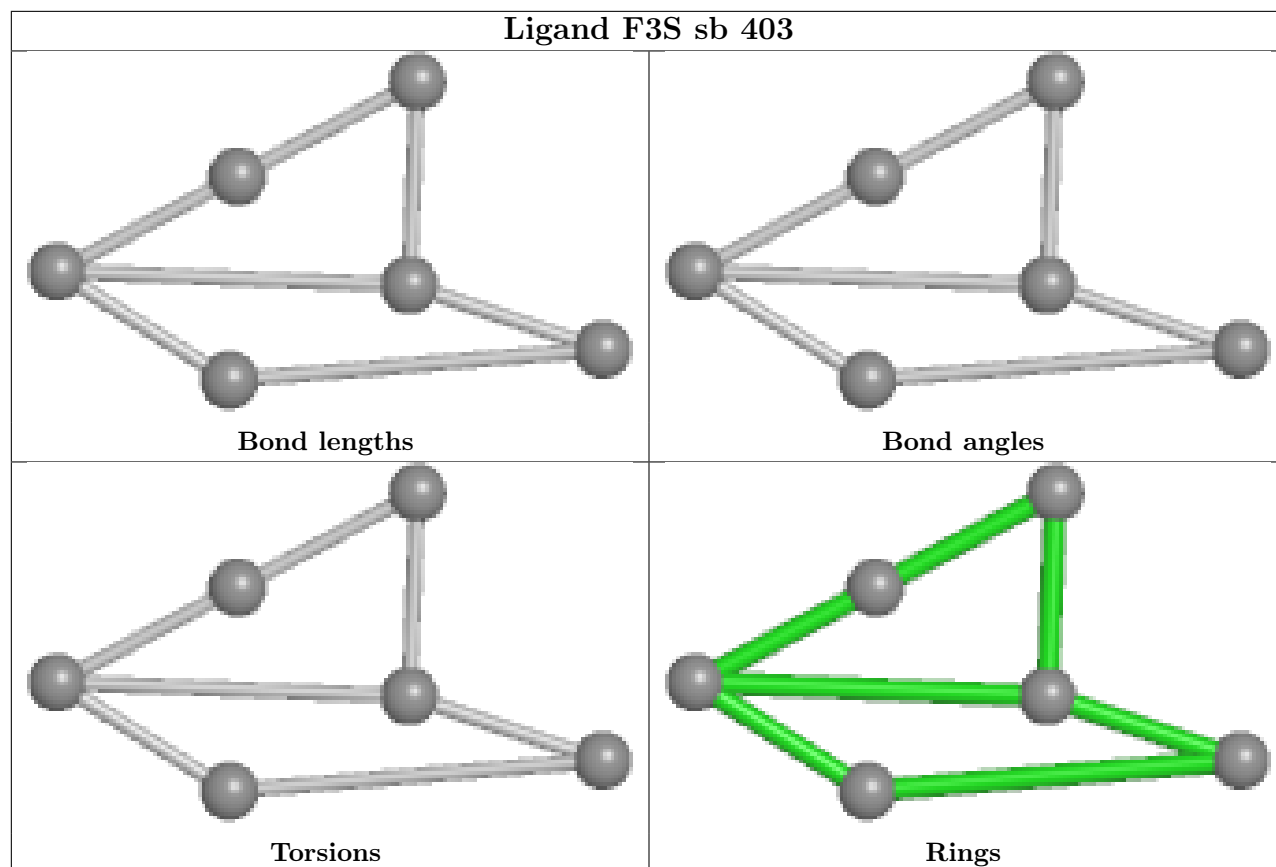

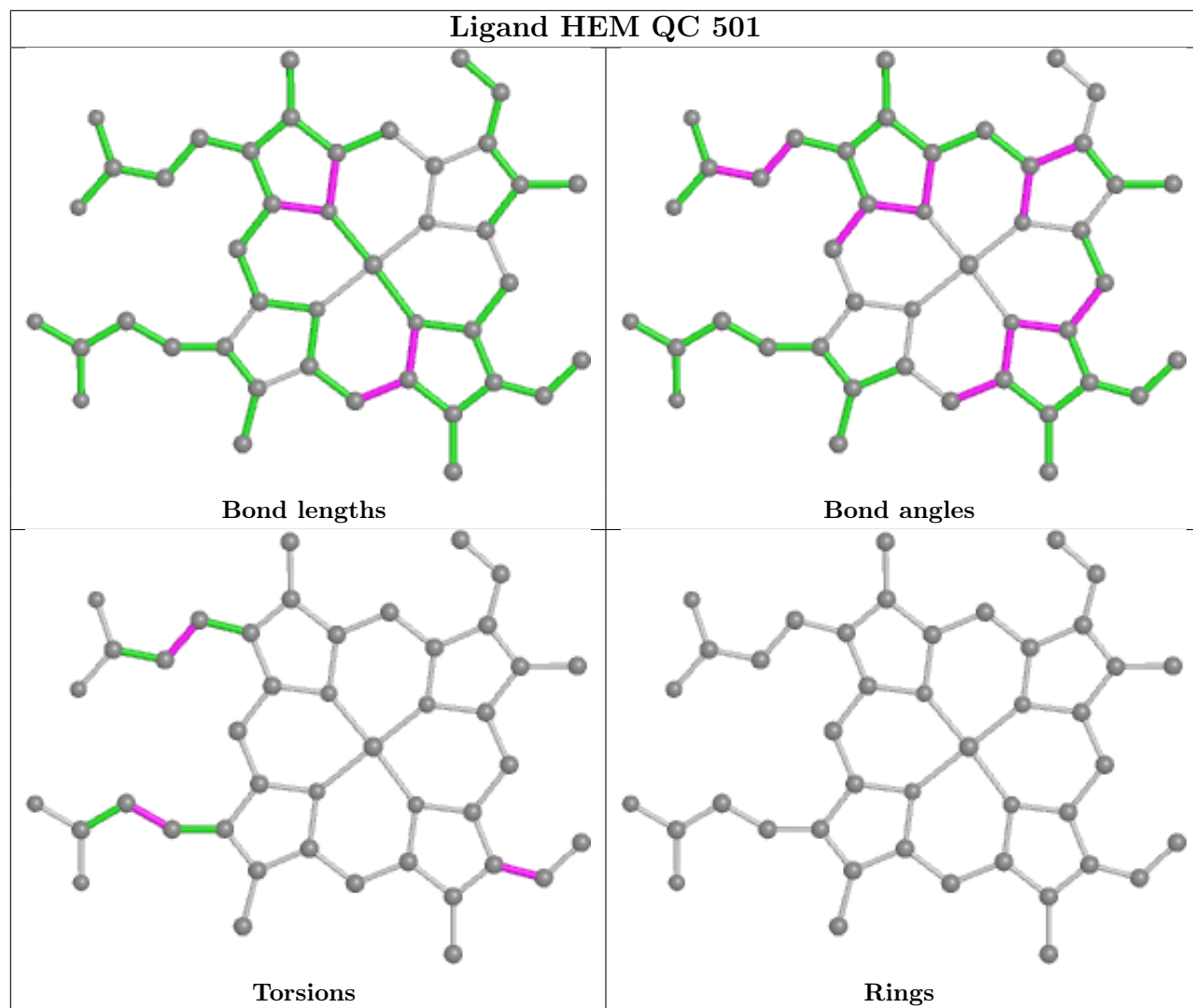

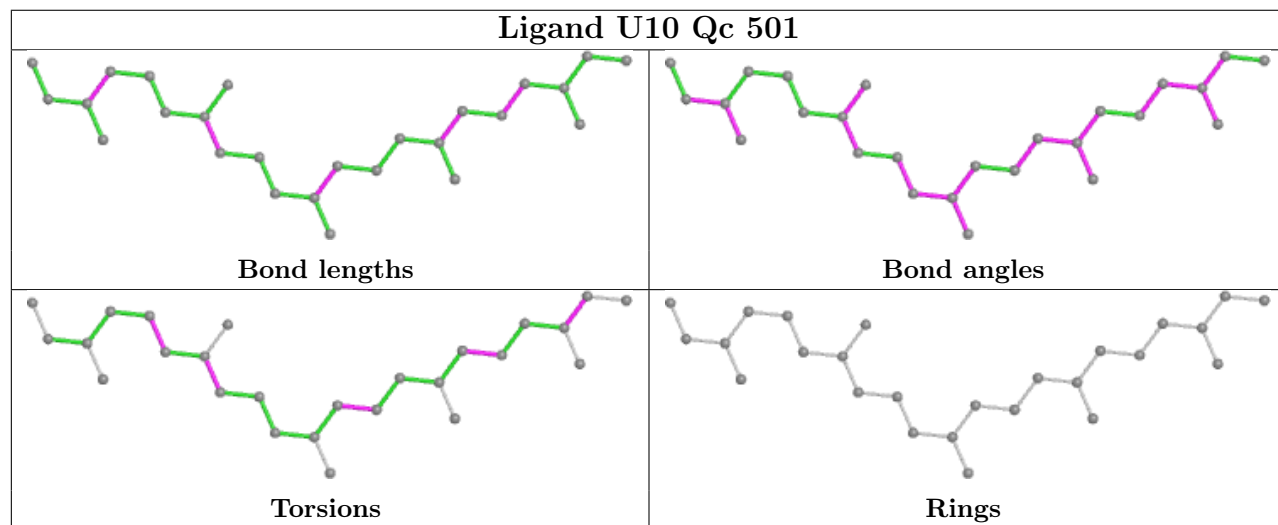
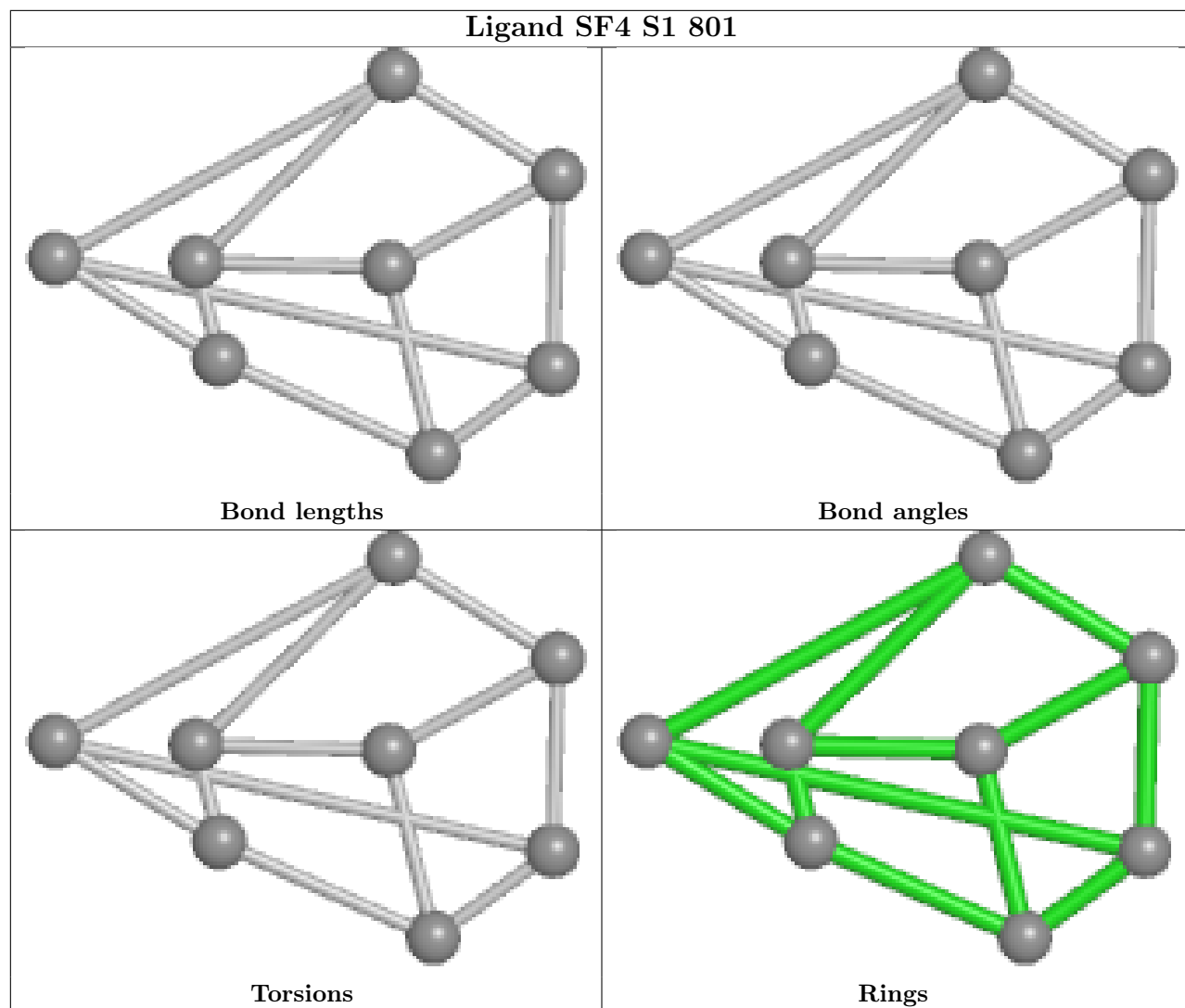

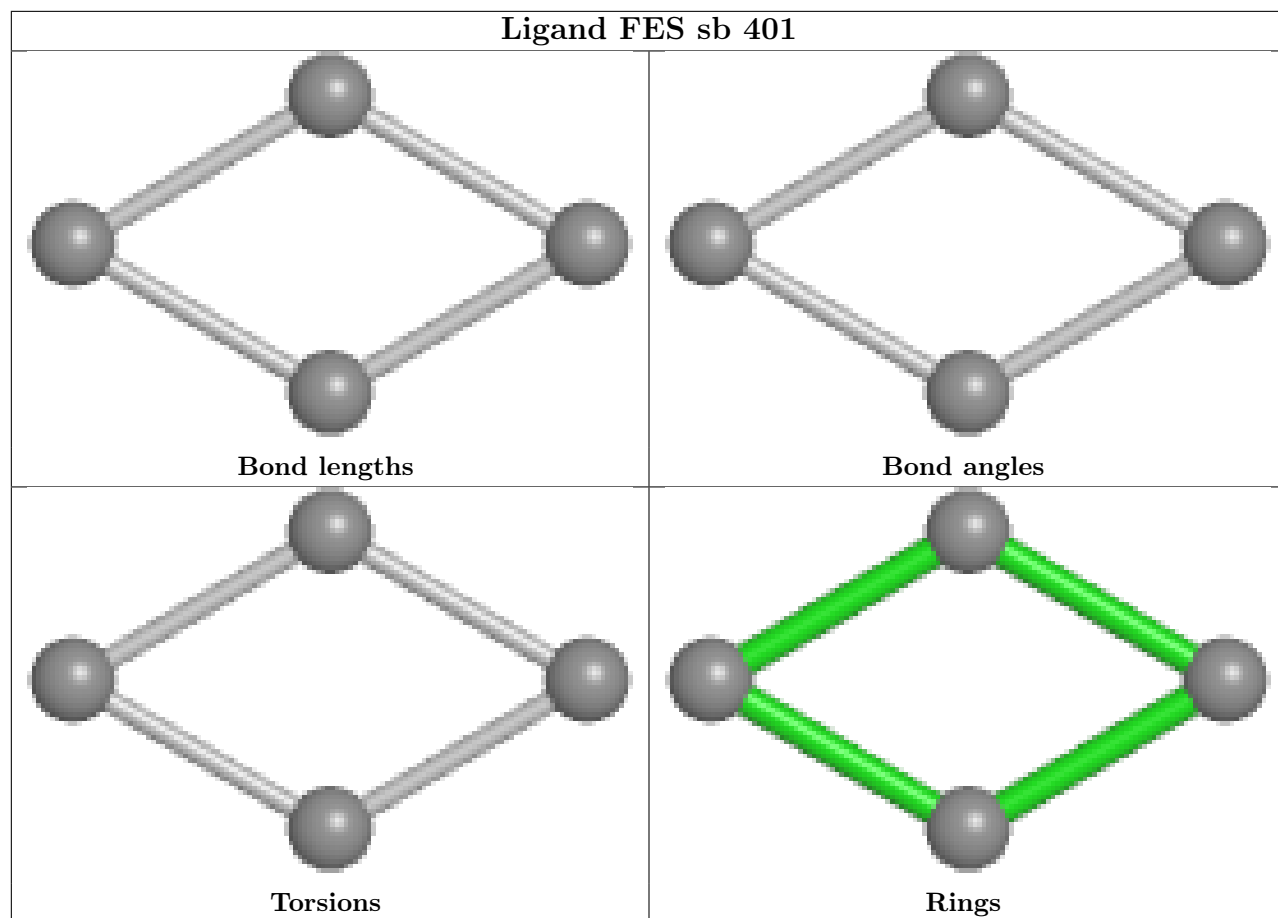

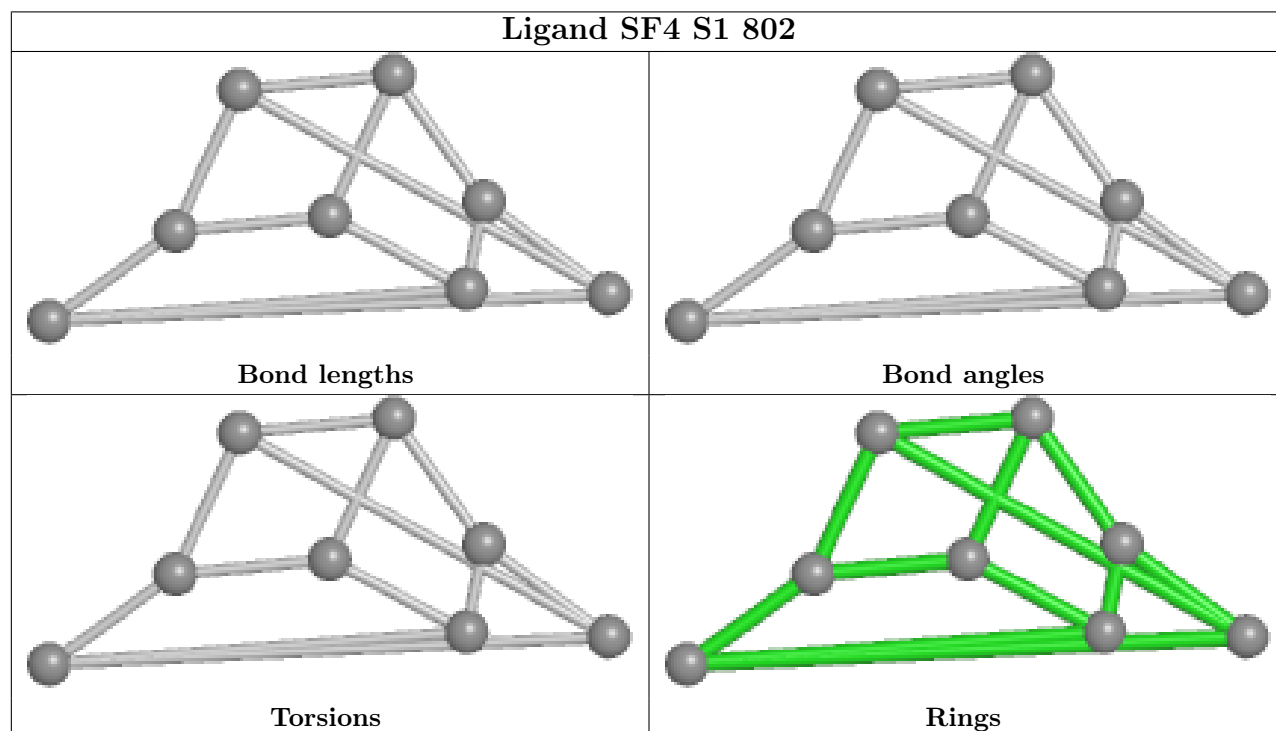
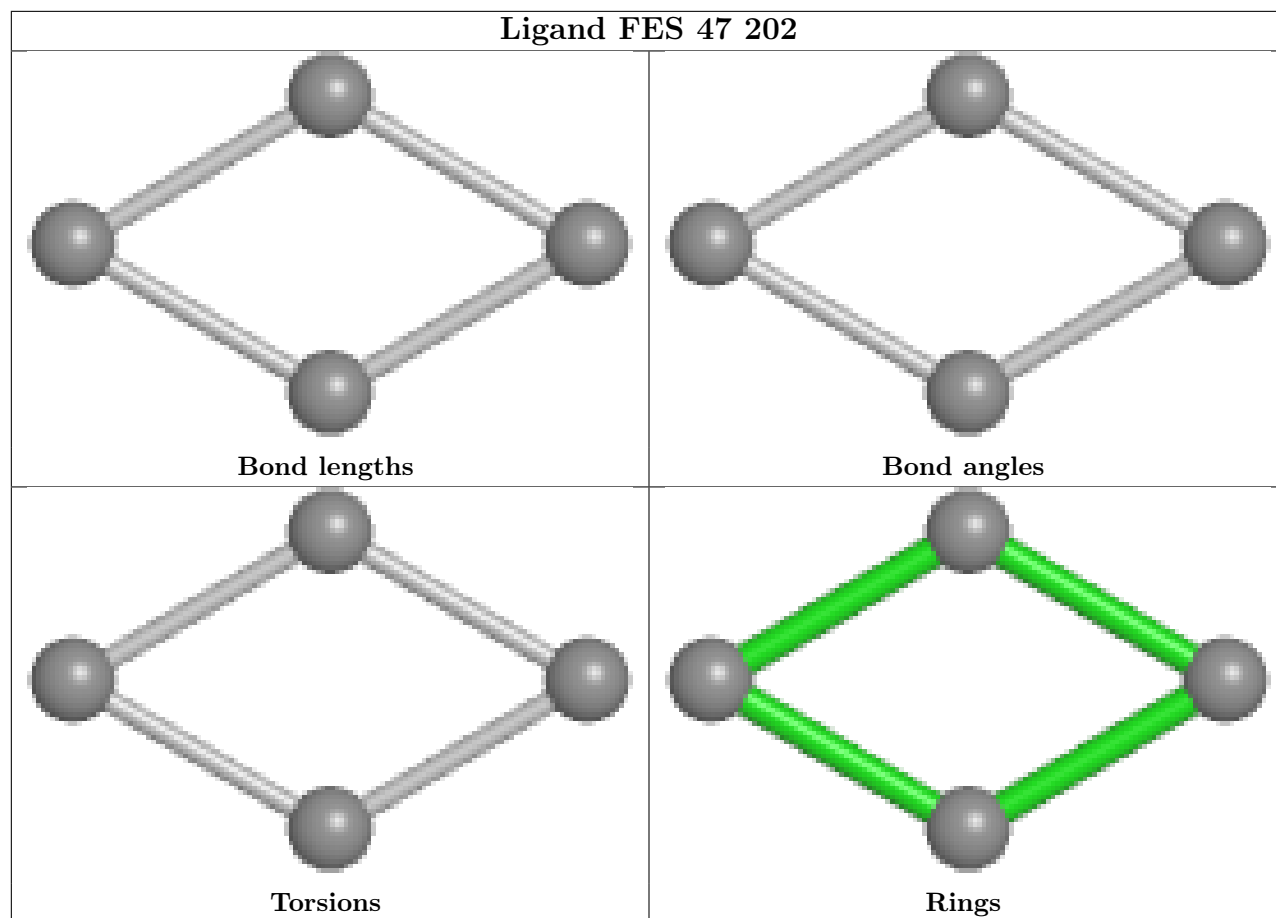

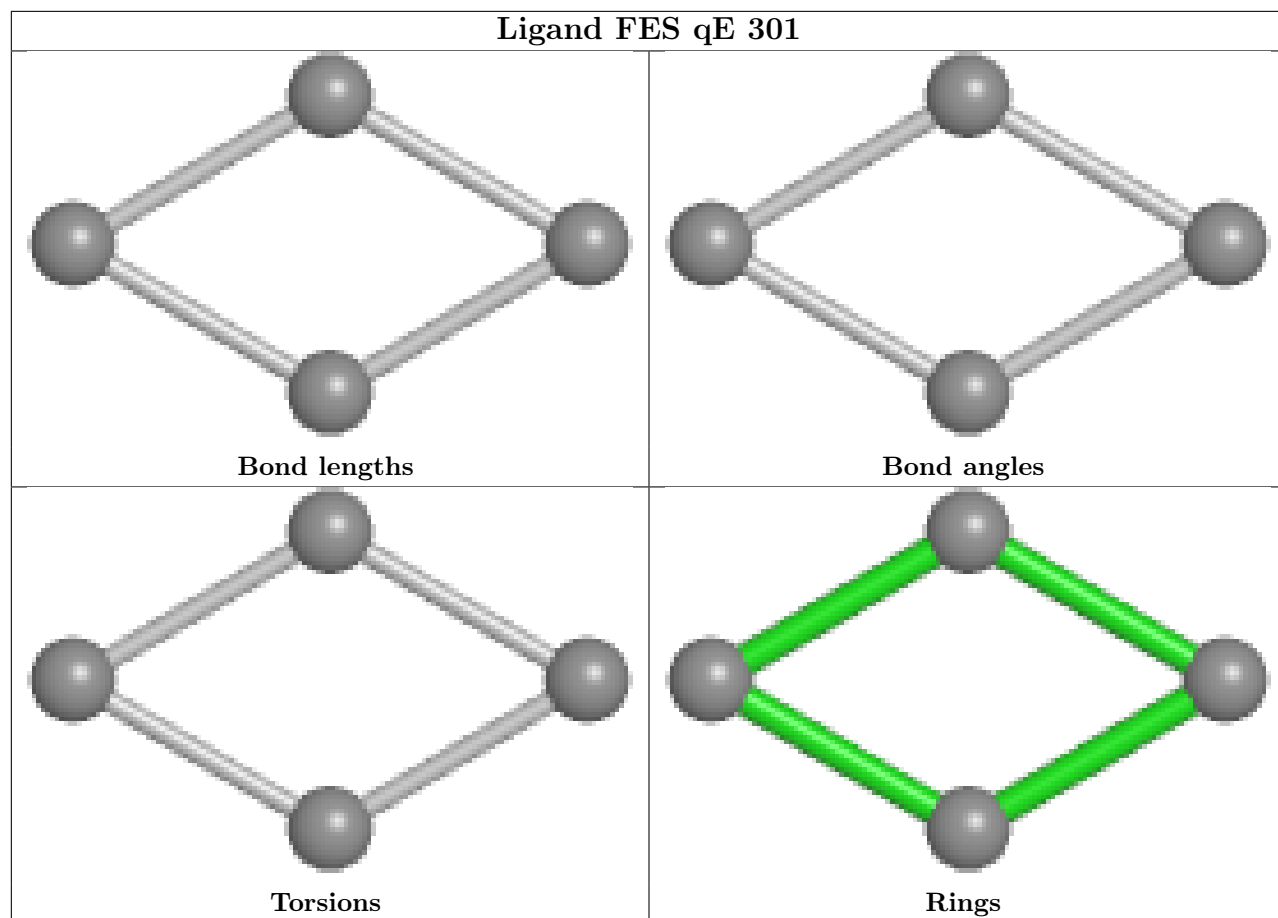



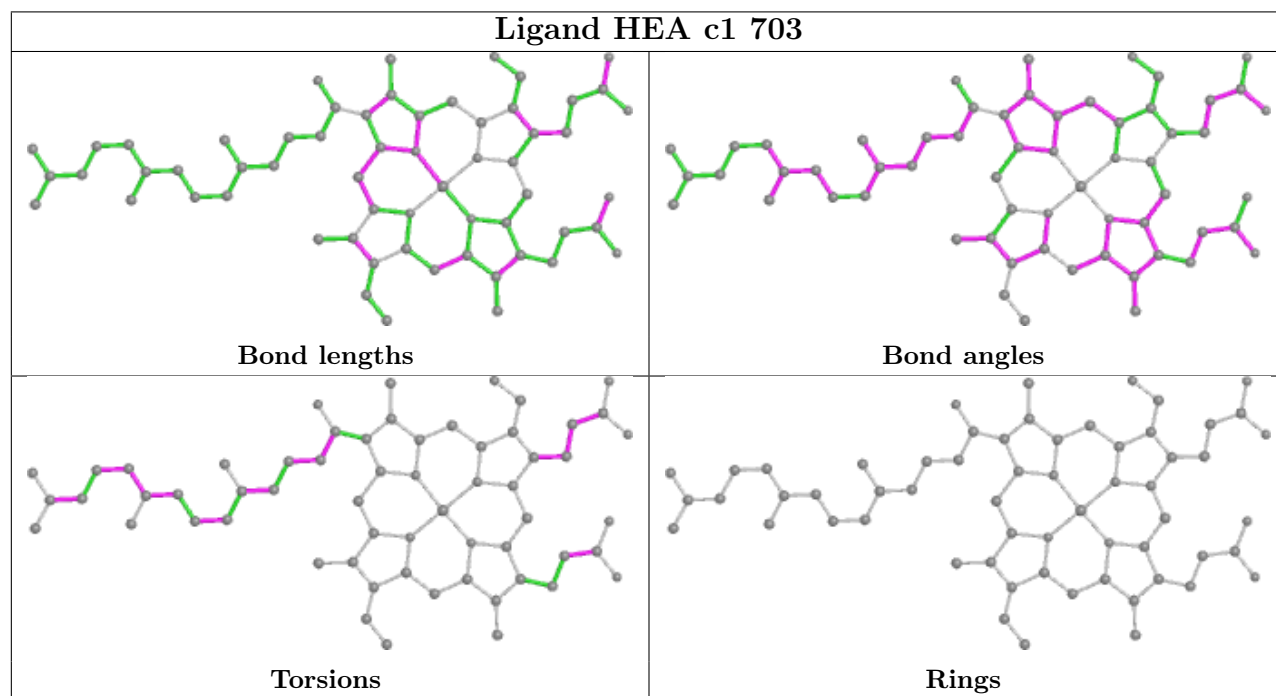
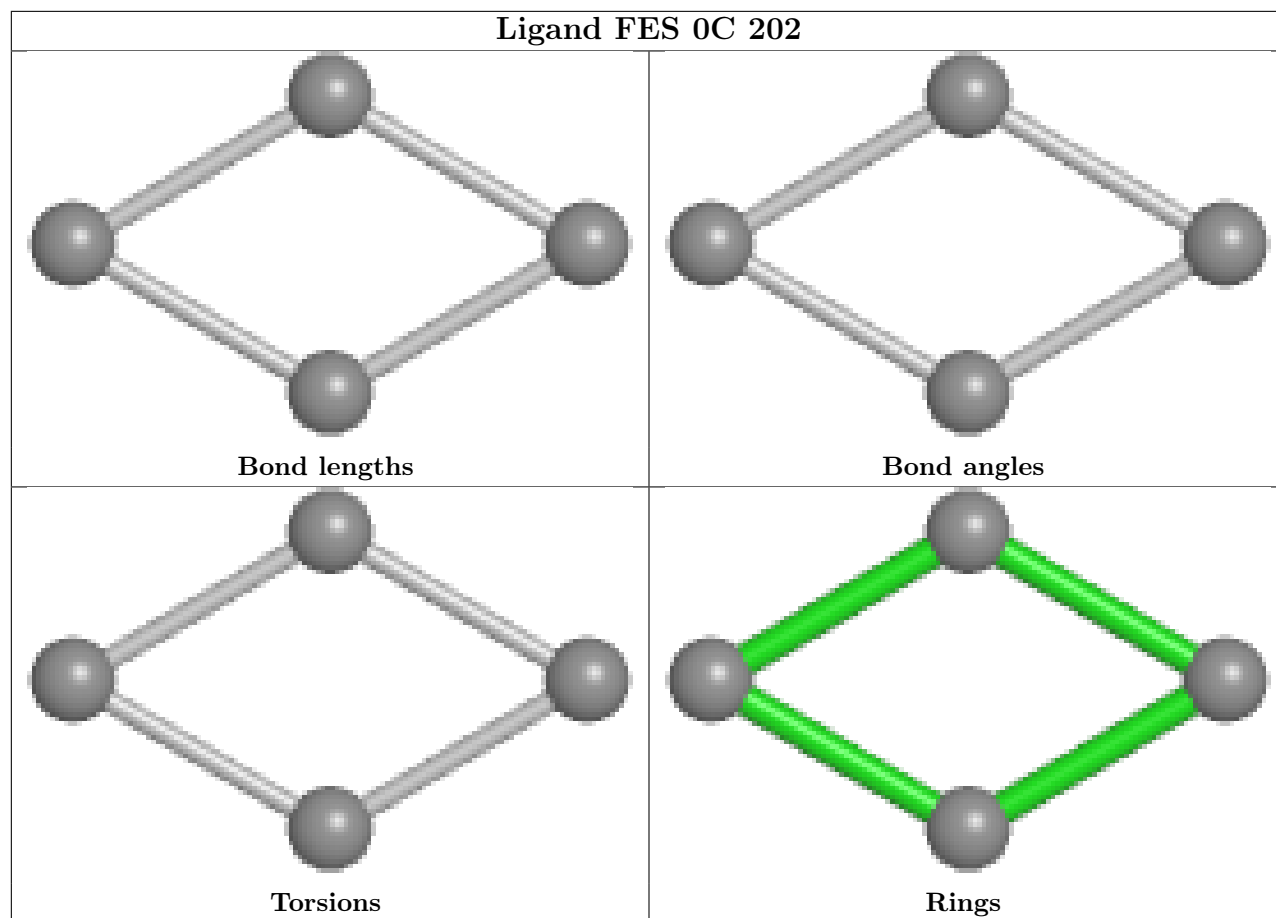

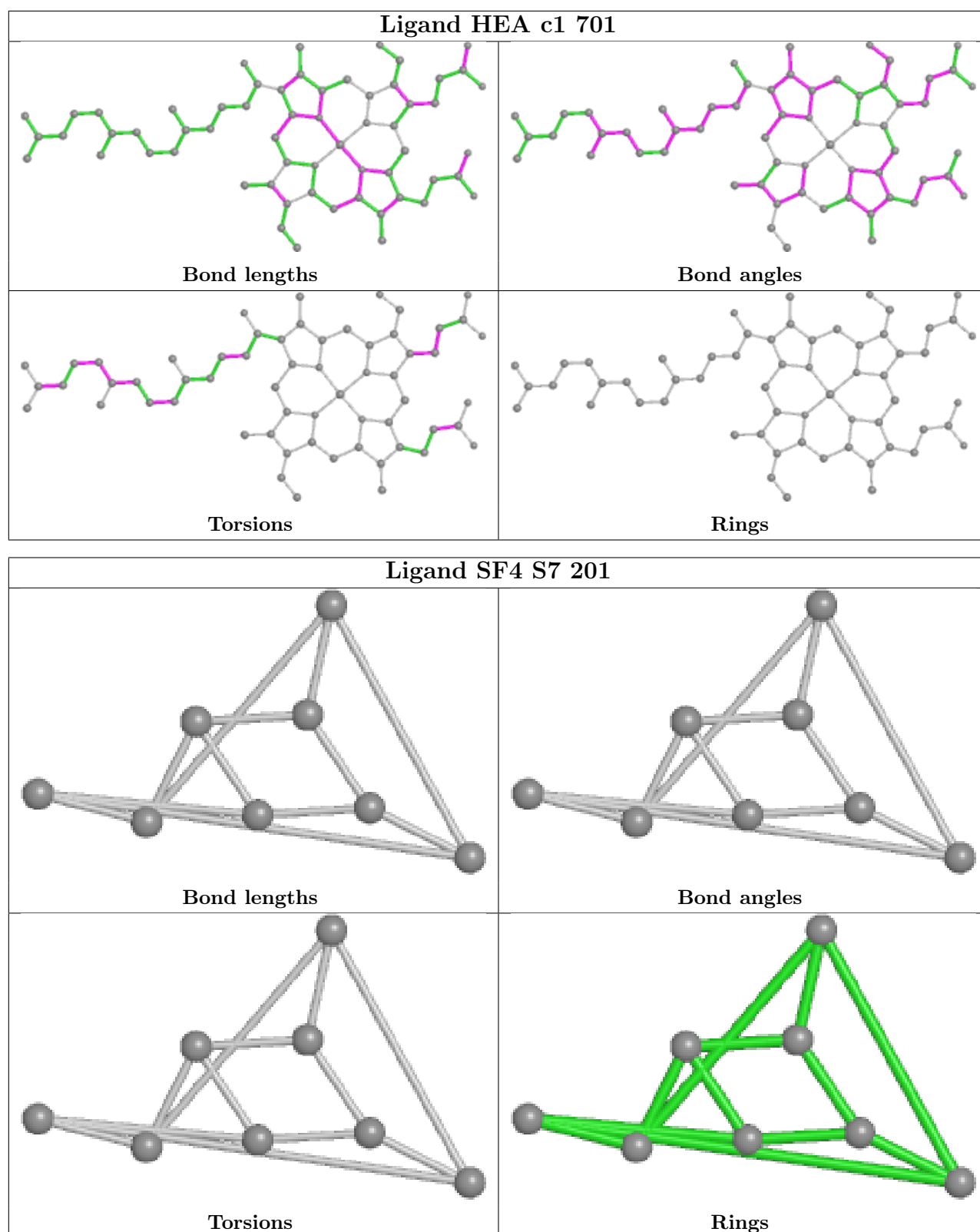

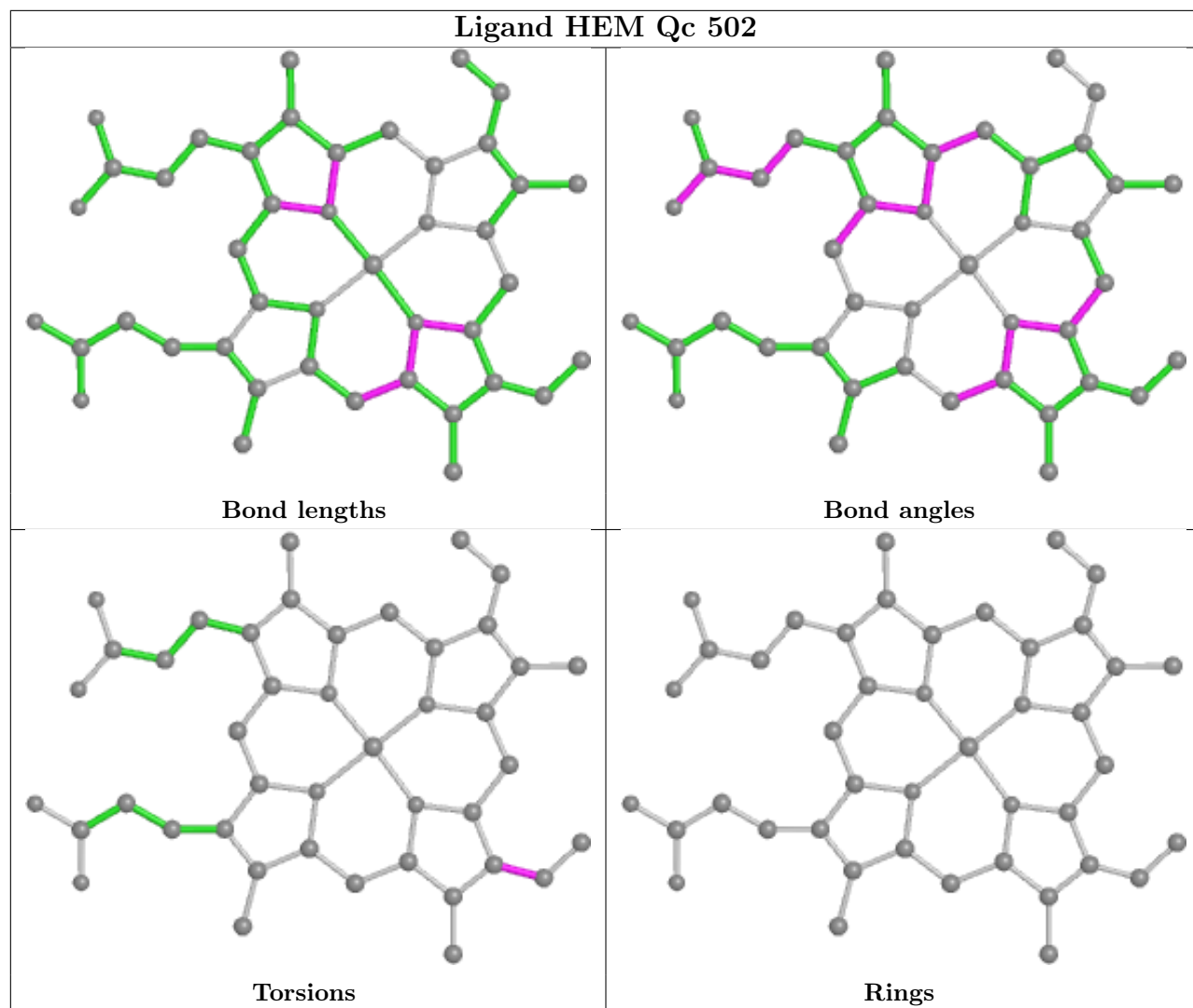

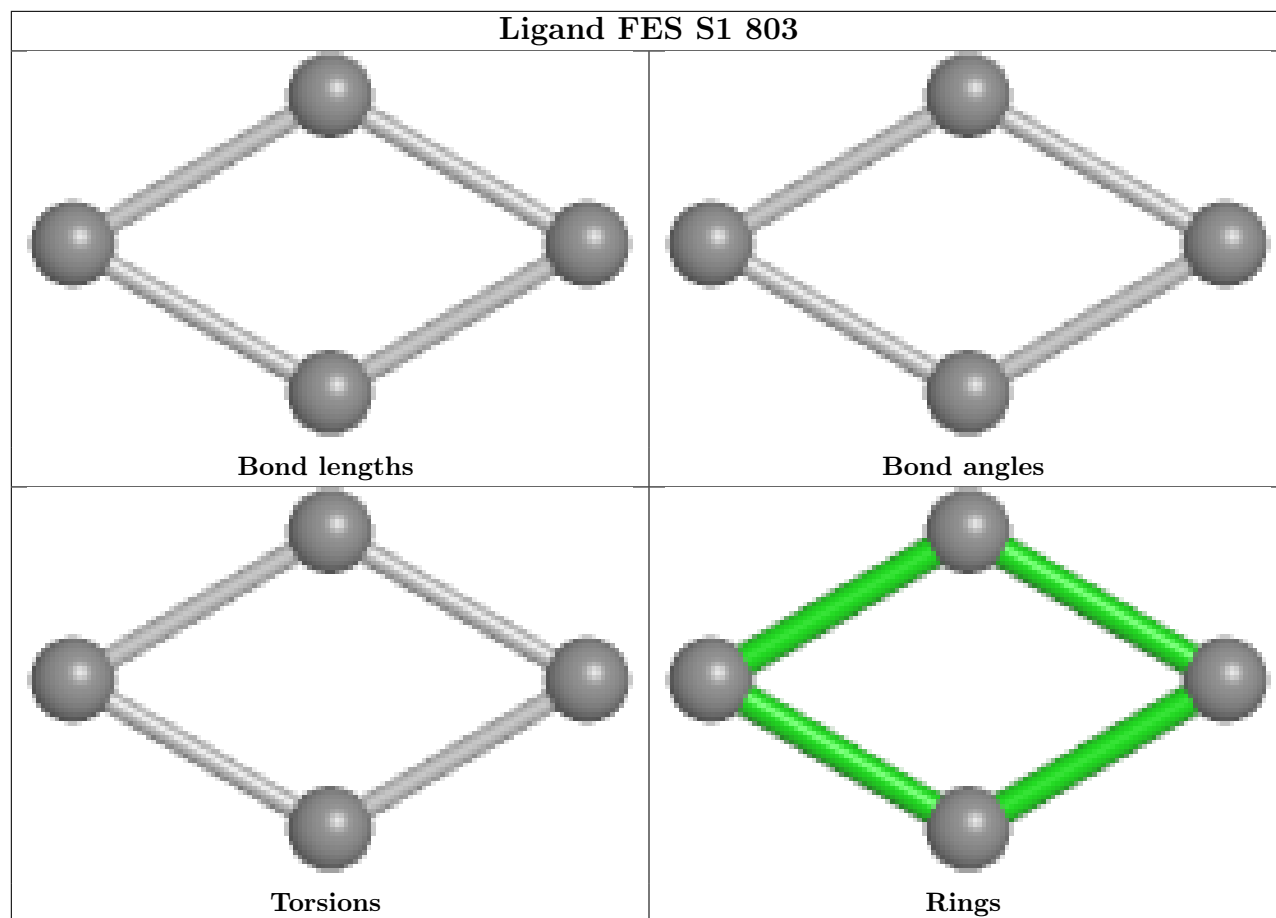

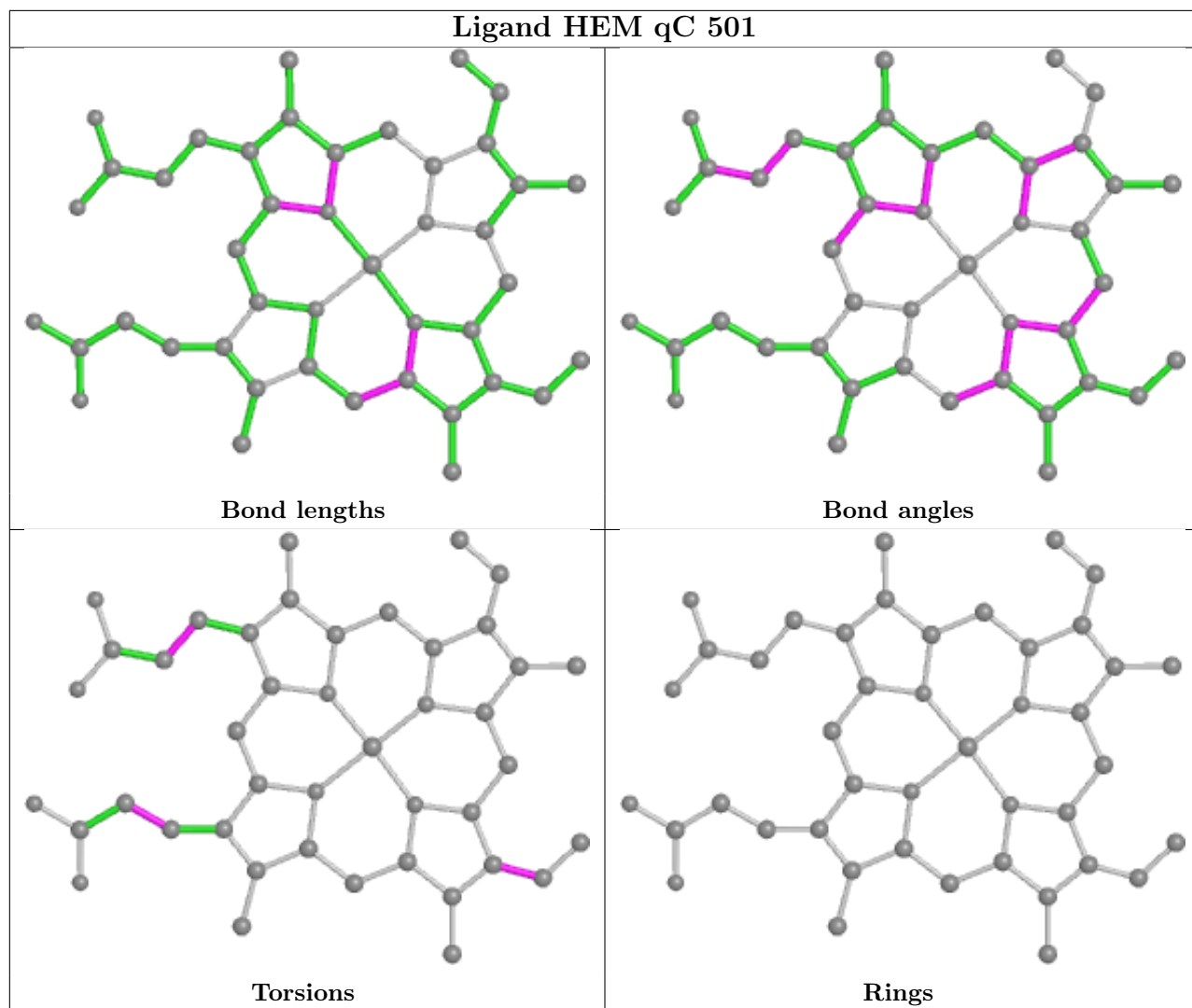

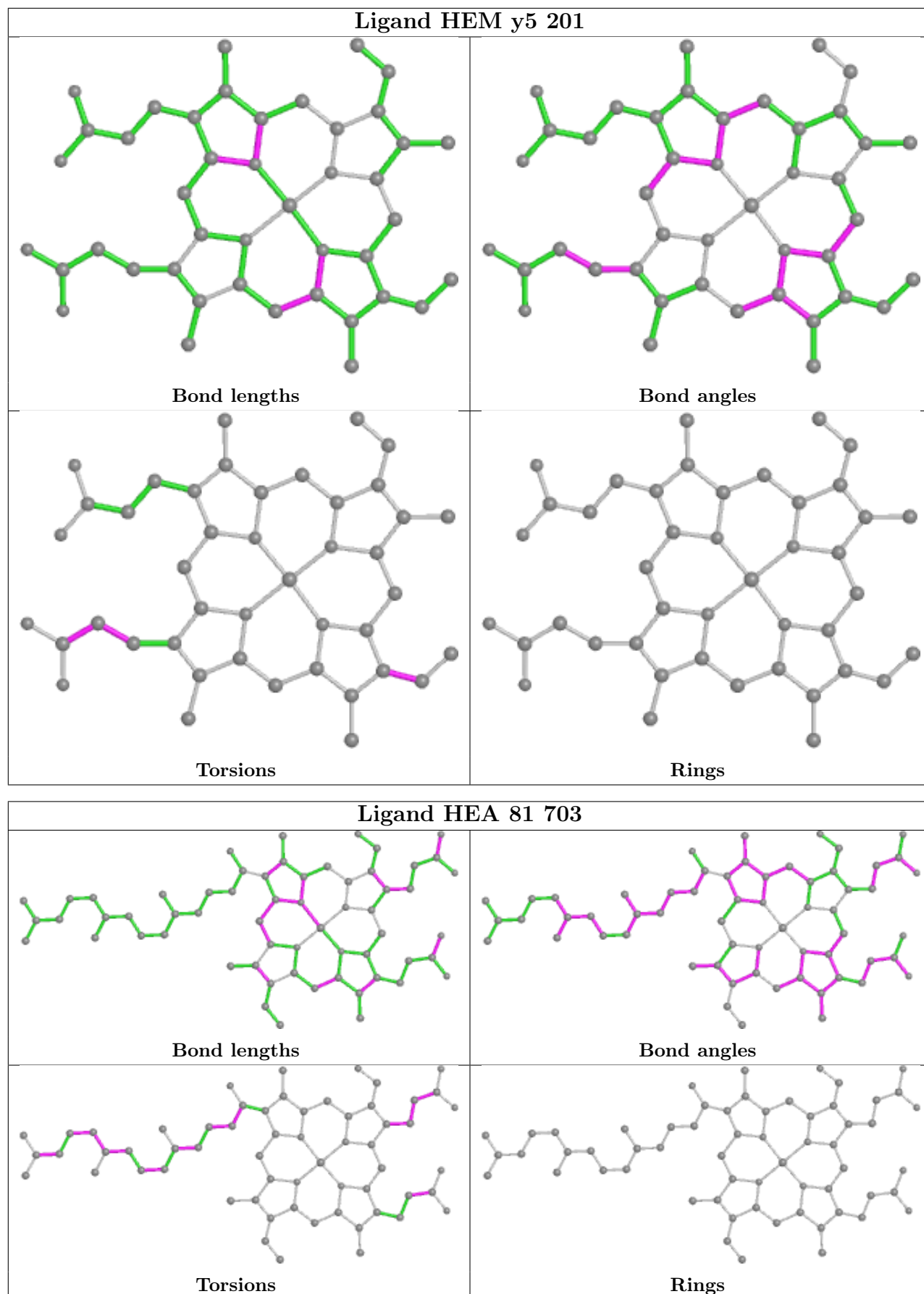

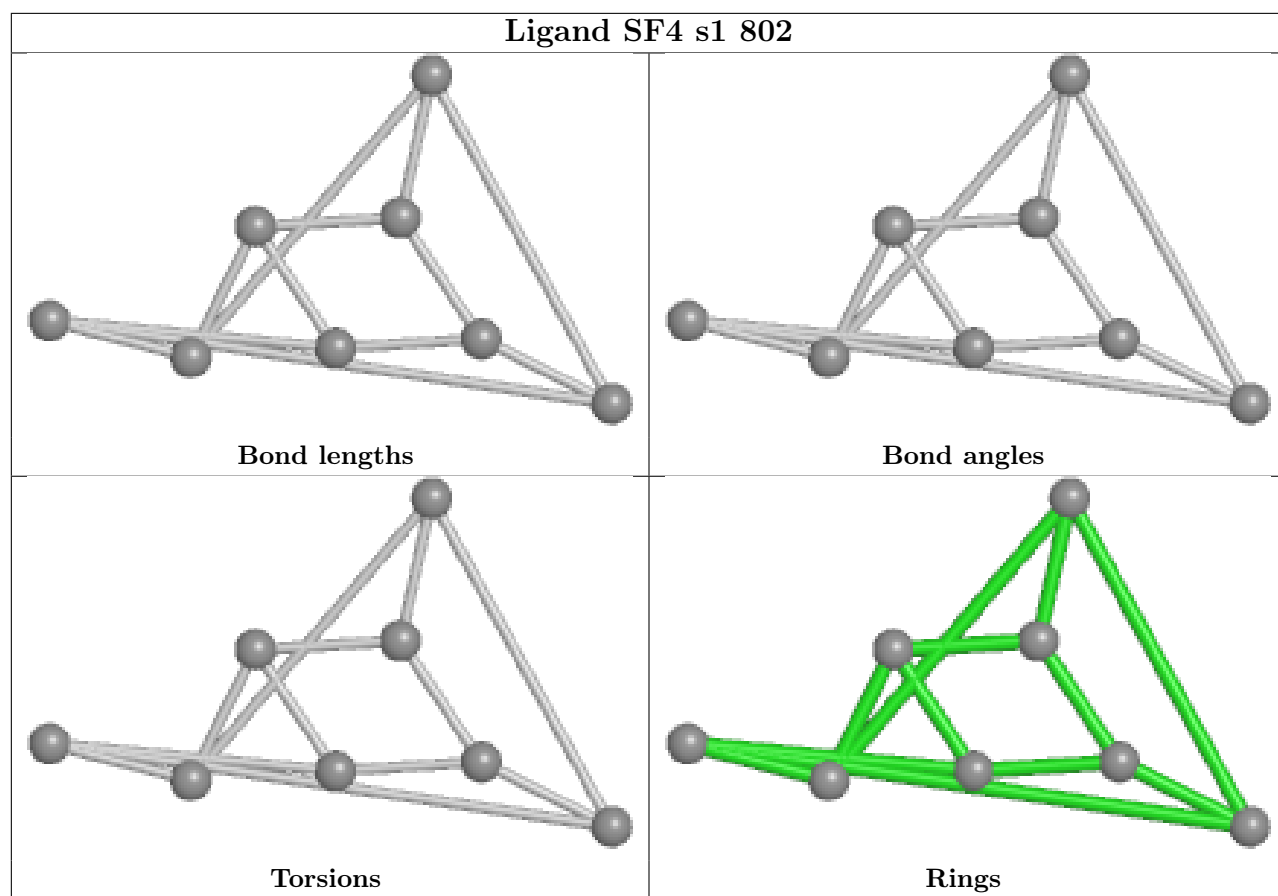
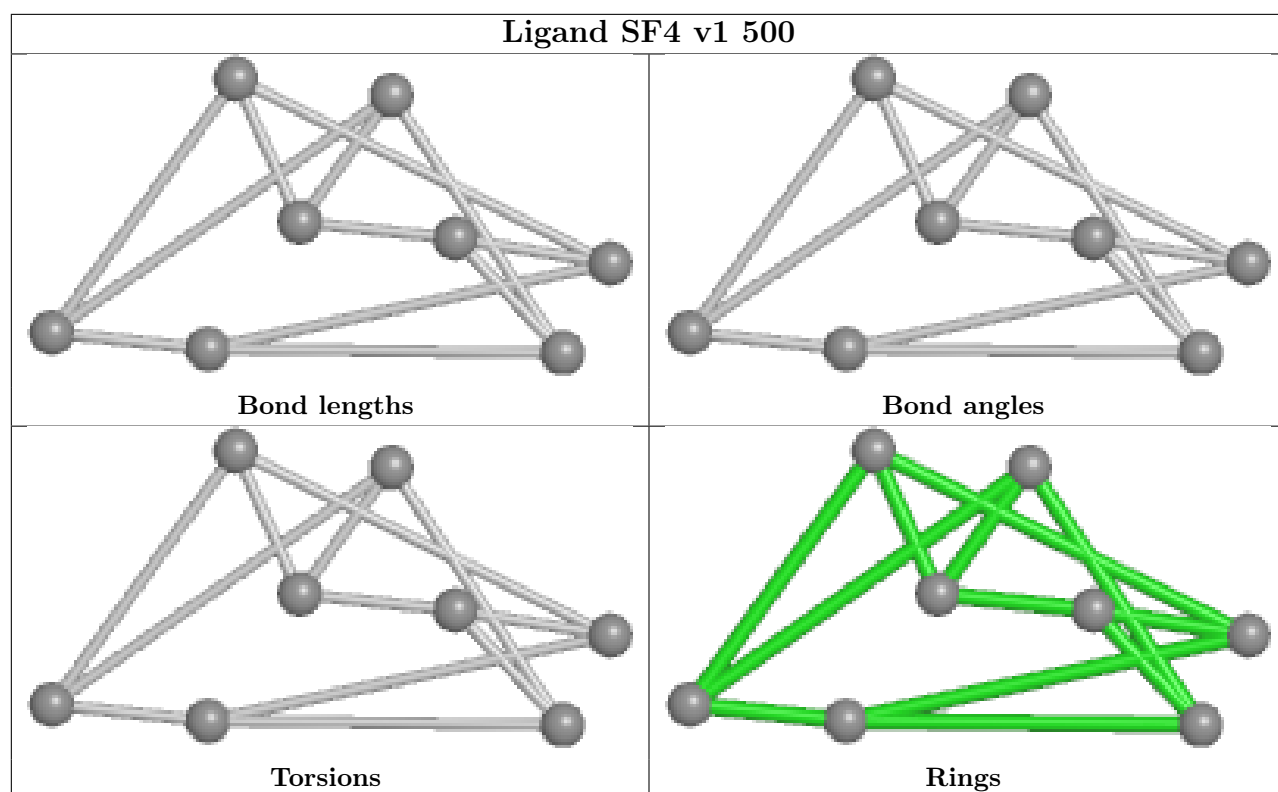

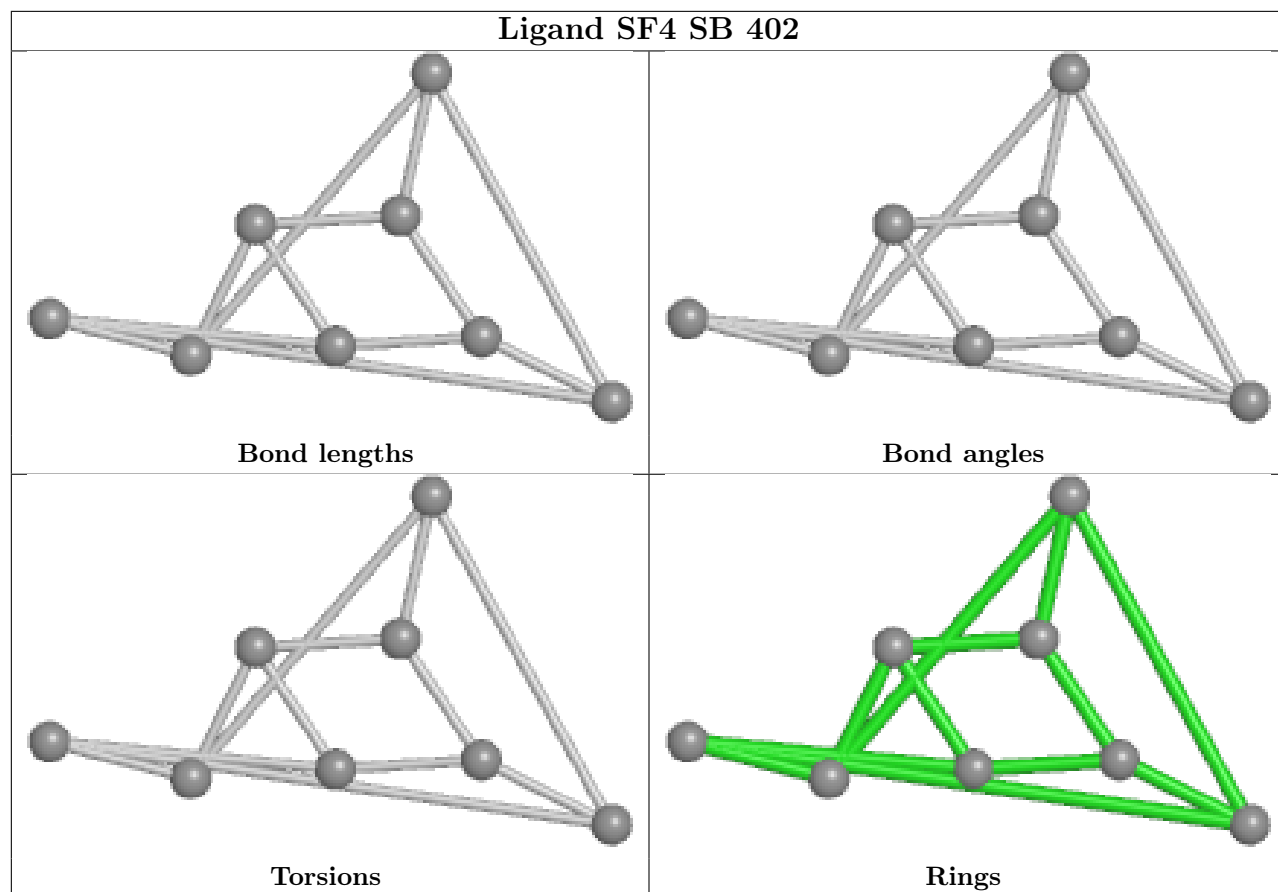



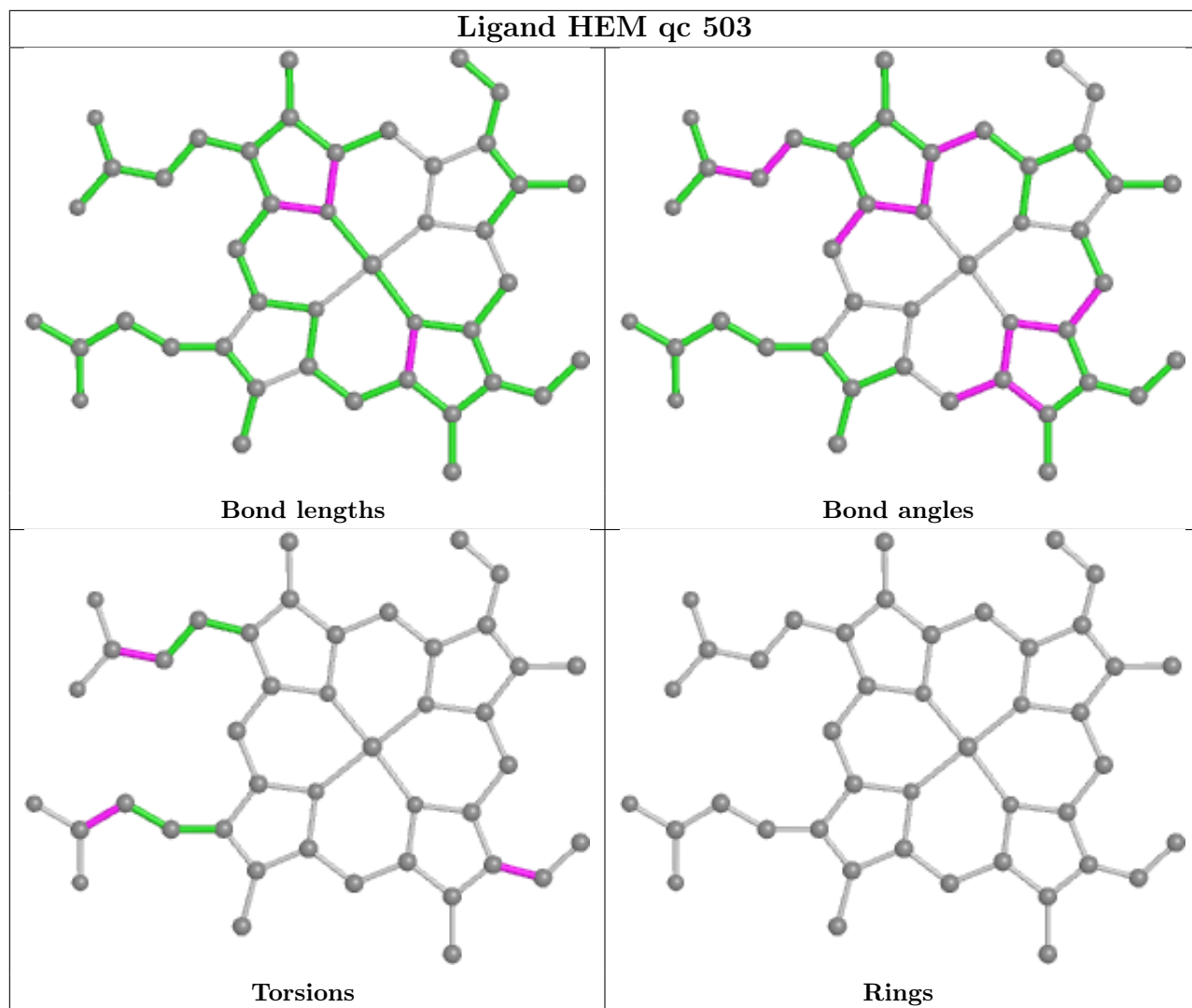

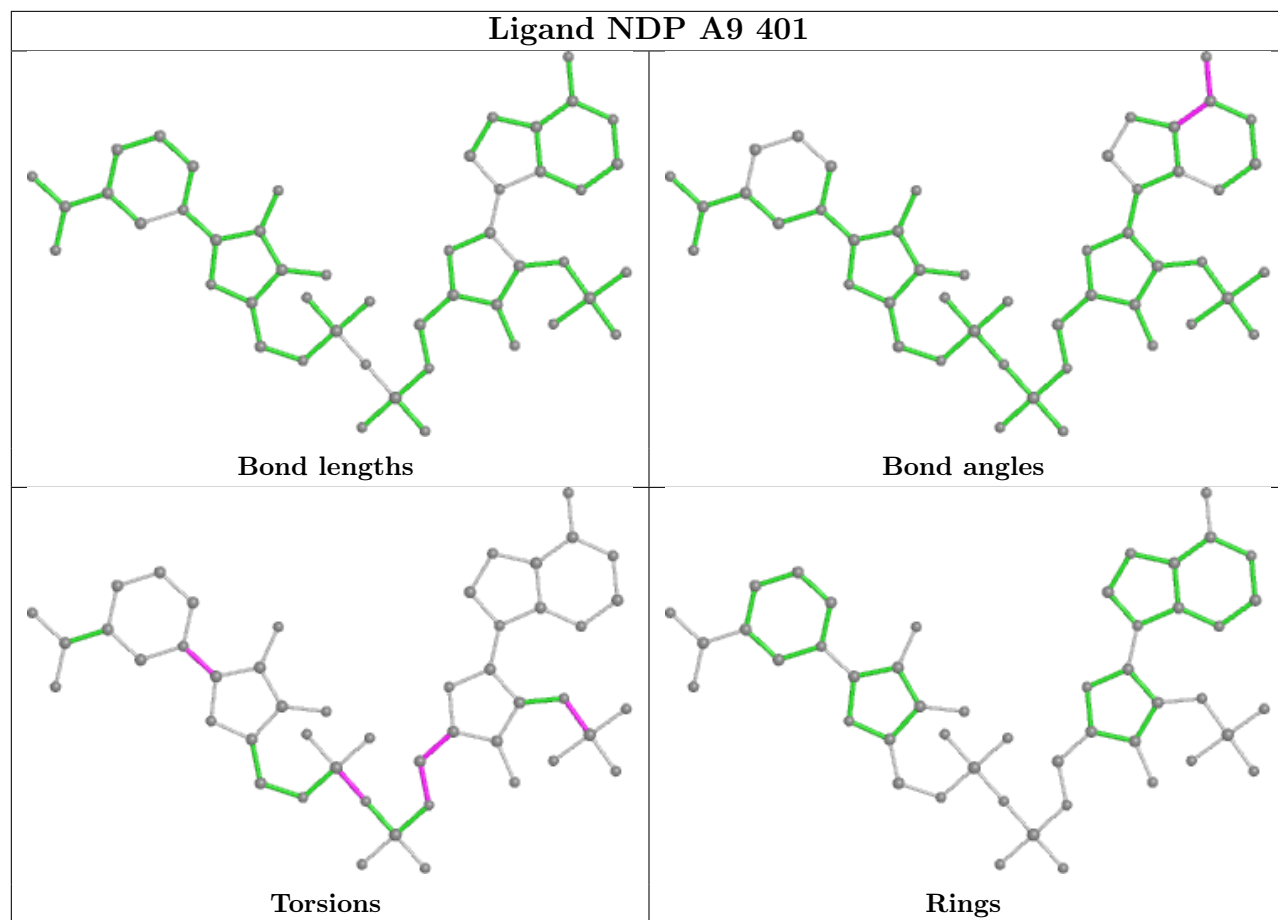

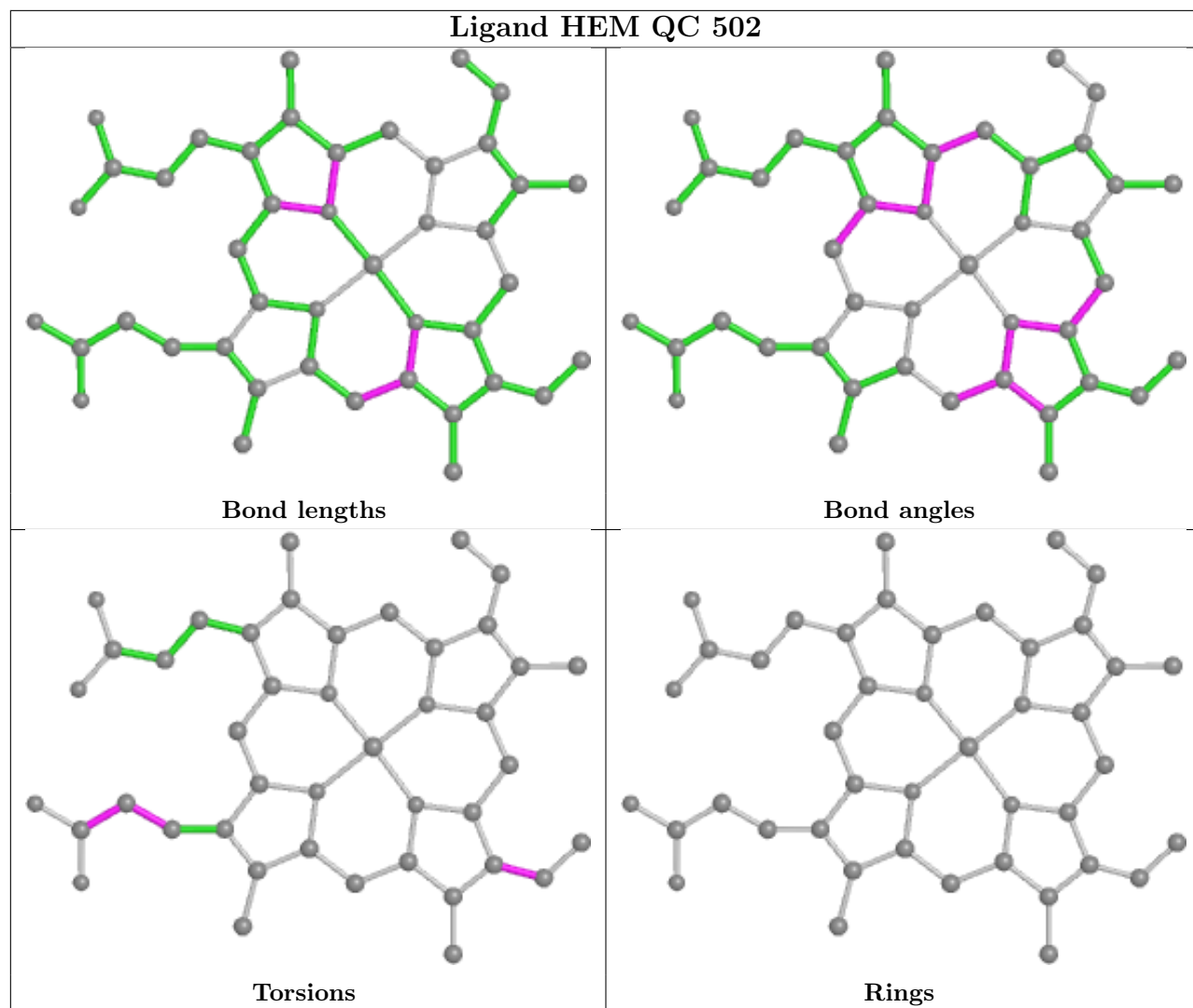

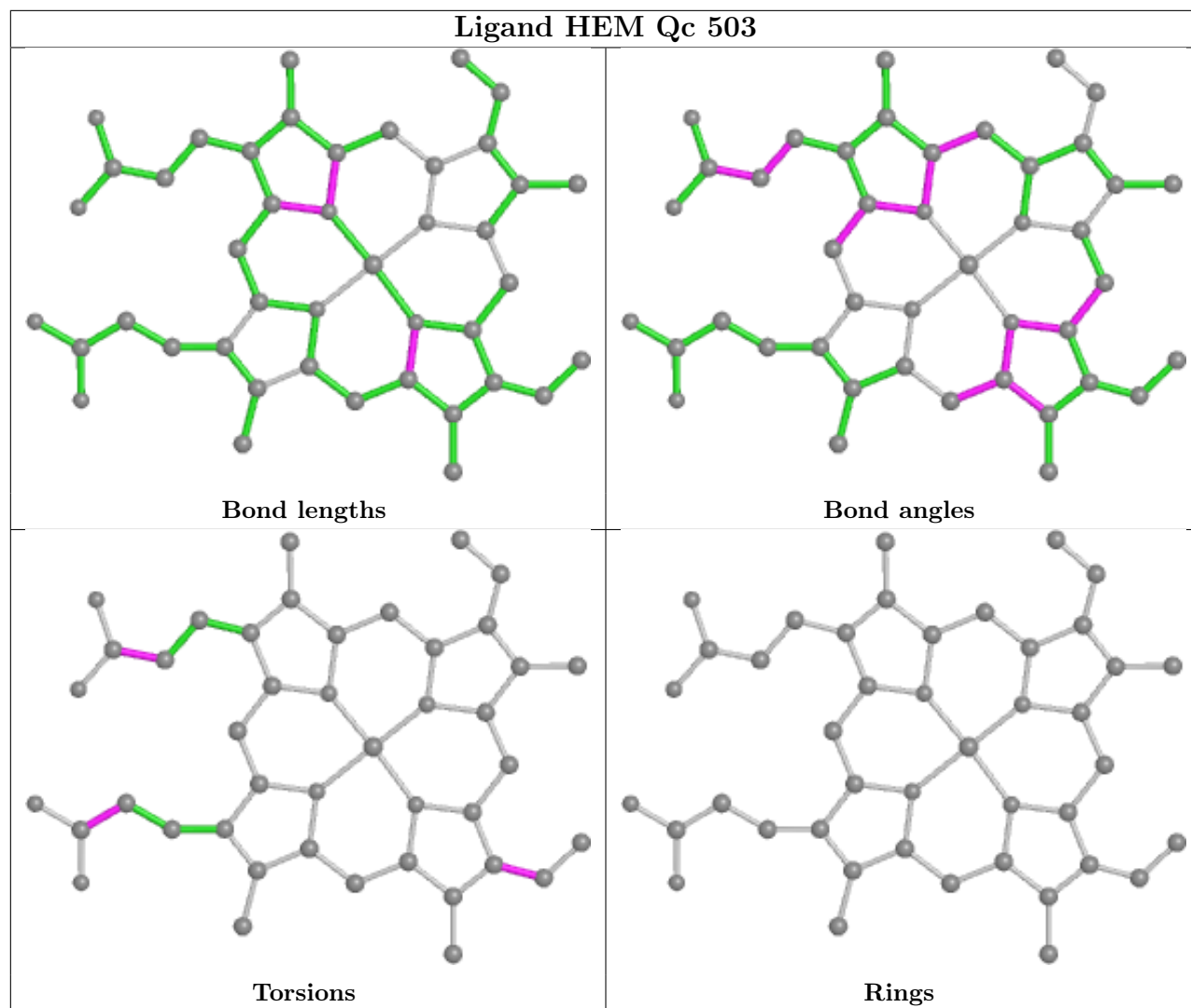

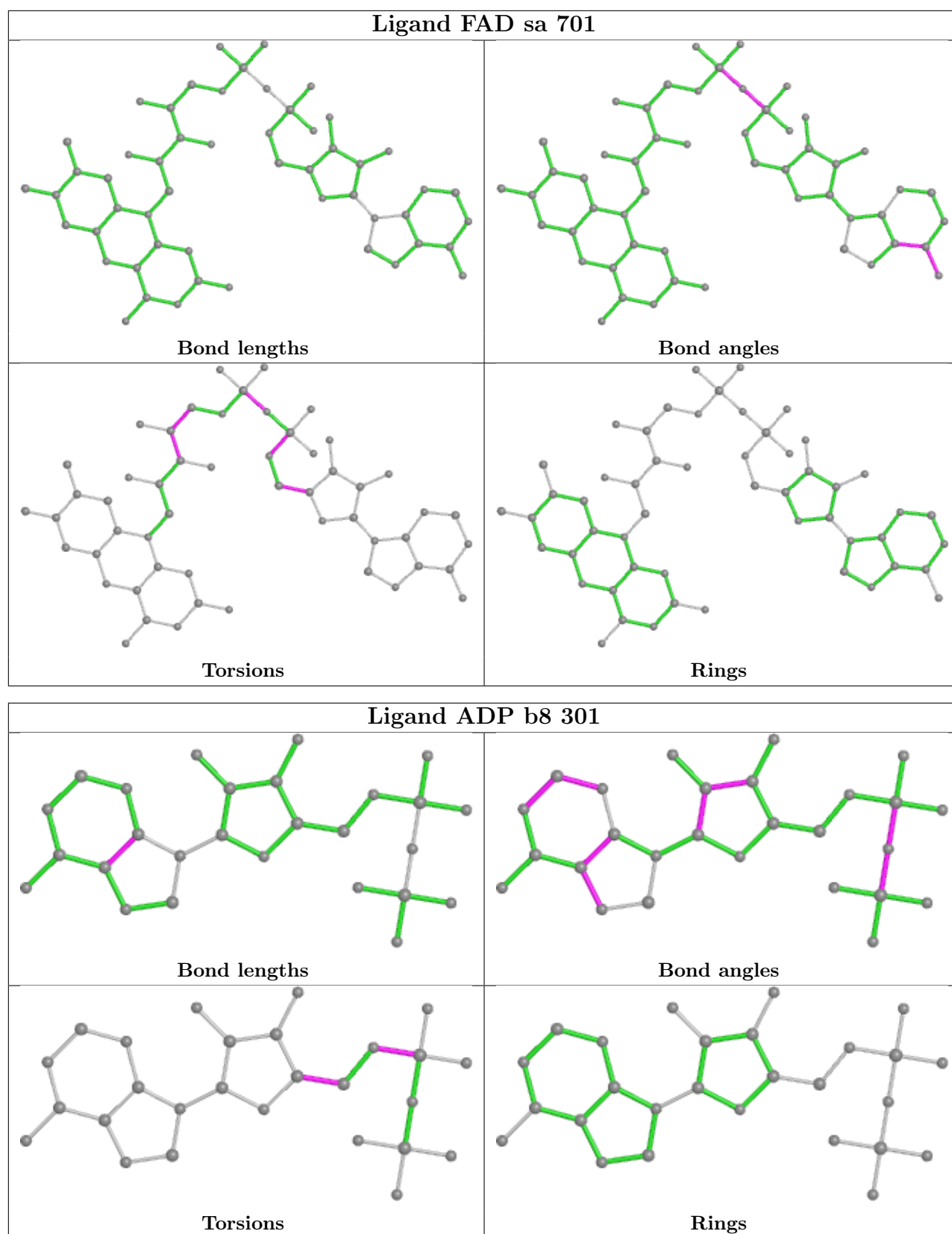

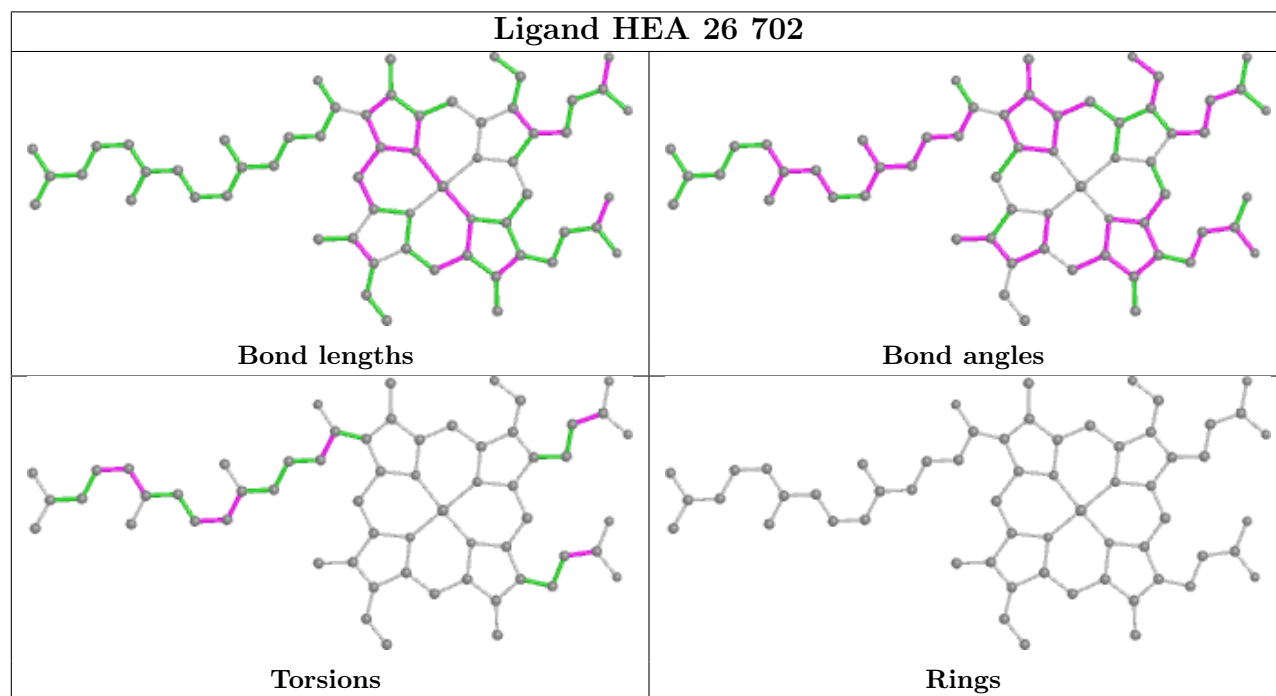
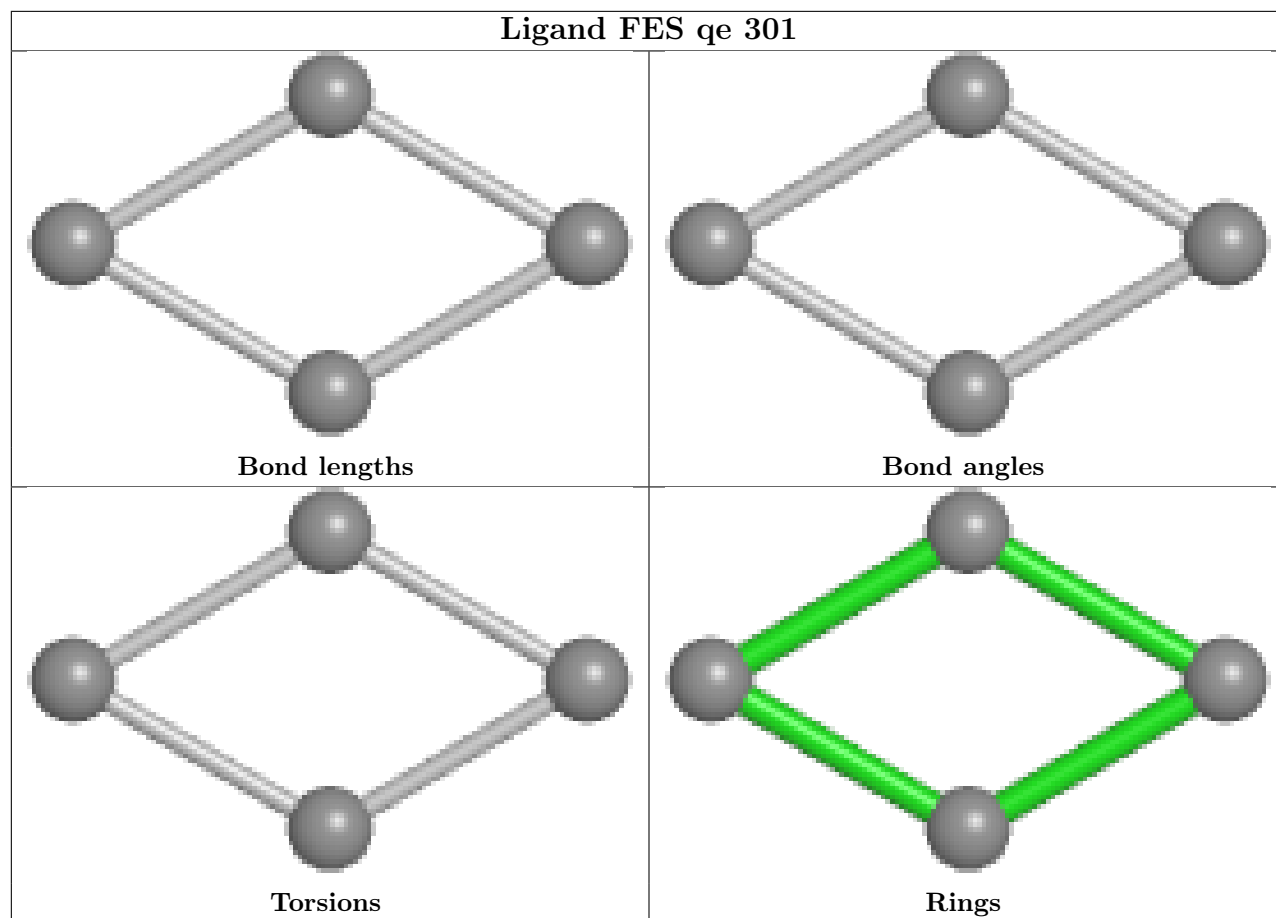

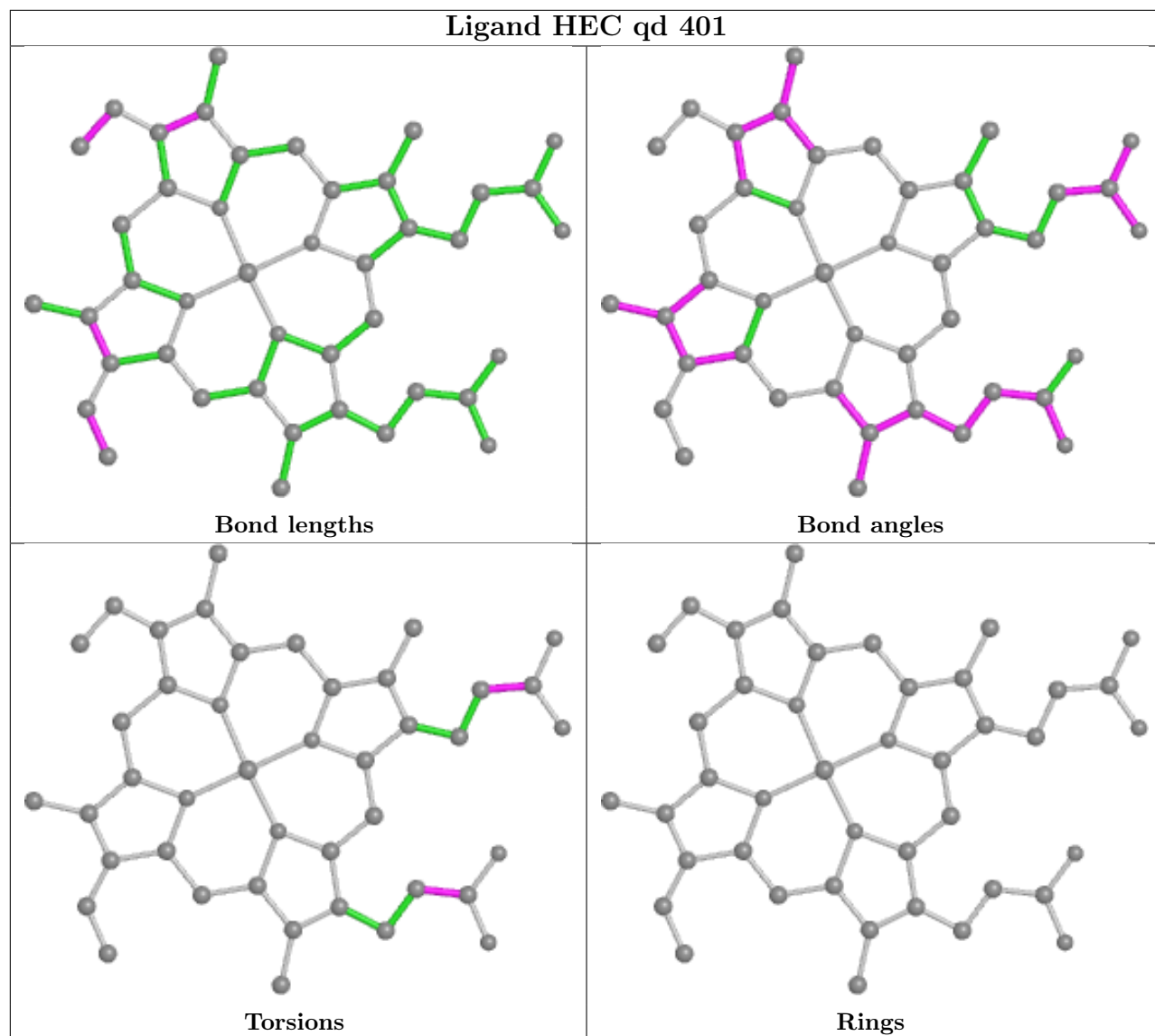

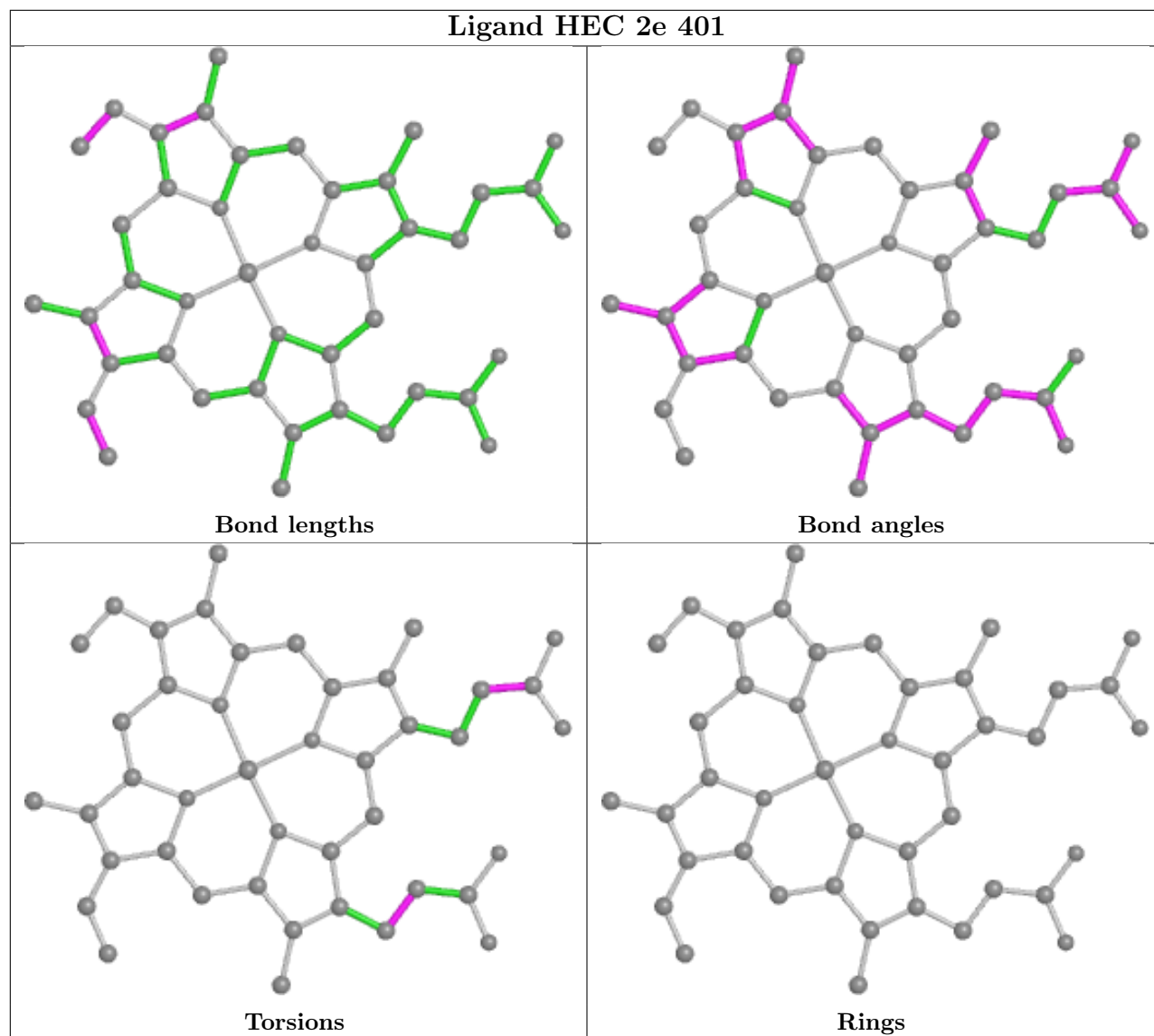



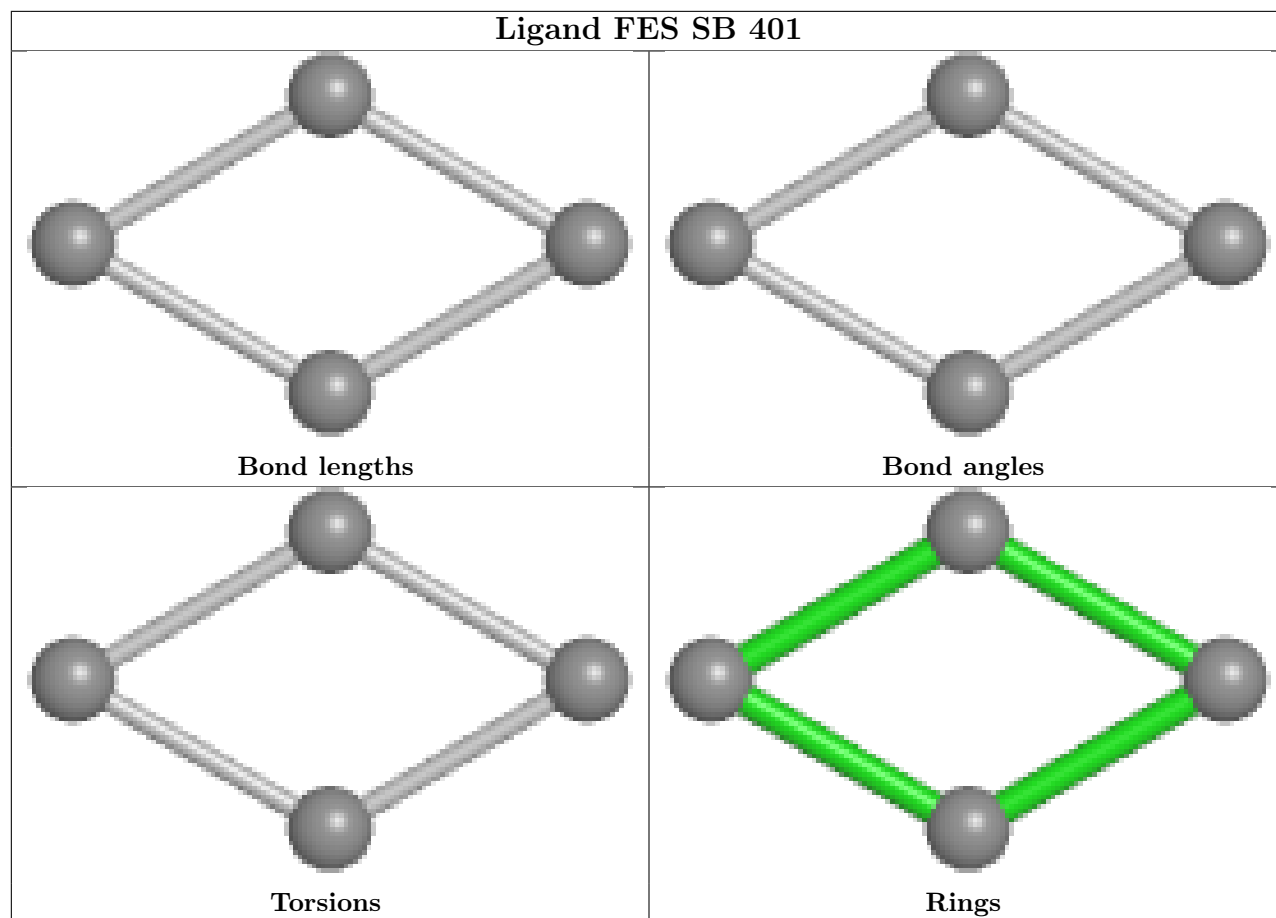

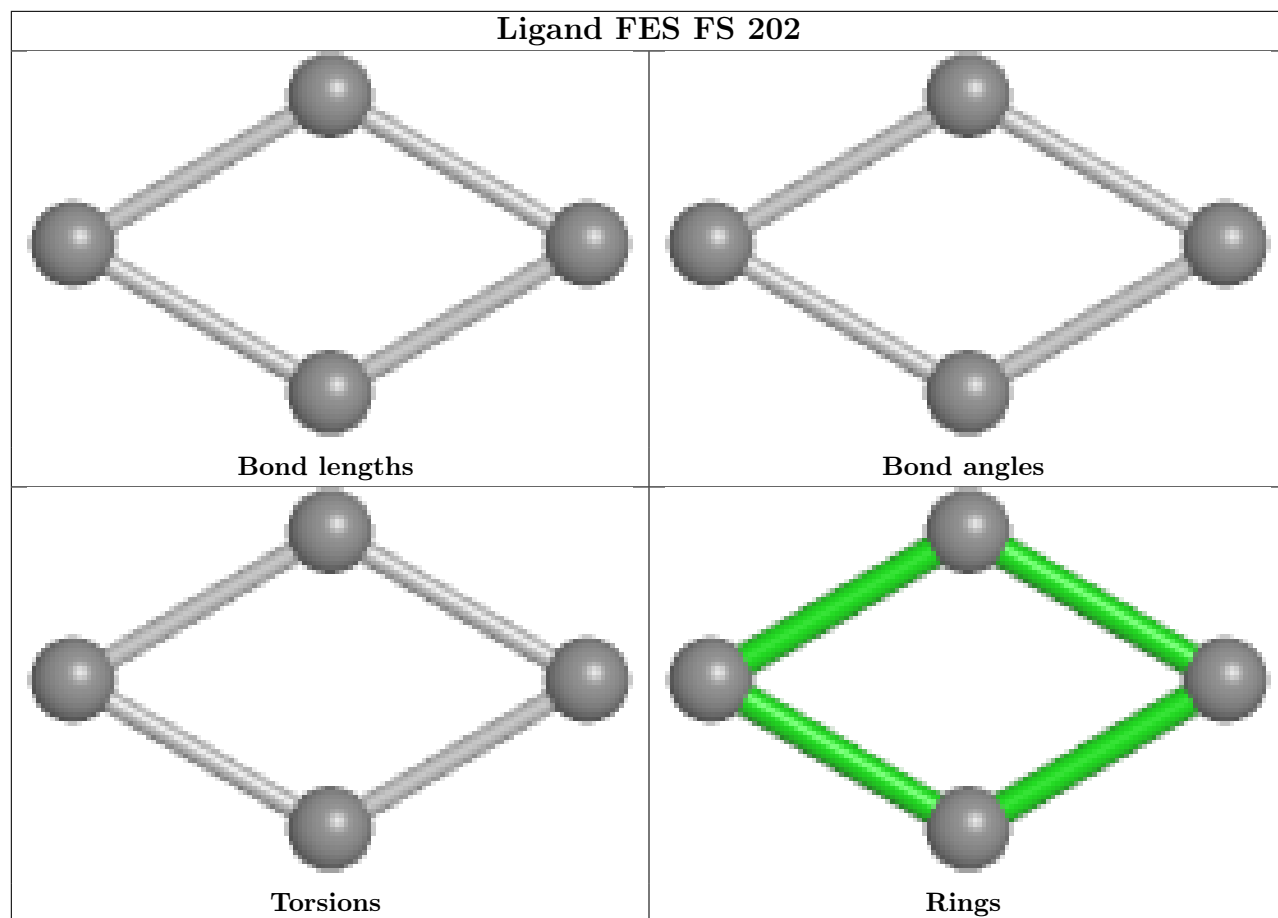

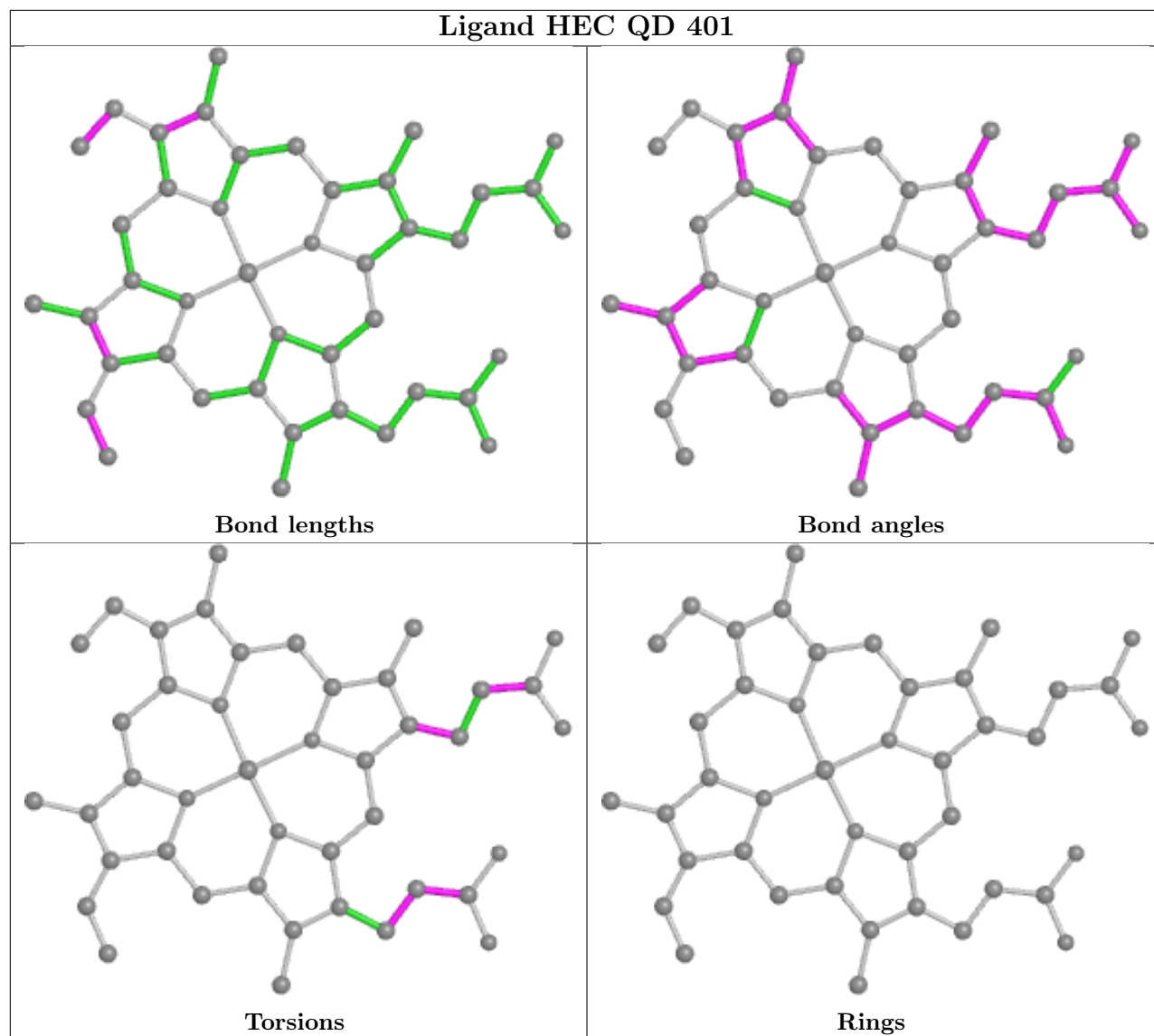

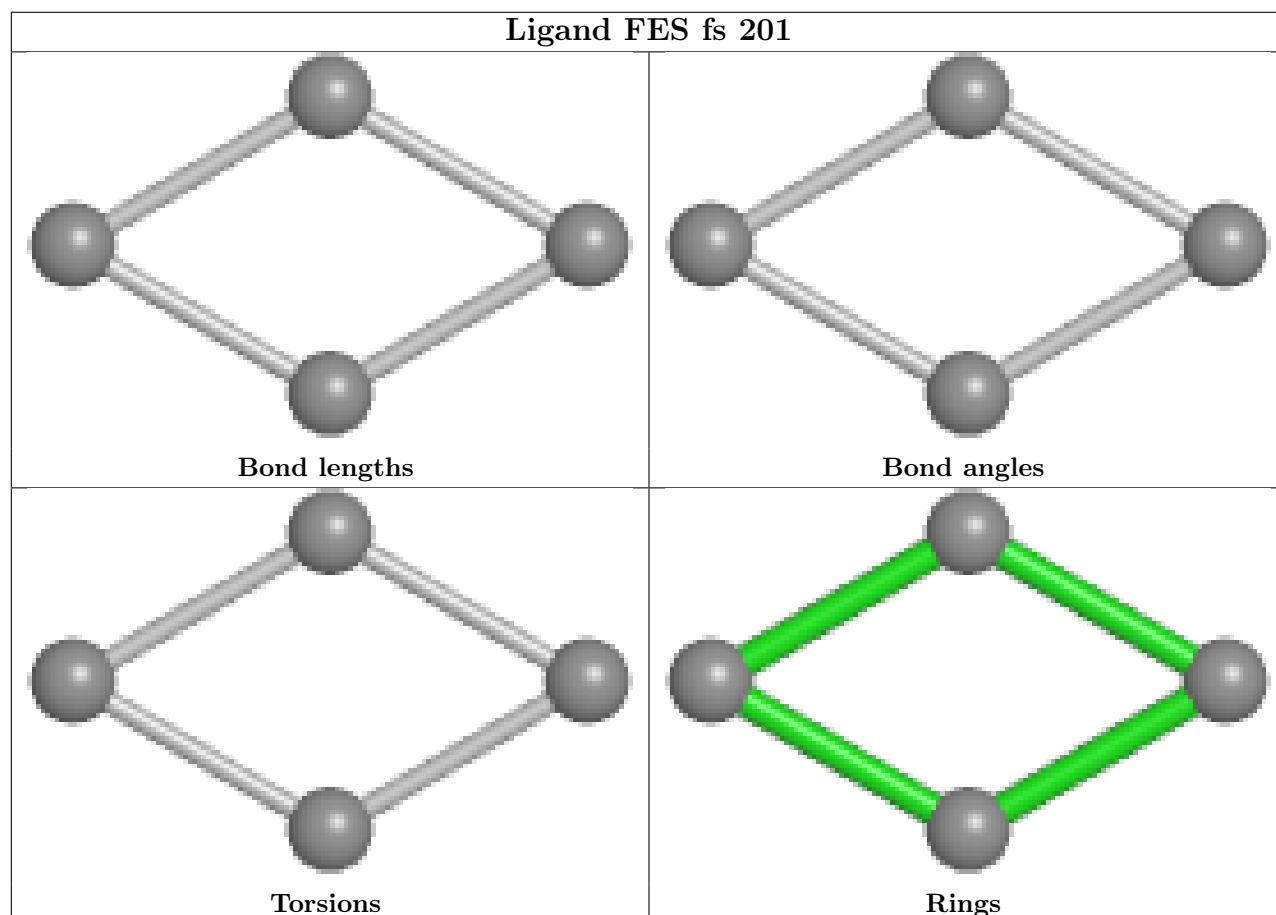
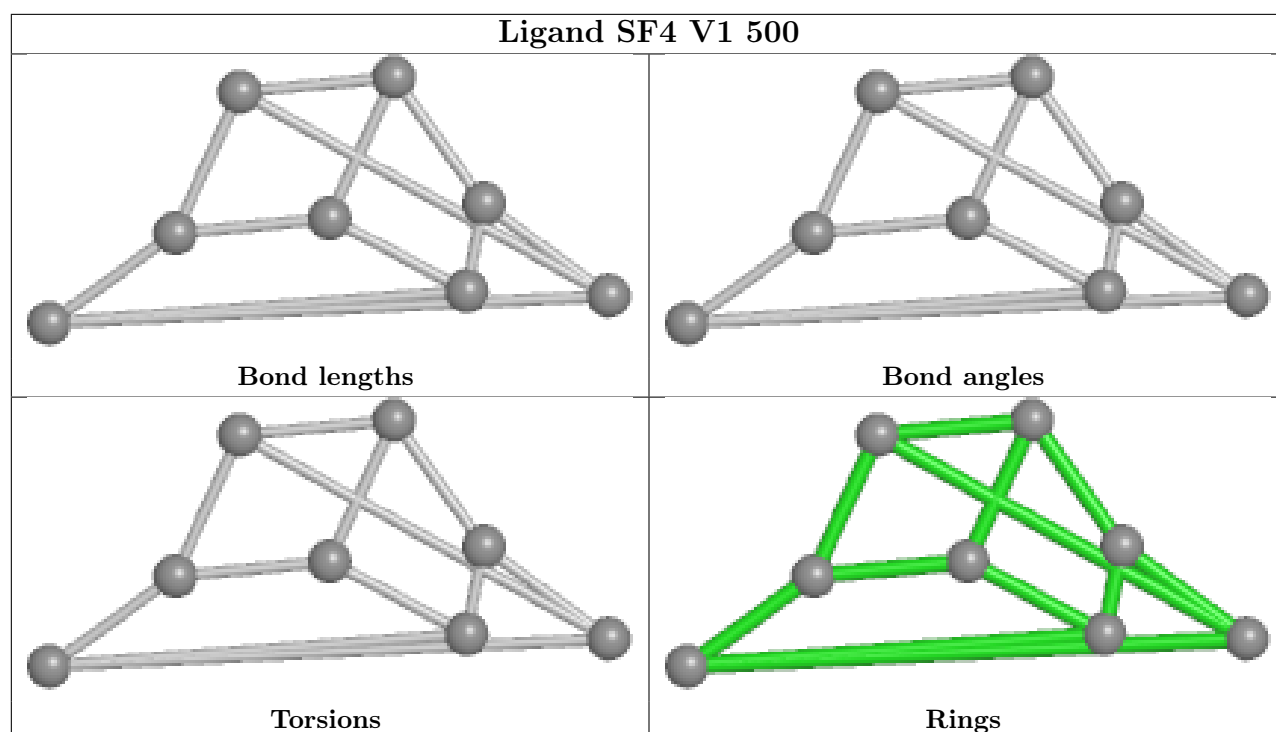

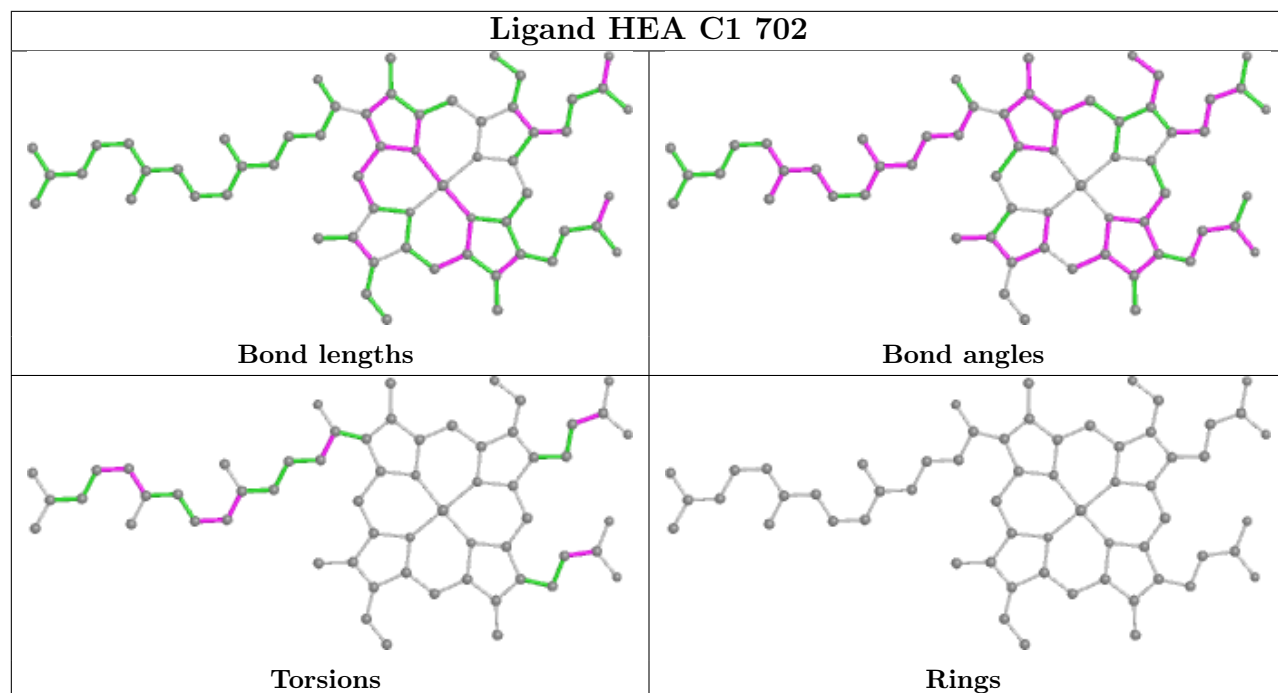

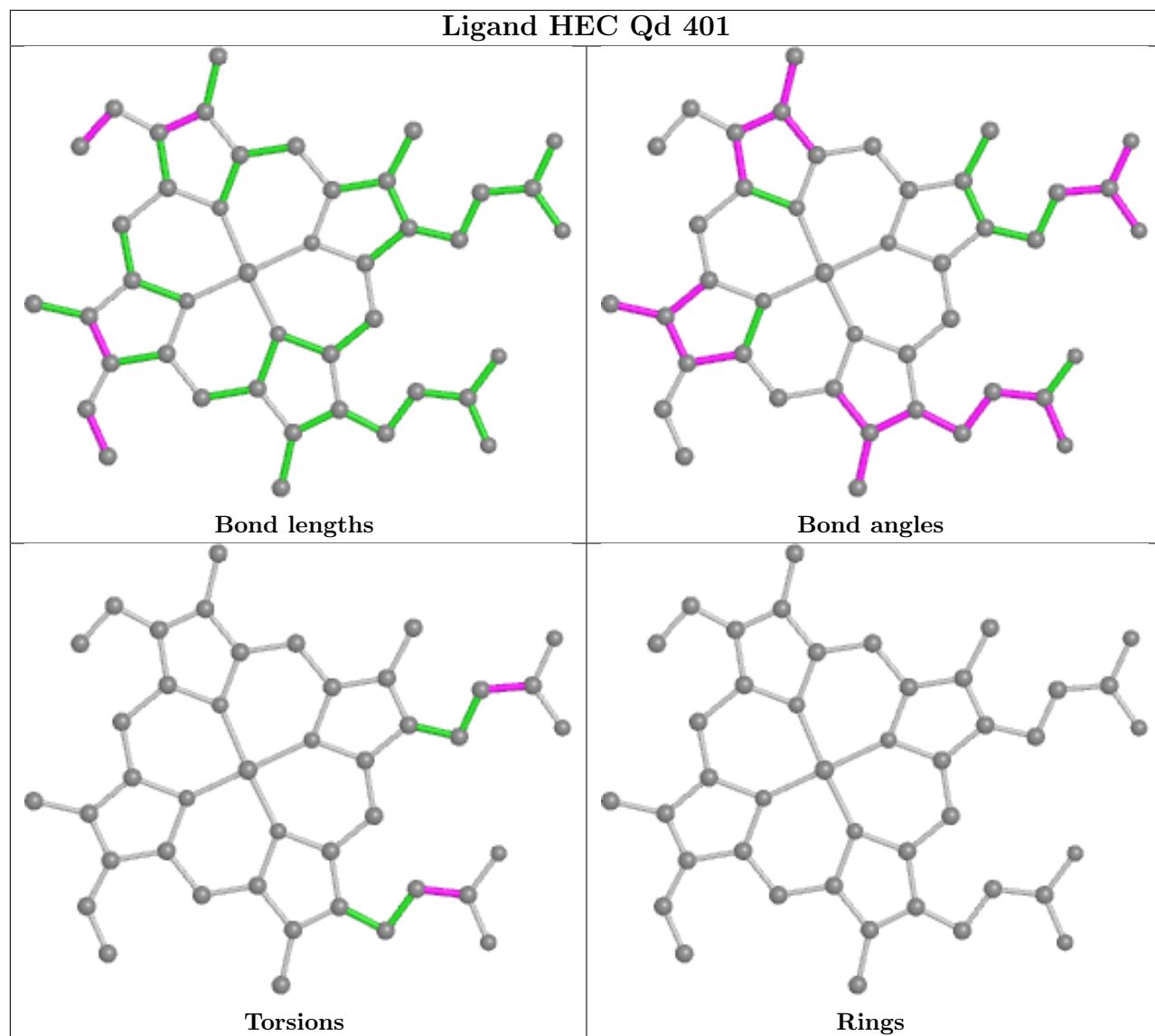

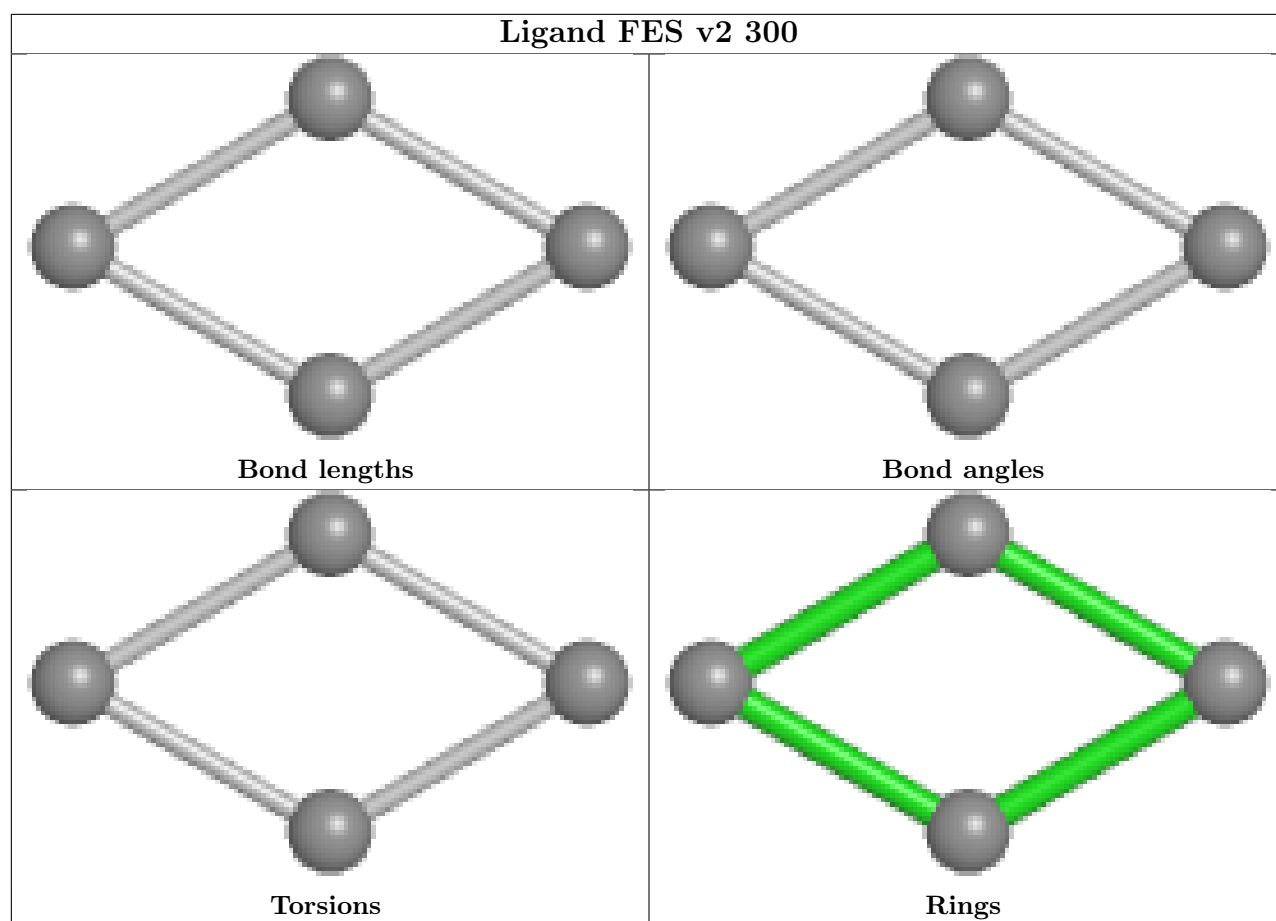

## 5.7 Other polymers [i](#)

There are no such residues in this entry.

## 5.8 Polymer linkage issues [i](#)

There are no chain breaks in this entry.

## 6 Map visualisation [i](#)

This section contains visualisations of the EMDB entry EMD-34403. These allow visual inspection of the internal detail of the map and identification of artifacts.

No raw map or half-maps were deposited for this entry and therefore no images, graphs, etc. pertaining to the raw map can be shown.

### 6.1 Orthogonal projections [i](#)

#### 6.1.1 Primary map

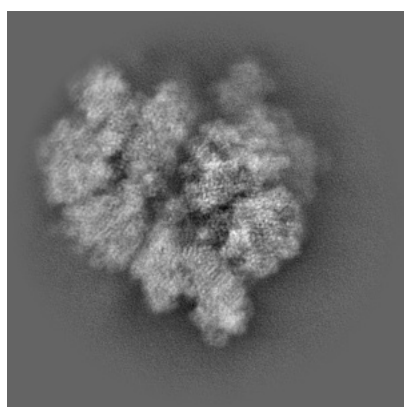

X

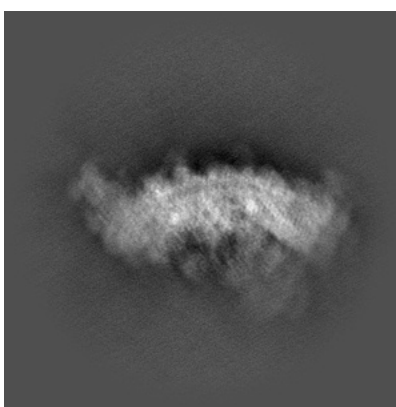

Y

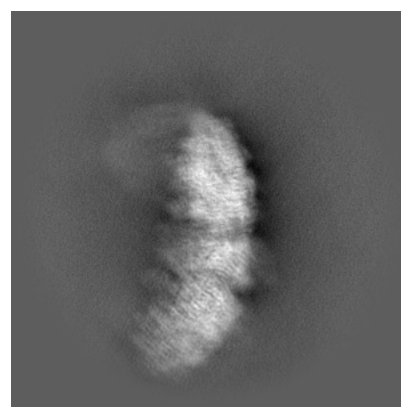

Z

The images above show the map projected in three orthogonal directions.

### 6.2 Central slices [i](#)

#### 6.2.1 Primary map

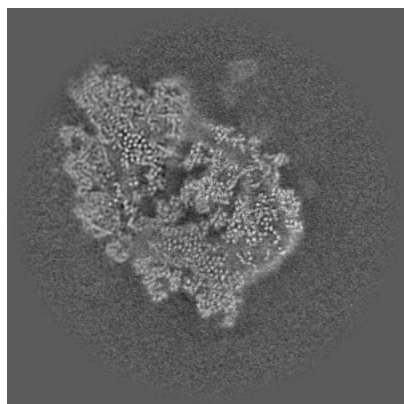

X Index: 350

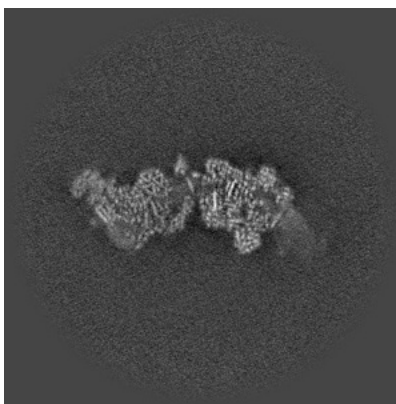

Y Index: 350

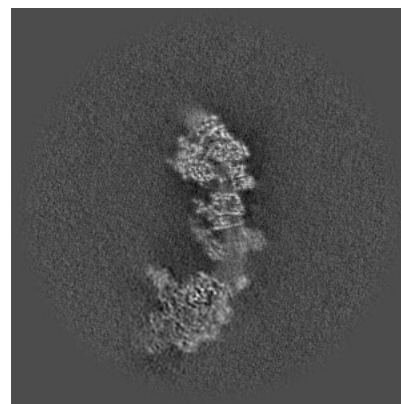

Z Index: 350



The images above show central slices of the map in three orthogonal directions.

## 6.3 Largest variance slices [\(i\)](#)

### 6.3.1 Primary map

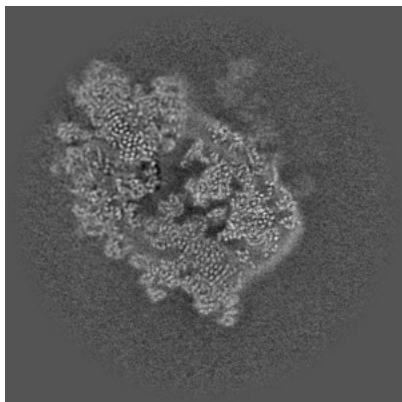

X Index: 344

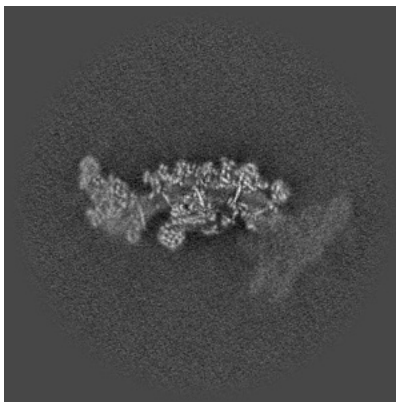

Y Index: 401

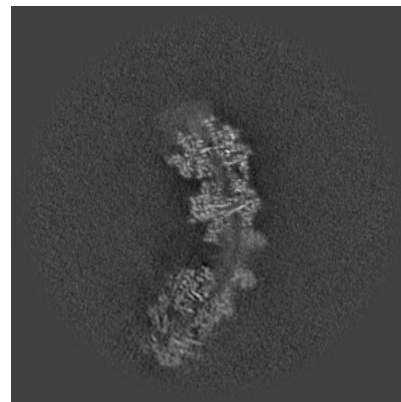

Z Index: 367

The images above show the largest variance slices of the map in three orthogonal directions.

## 6.4 Orthogonal standard-deviation projections (False-color) [\(i\)](#)

### 6.4.1 Primary map

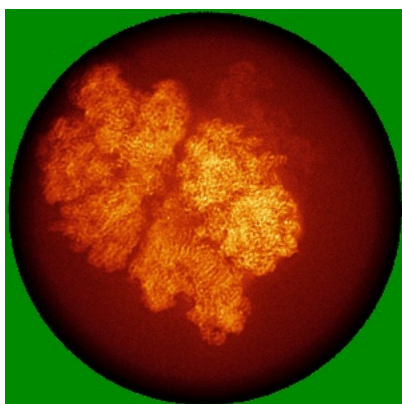

X

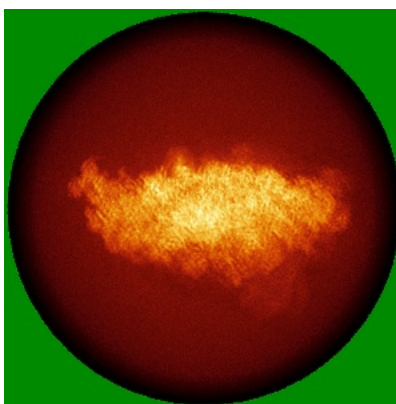

Y

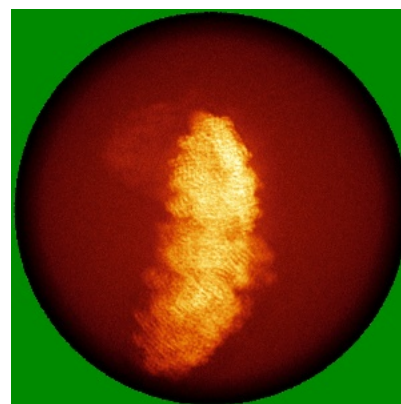

Z

The images above show the map standard deviation projections with false color in three orthogonal directions. Minimum values are shown in green, max in blue, and dark to light orange shades represent small to large values respectively.

## 6.5 Orthogonal surface views [i](#)

### 6.5.1 Primary map



X



Y

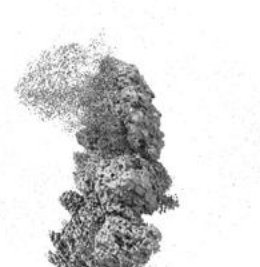

Z

The images above show the 3D surface view of the map at the recommended contour level 4.0. These images, in conjunction with the slice images, may facilitate assessment of whether an appropriate contour level has been provided.

## 6.6 Mask visualisation [i](#)

This section was not generated. No masks/segmentation were deposited.

## 7 Map analysis [i](#)

This section contains the results of statistical analysis of the map.

### 7.1 Map-value distribution [i](#)

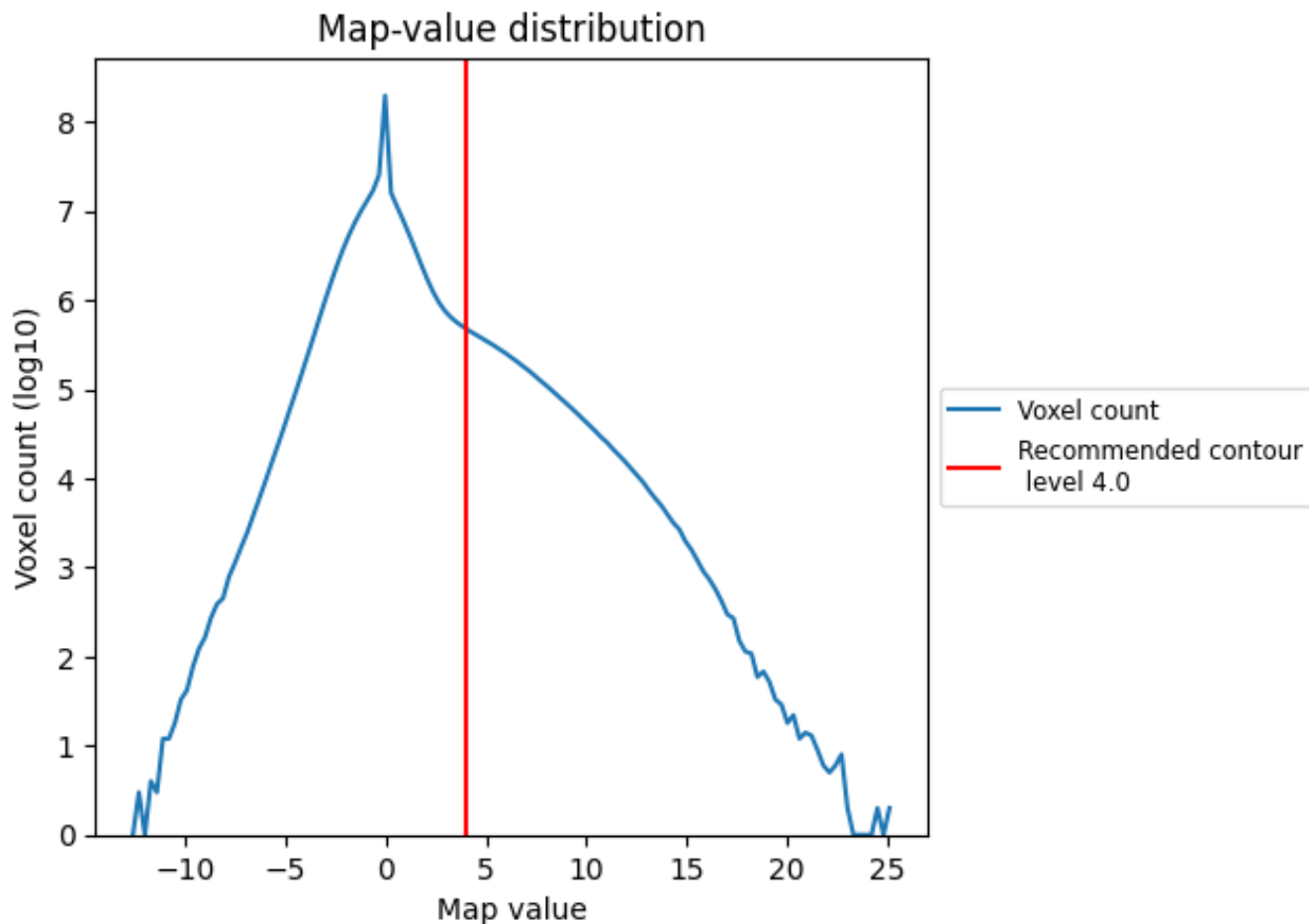

The map-value distribution is plotted in 128 intervals along the x-axis. The y-axis is logarithmic. A spike in this graph at zero usually indicates that the volume has been masked.

## 7.2 Volume estimate [i](#)

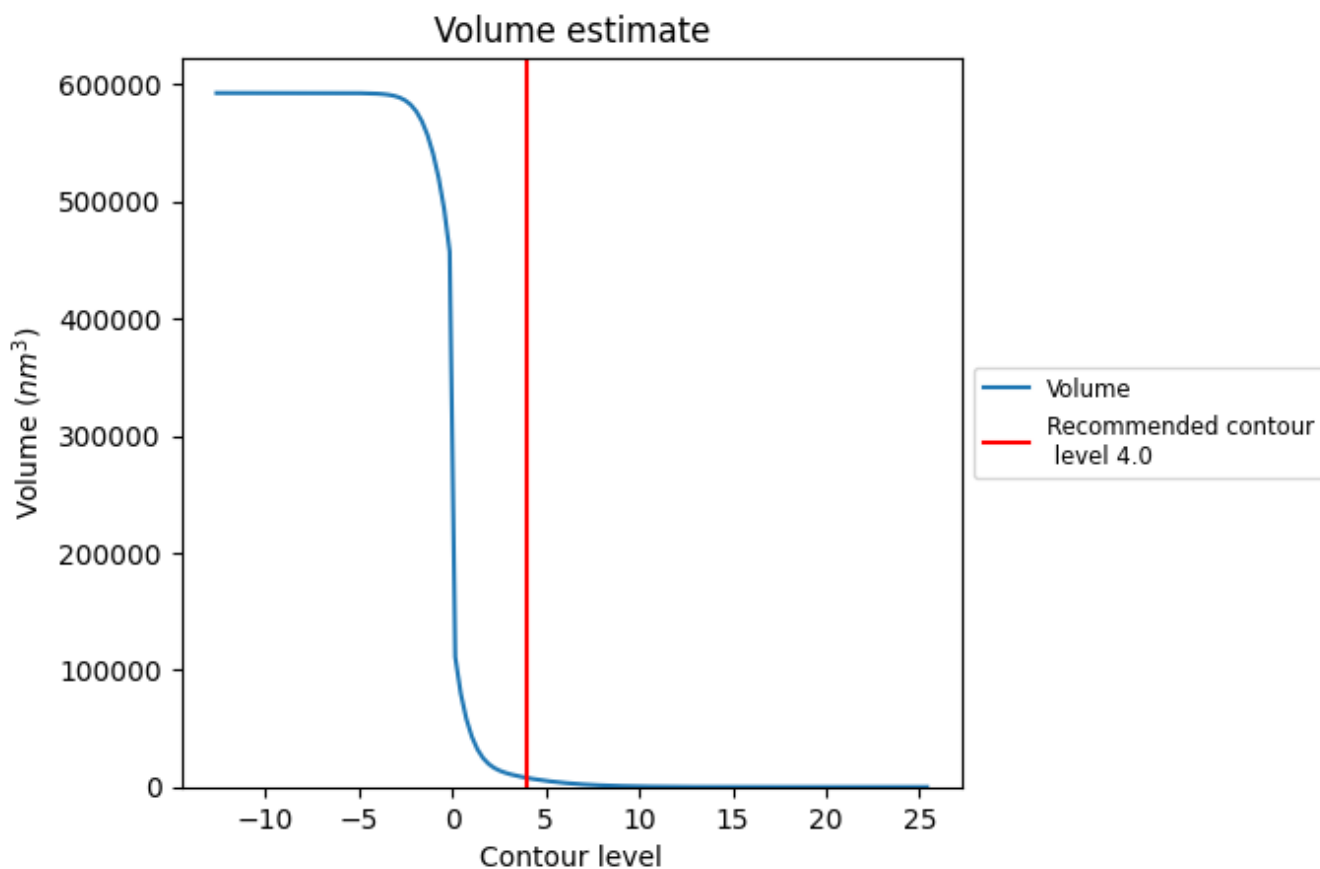

The volume at the recommended contour level is 77333 nm<sup>3</sup>; this corresponds to an approximate mass of 6985 kDa.

The volume estimate graph shows how the enclosed volume varies with the contour level. The recommended contour level is shown as a vertical line and the intersection between the line and the curve gives the volume of the enclosed surface at the given level.

### 7.3 Rotationally averaged power spectrum [i](#)

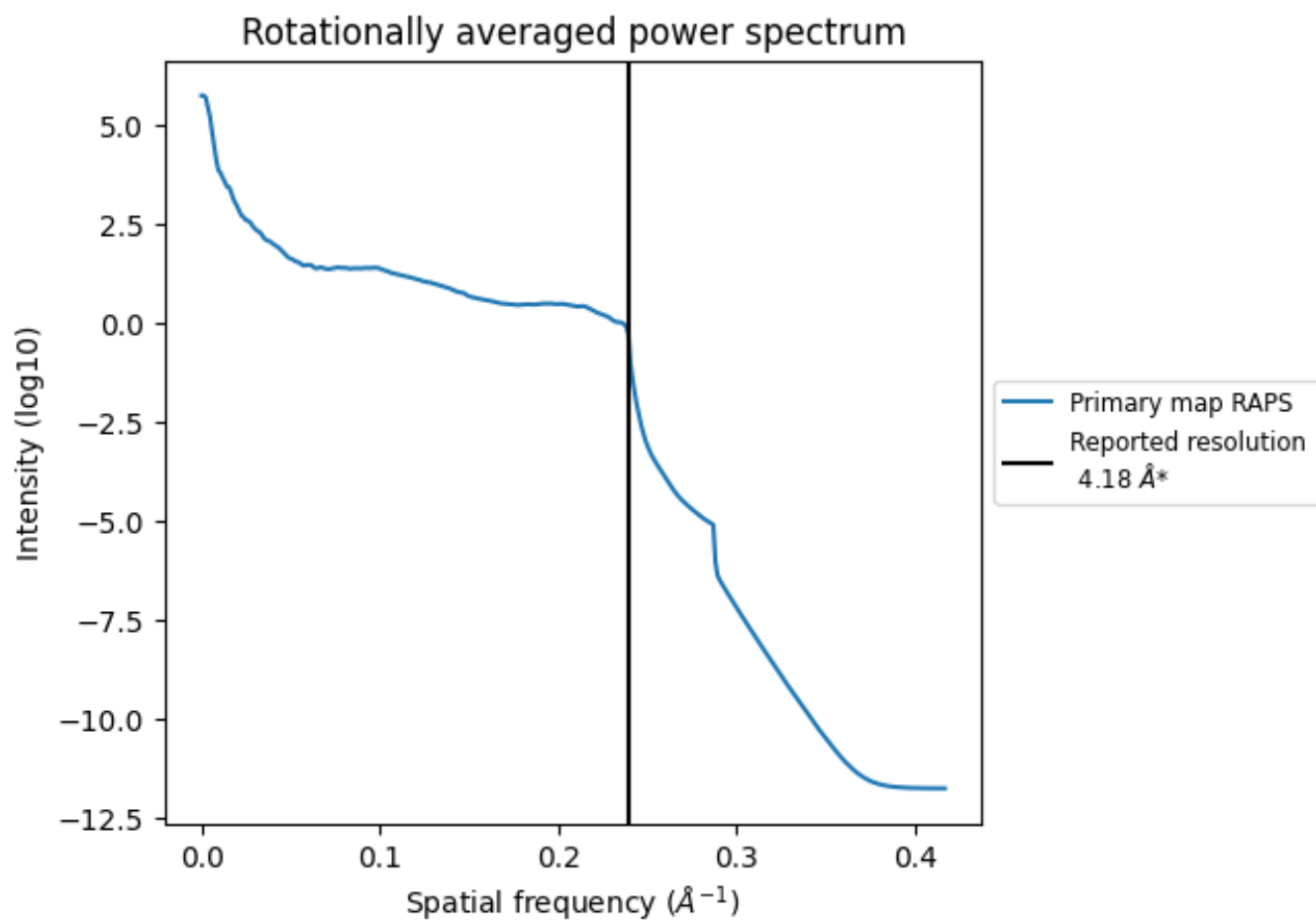

\*Reported resolution corresponds to spatial frequency of  $0.239 \text{\AA}^{-1}$

## 8 Fourier-Shell correlation

This section was not generated. No FSC curve or half-maps provided.

## 9 Map-model fit [i](#)

This section contains information regarding the fit between EMDB map EMD-34403 and PDB model 8GZU. Per-residue inclusion information can be found in section 3 on page 67.

### 9.1 Map-model overlay [i](#)

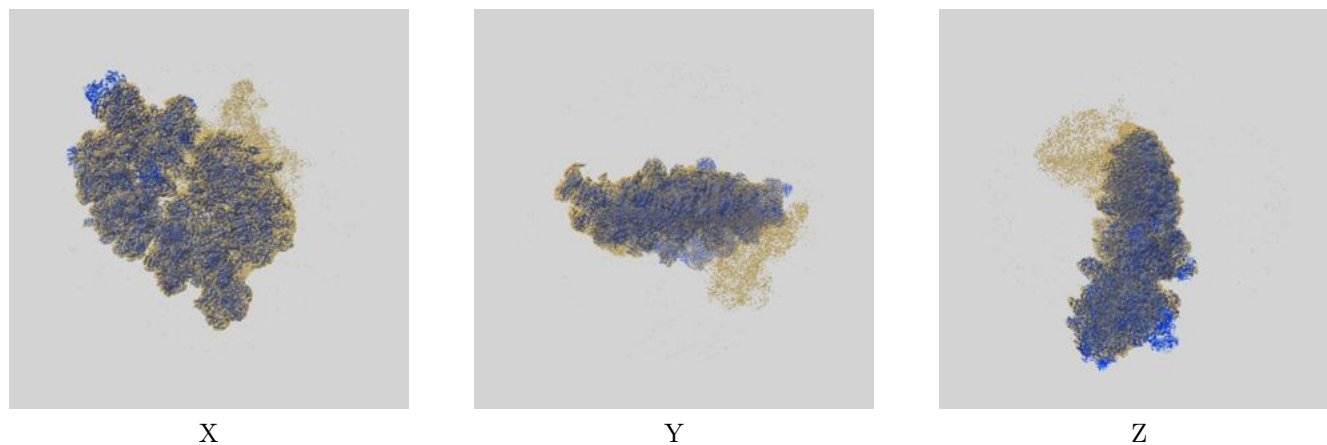

The images above show the 3D surface view of the map at the recommended contour level 4.0 at 50% transparency in yellow overlaid with a ribbon representation of the model coloured in blue. These images allow for the visual assessment of the quality of fit between the atomic model and the map.

## 9.2 Q-score mapped to coordinate model [i](#)

This section was not generated.

## 9.3 Atom inclusion mapped to coordinate model [i](#)

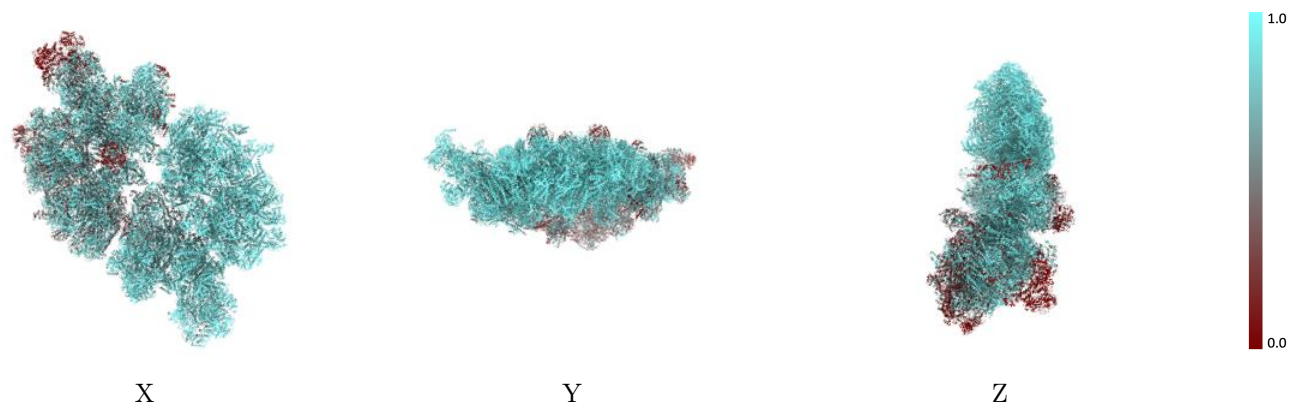

The images above show the model with each residue coloured according to its atom inclusion. This shows to what extent they are inside the map at the recommended contour level (4.0).





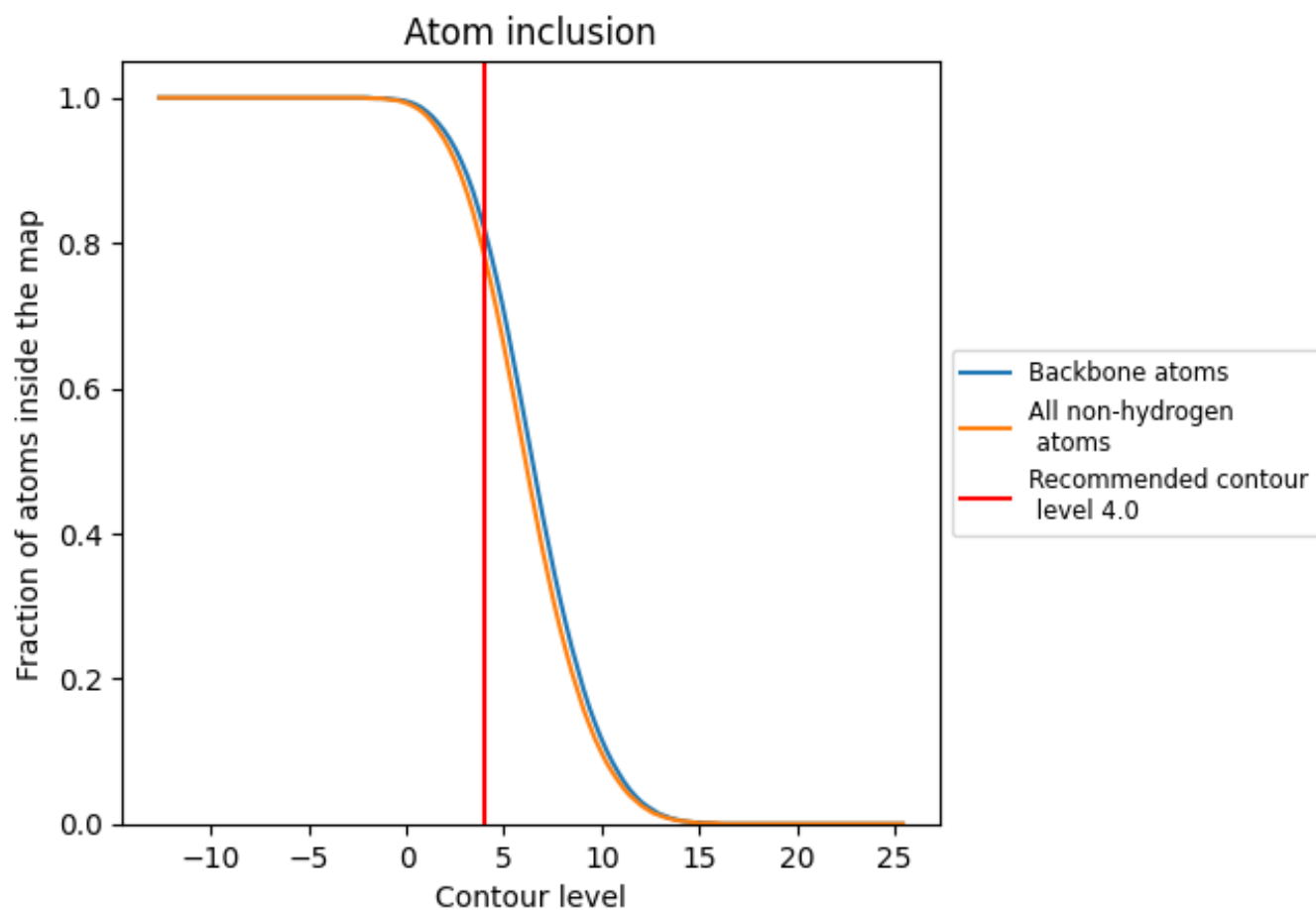































## 9.4 Atom inclusion [i](#)



At the recommended contour level, 82% of all backbone atoms, 78% of all non-hydrogen atoms, are inside the map.

## 9.5 Map-model fit summary











































The table lists the average atom inclusion at the recommended contour level (4.0) and Q-score for the entire model and for each chain.

Chain	Atom inclusion
All	 0.7830
00	 0.7960
01	 0.5440
02	 0.4120
03	 0.3770
04	 0.7010
05	 0.8910
06	 0.7960
07	 0.7370
08	 0.3420
09	 0.7060
0A	 0.6160
0B	 0.1520
0C	 0.7030
0D	 0.6720
0E	 0.7310
0F	 0.6880
0G	 0.6240
0H	 0.7720
0I	 0.5650
0J	 0.5770
10	 0.7310
11	 0.3140
12	 0.6560
13	 0.5870
14	 0.4180
15	 0.7310
16	 0.5840
17	 0.3090
18	 0.3340
19	 0.6290
1B	 0.9490
1T	 0.9430
1b	 0.7540
1t	 0.9690













































*Continued on next page...*

*Continued from previous page...*

Chain	Atom inclusion
20	 0.8420
21	 0.8530
22	 0.5870
23	 0.4980
24	 0.5070
25	 0.1380
26	 0.7100
27	 0.6100
28	 0.6810
29	 0.7220
2B	 0.8550
2E	 0.6230
2F	 0.7960
2G	 0.8680
2H	 0.6730
2I	 0.7570
2J	 0.8670
2K	 0.8550
2L	 0.8580
2M	 0.8030
2N	 0.6850
2O	 0.8190
2T	 0.9430
2b	 0.7870
2e	 0.7520
2f	 0.8150
2g	 0.8550
2h	 0.7650
2i	 0.7160
2j	 0.8850
2k	 0.8140
2l	 0.7610
2m	 0.8950
2n	 0.8480
2o	 0.9240
2t	 0.9710
30	 0.6490
31	 0.5480
32	 0.7500
33	 0.7340
34	 0.6720
35	 0.7220











































*Continued on next page...*

*Continued from previous page...*

Chain	Atom inclusion
36	 0.5870
37	 0.8170
38	 0.7880
39	 0.4530
3T	 0.9540
3t	 0.9900
40	 0.6990
41	 0.4110
42	 0.4600
43	 0.6700
44	 0.5920
45	 0.4480
46	 0.8240
47	 0.8600
48	 0.6800
49	 0.6830
4A	 0.9680
4L	 0.9030
4T	 0.9790
4a	 0.9820
4l	 0.8000
4t	 0.9930
50	 0.3780
51	 0.6910
52	 0.4260
53	 0.3170
54	 0.4000
55	 0.7410
56	 0.7610
57	 0.8430
58	 0.5510
59	 0.7840
5B	 0.8850
5T	 0.9770
5b	 0.8570
5t	 0.9810
60	 0.6850
61	 0.6730
62	 0.2730
63	 0.5890
64	 0.4550
65	 0.6160











































*Continued on next page...*

*Continued from previous page...*

Chain	Atom inclusion
66	 0.6180
67	 0.4700
68	 0.3910
69	 0.4650
6A	 0.9650
6B	 0.9540
6C	 0.9480
6L	 0.9790
6T	 0.9710
6a	 0.9620
6b	 0.9760
6c	 0.9780
6l	 0.9870
6t	 0.9740
70	 0.7720
71	 0.7350
72	 0.6720
73	 0.7530
74	 0.6470
75	 0.2680
76	 0.4240
77	 0.4790
78	 0.7720
79	 0.4160
7A	 0.9580
7C	 0.9400
7L	 0.9570
7a	 0.9790
7c	 0.9870
7l	 0.9800
80	 0.5060
81	 0.4630
82	 0.4180
83	 0.7050
84	 0.7470
85	 0.7390
86	 0.4900
87	 0.7230
88	 0.6530
89	 0.5300
90	 0.3840
91	 0.2540

*Continued on next page...*

*Continued from previous page...*

Chain	Atom inclusion
92	 0.3560
93	 0.2080
94	 0.6070
95	 0.5900
96	 0.4540
97	 0.5350
98	 0.6000
99	 0.4720
A	 0.9780
A1	 0.9310
A2	 0.9610
A3	 0.9150
A5	 0.9180
A6	 0.9600
A7	 0.9460
A8	 0.9560
A9	 0.9540
AB	 0.8990
AC	 0.9690
AL	 0.9480
AM	 0.9240
AN	 0.8150
B	 0.8990
B2	 0.7880
B3	 0.8980
B4	 0.8130
B6	 0.8330
B7	 0.8440
B8	 0.8550
B9	 0.9110
BL	 0.7620
BM	 0.8150
BP	 0.9520
C	 0.9610
C1	 0.9430
C2	 0.9750
C3	 0.9570
C4	 0.8300
D	 0.8770
E	 0.9880
F	 0.9810
FS	 0.9860







































*Continued on next page...*

*Continued from previous page...*

Chain	Atom inclusion
FX	0.9320
G	0.9700
G1	0.9420
G2	0.9500
G3	0.9530
H	0.9220
I	0.9590
J	0.9550
J1	0.9340
K	0.9760
L	0.9430
M	0.9680
M1	0.9490
M2	0.9200
M3	0.9380
N	0.9330
N1	0.8960
N2	0.8920
N3	0.8830
N4	0.8410
N5	0.8140
N6	0.8810
O	0.9770
P	0.9790
P1	0.9090
P2	0.9370
Q	0.9360
QA	0.9710
QB	0.9520
QC	0.8670
QD	0.8840
QE	0.7750
QF	0.8090
QG	0.8940
QH	0.9390
QI	0.9260
QJ	0.8810
QL	0.8500
QM	0.8240
Qa	0.9460
Qb	0.8490
Qc	0.8680

*Continued on next page...*











































*Continued from previous page...*

Chain	Atom inclusion
Qd	 0.8800
Qe	 0.8320
Qf	 0.7030
Qg	 0.9140
Qh	 0.8680
Qi	 0.8890
Qj	 0.8010
Ql	 0.8690
Qm	 0.9060
R	 0.9590
S	 0.9890
S1	 0.8930
S2	 0.9290
S3	 0.9330
S4	 0.7990
S5	 0.7900
S6	 0.9690
S7	 0.9310
S8	 0.9380
SA	 0.5510
SB	 0.7800
SC	 0.7970
SD	 0.8680
T	 0.9390
T1	 0.9240
T2	 0.8210
T3	 0.8850
T4	 0.6570
T5	 0.7210
T6	 0.7420
T7	 0.9400
T8	 0.8140
T9	 0.7420
TA	 0.8850
TB	 0.8740
TC	 0.8890
TD	 0.9420
TE	 0.9230
TF	 0.9130
TG	 0.5500
TH	 0.8070
TX	 0.9360

*Continued on next page...*



*Continued from previous page...*

Chain	Atom inclusion
U	 0.9430
U1	 0.9220
U2	 0.9060
V	 0.9530
V1	 0.8910
V2	 0.8820
VB	 0.9830
W	 0.9850
X	 0.9470
X1	 0.6840
Y	 0.9730
Y0	 0.9710
Y5	 0.9650
Y7	 0.9640
Z	 0.9250
Z1	 0.9140
a	 0.9900
a1	 0.7210
a2	 0.5960
a3	 0.7740
a5	 0.7210
a6	 0.7720
a7	 0.7230
a8	 0.6500
a9	 0.7640
ab	 0.8290
ac	 0.9550
al	 0.7780
am	 0.6750
an	 0.7080
b	 0.9610
b2	 0.8700
b3	 0.9150
b4	 0.8330
b6	 0.8710
b7	 0.8780
b8	 0.8470
b9	 0.8750
bl	 0.8190
bm	 0.8280
bp	 0.9920
c	 0.9680











































*Continued on next page...*

*Continued from previous page...*

Chain	Atom inclusion
c1	0.9620
c2	0.9800
c3	0.9700
c4	0.6920
d	0.9590
e	0.9730
f	0.9950
fs	0.9880
fx	0.8680
g	0.9810
g1	0.8130
g2	0.8730
g3	0.8590
h	0.9780
i	0.9550
j	0.9690
j1	0.8080
k	0.9890
l	0.9490
m	0.9790
m1	0.9840
m2	0.9900
m3	0.9460
n	0.9860
n1	0.7330
n2	0.8270
n3	0.7370
n4	0.8400
n5	0.8220
n6	0.7200
o	0.9880
p	0.9910
p1	0.9070
p2	0.8240
q	0.9730
qA	0.8550
qB	0.8570
qC	0.7790
qD	0.8380
qE	0.8410
qF	0.8000
qG	0.8110

























*Continued on next page...*

*Continued from previous page...*

Chain	Atom inclusion
qH	 0.8240
qI	 0.8840
qJ	 0.8630
qL	 0.8310
qM	 0.7290
qa	 0.8650
qb	 0.6150
qc	 0.8230
qd	 0.7400
qe	 0.6630
qf	 0.1010
qg	 0.7690
qh	 0.7170
qi	 0.6050
qj	 0.7700
ql	 0.8940
qm	 0.4710
r	 0.9410
s	 0.9450
s1	 0.4360
s2	 0.7190
s3	 0.7180
s4	 0.4320
s5	 0.5690
s6	 0.5200
s7	 0.7620
s8	 0.7400
sa	 0.1370
sb	 0.6150
sc	 0.8500
sd	 0.9090
t	 0.9610
t1	 0.6220
t2	 0.0530
t3	 0.7220
t4	 0.7840
t5	 0.8850
t6	 0.5870
t7	 0.6690
t8	 0.7400
t9	 0.6340
ta	 0.8090

*Continued on next page...*

*Continued from previous page...*

Chain	Atom inclusion
tb	 0.8250
tc	 0.6550
td	 0.6880
te	 0.4400
tf	 0.3710
tg	 0.7370
th	 0.7760
tx	 0.8590
u	 0.9780
u1	 0.9000
u2	 0.8240
v	 0.9890
v1	 0.0340
v2	 0.0020
vb	 0.9810
w	 0.9770
x	 0.9850
x1	 0.6840
y	 0.9830
y0	 0.9780
y5	 0.8940
y7	 0.9830
z	 0.8440
z1	 0.9500