



# wwPDB X-ray Structure Validation Summary Report ⓘ

Oct 31, 2023 – 02:37 PM JST

PDB ID : 5GIN  
Title : Crystal structure of box C/D RNP with 12 nt guide regions and 9 nt substrates  
Authors : Yang, Z.; Lin, J.; Ye, K.  
Deposited on : 2016-06-24  
Resolution : 3.31 Å(reported)

This is a wwPDB X-ray Structure Validation Summary Report for a publicly released PDB entry.

We welcome your comments at [validation@mail.wwpdb.org](mailto:validation@mail.wwpdb.org)

A user guide is available at

<https://www.wwpdb.org/validation/2017/XrayValidationReportHelp>

with specific help available everywhere you see the ⓘ symbol.

The types of validation reports are described at

<http://www.wwpdb.org/validation/2017/FAQs#types>.

---

The following versions of software and data (see [references ⓘ](#)) were used in the production of this report:

MolProbity : 4.02b-467  
Mogul : 1.8.5 (274361), CSD as541be (2020)  
Xtriage (Phenix) : 1.13  
EDS : 2.36  
buster-report : 1.1.7 (2018)  
Percentile statistics : 20191225.v01 (using entries in the PDB archive December 25th 2019)  
Refmac : 5.8.0158  
CCP4 : 7.0.044 (Gargrove)  
Ideal geometry (proteins) : Engh & Huber (2001)  
Ideal geometry (DNA, RNA) : Parkinson et al. (1996)  
Validation Pipeline (wwPDB-VP) : 2.36

# 1 Overall quality at a glance

The following experimental techniques were used to determine the structure:

*X-RAY DIFFRACTION*

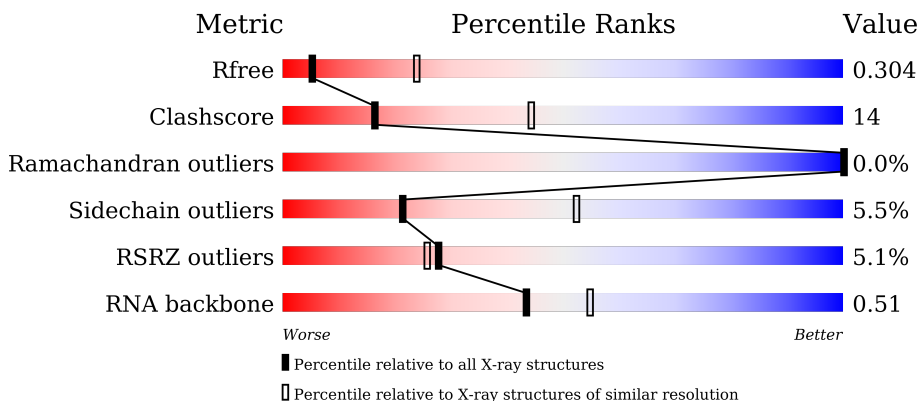

The reported resolution of this entry is 3.31 Å.

Percentile scores (ranging between 0-100) for global validation metrics of the entry are shown in the following graphic. The table shows the number of entries on which the scores are based.





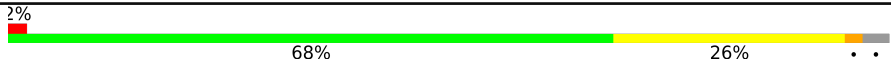
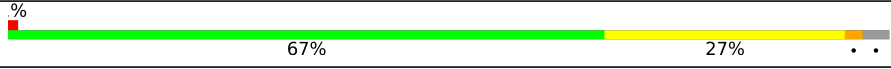





Metric	Whole archive (#Entries)	Similar resolution (#Entries, resolution range(Å))
$R_{free}$	130704	1149 (3.34-3.26)
Clashscore	141614	1205 (3.34-3.26)
Ramachandran outliers	138981	1183 (3.34-3.26)
Sidechain outliers	138945	1182 (3.34-3.26)
RSRZ outliers	127900	1115 (3.34-3.26)
RNA backbone	3102	1117 (3.70-2.90)

The table below summarises the geometric issues observed across the polymeric chains and their fit to the electron density. The red, orange, yellow and green segments of the lower bar indicate the fraction of residues that contain outliers for  $\geq 3$ , 2, 1 and 0 types of geometric quality criteria respectively. A grey segment represents the fraction of residues that are not modelled. The numeric value for each fraction is indicated below the corresponding segment, with a dot representing fractions  $\leq 5\%$ . The upper red bar (where present) indicates the fraction of residues that have poor fit to the electron density. The numeric value is given above the bar.

Mol	Chain	Length	Quality of chain
1	A	388	 2% 68% 26% . .
1	B	388	 % 67% 27% . .
1	K	388	 10% 66% 28% . .
2	C	130	 4% 63% 31% 6%

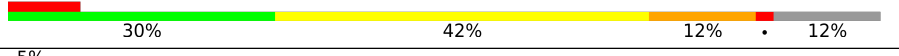
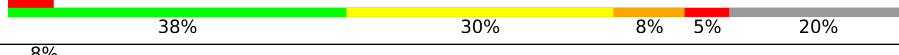
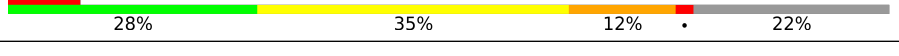
Continued on next page...

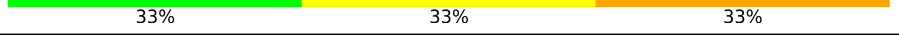
*Continued from previous page...*

Mol	Chain	Length	Quality of chain
2	D	130	 63% 31% 6%
2	L	130	 12% 56% 37% 6%
3	E	232	 61% 33% 6%
3	F	232	 3% 53% 41% 6%
3	M	232	 13% 53% 41% 6%
4	G	40	 8% 30% 42% 12% 12%
4	H	40	 5% 38% 30% 8% 5% 20%
4	N	40	 8% 28% 35% 12% 22%
5	I	9	 44% 44% 11%
5	J	9	 33% 33% 33%
5	O	9	 78% 22%

## 2 Entry composition

There are 6 unique types of molecules in this entry. The entry contains 19986 atoms, of which 0 are hydrogens and 0 are deuteriums.

In the tables below, the ZeroOcc column contains the number of atoms modelled with zero occupancy, the AltConf column contains the number of residues with at least one atom in alternate conformation and the Trace column contains the number of residues modelled with at most 2 atoms.

- Molecule 1 is a protein called C/D box methylation guide ribonucleoprotein complex aNOP56 subunit.

Mol	Chain	Residues	Atoms					ZeroOcc	AltConf	Trace
			Total	C	N	O	S			
1	A	375	2993	1902	528	558	5	0	0	0
1	B	375	2993	1902	528	558	5	0	0	0
1	K	375	2993	1902	528	558	5	0	0	0

There are 33 discrepancies between the modelled and reference sequences:

Chain	Residue	Modelled	Actual	Comment	Reference
A	1	MET	-	initiating methionine	UNP A0A0E3MJI1
A	2	VAL	-	expression tag	UNP A0A0E3MJI1
A	3	LYS	-	expression tag	UNP A0A0E3MJI1
A	381	HIS	-	expression tag	UNP A0A0E3MJI1
A	382	HIS	-	expression tag	UNP A0A0E3MJI1
A	383	HIS	-	expression tag	UNP A0A0E3MJI1
A	384	HIS	-	expression tag	UNP A0A0E3MJI1
A	385	HIS	-	expression tag	UNP A0A0E3MJI1
A	386	HIS	-	expression tag	UNP A0A0E3MJI1
A	387	HIS	-	expression tag	UNP A0A0E3MJI1
A	388	HIS	-	expression tag	UNP A0A0E3MJI1
B	1	MET	-	initiating methionine	UNP A0A0E3MJI1
B	2	VAL	-	expression tag	UNP A0A0E3MJI1
B	3	LYS	-	expression tag	UNP A0A0E3MJI1
B	381	HIS	-	expression tag	UNP A0A0E3MJI1
B	382	HIS	-	expression tag	UNP A0A0E3MJI1
B	383	HIS	-	expression tag	UNP A0A0E3MJI1
B	384	HIS	-	expression tag	UNP A0A0E3MJI1
B	385	HIS	-	expression tag	UNP A0A0E3MJI1
B	386	HIS	-	expression tag	UNP A0A0E3MJI1
B	387	HIS	-	expression tag	UNP A0A0E3MJI1
B	388	HIS	-	expression tag	UNP A0A0E3MJI1

*Continued on next page...*

Continued from previous page...

Chain	Residue	Modelled	Actual	Comment	Reference
K	1	MET	-	initiating methionine	UNP A0A0E3MJ11
K	2	VAL	-	expression tag	UNP A0A0E3MJ11
K	3	LYS	-	expression tag	UNP A0A0E3MJ11
K	381	HIS	-	expression tag	UNP A0A0E3MJ11
K	382	HIS	-	expression tag	UNP A0A0E3MJ11
K	383	HIS	-	expression tag	UNP A0A0E3MJ11
K	384	HIS	-	expression tag	UNP A0A0E3MJ11
K	385	HIS	-	expression tag	UNP A0A0E3MJ11
K	386	HIS	-	expression tag	UNP A0A0E3MJ11
K	387	HIS	-	expression tag	UNP A0A0E3MJ11
K	388	HIS	-	expression tag	UNP A0A0E3MJ11

- Molecule 2 is a protein called 50S ribosomal protein L7Ae.

Mol	Chain	Residues	Atoms					ZeroOcc	AltConf	Trace
			Total	C	N	O	S			
2	C	122	927	588	156	181	2	0	0	0
2	D	122	927	588	156	181	2	0	0	0
2	L	122	927	588	156	181	2	0	0	0

There are 15 discrepancies between the modelled and reference sequences:

Chain	Residue	Modelled	Actual	Comment	Reference
C	1	MET	-	initiating methionine	UNP A0A0E3JZF7
C	2	ASP	-	expression tag	UNP A0A0E3JZF7
C	3	ALA	-	expression tag	UNP A0A0E3JZF7
C	4	MET	-	expression tag	UNP A0A0E3JZF7
C	5	SER	-	expression tag	UNP A0A0E3JZF7
D	1	MET	-	initiating methionine	UNP A0A0E3JZF7
D	2	ASP	-	expression tag	UNP A0A0E3JZF7
D	3	ALA	-	expression tag	UNP A0A0E3JZF7
D	4	MET	-	expression tag	UNP A0A0E3JZF7
D	5	SER	-	expression tag	UNP A0A0E3JZF7
L	1	MET	-	initiating methionine	UNP A0A0E3JZF7
L	2	ASP	-	expression tag	UNP A0A0E3JZF7
L	3	ALA	-	expression tag	UNP A0A0E3JZF7
L	4	MET	-	expression tag	UNP A0A0E3JZF7
L	5	SER	-	expression tag	UNP A0A0E3JZF7

- Molecule 3 is a protein called Fibrillar-like rRNA/tRNA 2'-O-methyltransferase.

Mol	Chain	Residues	Atoms					ZeroOcc	AltConf	Trace
3	E	227	Total	C	N	O	S	0	0	0
			1829	1175	309	341	4			
3	F	227	Total	C	N	O	S	0	0	0
			1829	1175	309	341	4			
3	M	227	Total	C	N	O	S	0	0	0
			1829	1175	309	341	4			

There are 6 discrepancies between the modelled and reference sequences:

Chain	Residue	Modelled	Actual	Comment	Reference
E	1	MET	-	initiating methionine	UNP A0A0E3JUC9
E	2	ALA	-	expression tag	UNP A0A0E3JUC9
F	1	MET	-	initiating methionine	UNP A0A0E3JUC9
F	2	ALA	-	expression tag	UNP A0A0E3JUC9
M	1	MET	-	initiating methionine	UNP A0A0E3JUC9
M	2	ALA	-	expression tag	UNP A0A0E3JUC9

- Molecule 4 is a RNA chain called C/D RNA.

Mol	Chain	Residues	Atoms					ZeroOcc	AltConf	Trace
4	G	35	Total	C	N	O	P	0	0	0
			753	336	138	244	35			
4	H	32	Total	C	N	O	P	0	0	0
			679	304	120	223	32			
4	N	31	Total	C	N	O	P	0	0	0
			659	295	116	217	31			

- Molecule 5 is a RNA chain called substrate.

Mol	Chain	Residues	Atoms					ZeroOcc	AltConf	Trace
5	I	9	Total	C	N	O	P	0	0	0
			190	86	35	61	8			
5	J	9	Total	C	N	O	P	0	0	0
			190	86	35	61	8			
5	O	9	Total	C	N	O	P	0	0	0
			190	86	35	61	8			

- Molecule 6 is S-ADENOSYL-L-HOMOCYSTEINE (three-letter code: SAH) (formula: C<sub>14</sub>H<sub>20</sub>N<sub>6</sub>O<sub>5</sub>S).

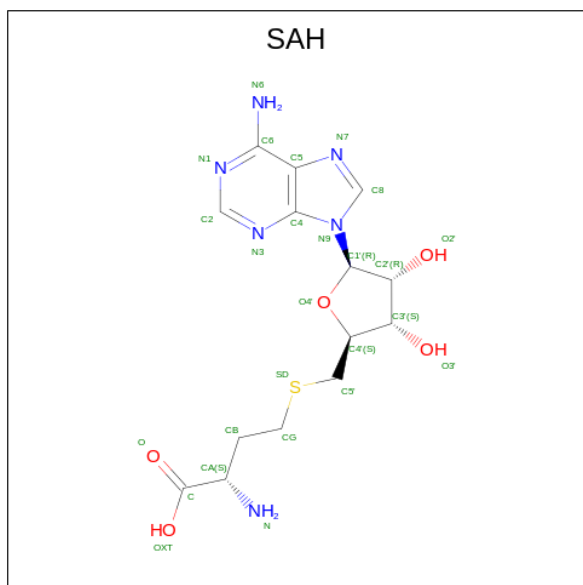

Mol	Chain	Residues	Atoms					ZeroOcc	AltConf
			Total	C	N	O	S		
6	E	1	Total	14	6	5	1	0	0
6	F	1	Total	14	6	5	1	0	0
6	M	1	Total	14	6	5	1	0	0

### 3 Residue-property plots

These plots are drawn for all protein, RNA, DNA and oligosaccharide chains in the entry. The first graphic for a chain summarises the proportions of the various outlier classes displayed in the second graphic. The second graphic shows the sequence view annotated by issues in geometry and electron density. Residues are color-coded according to the number of geometric quality criteria for which they contain at least one outlier: green = 0, yellow = 1, orange = 2 and red = 3 or more. A red dot above a residue indicates a poor fit to the electron density ( $RSRZ > 2$ ). Stretches of 2 or more consecutive residues without any outlier are shown as a green connector. Residues present in the sample, but not in the model, are shown in grey.

- Molecule 1: C/D box methylation guide ribonucleoprotein complex aNOP56 subunit

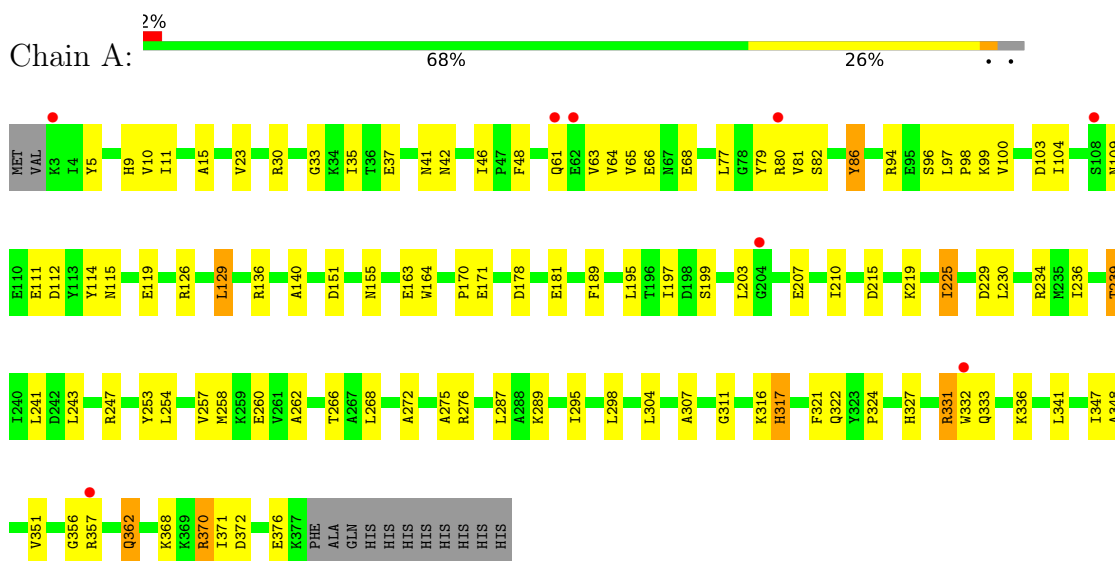

- Molecule 1: C/D box methylation guide ribonucleoprotein complex aNOP56 subunit

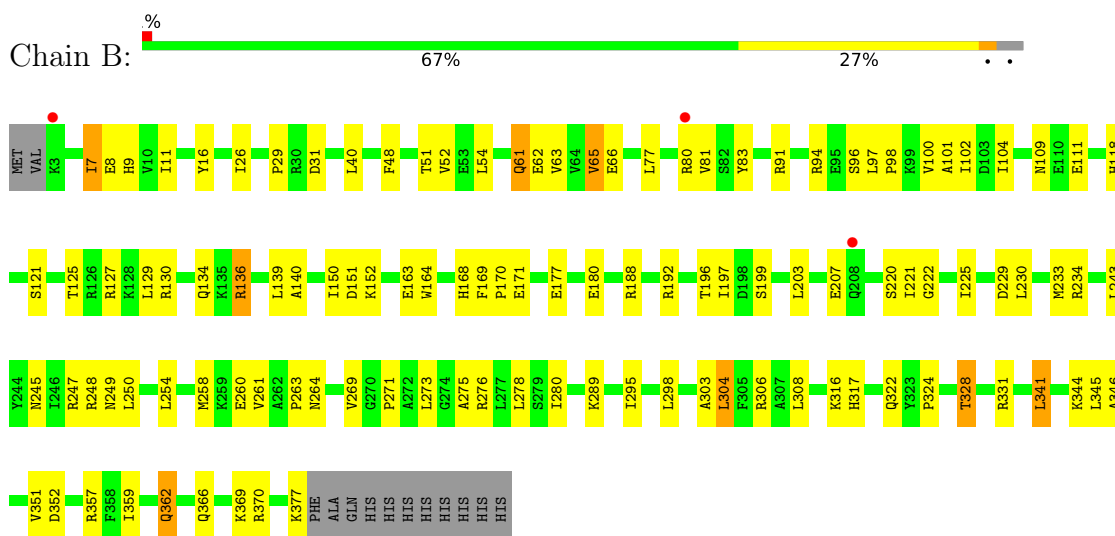

- Molecule 1: C/D box methylation guide ribonucleoprotein complex aNOP56 subunit





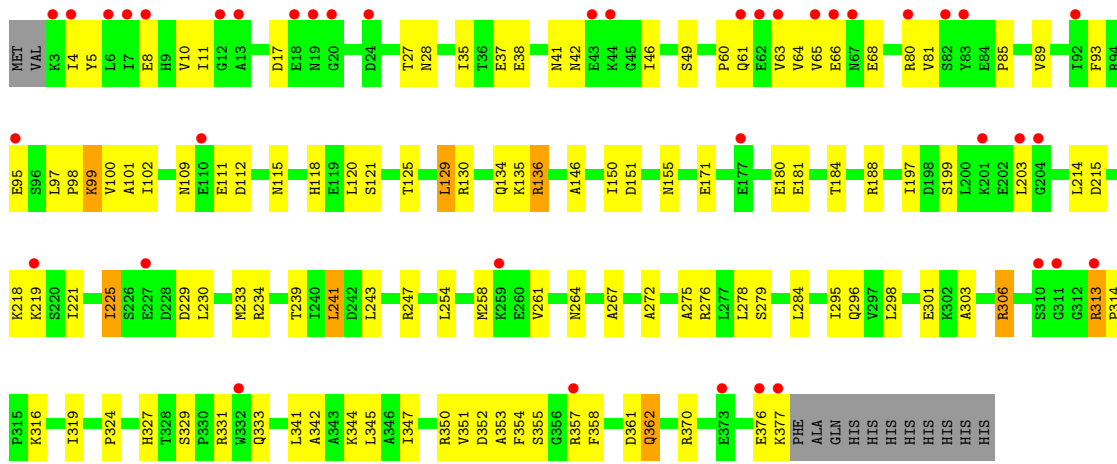

• Molecule 2: 50S ribosomal protein L7Ae



• Molecule 2: 50S ribosomal protein L7Ae

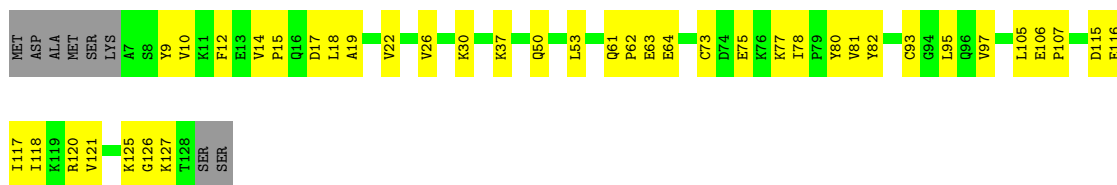

• Molecule 2: 50S ribosomal protein L7Ae

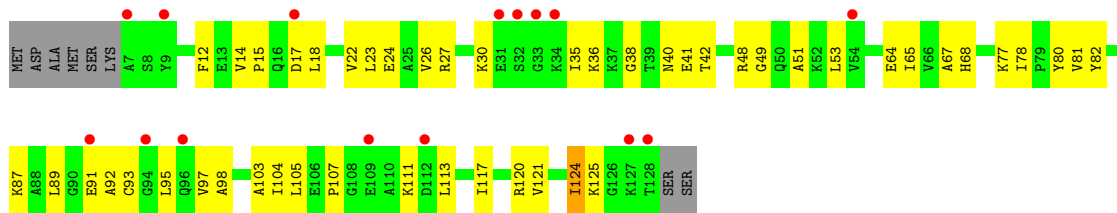

• Molecule 3: Fibrillar-like rRNA/tRNA 2'-O-methyltransferase



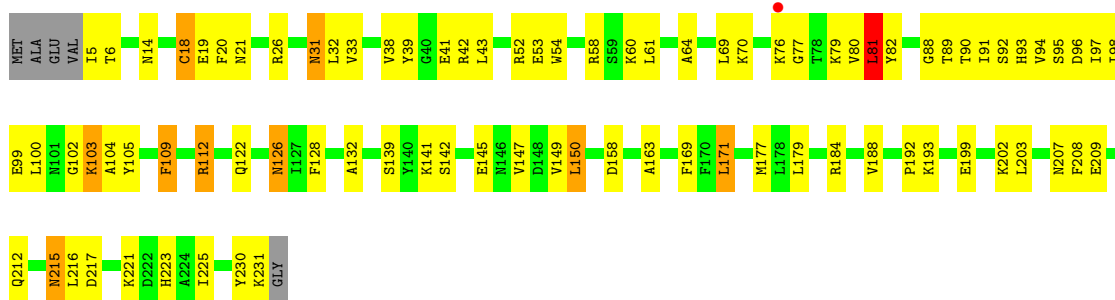

• Molecule 3: Fibrillar-like rRNA/tRNA 2'-O-methyltransferase

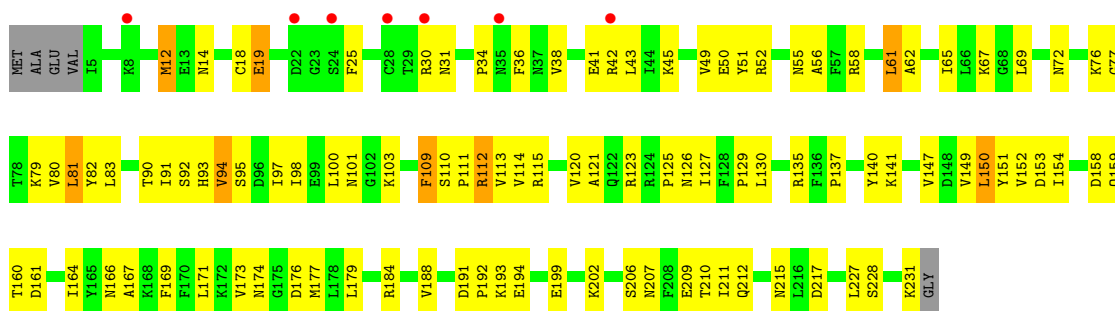

• Molecule 3: Fibrillar-like rRNA/tRNA 2'-O-methyltransferase

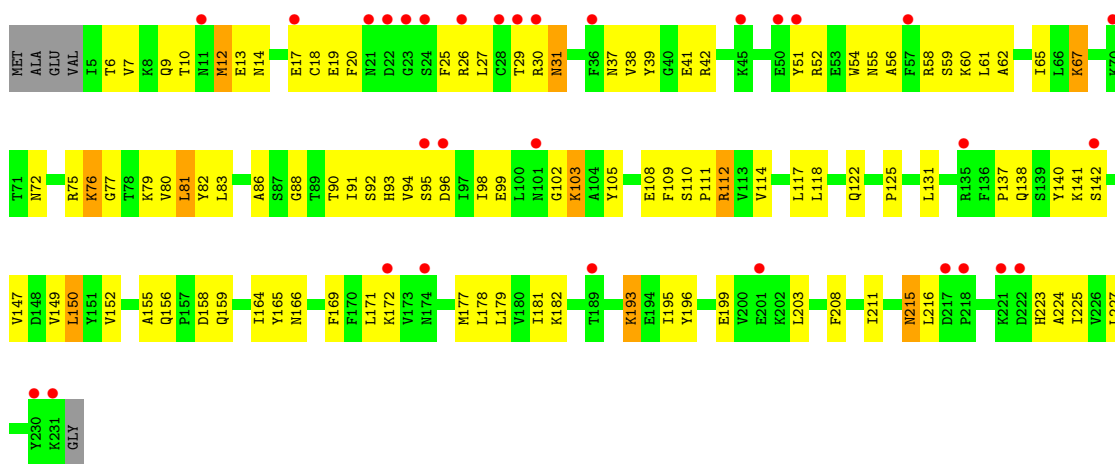

• Molecule 4: C/D RNA

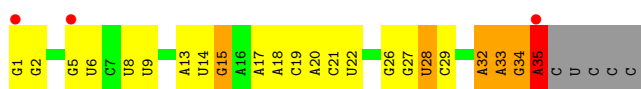

• Molecule 4: C/D RNA



- Molecule 4: C/D RNA

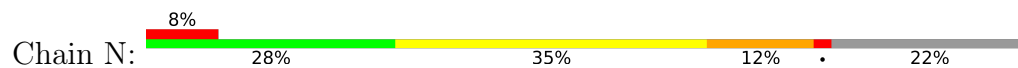

- Molecule 5: substrate



- Molecule 5: substrate



- Molecule 5: substrate

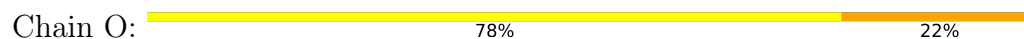

## 4 Data and refinement statistics

Property	Value	Source
Space group	P 41 21 2	Depositor
Cell constants a, b, c, $\alpha$ , $\beta$ , $\gamma$	242.68Å 242.68Å 146.90Å 90.00° 90.00° 90.00°	Depositor
Resolution (Å)	20.00 – 3.31 20.00 – 3.31	Depositor EDS
% Data completeness (in resolution range)	96.1 (20.00-3.31) 96.1 (20.00-3.31)	Depositor EDS
$R_{merge}$	0.13	Depositor
$R_{sym}$	(Not available)	Depositor
$\langle I/\sigma(I) \rangle$ <sup>1</sup>	1.53 (at 3.29Å)	Xtrriage
Refinement program	PHENIX 1.9_1692	Depositor
R, $R_{free}$	0.250 , 0.303 0.253 , 0.304	Depositor DCC
$R_{free}$ test set	3203 reflections (5.10%)	wwPDB-VP
Wilson B-factor (Å <sup>2</sup> )	90.6	Xtrriage
Anisotropy	0.002	Xtrriage
Bulk solvent $k_{sol}$ (e/Å <sup>3</sup> ), $B_{sol}$ (Å <sup>2</sup> )	0.29 , 48.1	EDS
L-test for twinning <sup>2</sup>	$\langle  L  \rangle = 0.50$ , $\langle L^2 \rangle = 0.33$	Xtrriage
Estimated twinning fraction	No twinning to report.	Xtrriage
$F_o, F_c$ correlation	0.90	EDS
Total number of atoms	19986	wwPDB-VP
Average B, all atoms (Å <sup>2</sup> )	91.0	wwPDB-VP

Xtrriage's analysis on translational NCS is as follows: *The largest off-origin peak in the Patterson function is 1.61% of the height of the origin peak. No significant pseudotranslation is detected.*

<sup>1</sup>Intensities estimated from amplitudes.

<sup>2</sup>Theoretical values of  $\langle |L| \rangle$ ,  $\langle L^2 \rangle$  for acentric reflections are 0.5, 0.333 respectively for untwinned datasets, and 0.375, 0.2 for perfectly twinned datasets.

## 5 Model quality i

### 5.1 Standard geometry i

Bond lengths and bond angles in the following residue types are not validated in this section: SAH

The Z score for a bond length (or angle) is the number of standard deviations the observed value is removed from the expected value. A bond length (or angle) with  $|Z| > 5$  is considered an outlier worth inspection. RMSZ is the root-mean-square of all Z scores of the bond lengths (or angles).

Mol	Chain	Bond lengths		Bond angles	
		RMSZ	# Z  >5	RMSZ	# Z  >5
1	A	0.63	0/3043	0.84	0/4106
1	B	0.63	0/3043	0.83	1/4106 (0.0%)
1	K	0.58	0/3043	0.82	5/4106 (0.1%)
2	C	0.63	0/936	0.86	0/1260
2	D	0.64	0/936	0.80	0/1260
2	L	0.62	0/936	0.83	0/1260
3	E	0.70	2/1863 (0.1%)	0.90	2/2521 (0.1%)
3	F	0.61	0/1863	0.83	0/2521
3	M	0.58	0/1863	0.77	0/2521
4	G	0.90	1/843 (0.1%)	1.63	18/1313 (1.4%)
4	H	0.76	0/758	1.50	8/1178 (0.7%)
4	N	1.20	6/736 (0.8%)	2.01	44/1144 (3.8%)
5	I	0.99	0/212	1.74	3/329 (0.9%)
5	J	1.04	1/212 (0.5%)	2.14	7/329 (2.1%)
5	O	0.91	0/212	2.01	13/329 (4.0%)
All	All	0.68	10/20499 (0.0%)	1.05	101/28283 (0.4%)

The worst 5 of 10 bond length outliers are listed below:

Mol	Chain	Res	Type	Atoms	Z	Observed(Å)	Ideal(Å)
4	G	35	A	N9-C4	7.43	1.42	1.37
3	E	18	CYS	CB-SG	-7.19	1.70	1.82
4	N	11	U	C4-O4	-7.10	1.18	1.23
5	J	3	A	N9-C4	-6.47	1.33	1.37
4	N	17	A	N9-C8	6.36	1.42	1.37

The worst 5 of 101 bond angle outliers are listed below:

Mol	Chain	Res	Type	Atoms	Z	Observed(°)	Ideal(°)
5	J	2	C	C6-N1-C2	-12.88	115.15	120.30

*Continued on next page...*

Continued from previous page...

Mol	Chain	Res	Type	Atoms	Z	Observed(°)	Ideal(°)
5	O	8	U	C6-N1-C2	-12.00	113.80	121.00
5	J	2	C	N3-C4-C5	-10.13	117.85	121.90
5	O	8	U	N3-C4-C5	-9.92	108.65	114.60
4	G	35	A	C8-N9-C4	-9.70	101.92	105.80

There are no chirality outliers.

There are no planarity outliers.

## 5.2 Too-close contacts

In the following table, the Non-H and H(model) columns list the number of non-hydrogen atoms and hydrogen atoms in the chain respectively. The H(added) column lists the number of hydrogen atoms added and optimized by MolProbity. The Clashes column lists the number of clashes within the asymmetric unit, whereas Symm-Clashes lists symmetry-related clashes.

Mol	Chain	Non-H	H(model)	H(added)	Clashes	Symm-Clashes
1	A	2993	0	3055	88	0
1	B	2993	0	3055	82	0
1	K	2993	0	3055	86	1
2	C	927	0	981	27	0
2	D	927	0	981	25	0
2	L	927	0	981	32	0
3	E	1829	0	1862	78	0
3	F	1829	0	1862	73	0
3	M	1829	0	1862	82	0
4	G	753	0	377	10	0
4	H	679	0	345	8	0
4	N	659	0	333	8	0
5	I	190	0	99	2	0
5	J	190	0	99	4	0
5	O	190	0	99	5	1
6	E	26	0	19	0	0
6	F	26	0	19	2	0
6	M	26	0	19	1	0
All	All	19986	0	19103	549	1

The all-atom clashscore is defined as the number of clashes found per 1000 atoms (including hydrogen atoms). The all-atom clashscore for this structure is 14.

The worst 5 of 549 close contacts within the same asymmetric unit are listed below, sorted by their clash magnitude.

Atom-1	Atom-2	Interatomic distance (Å)	Clash overlap (Å)
1:K:303:ALA:HA	1:K:306:ARG:HH22	1.26	1.01
3:M:14:ASN:HD21	3:M:76:LYS:HE3	1.28	0.99
3:E:112:ARG:NH2	1:B:163:GLU:OE1	1.96	0.97
3:F:14:ASN:HD21	3:F:76:LYS:HE3	1.30	0.94
3:M:83:LEU:HD12	3:M:152:VAL:HG22	1.53	0.90

All (1) symmetry-related close contacts are listed below. The label for Atom-2 includes the symmetry operator and encoded unit-cell translations to be applied.

Atom-1	Atom-2	Interatomic distance (Å)	Clash overlap (Å)
5:O:8:U:O2'	1:K:155:ASN:ND2[7_645]	2.18	0.02

### 5.3 Torsion angles [i](#)

#### 5.3.1 Protein backbone [i](#)

In the following table, the Percentiles column shows the percent Ramachandran outliers of the chain as a percentile score with respect to all X-ray entries followed by that with respect to entries of similar resolution.

The Analysed column shows the number of residues for which the backbone conformation was analysed, and the total number of residues.

Mol	Chain	Analysed	Favoured	Allowed	Outliers	Percentiles	
1	A	373/388 (96%)	361 (97%)	12 (3%)	0	100	100
1	B	373/388 (96%)	357 (96%)	16 (4%)	0	100	100
1	K	373/388 (96%)	358 (96%)	14 (4%)	1 (0%)	41	71
2	C	120/130 (92%)	120 (100%)	0	0	100	100
2	D	120/130 (92%)	117 (98%)	3 (2%)	0	100	100
2	L	120/130 (92%)	118 (98%)	2 (2%)	0	100	100
3	E	225/232 (97%)	210 (93%)	15 (7%)	0	100	100
3	F	225/232 (97%)	209 (93%)	16 (7%)	0	100	100
3	M	225/232 (97%)	209 (93%)	16 (7%)	0	100	100
All	All	2154/2250 (96%)	2059 (96%)	94 (4%)	1 (0%)	100	100

All (1) Ramachandran outliers are listed below:

Mol	Chain	Res	Type
1	K	85	PRO

### 5.3.2 Protein sidechains [i](#)

In the following table, the Percentiles column shows the percent sidechain outliers of the chain as a percentile score with respect to all X-ray entries followed by that with respect to entries of similar resolution.

The Analysed column shows the number of residues for which the sidechain conformation was analysed, and the total number of residues.

Mol	Chain	Analysed	Rotameric	Outliers	Percentiles	
1	A	318/330 (96%)	303 (95%)	15 (5%)	26	57
1	B	318/330 (96%)	298 (94%)	20 (6%)	18	47
1	K	318/330 (96%)	307 (96%)	11 (4%)	36	64
2	C	100/107 (94%)	97 (97%)	3 (3%)	41	68
2	D	100/107 (94%)	96 (96%)	4 (4%)	31	61
2	L	100/107 (94%)	96 (96%)	4 (4%)	31	61
3	E	202/205 (98%)	187 (93%)	15 (7%)	13	40
3	F	202/205 (98%)	188 (93%)	14 (7%)	15	44
3	M	202/205 (98%)	186 (92%)	16 (8%)	12	37
All	All	1860/1926 (97%)	1758 (94%)	102 (6%)	21	52

5 of 102 residues with a non-rotameric sidechain are listed below:

Mol	Chain	Res	Type
3	F	12	MET
1	K	8	GLU
3	M	179	LEU
3	F	42	ARG
3	F	112	ARG

Sometimes sidechains can be flipped to improve hydrogen bonding and reduce clashes. 5 of 43 such sidechains are listed below:

Mol	Chain	Res	Type
3	F	126	ASN
1	K	362	GLN
3	F	174	ASN
1	K	61	GLN

*Continued on next page...*



*Continued from previous page...*

Mol	Chain	Res	Type
3	M	9	GLN

### 5.3.3 RNA [i](#)

Mol	Chain	Analysed	Backbone Outliers	Pucker Outliers
4	G	34/40 (85%)	8 (23%)	1 (2%)
4	H	31/40 (77%)	9 (29%)	0
4	N	31/40 (77%)	6 (19%)	1 (3%)
5	I	8/9 (88%)	0	0
5	J	8/9 (88%)	0	0
5	O	8/9 (88%)	0	0
All	All	120/147 (81%)	23 (19%)	2 (1%)

5 of 23 RNA backbone outliers are listed below:

Mol	Chain	Res	Type
4	G	5	G
4	G	6	U
4	G	18	A
4	G	28	U
4	G	29	C

All (2) RNA pucker outliers are listed below:

Mol	Chain	Res	Type
4	G	5	G
4	N	6	U

## 5.4 Non-standard residues in protein, DNA, RNA chains [i](#)

There are no non-standard protein/DNA/RNA residues in this entry.

## 5.5 Carbohydrates [i](#)

There are no monosaccharides in this entry.

## 5.6 Ligand geometry [i](#)

3 ligands are modelled in this entry.

In the following table, the Counts columns list the number of bonds (or angles) for which Mogul statistics could be retrieved, the number of bonds (or angles) that are observed in the model and the number of bonds (or angles) that are defined in the Chemical Component Dictionary. The Link column lists molecule types, if any, to which the group is linked. The Z score for a bond length (or angle) is the number of standard deviations the observed value is removed from the expected value. A bond length (or angle) with  $|Z| > 2$  is considered an outlier worth inspection. RMSZ is the root-mean-square of all Z scores of the bond lengths (or angles).

Mol	Type	Chain	Res	Link	Bond lengths			Bond angles		
					Counts	RMSZ	# Z  > 2	Counts	RMSZ	# Z  > 2
6	SAH	E	301	-	24,28,28	1.35	3 (12%)	25,40,40	1.85	3 (12%)
6	SAH	M	301	-	24,28,28	1.26	3 (12%)	25,40,40	1.91	5 (20%)
6	SAH	F	301	-	24,28,28	1.20	3 (12%)	25,40,40	1.95	7 (28%)

In the following table, the Chirals column lists the number of chiral outliers, the number of chiral centers analysed, the number of these observed in the model and the number defined in the Chemical Component Dictionary. Similar counts are reported in the Torsion and Rings columns. '-' means no outliers of that kind were identified.

Mol	Type	Chain	Res	Link	Chirals	Torsions	Rings
6	SAH	E	301	-	-	4/11/31/31	0/3/3/3
6	SAH	M	301	-	-	1/11/31/31	0/3/3/3
6	SAH	F	301	-	-	3/11/31/31	0/3/3/3

The worst 5 of 9 bond length outliers are listed below:

Mol	Chain	Res	Type	Atoms	Z	Observed(Å)	Ideal(Å)
6	M	301	SAH	C2-N3	4.32	1.39	1.32
6	F	301	SAH	C2-N3	4.28	1.39	1.32
6	E	301	SAH	C2-N3	4.07	1.38	1.32
6	E	301	SAH	C2-N1	2.89	1.39	1.33
6	M	301	SAH	C2-N1	2.47	1.38	1.33

The worst 5 of 15 bond angle outliers are listed below:

Mol	Chain	Res	Type	Atoms	Z	Observed(°)	Ideal(°)
6	E	301	SAH	N3-C2-N1	-6.01	119.28	128.68
6	M	301	SAH	N3-C2-N1	-5.58	119.96	128.68
6	F	301	SAH	N3-C2-N1	-5.13	120.66	128.68
6	M	301	SAH	C5'-SD-CG	-4.86	87.70	102.27
6	F	301	SAH	C5'-SD-CG	-4.51	88.74	102.27

There are no chirality outliers.

5 of 8 torsion outliers are listed below:

Mol	Chain	Res	Type	Atoms
6	F	301	SAH	N-CA-CB-CG
6	F	301	SAH	C-CA-CB-CG
6	M	301	SAH	N-CA-CB-CG
6	E	301	SAH	OXT-C-CA-N
6	E	301	SAH	O-C-CA-N

There are no ring outliers.

2 monomers are involved in 3 short contacts:

Mol	Chain	Res	Type	Clashes	Symm-Clashes
6	M	301	SAH	1	0
6	F	301	SAH	2	0

The following is a two-dimensional graphical depiction of Mogul quality analysis of bond lengths, bond angles, torsion angles, and ring geometry for all instances of the Ligand of Interest. In addition, ligands with molecular weight > 250 and outliers as shown on the validation Tables will also be included. For torsion angles, if less than 5% of the Mogul distribution of torsion angles is within 10 degrees of the torsion angle in question, then that torsion angle is considered an outlier. Any bond that is central to one or more torsion angles identified as an outlier by Mogul will be highlighted in the graph. For rings, the root-mean-square deviation (RMSD) between the ring in question and similar rings identified by Mogul is calculated over all ring torsion angles. If the average RMSD is greater than 60 degrees and the minimal RMSD between the ring in question and any Mogul-identified rings is also greater than 60 degrees, then that ring is considered an outlier. The outliers are highlighted in purple. The color gray indicates Mogul did not find sufficient equivalents in the CSD to analyse the geometry.

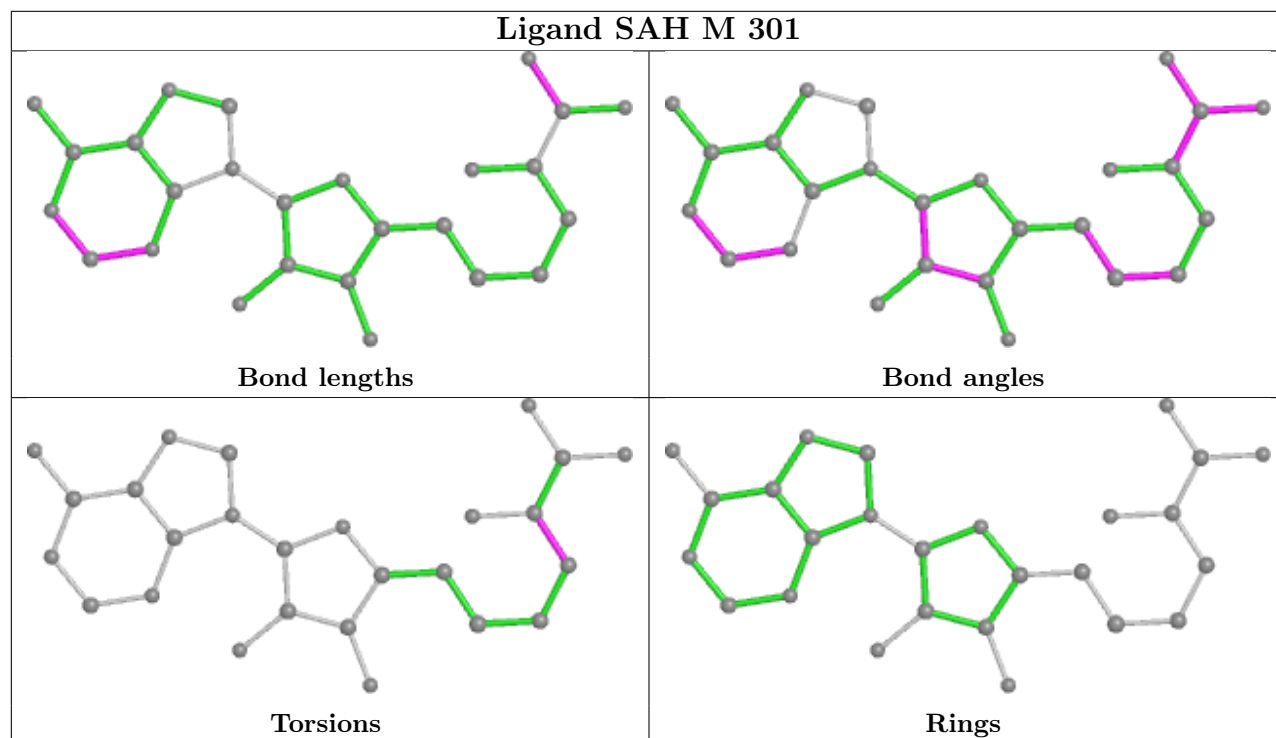
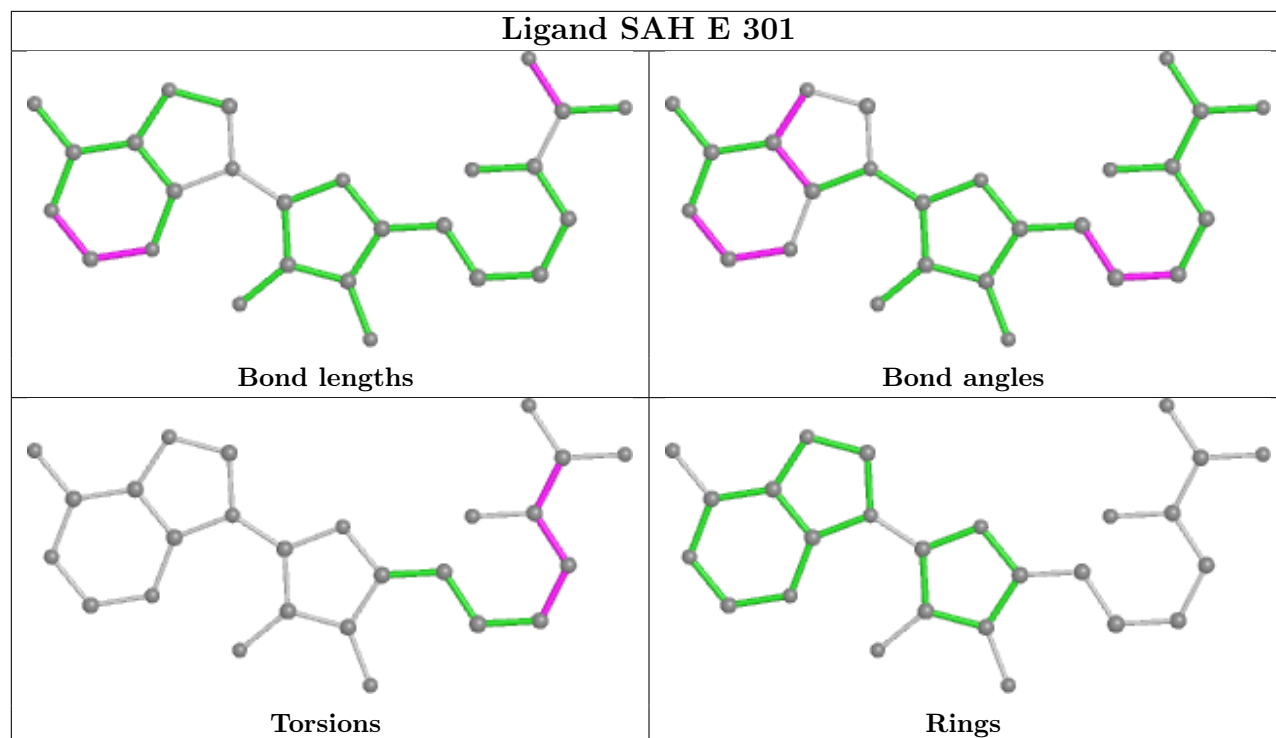

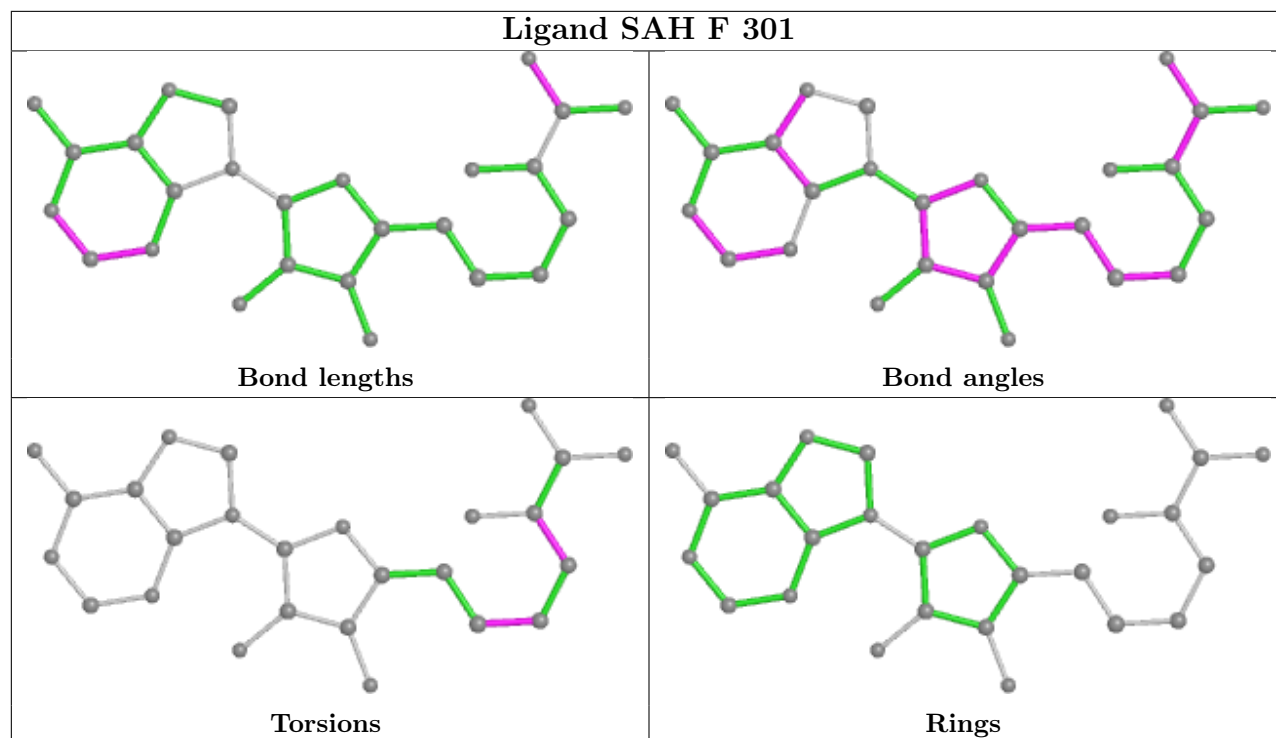

## 5.7 Other polymers [i](#)

There are no such residues in this entry.

## 5.8 Polymer linkage issues [i](#)

There are no chain breaks in this entry.

## 6 Fit of model and data [i](#)

### 6.1 Protein, DNA and RNA chains [i](#)

In the following table, the column labelled ‘#RSRZ> 2’ contains the number (and percentage) of RSRZ outliers, followed by percent RSRZ outliers for the chain as percentile scores relative to all X-ray entries and entries of similar resolution. The OWAB column contains the minimum, median, 95<sup>th</sup> percentile and maximum values of the occupancy-weighted average B-factor per residue. The column labelled ‘Q< 0.9’ lists the number of (and percentage) of residues with an average occupancy less than 0.9.

Mol	Chain	Analysed	<RSRZ>	#RSRZ>2	OWAB(Å <sup>2</sup> )	Q<0.9
1	A	375/388 (96%)	-0.18	8 (2%) 63 62	37, 78, 110, 126	0
1	B	375/388 (96%)	-0.21	3 (0%) 86 86	43, 76, 113, 128	0
1	K	375/388 (96%)	0.42	40 (10%) 6 5	72, 108, 137, 151	0
2	C	122/130 (93%)	0.33	5 (4%) 37 35	71, 108, 125, 135	0
2	D	122/130 (93%)	-0.10	0 100 100	59, 83, 107, 115	0
2	L	122/130 (93%)	0.81	15 (12%) 4 3	99, 129, 143, 150	0
3	E	227/232 (97%)	-0.34	1 (0%) 92 93	42, 62, 90, 106	0
3	F	227/232 (97%)	0.01	7 (3%) 49 48	54, 78, 107, 117	0
3	M	227/232 (97%)	0.83	31 (13%) 3 2	92, 120, 132, 143	0
4	G	35/40 (87%)	0.23	3 (8%) 10 10	47, 65, 128, 140	0
4	H	32/40 (80%)	0.06	2 (6%) 20 20	50, 72, 114, 122	0
4	N	31/40 (77%)	0.81	3 (9%) 7 8	85, 120, 151, 165	0
5	I	9/9 (100%)	-0.09	0 100 100	49, 52, 60, 64	0
5	J	9/9 (100%)	-0.26	0 100 100	56, 61, 71, 72	0
5	O	9/9 (100%)	0.44	0 100 100	99, 106, 117, 120	0
All	All	2297/2397 (95%)	0.13	118 (5%) 28 26	37, 90, 132, 165	0

The worst 5 of 118 RSRZ outliers are listed below:

Mol	Chain	Res	Type	RSRZ
1	K	3	LYS	5.9
1	K	18	GLU	5.4
2	L	96	GLN	5.0
3	M	189	THR	5.0
4	G	1	G	4.6

## 6.2 Non-standard residues in protein, DNA, RNA chains [i](#)

There are no non-standard protein/DNA/RNA residues in this entry.

## 6.3 Carbohydrates [i](#)

There are no monosaccharides in this entry.

## 6.4 Ligands [i](#)

In the following table, the Atoms column lists the number of modelled atoms in the group and the number defined in the chemical component dictionary. The B-factors column lists the minimum, median, 95<sup>th</sup> percentile and maximum values of B factors of atoms in the group. The column labelled 'Q< 0.9' lists the number of atoms with occupancy less than 0.9.

Mol	Type	Chain	Res	Atoms	RSCC	RSR	B-factors(Å <sup>2</sup> )	Q<0.9
6	SAH	M	301	26/26	0.76	0.32	99,110,123,128	0
6	SAH	F	301	26/26	0.90	0.27	55,68,81,86	0
6	SAH	E	301	26/26	0.92	0.23	55,65,81,97	0

The following is a graphical depiction of the model fit to experimental electron density of all instances of the Ligand of Interest. In addition, ligands with molecular weight > 250 and outliers as shown on the geometry validation Tables will also be included. Each fit is shown from different orientation to approximate a three-dimensional view.

**Electron density around SAH M 301:**

$2mF_o-DF_c$  (at 0.7 rmsd) in gray  
 $mF_o-DF_c$  (at 3 rmsd) in purple (negative)  
and green (positive)

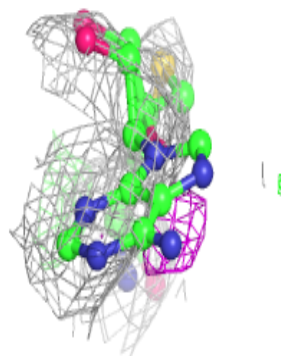
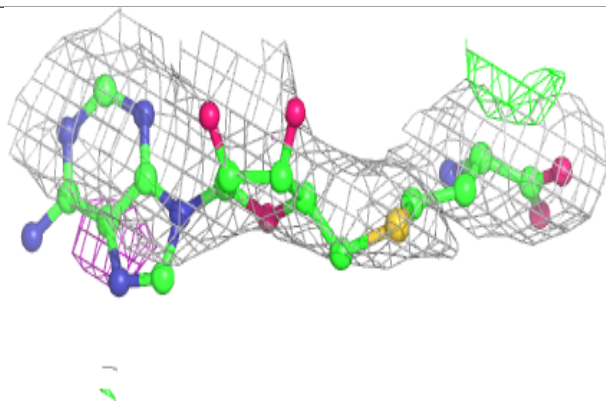
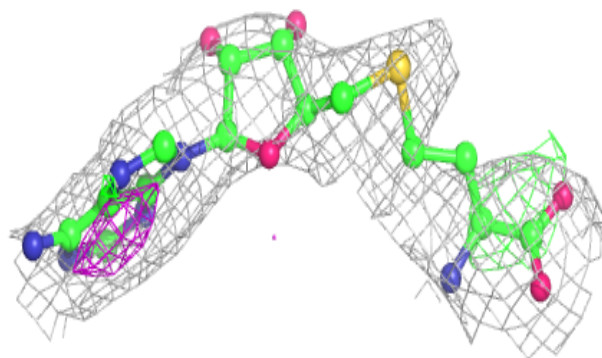
**Electron density around SAH F 301:**

$2mF_o-DF_c$  (at 0.7 rmsd) in gray  
 $mF_o-DF_c$  (at 3 rmsd) in purple (negative)  
and green (positive)

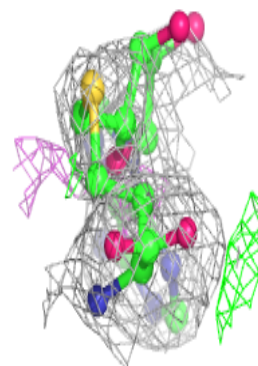
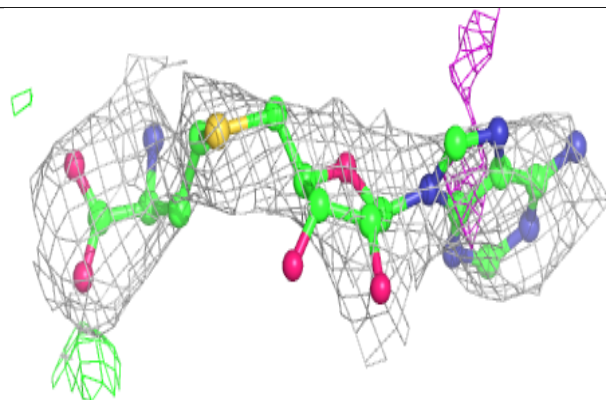
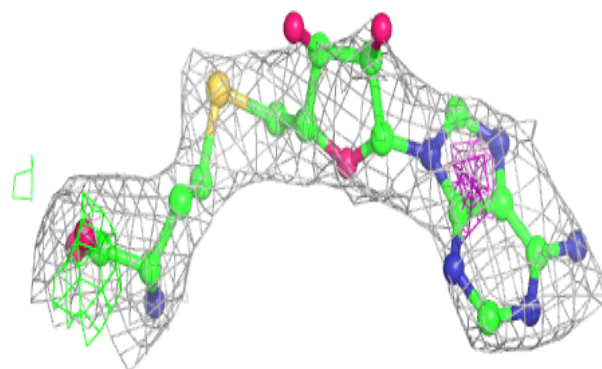



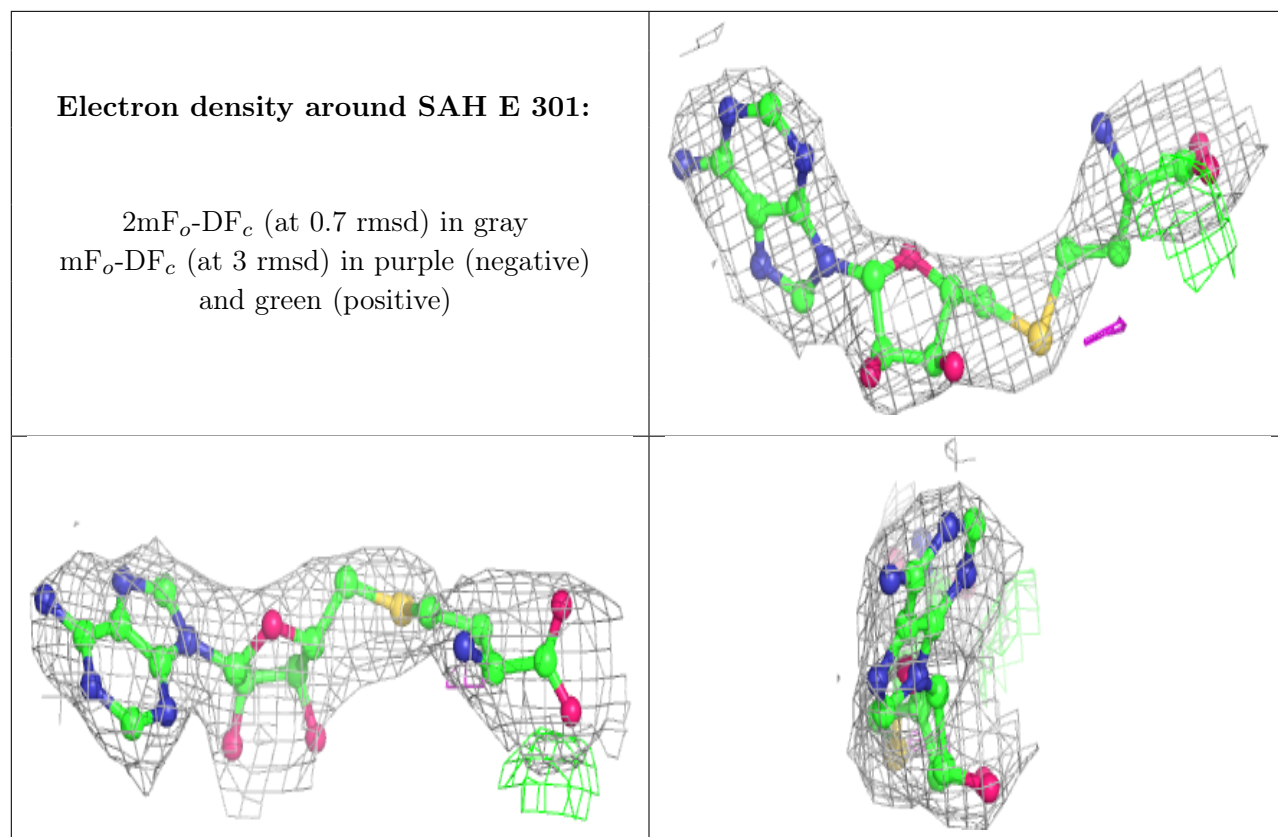

## 6.5 Other polymers [i](#)

There are no such residues in this entry.