



# wwPDB X-ray Structure Validation Summary Report ⓘ

Nov 21, 2023 – 07:02 AM JST

PDB ID : 7F6U  
Title : Crystal structure of metal-citrate-binding mutant (Y221A) protein (MctA) of ABC transporter in apo state  
Authors : Kanaujia, S.P.; Mandal, S.K.  
Deposited on : 2021-06-25  
Resolution : 1.75 Å(reported)

This is a wwPDB X-ray Structure Validation Summary Report for a publicly released PDB entry.

We welcome your comments at [validation@mail.wwpdb.org](mailto:validation@mail.wwpdb.org)

A user guide is available at

<https://www.wwpdb.org/validation/2017/XrayValidationReportHelp>

with specific help available everywhere you see the ⓘ symbol.

The types of validation reports are described at

<http://www.wwpdb.org/validation/2017/FAQs#types>.

---

The following versions of software and data (see [references ⓘ](#)) were used in the production of this report:

MolProbity : 4.02b-467  
Mogul : 1.8.5 (274361), CSD as541be (2020)  
Xtriage (Phenix) : 1.13  
EDS : 2.36  
Percentile statistics : 20191225.v01 (using entries in the PDB archive December 25th 2019)  
Refmac : 5.8.0158  
CCP4 : 7.0.044 (Gargrove)  
Ideal geometry (proteins) : Engh & Huber (2001)  
Ideal geometry (DNA, RNA) : Parkinson et al. (1996)  
Validation Pipeline (wwPDB-VP) : 2.36

# 1 Overall quality at a glance

The following experimental techniques were used to determine the structure:

*X-RAY DIFFRACTION*

The reported resolution of this entry is 1.75 Å.

Percentile scores (ranging between 0-100) for global validation metrics of the entry are shown in the following graphic. The table shows the number of entries on which the scores are based.

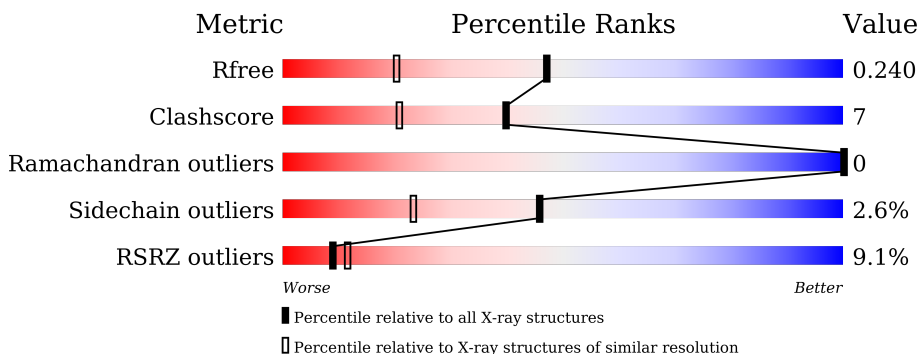

Metric	Whole archive (#Entries)	Similar resolution (#Entries, resolution range(Å))
$R_{free}$	130704	2340 (1.76-1.76)
Clashscore	141614	2466 (1.76-1.76)
Ramachandran outliers	138981	2437 (1.76-1.76)
Sidechain outliers	138945	2437 (1.76-1.76)
RSRZ outliers	127900	2298 (1.76-1.76)

The table below summarises the geometric issues observed across the polymeric chains and their fit to the electron density. The red, orange, yellow and green segments of the lower bar indicate the fraction of residues that contain outliers for  $\geq 3$ , 2, 1 and 0 types of geometric quality criteria respectively. A grey segment represents the fraction of residues that are not modelled. The numeric value for each fraction is indicated below the corresponding segment, with a dot representing fractions  $\leq 5\%$ . The upper red bar (where present) indicates the fraction of residues that have poor fit to the electron density. The numeric value is given above the bar.

Mol	Chain	Length	Quality of chain
1	A	342	

The following table lists non-polymeric compounds, carbohydrate monomers and non-standard residues in protein, DNA, RNA chains that are outliers for geometric or electron-density-fit criteria:

Mol	Type	Chain	Res	Chirality	Geometry	Clashes	Electron density
5	EDO	A	408	-	-	X	-
7	BGQ	A	410	-	-	X	-

## 2 Entry composition

There are 10 unique types of molecules in this entry. The entry contains 3028 atoms, of which 0 are hydrogens and 0 are deuteriums.

In the tables below, the ZeroOcc column contains the number of atoms modelled with zero occupancy, the AltConf column contains the number of residues with at least one atom in alternate conformation and the Trace column contains the number of residues modelled with at most 2 atoms.

- Molecule 1 is a protein called Iron ABC transporter, periplasmic iron-binding protein.

Mol	Chain	Residues	Atoms					ZeroOcc	AltConf	Trace
			Total	C	N	O	S			
1	A	339	2694	1724	469	496	5	0	5	0

There are 3 discrepancies between the modelled and reference sequences:

Chain	Residue	Modelled	Actual	Comment	Reference
A	-1	MET	-	initiating methionine	UNP Q53VZ2
A	0	MET	-	expression tag	UNP Q53VZ2
A	221	ALA	TYR	engineered mutation	UNP Q53VZ2

- Molecule 2 is SODIUM ION (three-letter code: NA) (formula: Na).

Mol	Chain	Residues	Atoms		ZeroOcc	AltConf
2	A	2	Total	Na	0	0
			2	2		

- Molecule 3 is SULFATE ION (three-letter code: SO4) (formula: O<sub>4</sub>S).



Mol	Chain	Residues	Atoms			ZeroOcc	AltConf
			Total	O	S		
3	A	1	5	4	1	0	0

- Molecule 4 is CARBON DIOXIDE (three-letter code: CO2) (formula: CO<sub>2</sub>).

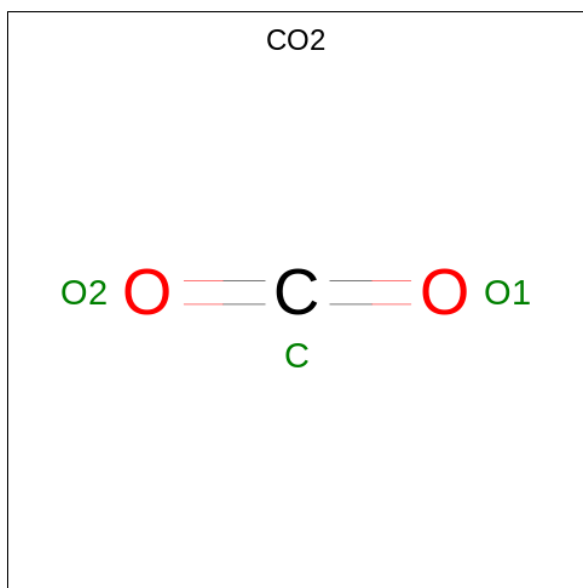

Mol	Chain	Residues	Atoms			ZeroOcc	AltConf
			Total	C	O		
4	A	1	3	1	2	0	0

- Molecule 5 is 1,2-ETHANEDIOL (three-letter code: EDO) (formula: C<sub>2</sub>H<sub>6</sub>O<sub>2</sub>).



Mol	Chain	Residues	Atoms	ZeroOcc	AltConf
5	A	1	Total C O 4 2 2	0	0
5	A	1	Total C O 4 2 2	0	0
5	A	1	Total C O 4 2 2	0	0
5	A	1	Total C O 4 2 2	0	0

- Molecule 6 is DI(HYDROXYETHYL)ETHER (three-letter code: PEG) (formula: C<sub>4</sub>H<sub>10</sub>O<sub>3</sub>).

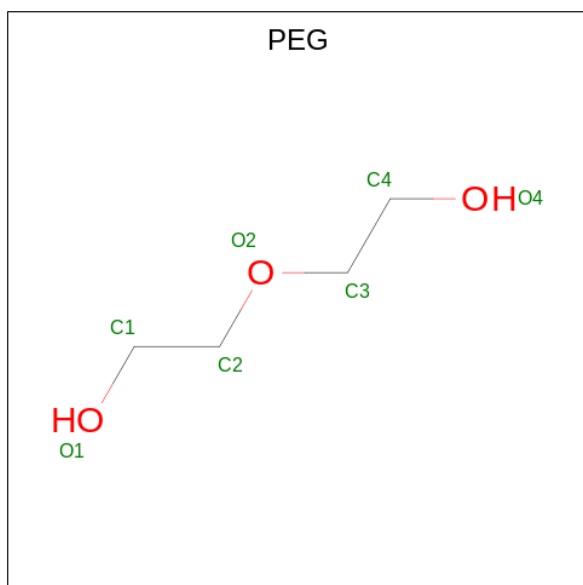

Mol	Chain	Residues	Atoms			ZeroOcc	AltConf
6	A	1	Total	C	O	0	0
			7	4	3		

- Molecule 7 is 2-HYDROXY BUTANE-1,4-DIOL (three-letter code: BGQ) (formula: C<sub>4</sub>H<sub>9</sub>O<sub>3</sub>).

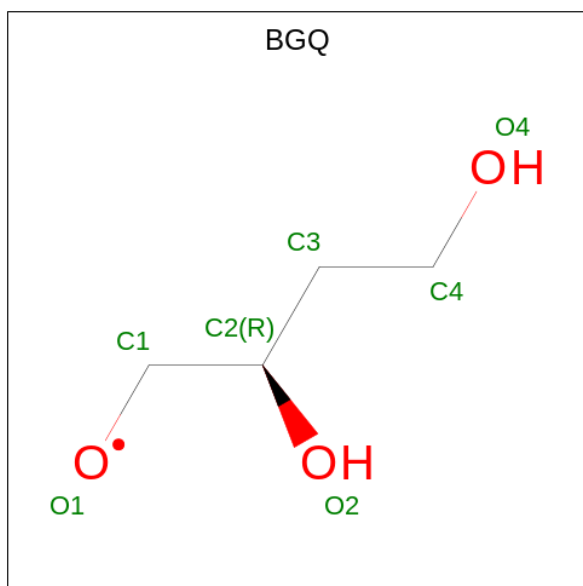

Mol	Chain	Residues	Atoms			ZeroOcc	AltConf
7	A	1	Total	C	O	0	0
			7	4	3		

- Molecule 8 is 2-(hydroxymethyl)butane-1,4-diol (three-letter code: 1MI) (formula: C<sub>5</sub>H<sub>12</sub>O<sub>3</sub>).

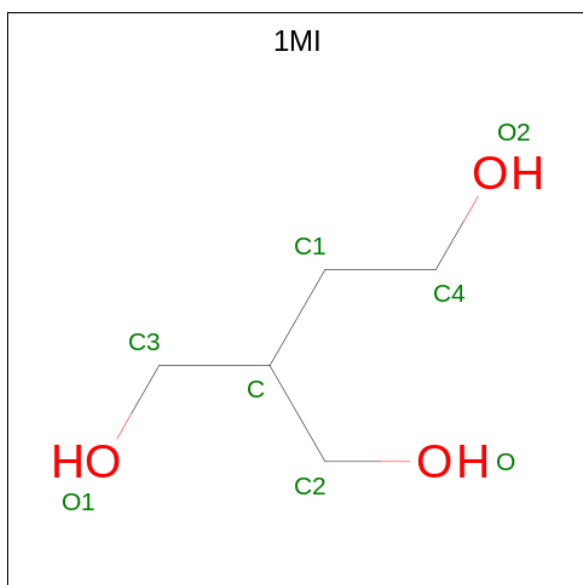

Mol	Chain	Residues	Atoms			ZeroOcc	AltConf
8	A	1	Total	C	O	0	0
			8	5	3		

- Molecule 9 is CACODYLATE ION (three-letter code: CAC) (formula:  $C_2H_6AsO_2$ ).

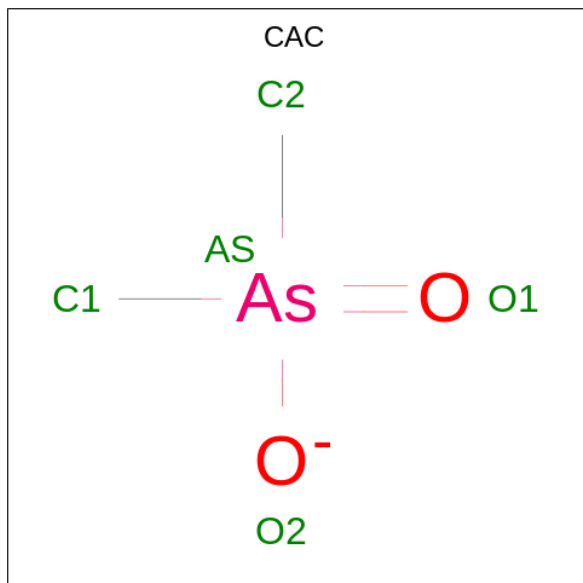

Mol	Chain	Residues	Atoms				ZeroOcc	AltConf
9	A	1	Total	As	C	O	0	0
			5	1	2	2		

- Molecule 10 is water.

Mol	Chain	Residues	Atoms		ZeroOcc	AltConf
10	A	281	Total	O	0	0
			281	281		

### 3 Residue-property plots [i](#)

These plots are drawn for all protein, RNA, DNA and oligosaccharide chains in the entry. The first graphic for a chain summarises the proportions of the various outlier classes displayed in the second graphic. The second graphic shows the sequence view annotated by issues in geometry and electron density. Residues are color-coded according to the number of geometric quality criteria for which they contain at least one outlier: green = 0, yellow = 1, orange = 2 and red = 3 or more. A red dot above a residue indicates a poor fit to the electron density ( $RSRZ > 2$ ). Stretches of 2 or more consecutive residues without any outlier are shown as a green connector. Residues present in the sample, but not in the model, are shown in grey.

- Molecule 1: Iron ABC transporter, periplasmic iron-binding protein

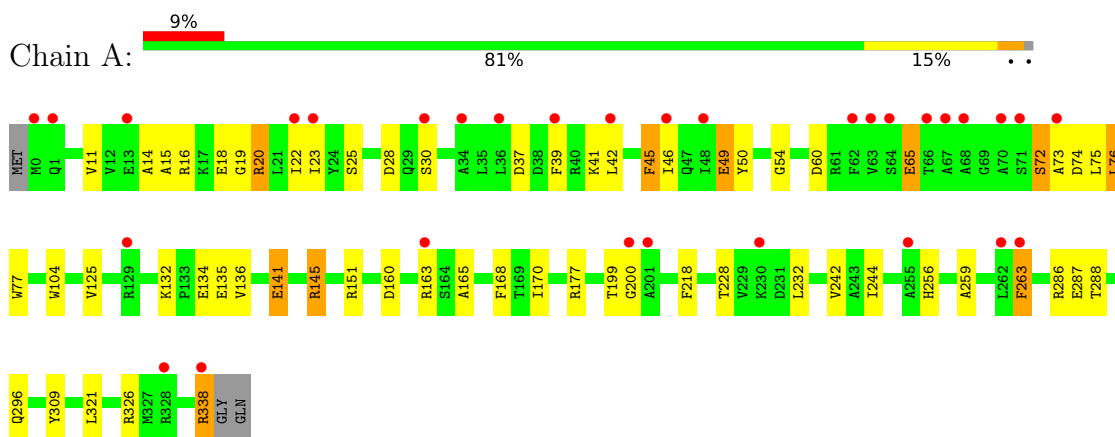



## 4 Data and refinement statistics

Property	Value	Source
Space group	I 2 2 2	Depositor
Cell constants a, b, c, $\alpha$ , $\beta$ , $\gamma$	44.42Å 108.61Å 163.17Å 90.00° 90.00° 90.00°	Depositor
Resolution (Å)	48.68 – 1.75 48.63 – 1.75	Depositor EDS
% Data completeness (in resolution range)	100.0 (48.68-1.75) 100.0 (48.63-1.75)	Depositor EDS
$R_{merge}$	0.09	Depositor
$R_{sym}$	(Not available)	Depositor
$\langle I/\sigma(I) \rangle$ <sup>1</sup>	2.26 (at 1.75Å)	Xtrriage
Refinement program	REFMAC 5.8.0267	Depositor
R, $R_{free}$	0.204 , 0.236 0.212 , 0.240	Depositor DCC
$R_{free}$ test set	1985 reflections (4.92%)	wwPDB-VP
Wilson B-factor (Å <sup>2</sup> )	23.0	Xtrriage
Anisotropy	0.272	Xtrriage
Bulk solvent $k_{sol}$ (e/Å <sup>3</sup> ), $B_{sol}$ (Å <sup>2</sup> )	0.34 , 40.9	EDS
L-test for twinning <sup>2</sup>	$\langle  L  \rangle = 0.50$ , $\langle L^2 \rangle = 0.34$	Xtrriage
Estimated twinning fraction	No twinning to report.	Xtrriage
$F_o, F_c$ correlation	0.95	EDS
Total number of atoms	3028	wwPDB-VP
Average B, all atoms (Å <sup>2</sup> )	29.0	wwPDB-VP

Xtrriage's analysis on translational NCS is as follows: *The largest off-origin peak in the Patterson function is 6.31% of the height of the origin peak. No significant pseudotranslation is detected.*

<sup>1</sup>Intensities estimated from amplitudes.

<sup>2</sup>Theoretical values of  $\langle |L| \rangle$ ,  $\langle L^2 \rangle$  for acentric reflections are 0.5, 0.333 respectively for untwinned datasets, and 0.375, 0.2 for perfectly twinned datasets.

## 5 Model quality i

### 5.1 Standard geometry i

Bond lengths and bond angles in the following residue types are not validated in this section: CAC, BGQ, NA, SO4, EDO, CO2, 1MI, PEG

The Z score for a bond length (or angle) is the number of standard deviations the observed value is removed from the expected value. A bond length (or angle) with  $|Z| > 5$  is considered an outlier worth inspection. RMSZ is the root-mean-square of all Z scores of the bond lengths (or angles).

Mol	Chain	Bond lengths		Bond angles	
		RMSZ	# Z  >5	RMSZ	# Z  >5
1	A	1.22	21/2767 (0.8%)	1.12	8/3752 (0.2%)

Chiral center outliers are detected by calculating the chiral volume of a chiral center and verifying if the center is modelled as a planar moiety or with the opposite hand. A planarity outlier is detected by checking planarity of atoms in a peptide group, atoms in a mainchain group or atoms of a sidechain that are expected to be planar.

Mol	Chain	#Chirality outliers	#Planarity outliers
1	A	0	2

The worst 5 of 21 bond length outliers are listed below:

Mol	Chain	Res	Type	Atoms	Z	Observed(Å)	Ideal(Å)
1	A	135	GLU	CD-OE1	14.49	1.41	1.25
1	A	65	GLU	CD-OE1	10.76	1.37	1.25
1	A	37	ASP	CG-OD1	10.18	1.48	1.25
1	A	42	LEU	C-O	-9.43	1.05	1.23
1	A	259	ALA	C-O	8.31	1.39	1.23

The worst 5 of 8 bond angle outliers are listed below:

Mol	Chain	Res	Type	Atoms	Z	Observed(°)	Ideal(°)
1	A	20	ARG	O-C-N	7.95	135.42	122.70
1	A	37	ASP	CB-CG-OD1	-7.85	111.23	118.30
1	A	50	TYR	CB-CA-C	7.59	125.58	110.40
1	A	145	ARG	NE-CZ-NH1	6.99	123.80	120.30
1	A	19	GLY	CA-C-O	-6.52	108.87	120.60

There are no chirality outliers.

All (2) planarity outliers are listed below:

Mol	Chain	Res	Type	Group
1	A	23	ILE	Peptide
1	A	45	PHE	Mainchain

## 5.2 Too-close contacts [i](#)

In the following table, the Non-H and H(model) columns list the number of non-hydrogen atoms and hydrogen atoms in the chain respectively. The H(added) column lists the number of hydrogen atoms added and optimized by MolProbity. The Clashes column lists the number of clashes within the asymmetric unit, whereas Symm-Clashes lists symmetry-related clashes.

Mol	Chain	Non-H	H(model)	H(added)	Clashes	Symm-Clashes
1	A	2694	0	2715	37	0
2	A	2	0	0	0	0
3	A	5	0	0	0	0
4	A	3	0	0	0	0
5	A	16	0	24	5	0
6	A	7	0	10	2	0
7	A	7	0	9	6	0
8	A	8	0	0	0	0
9	A	5	0	0	0	0
10	A	281	0	0	8	3
All	All	3028	0	2758	40	3

The all-atom clashscore is defined as the number of clashes found per 1000 atoms (including hydrogen atoms). The all-atom clashscore for this structure is 7.

The worst 5 of 40 close contacts within the same asymmetric unit are listed below, sorted by their clash magnitude.

Atom-1	Atom-2	Interatomic distance (Å)	Clash overlap (Å)
1:A:288:THR:HG21	7:A:410:BGQ:H32C	1.48	0.94
1:A:20:ARG:NH2	1:A:49[A]:GLU:OE1	2.03	0.91
1:A:287:GLU:HG3	10:A:578:HOH:O	1.87	0.73
1:A:286:ARG:HH11	7:A:410:BGQ:H41C	1.55	0.72
1:A:160:ASP:OD2	1:A:163:ARG:NH2	2.23	0.71

All (3) symmetry-related close contacts are listed below. The label for Atom-2 includes the symmetry operator and encoded unit-cell translations to be applied.

Atom-1	Atom-2	Interatomic distance (Å)	Clash overlap (Å)
10:A:695:HOH:O	10:A:695:HOH:O[3_555]	1.67	0.53

*Continued on next page...*

Continued from previous page...

Atom-1	Atom-2	Interatomic distance (Å)	Clash overlap (Å)
10:A:514:HOH:O	10:A:514:HOH:O[2_565]	1.75	0.45
10:A:750:HOH:O	10:A:771:HOH:O[8_455]	2.15	0.05

## 5.3 Torsion angles [i](#)

### 5.3.1 Protein backbone [i](#)

In the following table, the Percentiles column shows the percent Ramachandran outliers of the chain as a percentile score with respect to all X-ray entries followed by that with respect to entries of similar resolution.

The Analysed column shows the number of residues for which the backbone conformation was analysed, and the total number of residues.

Mol	Chain	Analysed	Favoured	Allowed	Outliers	Percentiles
1	A	342/342 (100%)	338 (99%)	4 (1%)	0	100 100

There are no Ramachandran outliers to report.

### 5.3.2 Protein sidechains [i](#)

In the following table, the Percentiles column shows the percent sidechain outliers of the chain as a percentile score with respect to all X-ray entries followed by that with respect to entries of similar resolution.

The Analysed column shows the number of residues for which the sidechain conformation was analysed, and the total number of residues.

Mol	Chain	Analysed	Rotameric	Outliers	Percentiles
1	A	276/273 (101%)	269 (98%)	7 (2%)	47 25

5 of 7 residues with a non-rotameric sidechain are listed below:

Mol	Chain	Res	Type
1	A	104	TRP
1	A	296	GLN
1	A	338	ARG
1	A	321	LEU
1	A	76	LEU

Sometimes sidechains can be flipped to improve hydrogen bonding and reduce clashes. There are

no such sidechains identified.

### 5.3.3 RNA [i](#)

There are no RNA molecules in this entry.

## 5.4 Non-standard residues in protein, DNA, RNA chains [i](#)

There are no non-standard protein/DNA/RNA residues in this entry.

## 5.5 Carbohydrates [i](#)

There are no monosaccharides in this entry.

## 5.6 Ligand geometry [i](#)

Of 12 ligands modelled in this entry, 2 are monoatomic - leaving 10 for Mogul analysis.

In the following table, the Counts columns list the number of bonds (or angles) for which Mogul statistics could be retrieved, the number of bonds (or angles) that are observed in the model and the number of bonds (or angles) that are defined in the Chemical Component Dictionary. The Link column lists molecule types, if any, to which the group is linked. The Z score for a bond length (or angle) is the number of standard deviations the observed value is removed from the expected value. A bond length (or angle) with  $|Z| > 2$  is considered an outlier worth inspection. RMSZ is the root-mean-square of all Z scores of the bond lengths (or angles).

Mol	Type	Chain	Res	Link	Bond lengths			Bond angles		
					Counts	RMSZ	$\# Z  > 2$	Counts	RMSZ	$\# Z  > 2$
8	IMI	A	411	-	7,7,7	0.55	0	6,7,7	0.62	0
5	EDO	A	406	-	3,3,3	0.13	0	2,2,2	0.25	0
5	EDO	A	408	-	3,3,3	0.36	0	2,2,2	0.54	0
6	PEG	A	409	-	6,6,6	0.40	0	5,5,5	0.34	0
9	CAC	A	412	2	0,4,4	-	-	0,6,6	-	-
5	EDO	A	405	-	3,3,3	0.26	0	2,2,2	0.52	0
4	CO2	A	404	-	2,2,2	0.36	0	1,1,1	0.76	0
7	BGQ	A	410	-	6,6,6	0.37	0	4,6,6	0.77	0
5	EDO	A	407	-	3,3,3	0.05	0	2,2,2	0.16	0
3	SO4	A	403	-	4,4,4	0.32	0	6,6,6	0.25	0

In the following table, the Chirals column lists the number of chiral outliers, the number of chiral centers analysed, the number of these observed in the model and the number defined in the Chemical Component Dictionary. Similar counts are reported in the Torsion and Rings columns. '-' means no outliers of that kind were identified.

Mol	Type	Chain	Res	Link	Chirals	Torsions	Rings
8	1MI	A	411	-	-	5/7/7/7	-
5	EDO	A	406	-	-	1/1/1/1	-
5	EDO	A	408	-	-	0/1/1/1	-
6	PEG	A	409	-	-	4/4/4/4	-
5	EDO	A	405	-	-	0/1/1/1	-
7	BGQ	A	410	-	-	3/5/5/5	-
5	EDO	A	407	-	-	1/1/1/1	-

There are no bond length outliers.

There are no bond angle outliers.

There are no chirality outliers.

5 of 14 torsion outliers are listed below:

Mol	Chain	Res	Type	Atoms
7	A	410	BGQ	O1-C1-C2-C3
7	A	410	BGQ	C2-C3-C4-O4
8	A	411	1MI	C3-C-C1-C4
8	A	411	1MI	C2-C-C3-O1
6	A	409	PEG	O2-C3-C4-O4

There are no ring outliers.

3 monomers are involved in 13 short contacts:

Mol	Chain	Res	Type	Clashes	Symm-Clashes
5	A	408	EDO	5	0
6	A	409	PEG	2	0
7	A	410	BGQ	6	0

## 5.7 Other polymers [i](#)

There are no such residues in this entry.

## 5.8 Polymer linkage issues [i](#)

There are no chain breaks in this entry.

## 6 Fit of model and data [i](#)

### 6.1 Protein, DNA and RNA chains [i](#)

In the following table, the column labelled ‘#RSRZ> 2’ contains the number (and percentage) of RSRZ outliers, followed by percent RSRZ outliers for the chain as percentile scores relative to all X-ray entries and entries of similar resolution. The OWAB column contains the minimum, median, 95<sup>th</sup> percentile and maximum values of the occupancy-weighted average B-factor per residue. The column labelled ‘Q< 0.9’ lists the number of (and percentage) of residues with an average occupancy less than 0.9.

Mol	Chain	Analysed	<RSRZ>	#RSRZ>2	OWAB(Å <sup>2</sup> )	Q<0.9
1	A	339/342 (99%)	0.66	31 (9%) <b>9</b> <b>11</b>	14, 25, 49, 89	0

The worst 5 of 31 RSRZ outliers are listed below:

Mol	Chain	Res	Type	RSRZ
1	A	0	MET	7.6
1	A	338	ARG	4.4
1	A	68	ALA	4.3
1	A	71	SER	3.4
1	A	63	VAL	3.4

### 6.2 Non-standard residues in protein, DNA, RNA chains [i](#)

There are no non-standard protein/DNA/RNA residues in this entry.

### 6.3 Carbohydrates [i](#)

There are no monosaccharides in this entry.

### 6.4 Ligands [i](#)

In the following table, the Atoms column lists the number of modelled atoms in the group and the number defined in the chemical component dictionary. The B-factors column lists the minimum, median, 95<sup>th</sup> percentile and maximum values of B factors of atoms in the group. The column labelled ‘Q< 0.9’ lists the number of atoms with occupancy less than 0.9.

Mol	Type	Chain	Res	Atoms	RSCC	RSR	B-factors(Å <sup>2</sup> )	Q<0.9
6	PEG	A	409	7/7	0.48	0.29	41,47,51,54	0
5	EDO	A	405	4/4	0.60	0.26	49,53,53,54	0

*Continued on next page...*

*Continued from previous page...*

Mol	Type	Chain	Res	Atoms	RSCC	RSR	B-factors( $\text{\AA}^2$ )	Q<0.9
5	EDO	A	406	4/4	0.65	0.17	58,59,60,61	0
5	EDO	A	408	4/4	0.79	0.29	33,33,34,38	0
5	EDO	A	407	4/4	0.86	0.12	54,54,55,58	0
8	1MI	A	411	8/8	0.86	0.15	29,34,40,43	0
7	BGQ	A	410	7/7	0.87	0.13	37,40,44,47	0
9	CAC	A	412	5/5	0.92	0.19	82,84,86,88	0
2	NA	A	402	1/1	0.93	0.09	36,36,36,36	0
3	SO4	A	403	5/5	0.94	0.28	37,45,48,48	0
4	CO2	A	404	3/3	0.95	0.23	34,34,36,42	0
2	NA	A	401	1/1	1.00	0.11	23,23,23,23	0

## 6.5 Other polymers [i](#)

There are no such residues in this entry.