



# wwPDB X-ray Structure Validation Summary Report ⓘ

Mar 10, 2022 – 12:15 PM JST

PDB ID : 7E1B  
Title : Crystal structure of VbrR-DNA complex  
Authors : Hong, S.; Zhang, X.; Zhang, P.  
Deposited on : 2021-02-01  
Resolution : 4.59 Å(reported)

This is a wwPDB X-ray Structure Validation Summary Report for a publicly released PDB entry.

We welcome your comments at [validation@mail.wwpdb.org](mailto:validation@mail.wwpdb.org)

A user guide is available at

<https://www.wwpdb.org/validation/2017/XrayValidationReportHelp>

with specific help available everywhere you see the ⓘ symbol.

---

The following versions of software and data (see [references ⓘ](#)) were used in the production of this report:

MolProbity : 4.02b-467  
Xtriage (Phenix) : 1.13  
EDS : 2.27  
Percentile statistics : 20191225.v01 (using entries in the PDB archive December 25th 2019)  
Refmac : 5.8.0158  
CCP4 : 7.0.044 (Gargrove)  
Ideal geometry (proteins) : Engh & Huber (2001)  
Ideal geometry (DNA, RNA) : Parkinson et al. (1996)  
Validation Pipeline (wwPDB-VP) : 2.27

# 1 Overall quality at a glance

The following experimental techniques were used to determine the structure:

*X-RAY DIFFRACTION*

The reported resolution of this entry is 4.59 Å.

Percentile scores (ranging between 0-100) for global validation metrics of the entry are shown in the following graphic. The table shows the number of entries on which the scores are based.

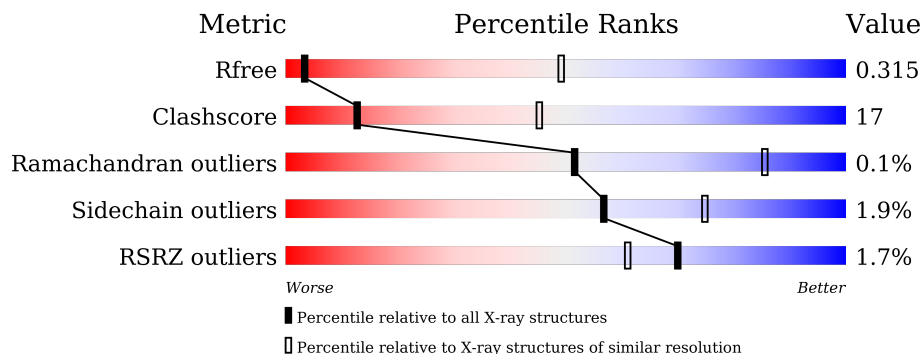





Metric	Whole archive (#Entries)	Similar resolution (#Entries, resolution range(Å))
$R_{free}$	130704	1060 (5.30-3.80)
Clashscore	141614	1128 (5.30-3.80)
Ramachandran outliers	138981	1072 (5.30-3.80)
Sidechain outliers	138945	1053 (5.30-3.80)
RSRZ outliers	127900	1102 (5.46-3.70)

The table below summarises the geometric issues observed across the polymeric chains and their fit to the electron density. The red, orange, yellow and green segments of the lower bar indicate the fraction of residues that contain outliers for  $\geq 3$ , 2, 1 and 0 types of geometric quality criteria respectively. A grey segment represents the fraction of residues that are not modelled. The numeric value for each fraction is indicated below the corresponding segment, with a dot representing fractions  $\leq 5\%$ . The upper red bar (where present) indicates the fraction of residues that have poor fit to the electron density. The numeric value is given above the bar.

Mol	Chain	Length	Quality of chain
1	A	220	
1	B	220	
1	C	220	
1	D	220	
1	E	220	
1	F	220	

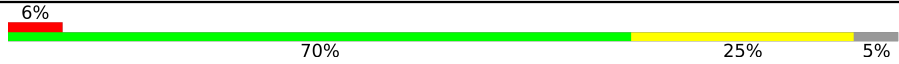
*Continued on next page...*

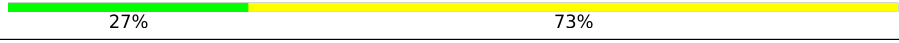
*Continued from previous page...*

Mol	Chain	Length	Quality of chain
1	G	220	
1	H	220	
2	I	26	
2	Y	26	
3	J	26	
3	Z	26	

## 2 Entry composition

There are 3 unique types of molecules in this entry. The entry contains 15460 atoms, of which 0 are hydrogens and 0 are deuteriums.

In the tables below, the ZeroOcc column contains the number of atoms modelled with zero occupancy, the AltConf column contains the number of residues with at least one atom in alternate conformation and the Trace column contains the number of residues modelled with at most 2 atoms.

- Molecule 1 is a protein called DNA-binding response regulator.

Mol	Chain	Residues	Atoms					ZeroOcc	AltConf	Trace
			Total	C	N	O	S			
1	A	209	Total 1668	C 1064	N 288	O 313	S 3	0	0	0
1	B	208	Total 1664	C 1062	N 287	O 311	S 4	0	0	0
1	C	209	Total 1668	C 1064	N 288	O 313	S 3	0	0	0
1	D	208	Total 1664	C 1062	N 287	O 311	S 4	0	0	0
1	E	209	Total 1671	C 1066	N 288	O 313	S 4	0	0	0
1	F	208	Total 1661	C 1060	N 287	O 311	S 3	0	0	0
1	G	209	Total 1671	C 1066	N 288	O 313	S 4	0	0	0
1	H	208	Total 1661	C 1060	N 287	O 311	S 3	0	0	0

- Molecule 2 is a DNA chain called DNA (26-MER).

Mol	Chain	Residues	Atoms					ZeroOcc	AltConf	Trace
			Total	C	N	O	P			
2	Y	26	Total 523	C 253	N 83	O 161	P 26	0	0	0
2	I	26	Total 523	C 253	N 83	O 161	P 26	0	0	0

- Molecule 3 is a DNA chain called DNA (26-MER).

Mol	Chain	Residues	Atoms					ZeroOcc	AltConf	Trace
			Total	C	N	O	P			
3	Z	26	Total 543	C 258	N 108	O 151	P 26	0	0	0
3	J	26	Total 543	C 258	N 108	O 151	P 26	0	0	0

### 3 Residue-property plots [i](#)

These plots are drawn for all protein, RNA, DNA and oligosaccharide chains in the entry. The first graphic for a chain summarises the proportions of the various outlier classes displayed in the second graphic. The second graphic shows the sequence view annotated by issues in geometry and electron density. Residues are color-coded according to the number of geometric quality criteria for which they contain at least one outlier: green = 0, yellow = 1, orange = 2 and red = 3 or more. A red dot above a residue indicates a poor fit to the electron density ( $RSRZ > 2$ ). Stretches of 2 or more consecutive residues without any outlier are shown as a green connector. Residues present in the sample, but not in the model, are shown in grey.

- Molecule 1: DNA-binding response regulator

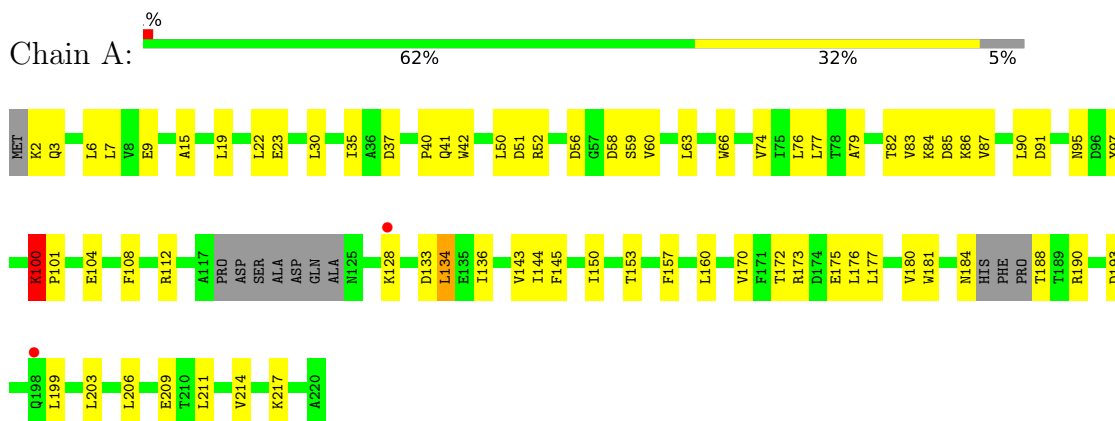

- Molecule 1: DNA-binding response regulator

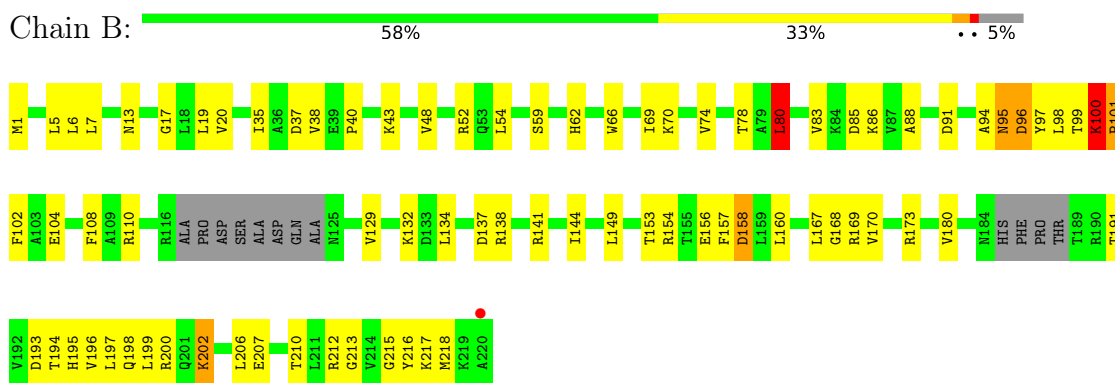

- Molecule 1: DNA-binding response regulator

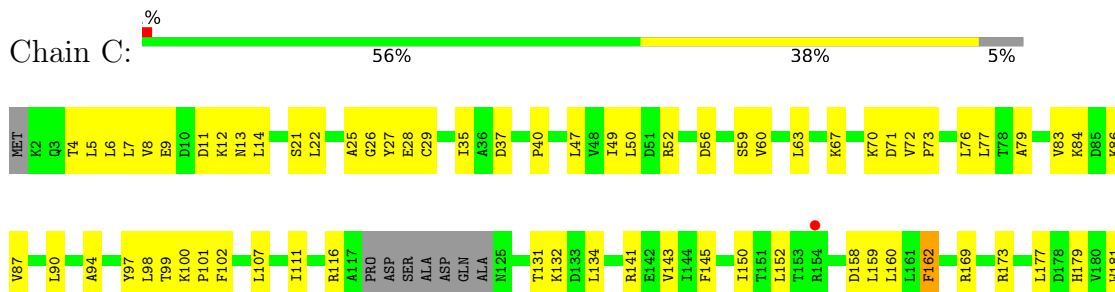



- Molecule 1: DNA-binding response regulator

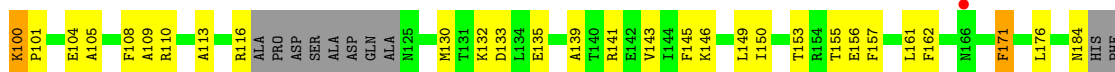
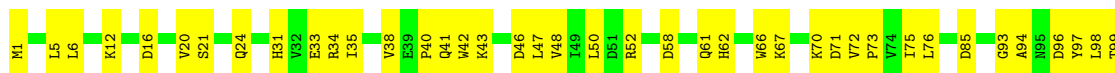

- Molecule 1: DNA-binding response regulator



- Molecule 1: DNA-binding response regulator

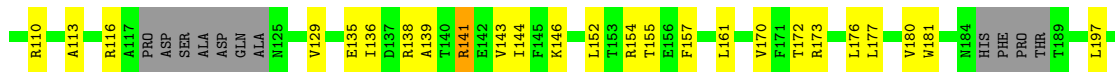

- Molecule 1: DNA-binding response regulator



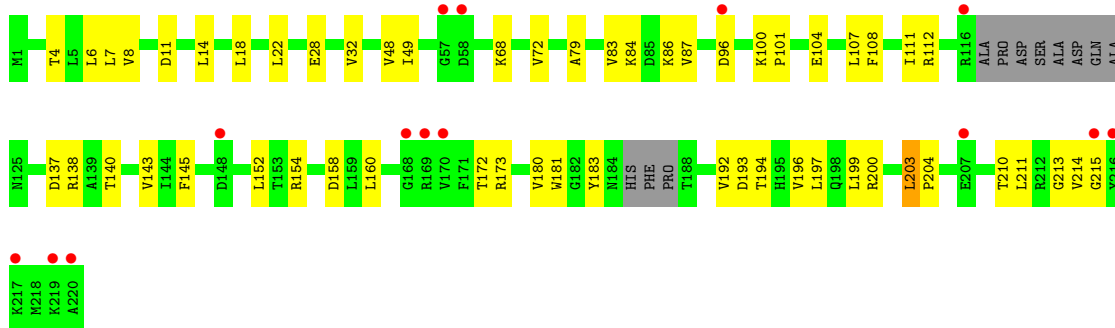

- Molecule 1: DNA-binding response regulator

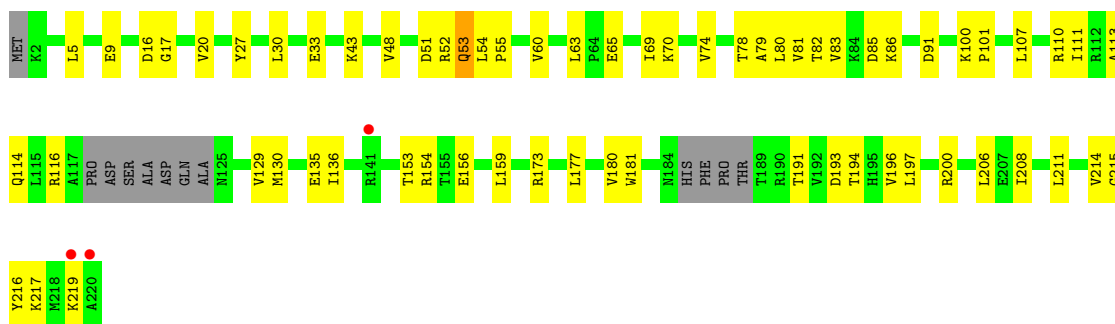

- Molecule 2: DNA (26-MER)

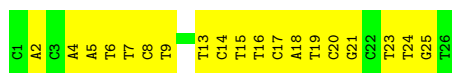

- Molecule 2: DNA (26-MER)

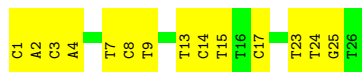

- Molecule 3: DNA (26-MER)



- Molecule 3: DNA (26-MER)



A1	C2	A3	A4	G5	C6	G7	A8	T9	G10	A11	A18	G24	T25	G26
----	----	----	----	----	----	----	----	----	-----	-----	-----	-----	-----	-----



## 4 Data and refinement statistics i

Property	Value	Source
Space group	C 1 2 1	Depositor
Cell constants a, b, c, $\alpha$ , $\beta$ , $\gamma$	329.94Å 114.06Å 114.04Å 90.00° 110.02° 90.00°	Depositor
Resolution (Å)	46.01 – 4.59 46.00 – 4.59	Depositor EDS
% Data completeness (in resolution range)	71.1 (46.01-4.59) 65.4 (46.00-4.59)	Depositor EDS
$R_{merge}$	0.07	Depositor
$R_{sym}$	(Not available)	Depositor
$\langle I/\sigma(I) \rangle$ <sup>1</sup>	1.79 (at 4.64Å)	Xtrriage
Refinement program	PHENIX 1.14_3260	Depositor
R, $R_{free}$	0.265 , 0.321 0.263 , 0.315	Depositor DCC
$R_{free}$ test set	1597 reflections (9.98%)	wwPDB-VP
Wilson B-factor (Å <sup>2</sup> )	78.2	Xtrriage
Anisotropy	0.259	Xtrriage
Bulk solvent $k_{sol}$ (e/Å <sup>3</sup> ), $B_{sol}$ (Å <sup>2</sup> )	0.29 , 113.6	EDS
L-test for twinning <sup>2</sup>	$\langle  L  \rangle = 0.47$ , $\langle L^2 \rangle = 0.30$	Xtrriage
Estimated twinning fraction	0.389 for -h-k-l,l,k 0.398 for -h+k-l,-l,-k 0.408 for -h-2*l,-k,l	Xtrriage
Reported twinning fraction	0.450 for -h-k-l,l,k	Depositor
Outliers	0 of 15997 reflections	Xtrriage
$F_o, F_c$ correlation	0.83	EDS
Total number of atoms	15460	wwPDB-VP
Average B, all atoms (Å <sup>2</sup> )	140.0	wwPDB-VP

Xtrriage's analysis on translational NCS is as follows: *The largest off-origin peak in the Patterson function is 4.23% of the height of the origin peak. No significant pseudotranslation is detected.*

<sup>1</sup>Intensities estimated from amplitudes.

<sup>2</sup>Theoretical values of  $\langle |L| \rangle$ ,  $\langle L^2 \rangle$  for acentric reflections are 0.5, 0.333 respectively for untwinned datasets, and 0.375, 0.2 for perfectly twinned datasets.

## 5 Model quality [i](#)

### 5.1 Standard geometry [i](#)

The Z score for a bond length (or angle) is the number of standard deviations the observed value is removed from the expected value. A bond length (or angle) with  $|Z| > 5$  is considered an outlier worth inspection. RMSZ is the root-mean-square of all Z scores of the bond lengths (or angles).

Mol	Chain	Bond lengths		Bond angles	
		RMSZ	# Z  >5	RMSZ	# Z  >5
1	A	0.26	0/1691	0.52	1/2287 (0.0%)
1	B	0.35	0/1687	0.66	4/2280 (0.2%)
1	C	0.24	0/1691	0.48	0/2287
1	D	0.30	0/1687	0.56	0/2280
1	E	0.26	0/1694	0.56	3/2290 (0.1%)
1	F	0.25	0/1684	0.48	0/2277
1	G	0.24	0/1694	0.46	0/2290
1	H	0.25	0/1684	0.48	0/2277
2	I	0.48	0/582	1.00	0/894
2	Y	0.47	0/582	1.01	0/894
3	J	0.52	0/612	0.87	0/944
3	Z	0.51	0/612	0.83	0/944
All	All	0.31	0/15900	0.62	8/21944 (0.0%)

Chiral center outliers are detected by calculating the chiral volume of a chiral center and verifying if the center is modelled as a planar moiety or with the opposite hand. A planarity outlier is detected by checking planarity of atoms in a peptide group, atoms in a mainchain group or atoms of a sidechain that are expected to be planar.

Mol	Chain	#Chirality outliers	#Planarity outliers
1	A	0	1

There are no bond length outliers.

The worst 5 of 8 bond angle outliers are listed below:

Mol	Chain	Res	Type	Atoms	Z	Observed(°)	Ideal(°)
1	B	80	LEU	CB-CG-CD2	11.30	130.22	111.00
1	E	82	THR	N-CA-CB	6.91	123.44	110.30
1	B	101	PRO	CA-N-CD	-6.20	102.82	111.50
1	B	100	LYS	C-N-CD	5.69	140.34	128.40
1	E	80	LEU	N-CA-C	-5.69	95.65	111.00

There are no chirality outliers.

All (1) planarity outliers are listed below:

Mol	Chain	Res	Type	Group
1	A	91	ASP	Peptide

## 5.2 Too-close contacts [i](#)

In the following table, the Non-H and H(model) columns list the number of non-hydrogen atoms and hydrogen atoms in the chain respectively. The H(added) column lists the number of hydrogen atoms added and optimized by MolProbity. The Clashes column lists the number of clashes within the asymmetric unit, whereas Symm-Clashes lists symmetry-related clashes.

Mol	Chain	Non-H	H(model)	H(added)	Clashes	Symm-Clashes
1	A	1668	0	1718	64	0
1	B	1664	0	1718	88	0
1	C	1668	0	1718	63	0
1	D	1664	0	1718	58	1
1	E	1671	0	1725	58	0
1	F	1661	0	1711	63	0
1	G	1671	0	1725	41	0
1	H	1661	0	1711	52	0
2	I	523	0	298	19	0
2	Y	523	0	298	20	0
3	J	543	0	293	16	1
3	Z	543	0	293	22	0
All	All	15460	0	14926	485	1

The all-atom clashscore is defined as the number of clashes found per 1000 atoms (including hydrogen atoms). The all-atom clashscore for this structure is 17.

The worst 5 of 485 close contacts within the same asymmetric unit are listed below, sorted by their clash magnitude.

Atom-1	Atom-2	Interatomic distance (Å)	Clash overlap (Å)
1:B:78:THR:HG23	1:B:80:LEU:HD22	1.18	1.08
1:B:78:THR:HG23	1:B:80:LEU:CD2	1.84	1.06
1:F:98:LEU:HD23	1:F:99:THR:H	1.23	0.99
1:H:100:LYS:HG3	1:H:101:PRO:HD3	1.48	0.96
1:B:100:LYS:HB2	1:B:101:PRO:HD2	1.55	0.89

All (1) symmetry-related close contacts are listed below. The label for Atom-2 includes the symmetry operator and encoded unit-cell translations to be applied.

Atom-1	Atom-2	Interatomic distance (Å)	Clash overlap (Å)
1:D:212:ARG:NH2	3:J:8:DA:O3'[1_566]	2.08	0.12

### 5.3 Torsion angles [i](#)

#### 5.3.1 Protein backbone [i](#)

In the following table, the Percentiles column shows the percent Ramachandran outliers of the chain as a percentile score with respect to all X-ray entries followed by that with respect to entries of similar resolution.

The Analysed column shows the number of residues for which the backbone conformation was analysed, and the total number of residues.

Mol	Chain	Analysed	Favoured	Allowed	Outliers	Percentiles	
1	A	203/220 (92%)	189 (93%)	14 (7%)	0	100	100
1	B	202/220 (92%)	190 (94%)	10 (5%)	2 (1%)	15	54
1	C	203/220 (92%)	189 (93%)	14 (7%)	0	100	100
1	D	202/220 (92%)	185 (92%)	17 (8%)	0	100	100
1	E	203/220 (92%)	190 (94%)	13 (6%)	0	100	100
1	F	202/220 (92%)	180 (89%)	22 (11%)	0	100	100
1	G	203/220 (92%)	189 (93%)	14 (7%)	0	100	100
1	H	202/220 (92%)	183 (91%)	19 (9%)	0	100	100
All	All	1620/1760 (92%)	1495 (92%)	123 (8%)	2 (0%)	51	85

All (2) Ramachandran outliers are listed below:

Mol	Chain	Res	Type
1	B	100	LYS
1	B	96	ASP

#### 5.3.2 Protein sidechains [i](#)

In the following table, the Percentiles column shows the percent sidechain outliers of the chain as a percentile score with respect to all X-ray entries followed by that with respect to entries of similar resolution.

The Analysed column shows the number of residues for which the sidechain conformation was analysed, and the total number of residues.

Mol	Chain	Analysed	Rotameric	Outliers	Percentiles	
1	A	182/191 (95%)	178 (98%)	4 (2%)	52	71
1	B	182/191 (95%)	174 (96%)	8 (4%)	28	54
1	C	182/191 (95%)	180 (99%)	2 (1%)	73	85
1	D	182/191 (95%)	178 (98%)	4 (2%)	52	71
1	E	183/191 (96%)	181 (99%)	2 (1%)	73	85
1	F	181/191 (95%)	177 (98%)	4 (2%)	52	71
1	G	183/191 (96%)	181 (99%)	2 (1%)	73	85
1	H	181/191 (95%)	179 (99%)	2 (1%)	73	85
All	All	1456/1528 (95%)	1428 (98%)	28 (2%)	57	75

5 of 28 residues with a non-rotameric sidechain are listed below:

Mol	Chain	Res	Type
1	D	71	ASP
1	H	91	ASP
1	D	171	PHE
1	G	183	TYR
1	D	162	PHE

Sometimes sidechains can be flipped to improve hydrogen bonding and reduce clashes. There are no such sidechains identified.

### 5.3.3 RNA [i](#)

There are no RNA molecules in this entry.

## 5.4 Non-standard residues in protein, DNA, RNA chains [i](#)

There are no non-standard protein/DNA/RNA residues in this entry.

## 5.5 Carbohydrates [i](#)

There are no monosaccharides in this entry.

## 5.6 Ligand geometry [i](#)

There are no ligands in this entry.

## 5.7 Other polymers [i](#)

There are no such residues in this entry.

## 5.8 Polymer linkage issues [i](#)

There are no chain breaks in this entry.

## 6 Fit of model and data [i](#)

### 6.1 Protein, DNA and RNA chains [i](#)

In the following table, the column labelled ‘#RSRZ > 2’ contains the number (and percentage) of RSRZ outliers, followed by percent RSRZ outliers for the chain as percentile scores relative to all X-ray entries and entries of similar resolution. The OWAB column contains the minimum, median, 95<sup>th</sup> percentile and maximum values of the occupancy-weighted average B-factor per residue. The column labelled ‘Q < 0.9’ lists the number of (and percentage) of residues with an average occupancy less than 0.9.

Mol	Chain	Analysed	<RSRZ>	#RSRZ>2	OWAB(Å <sup>2</sup> )	Q<0.9
1	A	209/220 (95%)	-0.03	2 (0%) 82 74	86, 96, 147, 151	0
1	B	208/220 (94%)	-0.12	1 (0%) 91 85	84, 98, 137, 139	0
1	C	209/220 (95%)	-0.01	2 (0%) 82 74	87, 100, 139, 142	0
1	D	208/220 (94%)	-0.12	2 (0%) 82 74	81, 89, 132, 142	0
1	E	209/220 (95%)	0.14	5 (2%) 59 49	162, 168, 173, 174	0
1	F	208/220 (94%)	0.02	1 (0%) 91 85	150, 167, 172, 173	0
1	G	209/220 (95%)	0.41	14 (6%) 17 15	153, 167, 181, 183	0
1	H	208/220 (94%)	0.07	3 (1%) 75 66	147, 164, 168, 171	0
2	I	26/26 (100%)	-0.22	0 100 100	141, 164, 176, 178	0
2	Y	26/26 (100%)	-0.35	0 100 100	135, 140, 155, 161	0
3	J	26/26 (100%)	-0.40	0 100 100	141, 165, 178, 179	0
3	Z	26/26 (100%)	-0.21	0 100 100	135, 143, 159, 160	0
All	All	1772/1864 (95%)	0.02	30 (1%) 70 61	81, 149, 174, 183	0

The worst 5 of 30 RSRZ outliers are listed below:

Mol	Chain	Res	Type	RSRZ
1	G	217	LYS	5.9
1	G	220	ALA	5.9
1	G	219	LYS	5.0
1	G	58	ASP	4.4
1	G	57	GLY	4.1

### 6.2 Non-standard residues in protein, DNA, RNA chains [i](#)

There are no non-standard protein/DNA/RNA residues in this entry.

### 6.3 Carbohydrates [i](#)

There are no monosaccharides in this entry.

### 6.4 Ligands [i](#)

There are no ligands in this entry.

### 6.5 Other polymers [i](#)

There are no such residues in this entry.