



wwPDB EM Validation Summary Report ⓘ

Apr 24, 2023 – 11:50 am BST

PDB ID : 8BSI
EMDB ID : EMD-16225
Title : Giardia ribosome chimeric hybrid-like GDP+Pi bound state (B1)
Authors : Majumdar, S.; Emmerich, A.G.; Sanyal, S.
Deposited on : 2022-11-25
Resolution : 3.40 Å (reported)

This is a wwPDB EM Validation Summary Report for a publicly released PDB entry.

We welcome your comments at validation@mail.wwpdb.org

A user guide is available at

<https://www.wwpdb.org/validation/2017/EMValidationReportHelp>

with specific help available everywhere you see the ⓘ symbol.

The types of validation reports are described at

<http://www.wwpdb.org/validation/2017/FAQs#types>.

The following versions of software and data (see [references ⓘ](#)) were used in the production of this report:

EMDB validation analysis : 0.0.1.dev50
Mogul : 1.8.4, CSD as541be (2020)
MolProbity : 4.02b-467
buster-report : 1.1.7 (2018)
Percentile statistics : 20191225.v01 (using entries in the PDB archive December 25th 2019)
MapQ : 1.9.9
Ideal geometry (proteins) : Engh & Huber (2001)
Ideal geometry (DNA, RNA) : Parkinson et al. (1996)
Validation Pipeline (wwPDB-VP) : 2.32.2

1 Overall quality at a glance

The following experimental techniques were used to determine the structure:
ELECTRON MICROSCOPY

The reported resolution of this entry is 3.40 Å.

Percentile scores (ranging between 0-100) for global validation metrics of the entry are shown in the following graphic. The table shows the number of entries on which the scores are based.

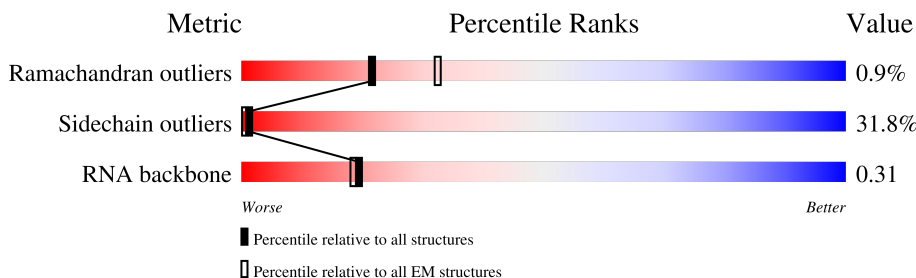











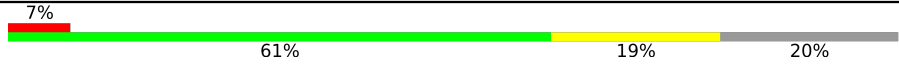

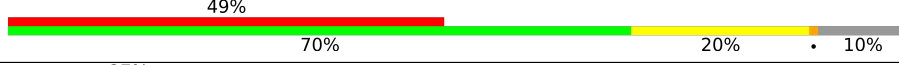
Metric	Whole archive (#Entries)	EM structures (#Entries)
Ramachandran outliers	154571	4023
Sidechain outliers	154315	3826
RNA backbone	4643	859

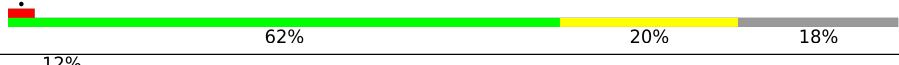
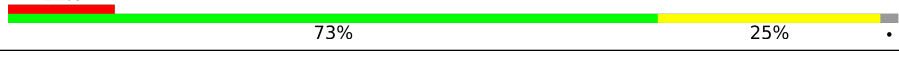
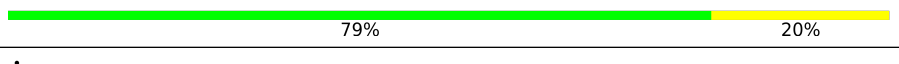
The table below summarises the geometric issues observed across the polymeric chains and their fit to the map. The red, orange, yellow and green segments of the bar indicate the fraction of residues that contain outliers for ≥ 3 , 2, 1 and 0 types of geometric quality criteria respectively. A grey segment represents the fraction of residues that are not modelled. The numeric value for each fraction is indicated below the corresponding segment, with a dot representing fractions $\leq 5\%$. The upper red bar (where present) indicates the fraction of residues that have poor fit to the EM map (all-atom inclusion $< 40\%$). The numeric value is given above the bar.

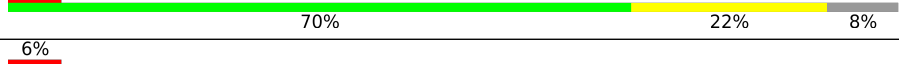
Mol	Chain	Length	Quality of chain
1	LA	251	
2	LB	379	
3	LC	316	
4	LD	142	
5	LE	121	
6	LF	297	
7	LG	51	
8	LH	235	

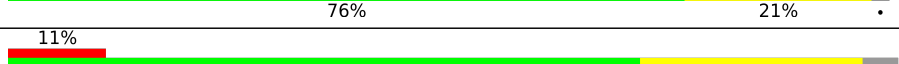
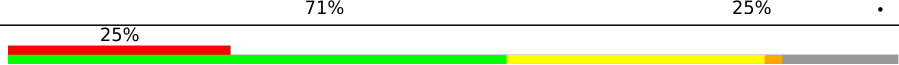
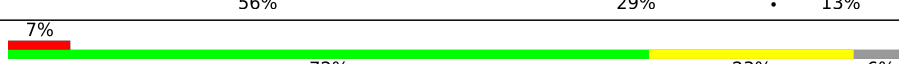
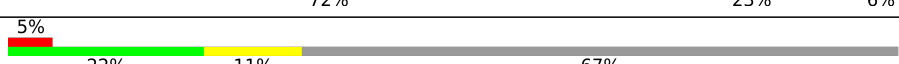
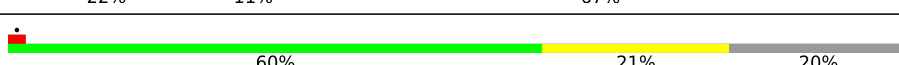
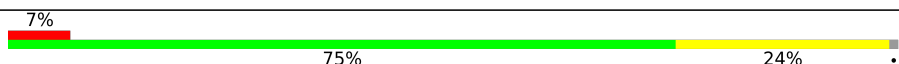
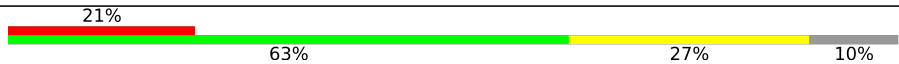
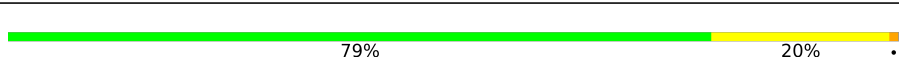
Continued on next page...

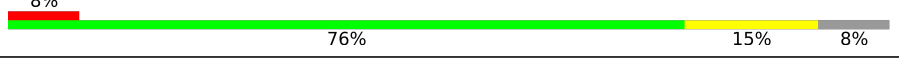
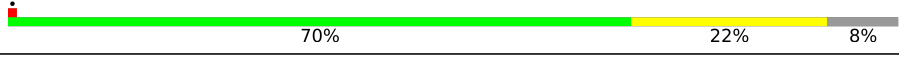
Continued from previous page...

Mol	Chain	Length	Quality of chain
9	LI	225	
10	LJ	185	
11	LK	210	
12	LL	173	
13	LM	234	
14	LN	131	
15	LO	204	
16	LP	197	
17	LQ	164	
18	LR	179	
19	LS	196	
20	LT	173	
21	LU	159	
22	LV	124	
23	LW	142	
24	LX	189	
25	LY	141	
26	LZ	135	
27	La	135	
28	Lb	149	
29	Lc	62	
30	Ld	109	
31	Le	106	
32	Lf	136	
33	Lg	123	

Continued on next page...

Continued from previous page...

Mol	Chain	Length	Quality of chain
34	Lh	120	
35	Li	124	
36	Lj	90	
37	Lk	89	
38	Ll	77	
39	Ln	217	
40	Lo	25	
41	Lp	106	
42	Lq	94	
43	Ls	127	
44	Lt	2697	
45	Lu	75	
46	SA	245	
47	SB	242	
48	SC	217	
49	SD	248	
50	SE	268	
51	SF	190	
52	SG	248	
53	SH	190	
54	SI	174	
55	SJ	130	
56	SK	189	
57	SL	134	
58	SM	154	

Continued on next page...

Continued from previous page...

Mol	Chain	Length	Quality of chain
59	SO	143	17% 64% 31% 5%
60	SP	154	34% 73% 23% ..
61	SQ	145	15% 66% 19% 14%
62	SR	145	39% 57% 21% 23%
63	ST	158	44% 63% 32% .
64	SU	137	21% 32% 15% 52%
65	SV	154	51% 56% 33% 9%
66	SW	139	51% 64% 34% ..
67	SX	126	48% 61% 20% 19%
68	SY	89	45% 58% 33% 8%
69	Sb	132	67% 52% 37% 11%
70	Sc	88	49% 53% 26% 19%
71	Sd	109	18% 67% 23% 10%
72	Se	81	72% 57% 42% .
73	Sg	64	58% 50% 42% 6%
74	Sh	51	25% 55% 41% .
75	Sj	69	57% 51% 42% 7%
76	St	1454	9% 53% 46% .
77	a	898	52% 62% 28% 9%
78	y	11	82% 9% 82% 9%

2 Entry composition [i](#)

There are 80 unique types of molecules in this entry. The entry contains 180812 atoms, of which 0 are hydrogens and 0 are deuteriums.

In the tables below, the AltConf column contains the number of residues with at least one atom in alternate conformation and the Trace column contains the number of residues modelled with at most 2 atoms.

- Molecule 1 is a protein called Ribosomal protein L2.

Mol	Chain	Residues	Atoms					AltConf	Trace
			Total	C	N	O	S		
1	LA	245	1847	1141	377	317	12	0	0

- Molecule 2 is a protein called Ribosomal protein L3.

Mol	Chain	Residues	Atoms					AltConf	Trace
			Total	C	N	O	S		
2	LB	372	2935	1852	559	503	21	0	0

- Molecule 3 is a protein called Ribosomal protein L4.

Mol	Chain	Residues	Atoms					AltConf	Trace
			Total	C	N	O	S		
3	LC	309	2412	1516	469	419	8	0	0

- Molecule 4 is a RNA chain called 5.8S rRNA.

Mol	Chain	Residues	Atoms					AltConf	Trace
			Total	C	N	O	P		
4	LD	137	2932	1303	544	948	137	0	0

- Molecule 5 is a RNA chain called 5S rRNA.

Mol	Chain	Residues	Atoms					AltConf	Trace
			Total	C	N	O	P		
5	LE	115	2457	1096	447	799	115	0	0

- Molecule 6 is a protein called Ribosomal protein L5.

Mol	Chain	Residues	Atoms					AltConf	Trace
			Total	C	N	O	S		
6	LF	285	2287	1444	428	407	8	0	0

- Molecule 7 is a protein called Ribosomal protein L39.

Mol	Chain	Residues	Atoms				AltConf	Trace
			Total	C	N	O		
7	LG	49	431	275	93	63	0	0

- Molecule 8 is a protein called Ribosomal protein L7.

Mol	Chain	Residues	Atoms					AltConf	Trace
			Total	C	N	O	S		
8	LH	209	1694	1079	307	303	5	0	0

- Molecule 9 is a protein called 60S ribosomal protein L7a.

Mol	Chain	Residues	Atoms					AltConf	Trace
			Total	C	N	O	S		
9	LI	180	1445	921	265	254	5	0	0

- Molecule 10 is a protein called Ribosomal protein L6.

Mol	Chain	Residues	Atoms					AltConf	Trace
			Total	C	N	O	S		
10	LJ	181	1427	902	260	255	10	0	0

- Molecule 11 is a protein called Ribosomal protein L10.

Mol	Chain	Residues	Atoms					AltConf	Trace
			Total	C	N	O	S		
11	LK	189	1552	978	303	264	7	0	0

- Molecule 12 is a protein called Ribosomal protein L11.

Mol	Chain	Residues	Atoms					AltConf	Trace
			Total	C	N	O	S		
12	LL	164	1321	835	246	235	5	0	0

- Molecule 13 is a protein called 60S ribosomal protein L13.

Mol	Chain	Residues	Atoms					AltConf	Trace
			Total	C	N	O	S		
13	LM	192	1539	957	312	264	6	0	0

- Molecule 14 is a protein called Ribosomal protein L14.

Mol	Chain	Residues	Atoms					AltConf	Trace
			Total	C	N	O	S		
14	LN	128	1006	637	184	179	6	0	0

- Molecule 15 is a protein called Ribosomal protein L15.

Mol	Chain	Residues	Atoms					AltConf	Trace
			Total	C	N	O	S		
15	LO	203	1708	1080	357	265	6	0	0

- Molecule 16 is a protein called Ribosomal protein L13a.

Mol	Chain	Residues	Atoms					AltConf	Trace
			Total	C	N	O	S		
16	LP	186	1513	948	297	256	12	0	0

- Molecule 17 is a protein called Ribosomal protein L17.

Mol	Chain	Residues	Atoms					AltConf	Trace
			Total	C	N	O	S		
17	LQ	151	1220	773	235	208	4	0	0

- Molecule 18 is a protein called Ribosomal protein L18.

Mol	Chain	Residues	Atoms					AltConf	Trace
			Total	C	N	O	S		
18	LR	177	1388	860	277	242	9	0	0

- Molecule 19 is a protein called Ribosomal protein L19.

Mol	Chain	Residues	Atoms					AltConf	Trace
			Total	C	N	O	S		
19	LS	181	1507	927	321	254	5	0	0

- Molecule 20 is a protein called 60S ribosomal protein L18a.

Mol	Chain	Residues	Atoms					AltConf	Trace
			Total	C	N	O	S		
20	LT	169	1418	896	271	242	9	0	0

- Molecule 21 is a protein called Ribosomal protein L21.

Mol	Chain	Residues	Atoms					AltConf	Trace
21	LU	153	Total	C	N	O	S	0	0
			1236	772	254	203	7		

- Molecule 22 is a protein called Ribosomal L22e.

Mol	Chain	Residues	Atoms					AltConf	Trace
22	LV	108	Total	C	N	O	S	0	0
			887	561	149	175	2		

- Molecule 23 is a protein called Ribosomal protein L23.

Mol	Chain	Residues	Atoms					AltConf	Trace
23	LW	134	Total	C	N	O	S	0	0
			1023	645	195	178	5		

- Molecule 24 is a protein called Ribosomal protein L24.

Mol	Chain	Residues	Atoms					AltConf	Trace
24	LX	63	Total	C	N	O	S	0	0
			538	340	109	82	7		

- Molecule 25 is a protein called Ribosomal protein L23A.

Mol	Chain	Residues	Atoms					AltConf	Trace
25	LY	113	Total	C	N	O	S	0	0
			913	588	163	159	3		

- Molecule 26 is a protein called Ribosomal protein L26.

Mol	Chain	Residues	Atoms					AltConf	Trace
26	LZ	133	Total	C	N	O	S	0	0
			1076	665	219	184	8		

- Molecule 27 is a protein called 60S ribosomal protein L27.

Mol	Chain	Residues	Atoms					AltConf	Trace
27	La	122	Total	C	N	O	S	0	0
			976	618	185	168	5		

- Molecule 28 is a protein called Ribosomal protein L27a.

Mol	Chain	Residues	Atoms					AltConf	Trace
28	Lb	148	Total	C	N	O	S	0	0
			1201	759	240	199	3		

- Molecule 29 is a protein called 60S ribosomal protein L29.

Mol	Chain	Residues	Atoms					AltConf	Trace
29	Lc	51	Total	C	N	O	S	0	0
			425	254	97	72	2		

- Molecule 30 is a protein called Ribosomal protein L30.

Mol	Chain	Residues	Atoms					AltConf	Trace
30	Ld	100	Total	C	N	O	S	0	0
			754	475	132	143	4		

- Molecule 31 is a protein called Ribosomal protein L31B.

Mol	Chain	Residues	Atoms				AltConf	Trace
31	Le	97	Total	C	N	O	0	0
			795	504	155	136		

- Molecule 32 is a protein called Ribosomal protein L32.

Mol	Chain	Residues	Atoms					AltConf	Trace
32	Lf	125	Total	C	N	O	S	0	0
			1031	655	206	164	6		

- Molecule 33 is a protein called Ribosomal protein L35a.

Mol	Chain	Residues	Atoms					AltConf	Trace
33	Lg	97	Total	C	N	O	S	0	0
			770	492	146	129	3		

- Molecule 34 is a protein called Ribosomal protein L34.

Mol	Chain	Residues	Atoms					AltConf	Trace
34	Lh	106	Total	C	N	O	S	0	0
			846	522	175	145	4		

- Molecule 35 is a protein called Ribosomal protein L29.

Mol	Chain	Residues	Atoms					AltConf	Trace
35	Li	115	Total	C	N	O	S	0	0
			931	590	182	154	5		

- Molecule 36 is a protein called Ribosomal protein L36-1.

Mol	Chain	Residues	Atoms					AltConf	Trace
36	Lj	83	Total	C	N	O	S	0	0
			677	430	135	108	4		

- Molecule 37 is a protein called Ribosomal protein L37.

Mol	Chain	Residues	Atoms					AltConf	Trace
37	Lk	86	Total	C	N	O	S	0	0
			697	426	149	115	7		

- Molecule 38 is a protein called Ribosomal L38e.

Mol	Chain	Residues	Atoms					AltConf	Trace
38	Ll	69	Total	C	N	O	S	0	0
			534	339	92	99	4		

- Molecule 39 is a protein called Ribosomal protein L10a.

Mol	Chain	Residues	Atoms					AltConf	Trace
39	Ln	200	Total	C	N	O	S	0	0
			1592	1025	278	284	5		

- Molecule 40 is a protein called 60S ribosomal protein L41.

Mol	Chain	Residues	Atoms					AltConf	Trace
40	Lo	25	Total	C	N	O	S	0	0
			227	140	57	27	3		

- Molecule 41 is a protein called Ribosomal protein L44.

Mol	Chain	Residues	Atoms					AltConf	Trace
41	Lp	92	Total	C	N	O	S	0	0
			759	472	158	124	5		

- Molecule 42 is a protein called Ribosomal protein L37a.

Mol	Chain	Residues	Atoms					AltConf	Trace
42	Lq	86	Total	C	N	O	S	0	0
			666	412	135	113	6		

- Molecule 43 is a protein called Ubiquitin/Ribosomal protein L40e.

Mol	Chain	Residues	Atoms					AltConf	Trace
43	Ls	45	Total	C	N	O	S	0	0
			374	226	81	61	6		

- Molecule 44 is a RNA chain called Large Subunit rRNA.

Mol	Chain	Residues	Atoms					AltConf	Trace
44	Lt	2593	Total	C	N	O	P	0	0
			55643	24727	10311	18012	2593		

- Molecule 45 is a RNA chain called E-site tRNA.

Mol	Chain	Residues	Atoms					AltConf	Trace
45	Lu	75	Total	C	N	O	P	0	0
			1604	717	298	515	74		

- Molecule 46 is a protein called 40S ribosomal protein SA.

Mol	Chain	Residues	Atoms					AltConf	Trace
46	SA	195	Total	C	N	O	S	0	0
			1556	1001	273	274	8		

- Molecule 47 is a protein called Ribosomal protein S2.

Mol	Chain	Residues	Atoms					AltConf	Trace
47	SB	208	Total	C	N	O	S	0	0
			1604	1020	293	286	5		

- Molecule 48 is a protein called Ribosomal protein S3.

Mol	Chain	Residues	Atoms					AltConf	Trace
48	SC	204	Total	C	N	O	S	0	0
			1614	1018	294	286	16		

- Molecule 49 is a protein called 40S ribosomal protein S3a.

Mol	Chain	Residues	Atoms					AltConf	Trace
			Total	C	N	O	S		
49	SD	223	1803	1141	333	316	13	0	0

- Molecule 50 is a protein called 40S ribosomal protein S4.

Mol	Chain	Residues	Atoms					AltConf	Trace
			Total	C	N	O	S		
50	SE	259	2081	1331	383	355	12	0	0

- Molecule 51 is a protein called Ribosomal protein S5.

Mol	Chain	Residues	Atoms					AltConf	Trace
			Total	C	N	O	S		
51	SF	177	1382	860	261	252	9	0	0

- Molecule 52 is a protein called 40S ribosomal protein S6.

Mol	Chain	Residues	Atoms					AltConf	Trace
			Total	C	N	O	S		
52	SG	226	1785	1120	338	317	10	0	0

- Molecule 53 is a protein called 40S ribosomal protein S7.

Mol	Chain	Residues	Atoms					AltConf	Trace
			Total	C	N	O	S		
53	SH	184	1481	948	258	268	7	0	0

- Molecule 54 is a protein called 40S ribosomal protein S8.

Mol	Chain	Residues	Atoms					AltConf	Trace
			Total	C	N	O	S		
54	SI	163	1280	804	245	228	3	0	0

- Molecule 55 is a protein called Ribosomal protein S15A.

Mol	Chain	Residues	Atoms					AltConf	Trace
			Total	C	N	O	S		
55	SJ	129	1031	659	192	177	3	0	0

- Molecule 56 is a protein called Ribosomal protein S9.

Mol	Chain	Residues	Atoms					AltConf	Trace
56	SK	175	Total	C	N	O	S	0	0
			1416	884	280	246	6		

- Molecule 57 is a protein called Ribosomal protein S10B.

Mol	Chain	Residues	Atoms					AltConf	Trace
57	SL	101	Total	C	N	O	S	0	0
			827	535	139	149	4		

- Molecule 58 is a protein called Ribosomal protein S11.

Mol	Chain	Residues	Atoms					AltConf	Trace
58	SM	147	Total	C	N	O	S	0	0
			1220	775	239	200	6		

- Molecule 59 is a protein called Ribosomal protein S23.

Mol	Chain	Residues	Atoms					AltConf	Trace
59	SO	136	Total	C	N	O	S	0	0
			1056	669	209	175	3		

- Molecule 60 is a protein called Ribosomal protein S13.

Mol	Chain	Residues	Atoms					AltConf	Trace
60	SP	149	Total	C	N	O	S	0	0
			1187	755	227	200	5		

- Molecule 61 is a protein called Ribosomal protein S14.

Mol	Chain	Residues	Atoms					AltConf	Trace
61	SQ	124	Total	C	N	O	S	0	0
			911	561	188	159	3		

- Molecule 62 is a protein called Ribosomal protein S15.

Mol	Chain	Residues	Atoms					AltConf	Trace
62	SR	112	Total	C	N	O	S	0	0
			912	582	178	144	8		

- Molecule 63 is a protein called Ribosomal protein S16.

Mol	Chain	Residues	Atoms					AltConf	Trace
63	ST	151	Total	C	N	O	S	0	0
			1180	736	229	212	3		

- Molecule 64 is a protein called Ribosomal protein S17.

Mol	Chain	Residues	Atoms					AltConf	Trace
64	SU	66	Total	C	N	O	S	0	0
			526	329	106	89	2		

There is a discrepancy between the modelled and reference sequences:

Chain	Residue	Modelled	Actual	Comment	Reference
SU	104	THR	ALA	conflict	UNP A8BRG5

- Molecule 65 is a protein called Ribosomal protein S18.

Mol	Chain	Residues	Atoms					AltConf	Trace
65	SV	140	Total	C	N	O	S	0	0
			1113	685	226	196	6		

- Molecule 66 is a protein called Ribosomal protein S19e.

Mol	Chain	Residues	Atoms					AltConf	Trace
66	SW	138	Total	C	N	O	S	0	0
			1080	686	204	187	3		

- Molecule 67 is a protein called Ribosomal protein S20.

Mol	Chain	Residues	Atoms					AltConf	Trace
67	SX	102	Total	C	N	O	S	0	0
			811	516	147	143	5		

- Molecule 68 is a protein called 40S ribosomal protein S21.

Mol	Chain	Residues	Atoms					AltConf	Trace
68	SY	82	Total	C	N	O	S	0	0
			615	383	113	113	6		

- Molecule 69 is a protein called Ribosomal protein S24.

Mol	Chain	Residues	Atoms					AltConf	Trace
69	Sb	118	Total	C	N	O	S	0	0
			941	598	177	160	6		

- Molecule 70 is a protein called 40S ribosomal protein S25.

Mol	Chain	Residues	Atoms					AltConf	Trace
70	Sc	71	Total	C	N	O	S	0	0
			561	353	103	99	6		

- Molecule 71 is a protein called 40S ribosomal protein S26.

Mol	Chain	Residues	Atoms					AltConf	Trace
71	Sd	98	Total	C	N	O	S	0	0
			796	491	164	134	7		

- Molecule 72 is a protein called Ribosomal protein S27.

Mol	Chain	Residues	Atoms					AltConf	Trace
72	Se	80	Total	C	N	O	S	0	0
			629	397	110	116	6		

- Molecule 73 is a protein called Ribosomal protein S28.

Mol	Chain	Residues	Atoms					AltConf	Trace
73	Sg	60	Total	C	N	O	S	0	0
			474	293	91	88	2		

- Molecule 74 is a protein called Ribosomal protein S29A.

Mol	Chain	Residues	Atoms					AltConf	Trace
74	Sh	49	Total	C	N	O	S	0	0
			409	259	79	66	5		

- Molecule 75 is a protein called 40S ribosomal protein S30.

Mol	Chain	Residues	Atoms					AltConf	Trace
75	Sj	64	Total	C	N	O	S	0	0
			525	331	109	84	1		

- Molecule 76 is a RNA chain called Small Subunit rRNA.

Mol	Chain	Residues	Atoms					AltConf	Trace
			Total	C	N	O	P		
76	St	1454	31176	13861	5772	10090	1453	0	0

- Molecule 77 is a protein called Elongation factor 2.

Mol	Chain	Residues	Atoms					AltConf	Trace
			Total	C	N	O	S		
77	a	815	6343	3998	1097	1203	45	0	0

- Molecule 78 is a RNA chain called mRNA.

Mol	Chain	Residues	Atoms					AltConf	Trace
			Total	C	N	O	P		
78	y	11	240	108	49	72	11	0	0

- Molecule 79 is PHOSPHATE ION (three-letter code: PO4) (formula: O₄P) (labeled as "Ligand of Interest" by depositor).

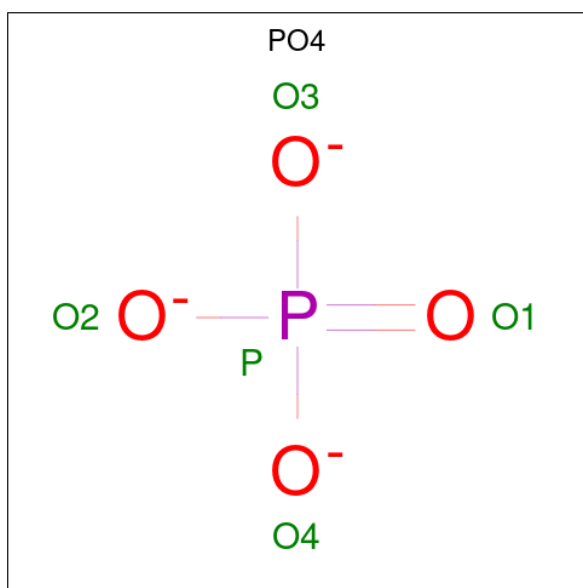

Mol	Chain	Residues	Atoms			AltConf
			Total	O	P	
79	a	1	5	4	1	0

- Molecule 80 is GUANOSINE-5'-DIPHOSPHATE (three-letter code: GDP) (formula: C₁₀H₁₅N₅O₁₁P₂) (labeled as "Ligand of Interest" by depositor).

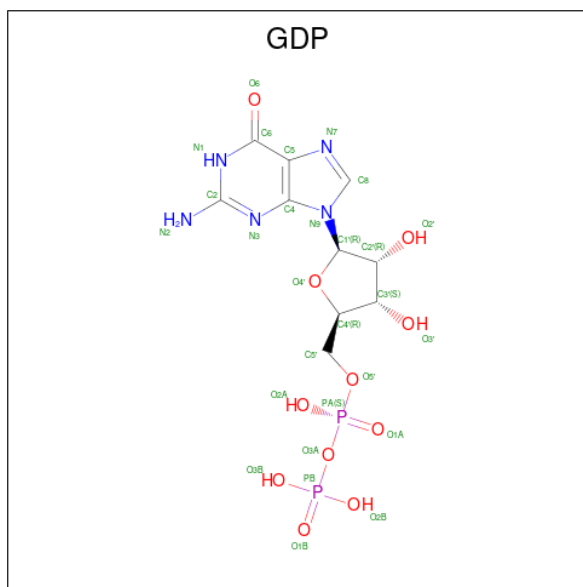

Mol	Chain	Residues	Atoms					AltConf
			Total	C	N	O	P	
80	a	1	28	10	5	11	2	0

3 Residue-property plots [i](#)

These plots are drawn for all protein, RNA, DNA and oligosaccharide chains in the entry. The first graphic for a chain summarises the proportions of the various outlier classes displayed in the second graphic. The second graphic shows the sequence view annotated by issues in geometry and atom inclusion in map density. Residues are color-coded according to the number of geometric quality criteria for which they contain at least one outlier: green = 0, yellow = 1, orange = 2 and red = 3 or more. A red diamond above a residue indicates a poor fit to the EM map for this residue (all-atom inclusion < 40%). Stretches of 2 or more consecutive residues without any outlier are shown as a green connector. Residues present in the sample, but not in the model, are shown in grey.

- Molecule 1: Ribosomal protein L2

Chain LA:  80% 17%

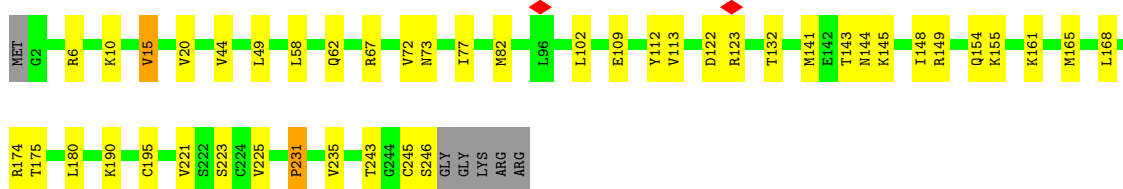

- Molecule 2: Ribosomal protein L3

Chain LB:  79% 18%

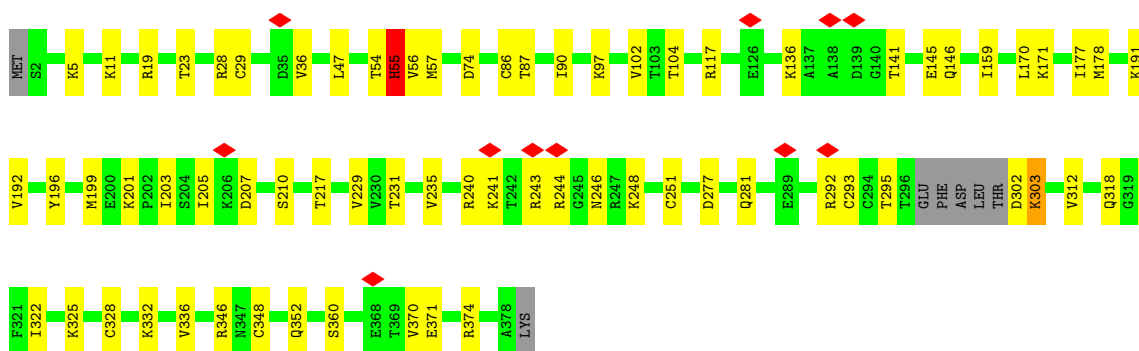

- Molecule 3: Ribosomal protein L4

Chain LC:  7% 79% 18%

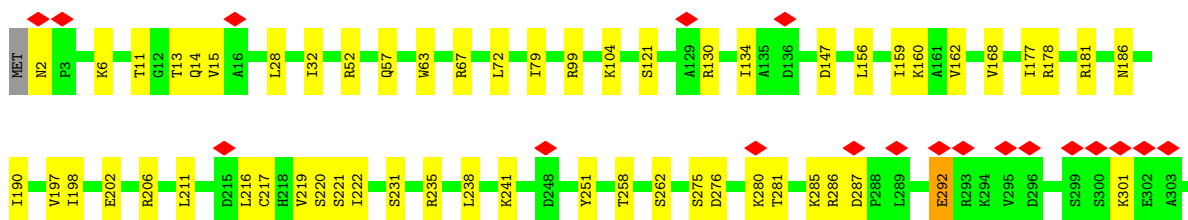

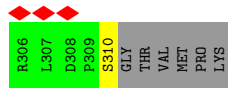

• Molecule 4: 5.8S rRNA

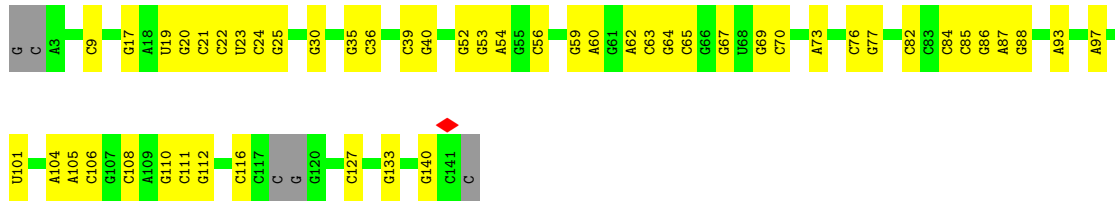

• Molecule 5: 5S rRNA

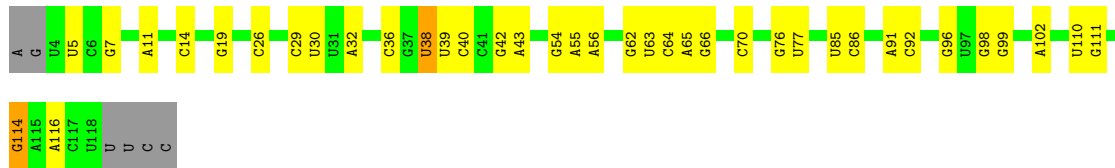

• Molecule 6: Ribosomal protein L5

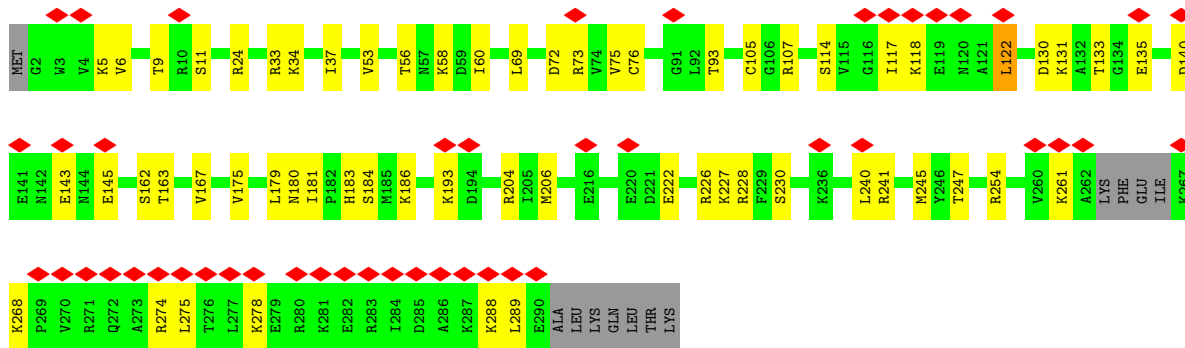
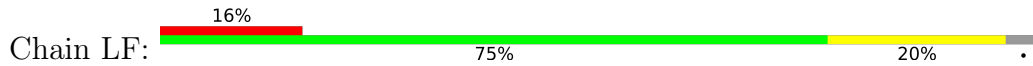

• Molecule 7: Ribosomal protein L39

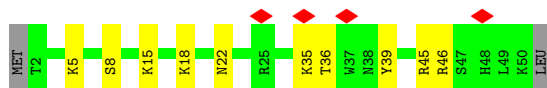
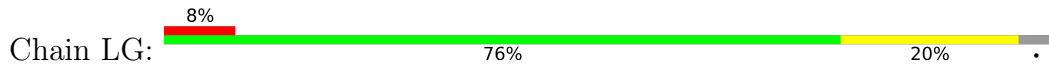

• Molecule 8: Ribosomal protein L7

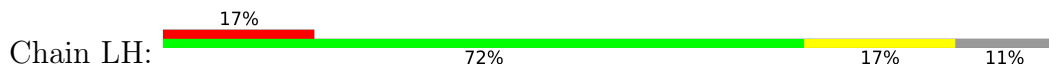

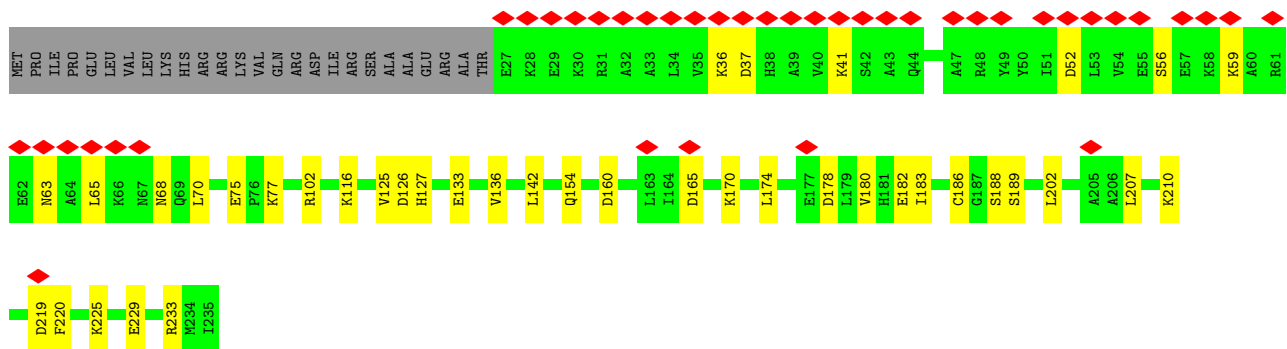

• Molecule 9: 60S ribosomal protein L7a

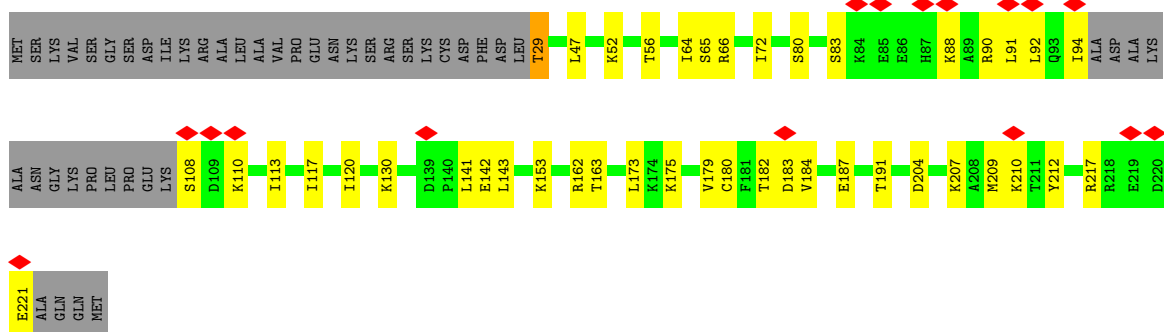

• Molecule 10: Ribosomal protein L6

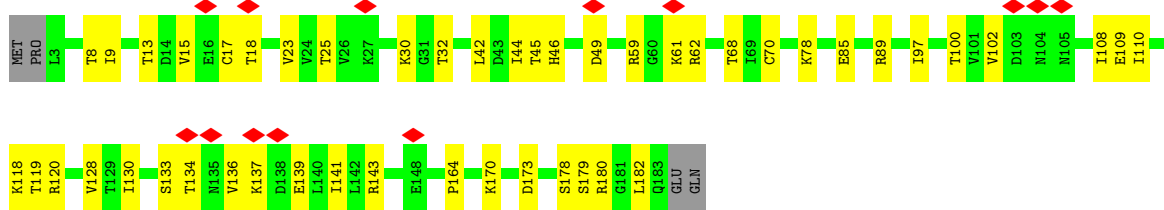

• Molecule 11: Ribosomal protein L10

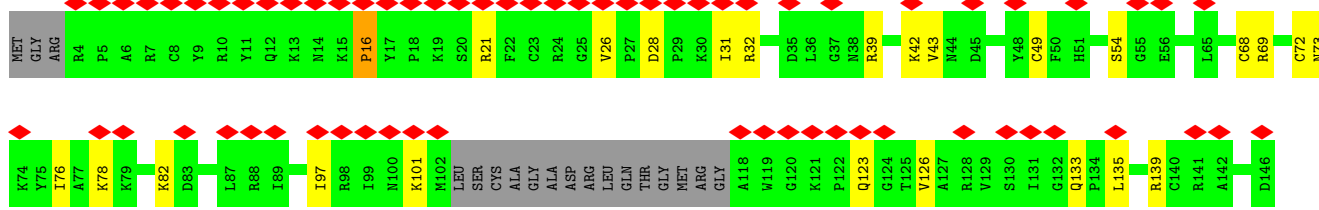

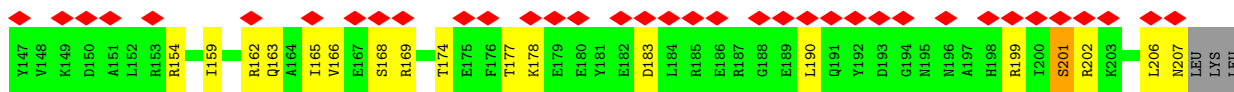

• Molecule 12: Ribosomal protein L11

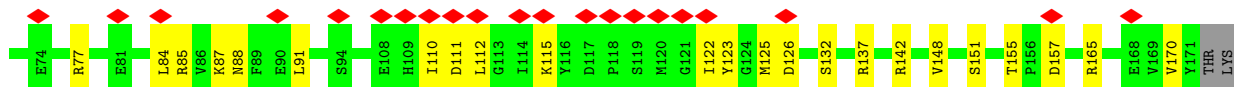
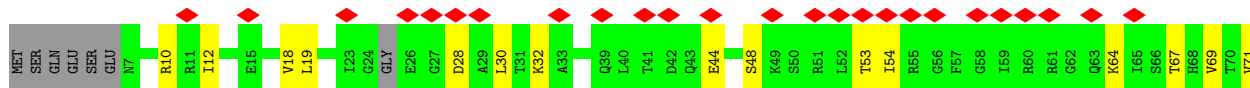
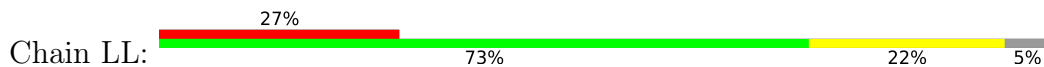

• Molecule 13: 60S ribosomal protein L13

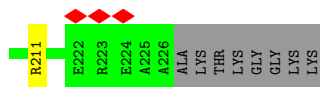
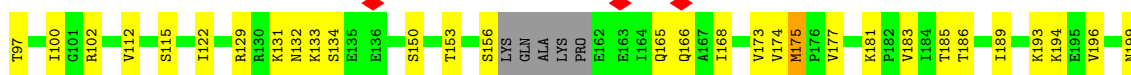

• Molecule 14: Ribosomal protein L14

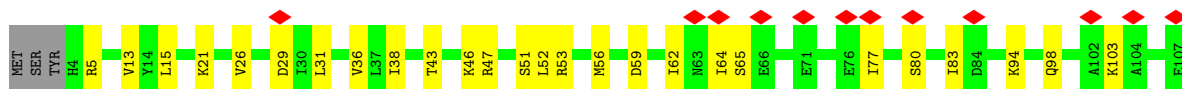
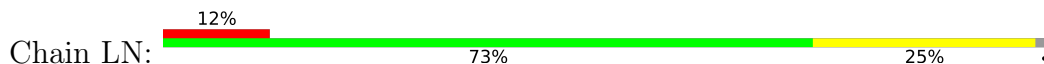

• Molecule 15: Ribosomal protein L15

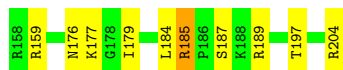
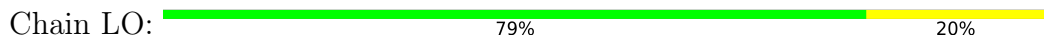

• Molecule 16: Ribosomal protein L13a

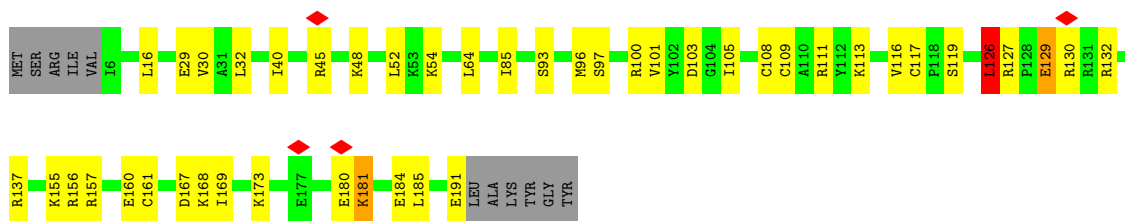

• Molecule 17: Ribosomal protein L17

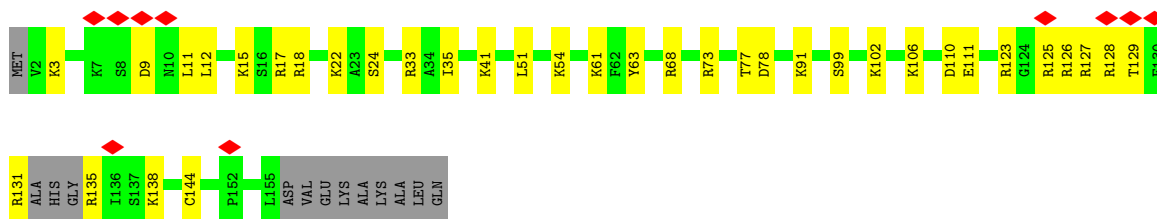

• Molecule 18: Ribosomal protein L18

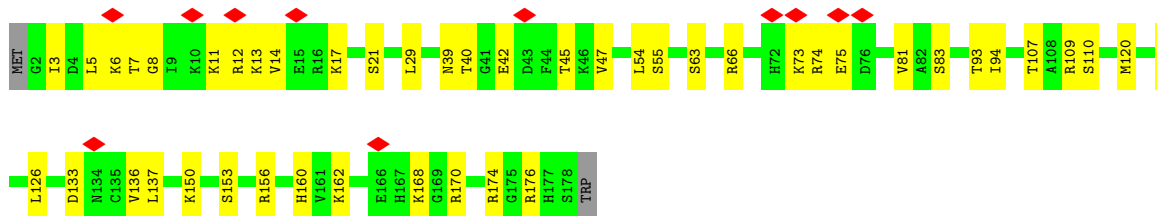
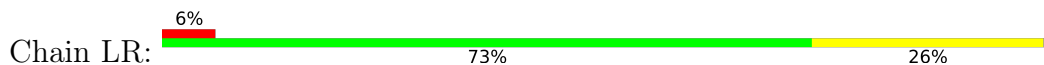

• Molecule 19: Ribosomal protein L19

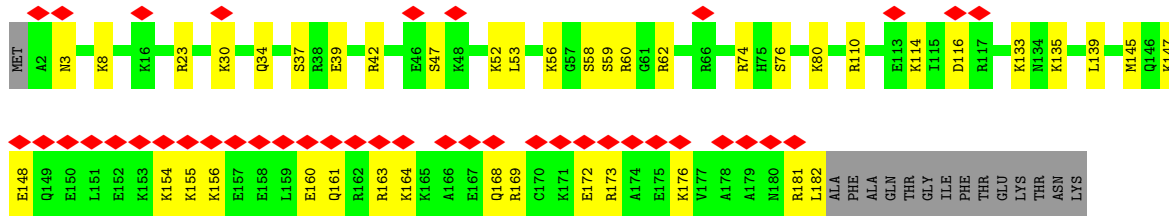

• Molecule 20: 60S ribosomal protein L18a

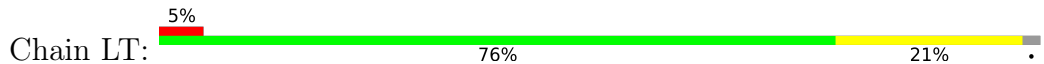

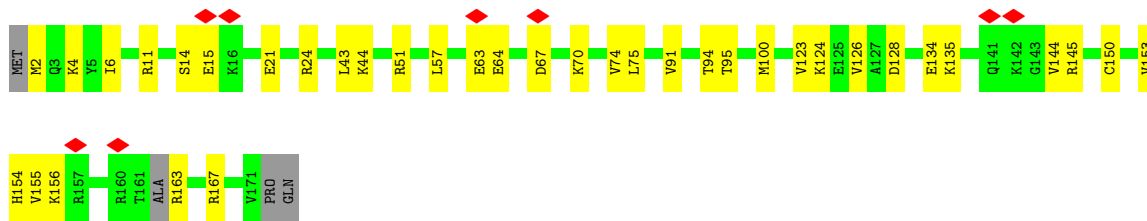

• Molecule 21: Ribosomal protein L21

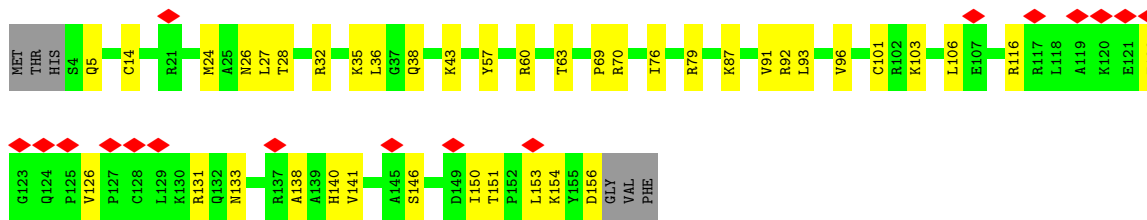
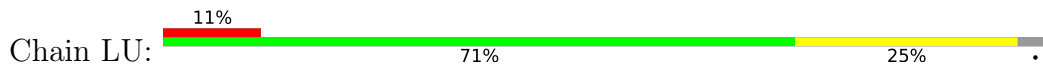

• Molecule 22: Ribosomal L22e

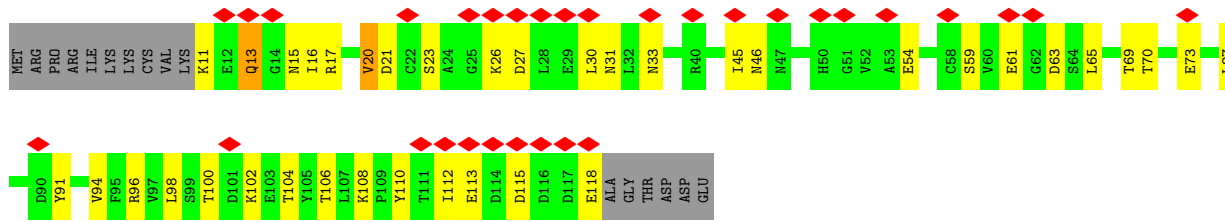

• Molecule 23: Ribosomal protein L23

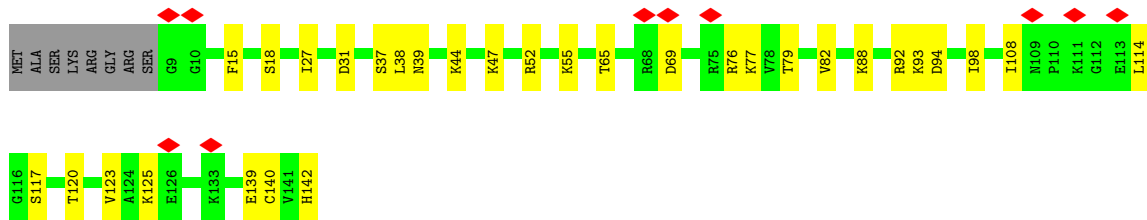
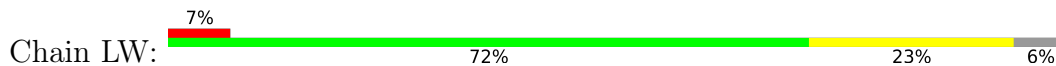

• Molecule 24: Ribosomal protein L24

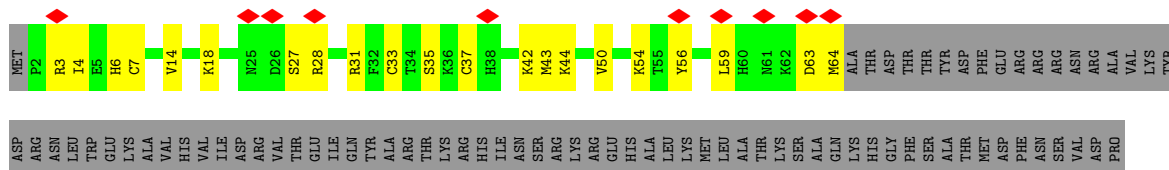

LEU GLN MET LYS ALA VAL GLU LYS VAL ARG MET LYS LYS LYS ILE LYS GLU ARG PRO TYR ARG PRO ILE LYS ARG GLN LYS ILE ALA ARG VAL ASP SER GLU VAL LYS GLN PRO VAL

• Molecule 25: Ribosomal protein L23A

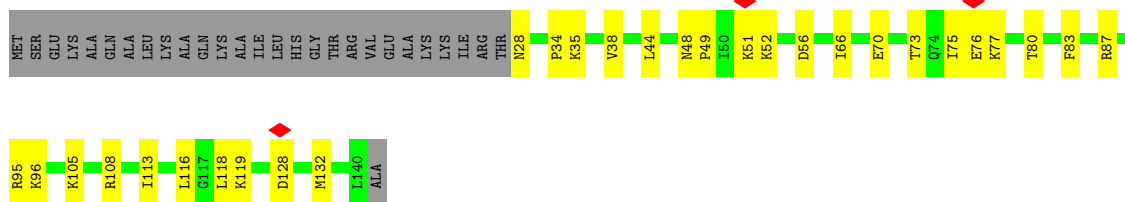

• Molecule 26: Ribosomal protein L26

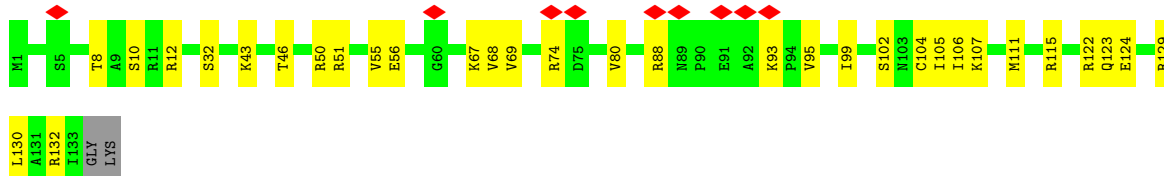
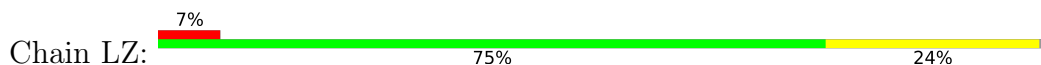

• Molecule 27: 60S ribosomal protein L27

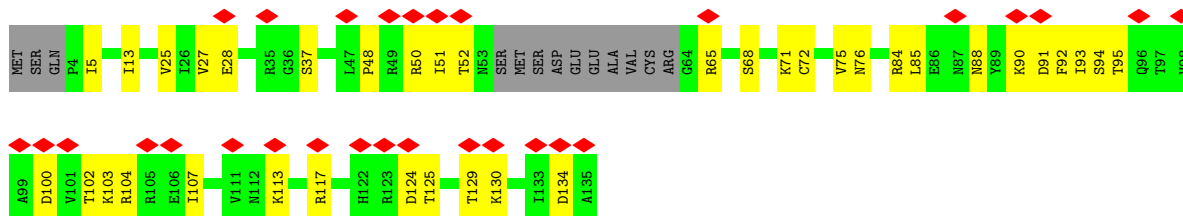

• Molecule 28: Ribosomal protein L27a

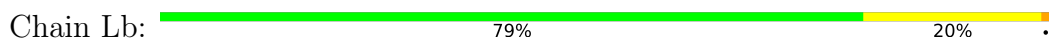

• Molecule 29: 60S ribosomal protein L29



• Molecule 30: Ribosomal protein L30

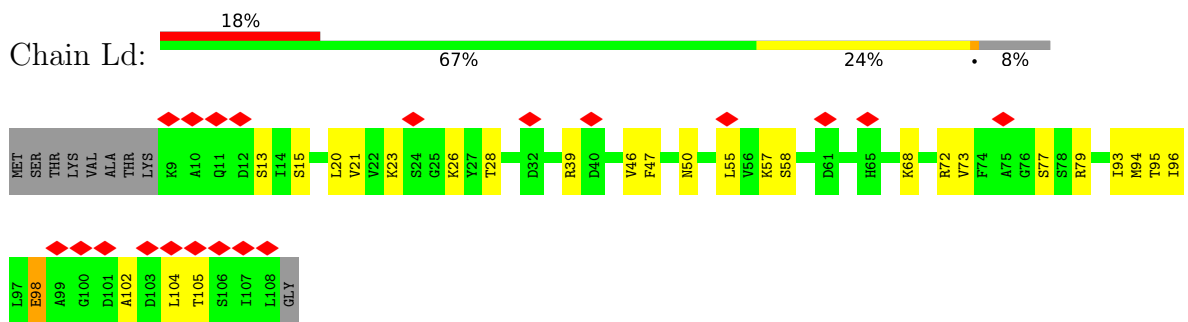

• Molecule 31: Ribosomal protein L31B

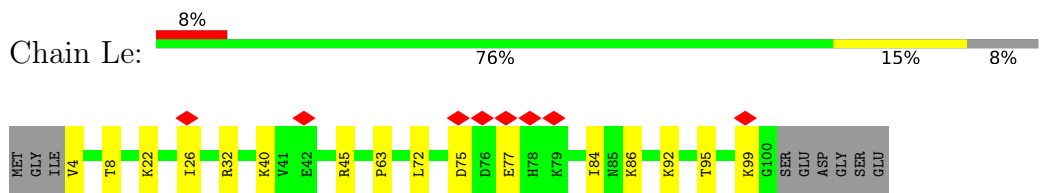

• Molecule 32: Ribosomal protein L32

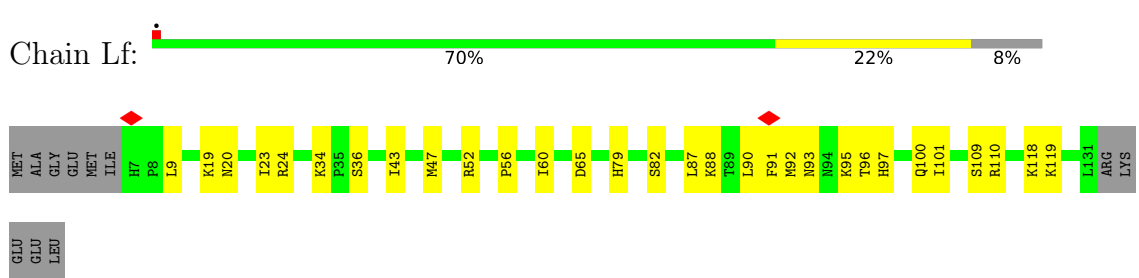

• Molecule 33: Ribosomal protein L35a

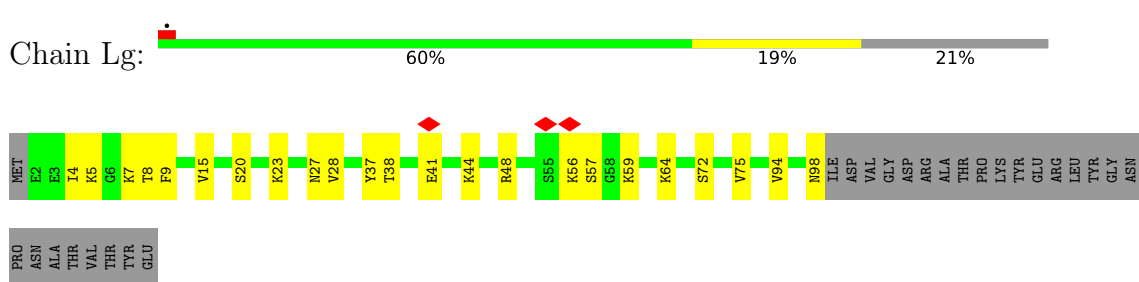

• Molecule 34: Ribosomal protein L34

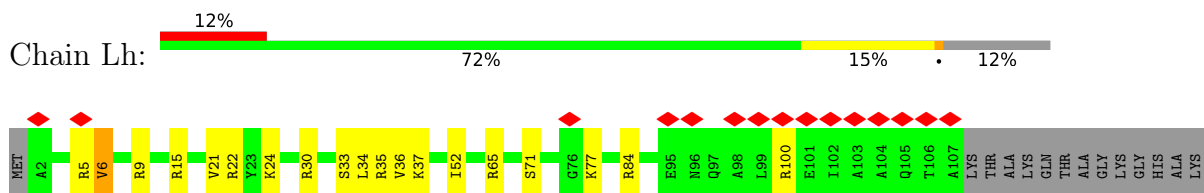

• Molecule 35: Ribosomal protein L29



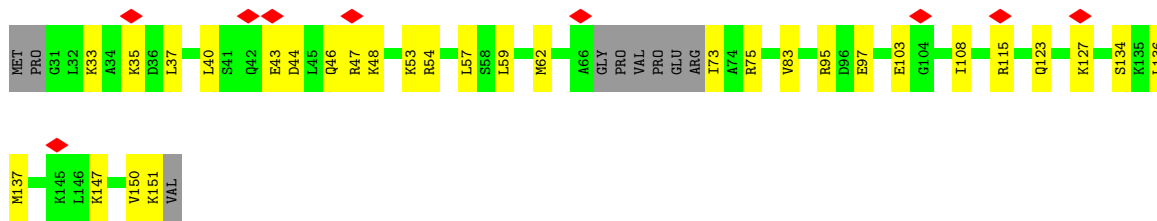

• Molecule 36: Ribosomal protein L36-1



• Molecule 37: Ribosomal protein L37

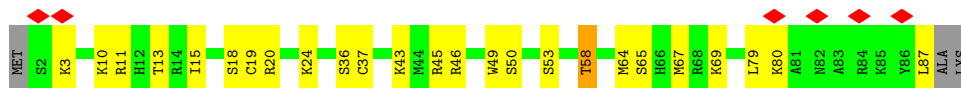

• Molecule 38: Ribosomal L38e

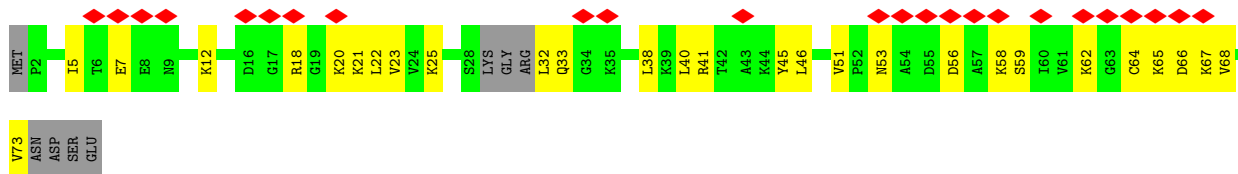

• Molecule 39: Ribosomal protein L10a

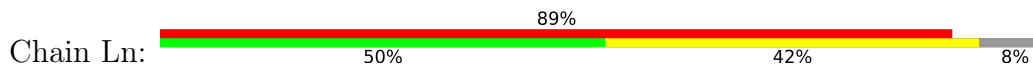

• Molecule 40: 60S ribosomal protein L41

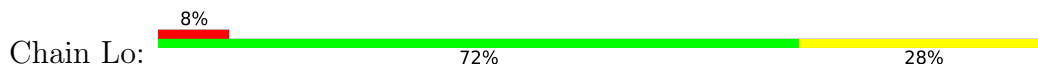

• Molecule 41: Ribosomal protein L44

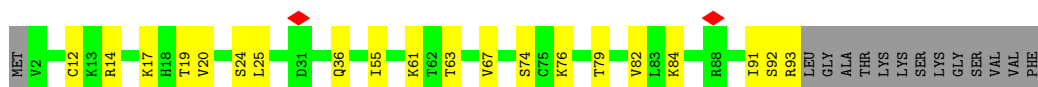

• Molecule 42: Ribosomal protein L37a

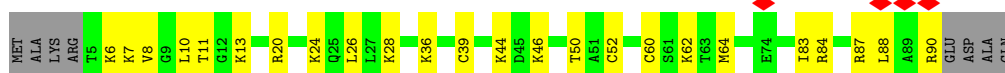

• Molecule 43: Ubiquitin/Ribosomal protein L40e

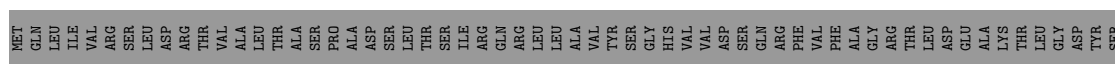

• Molecule 44: Large Subunit rRNA

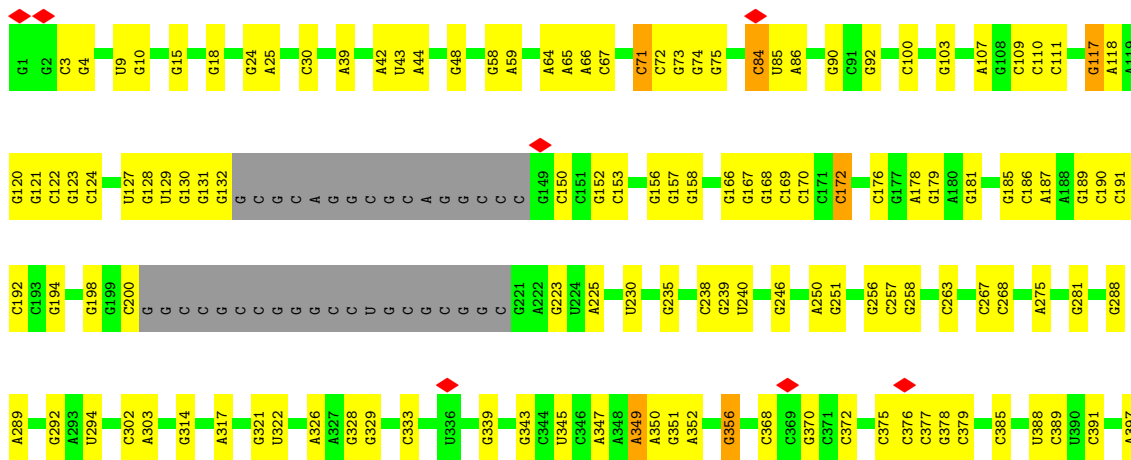

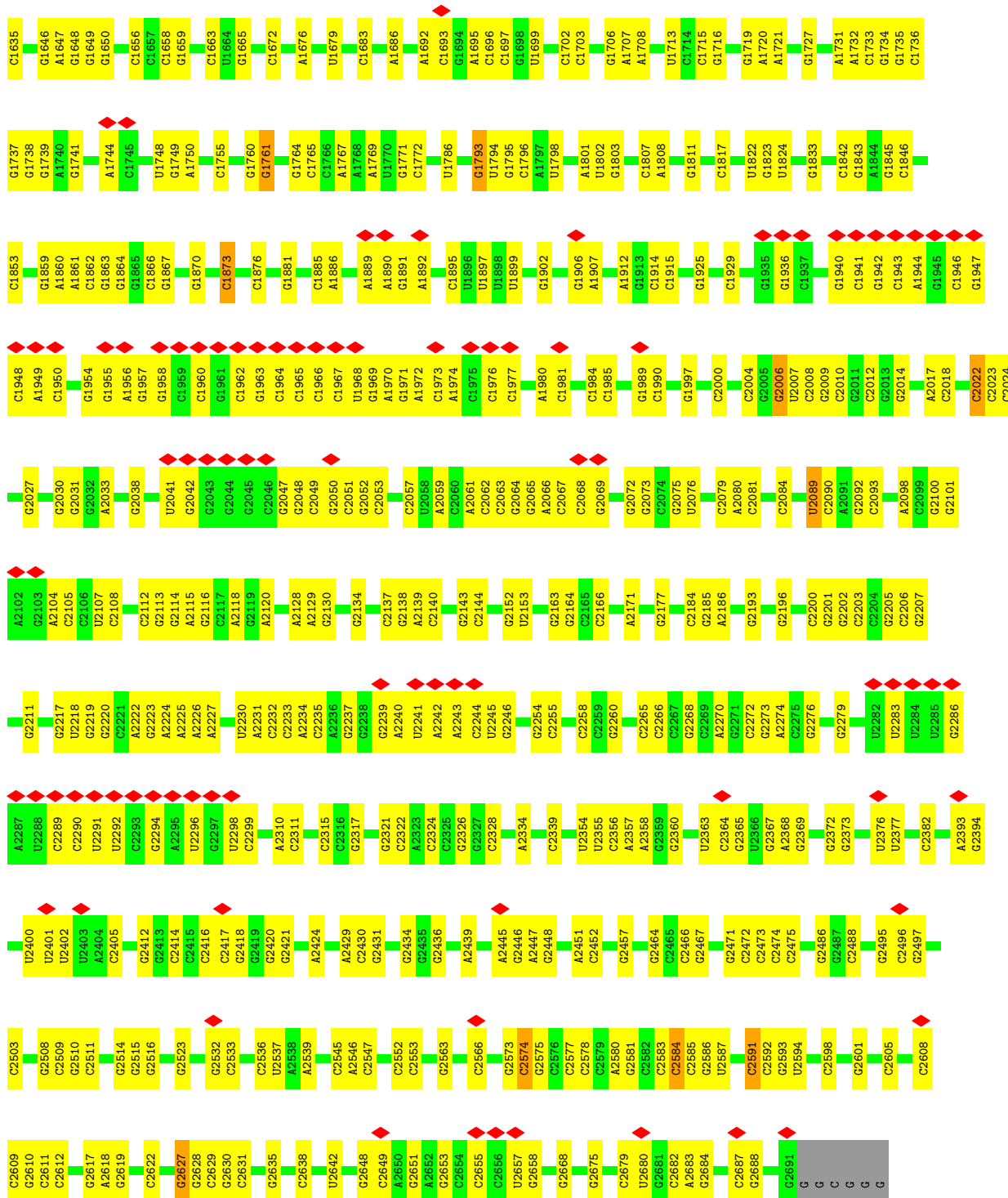

• Molecule 45: E-site tRNA

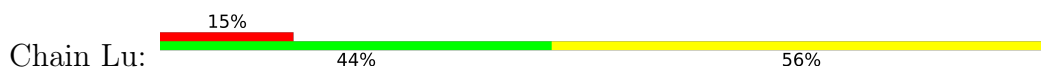

• Molecule 46: 40S ribosomal protein SA

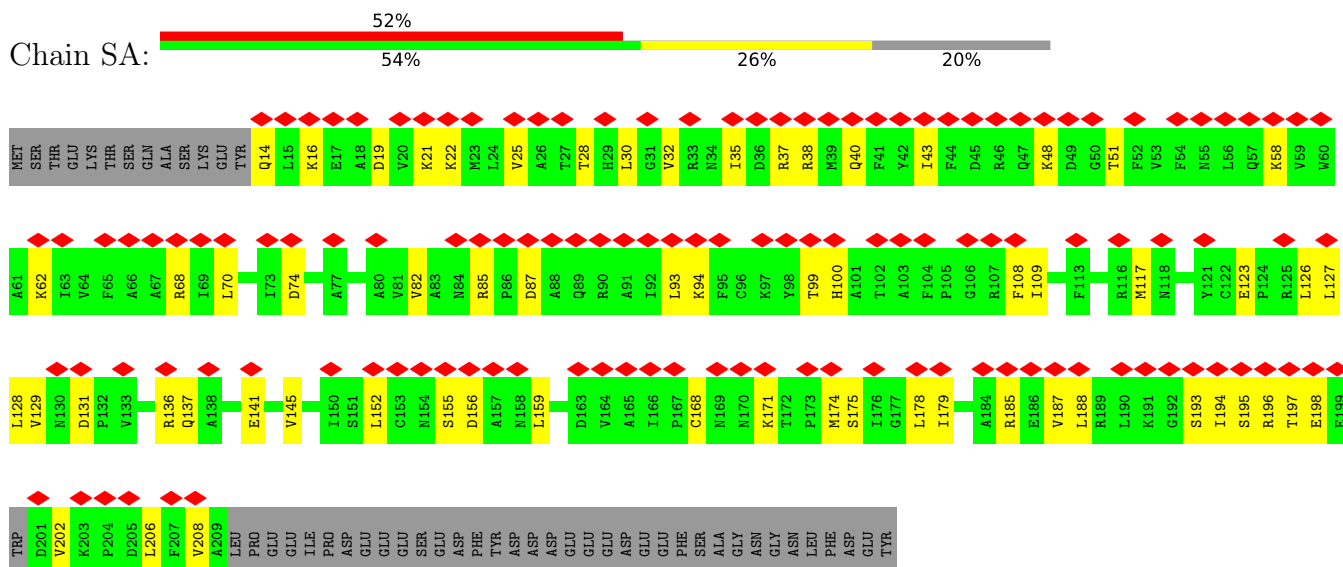

• Molecule 47: Ribosomal protein S2

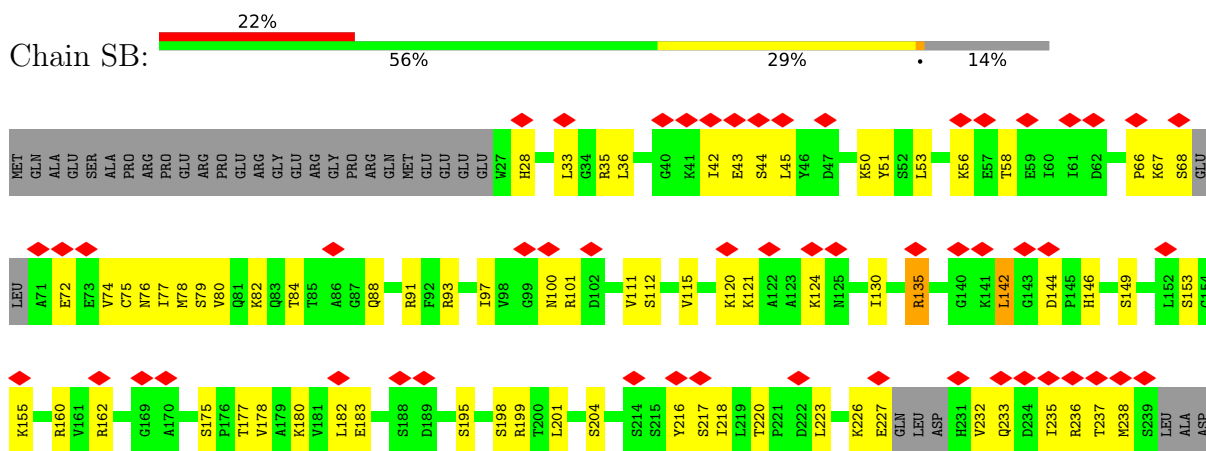

• Molecule 48: Ribosomal protein S3

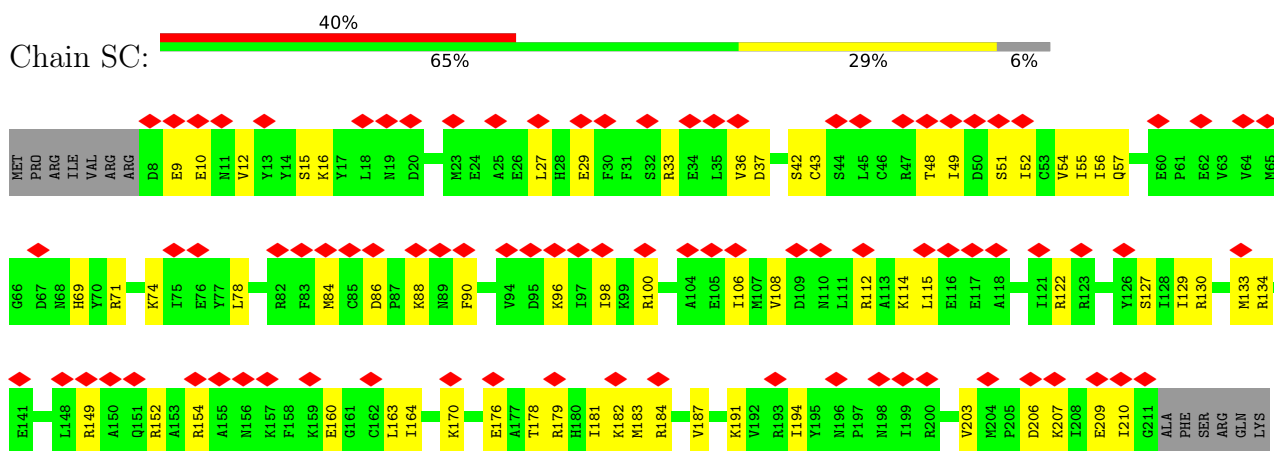

• Molecule 49: 40S ribosomal protein S3a

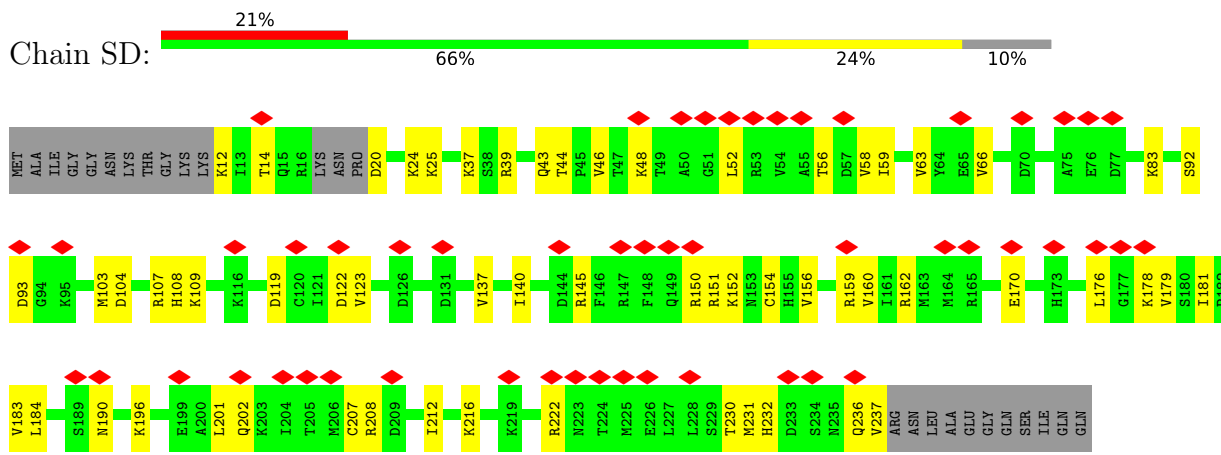

• Molecule 50: 40S ribosomal protein S4

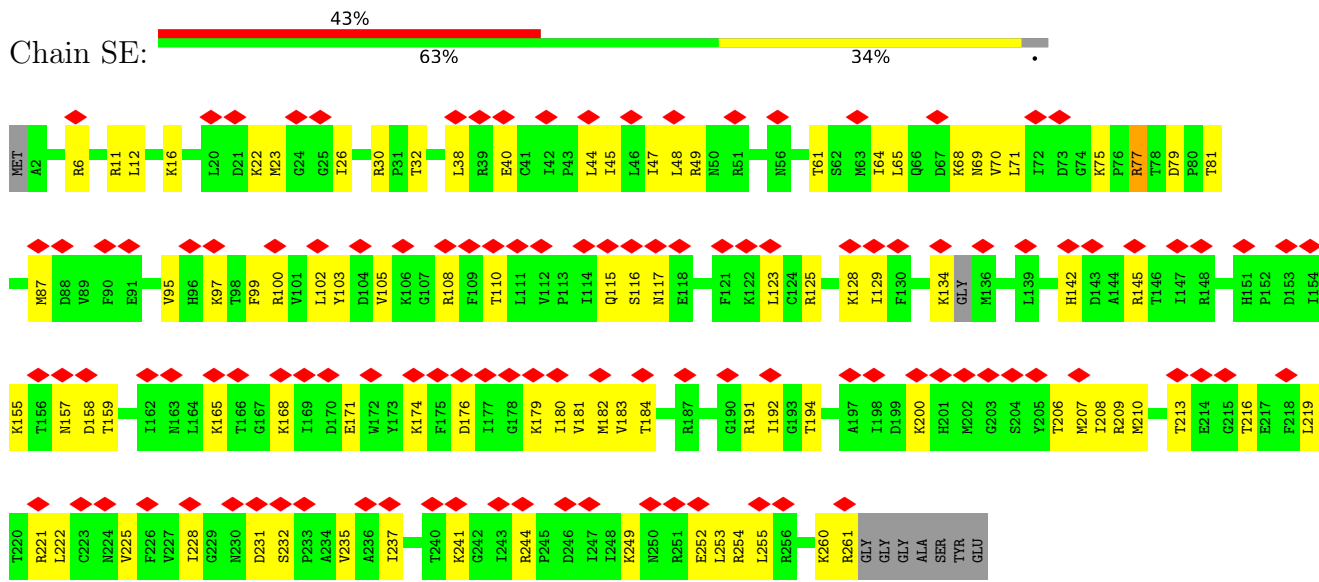

• Molecule 51: Ribosomal protein S5

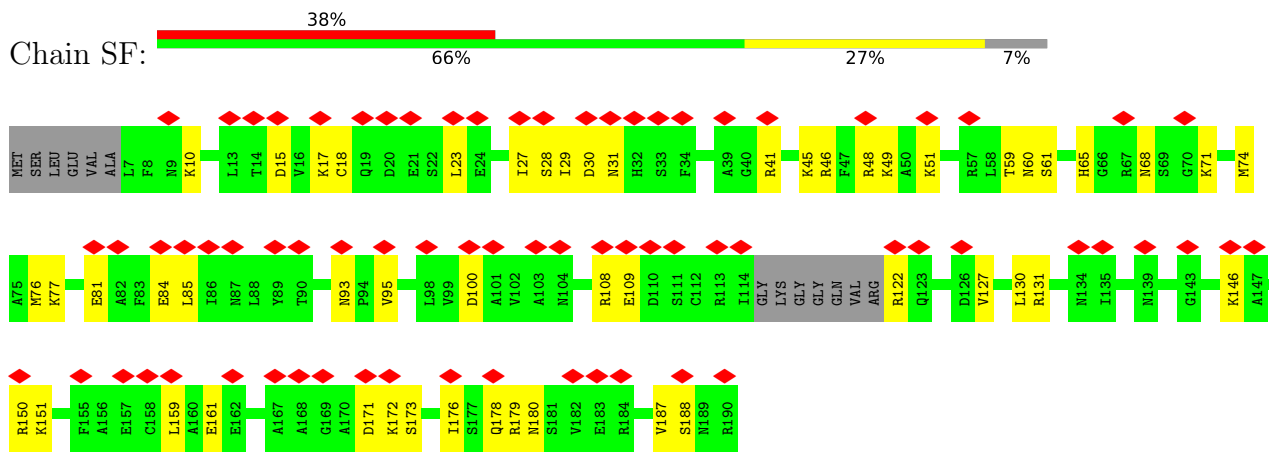

• Molecule 52: 40S ribosomal protein S6



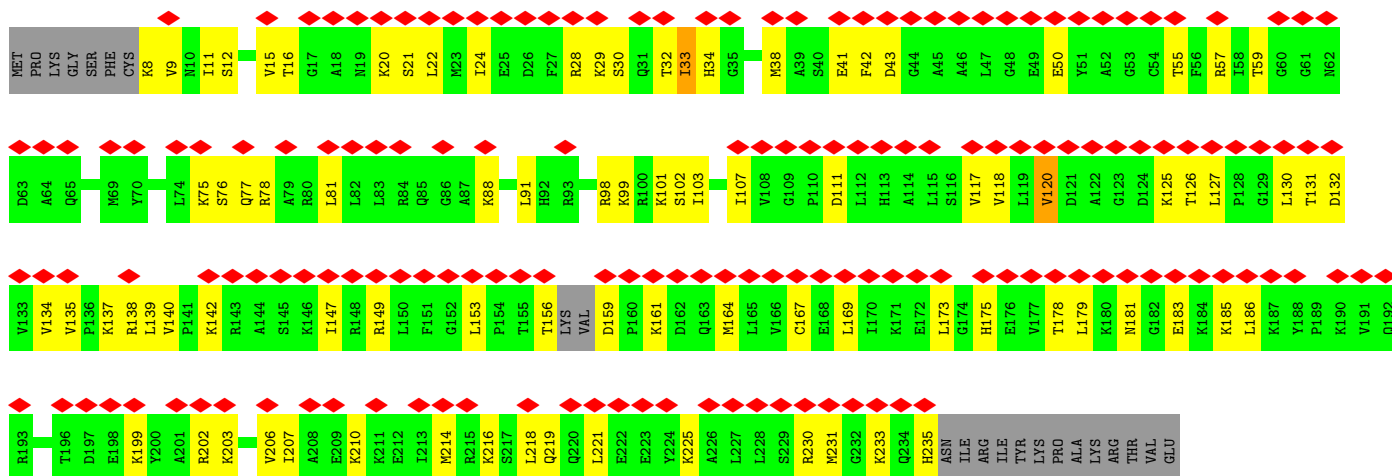

• Molecule 53: 40S ribosomal protein S7

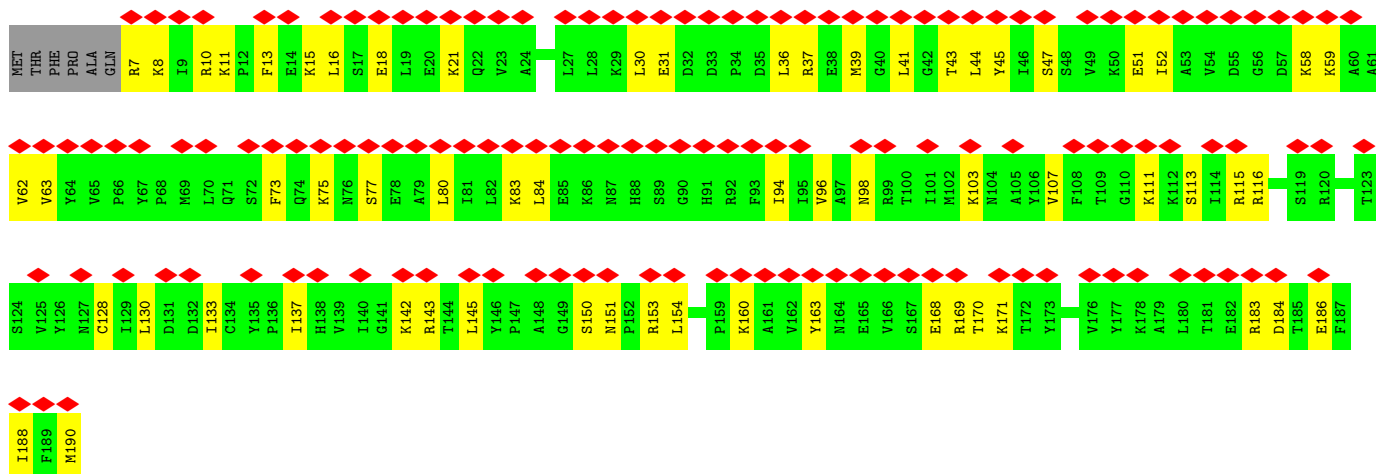
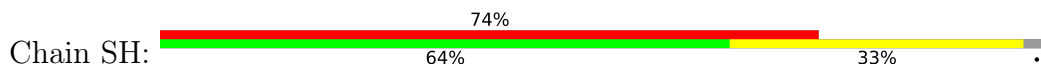

• Molecule 54: 40S ribosomal protein S8

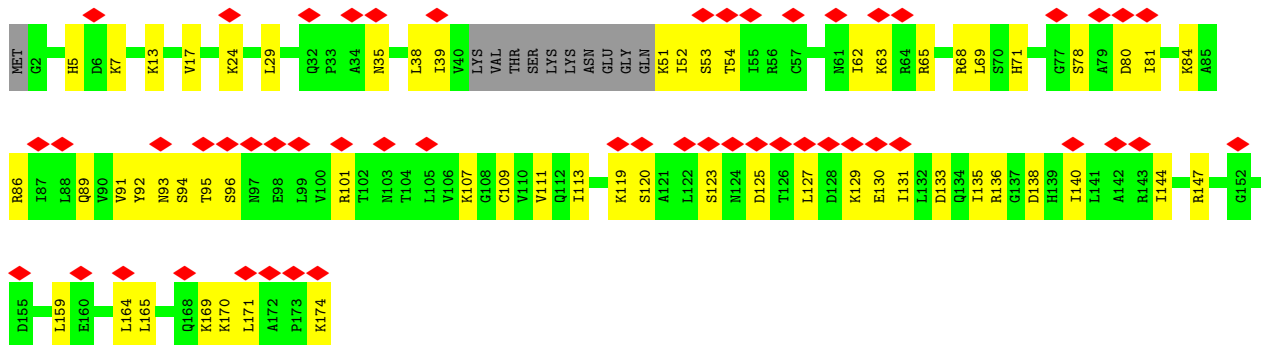

• Molecule 55: Ribosomal protein S15A

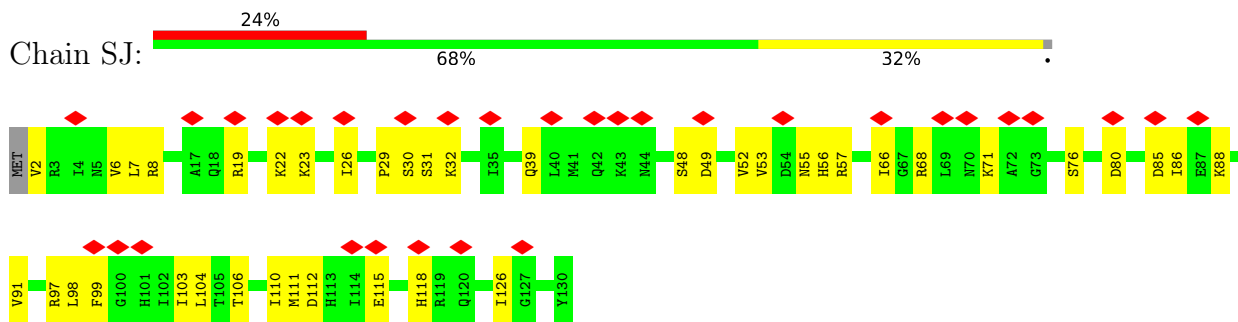

• Molecule 56: Ribosomal protein S9

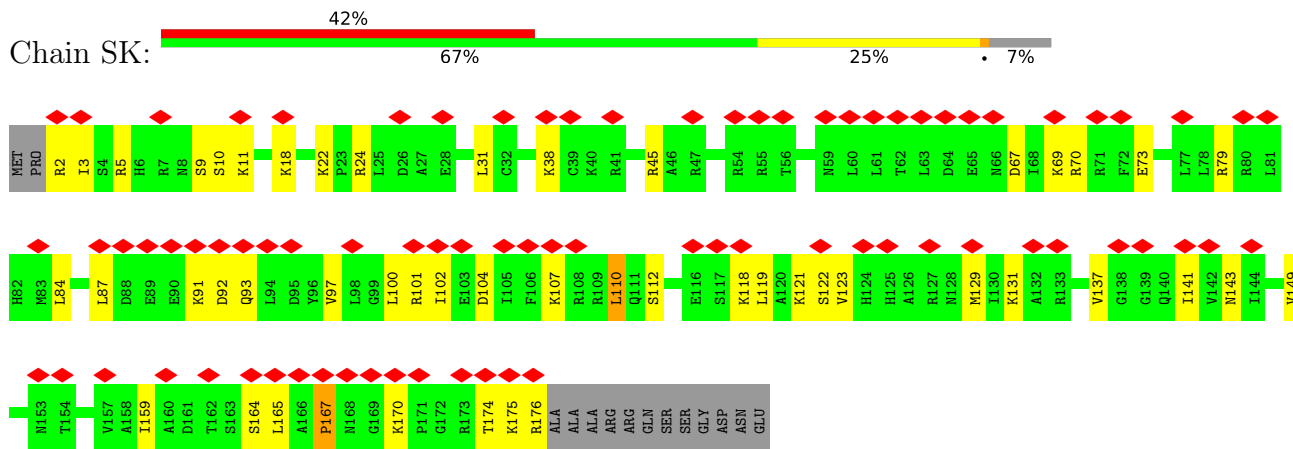

• Molecule 57: Ribosomal protein S10B

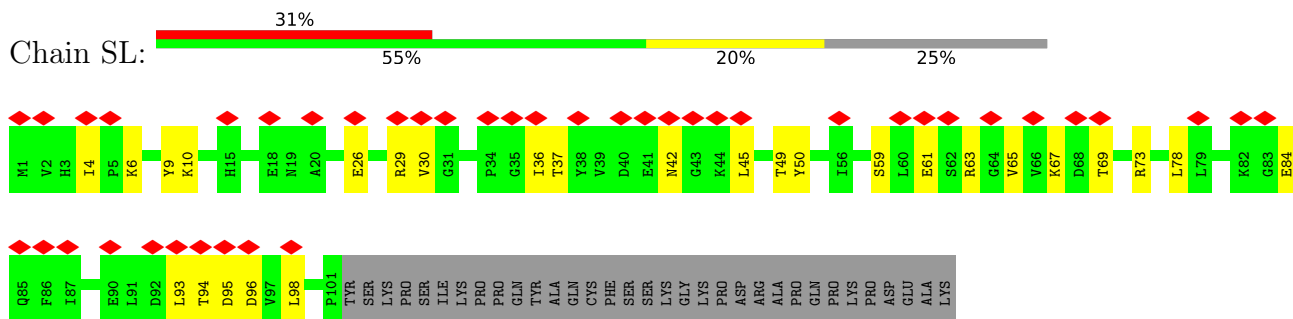

• Molecule 58: Ribosomal protein S11

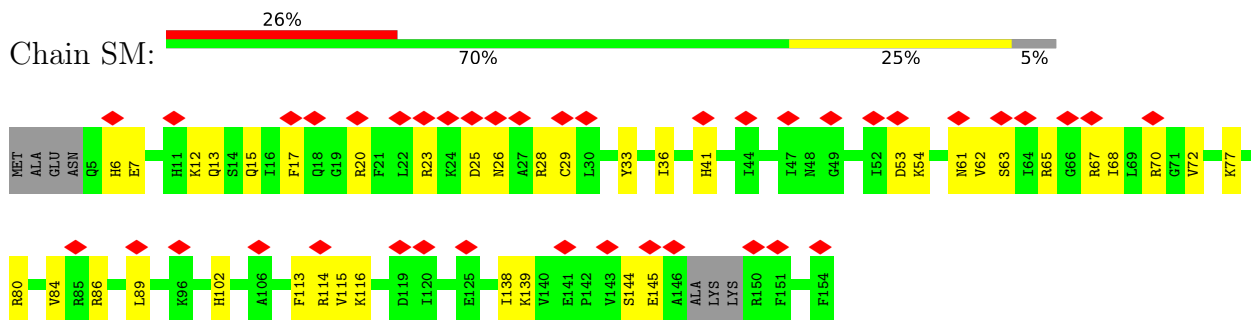

• Molecule 59: Ribosomal protein S23



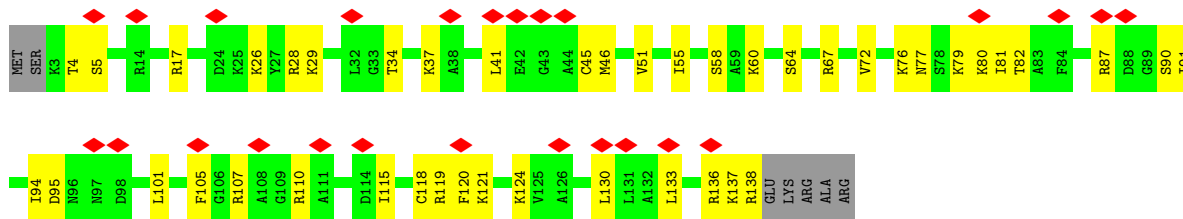

• Molecule 60: Ribosomal protein S13

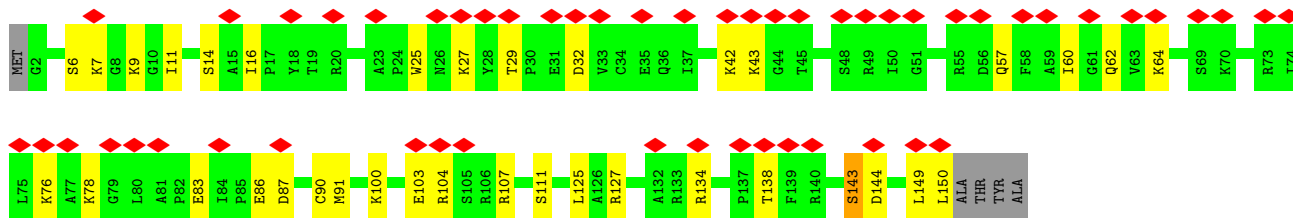
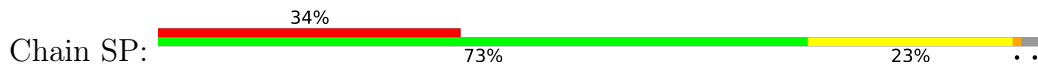

• Molecule 61: Ribosomal protein S14

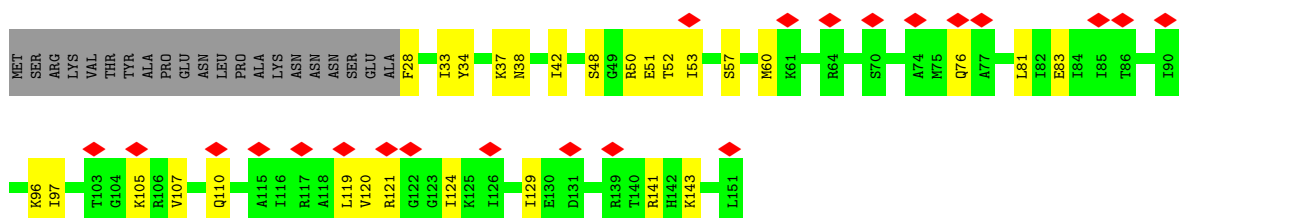

• Molecule 62: Ribosomal protein S15

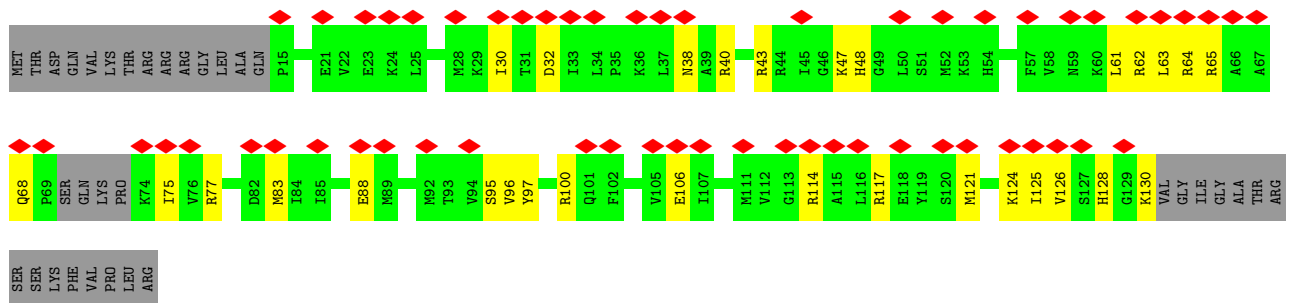
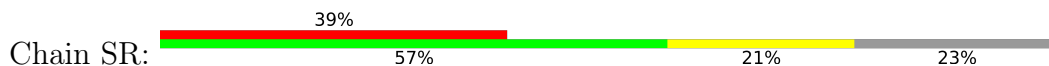

• Molecule 63: Ribosomal protein S16

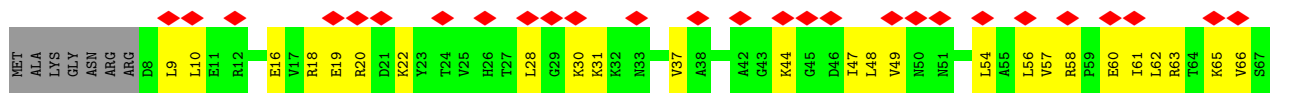

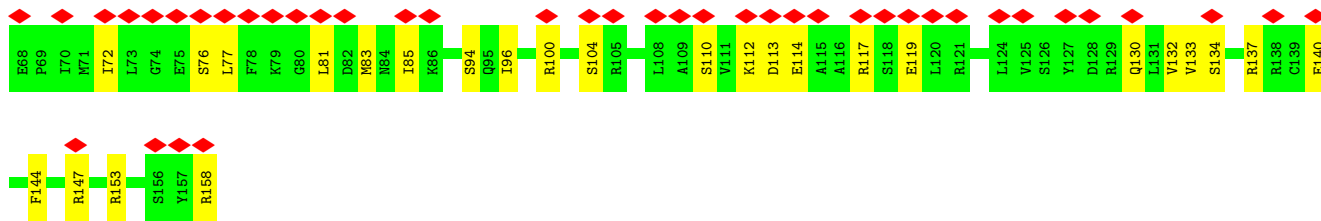

• Molecule 64: Ribosomal protein S17

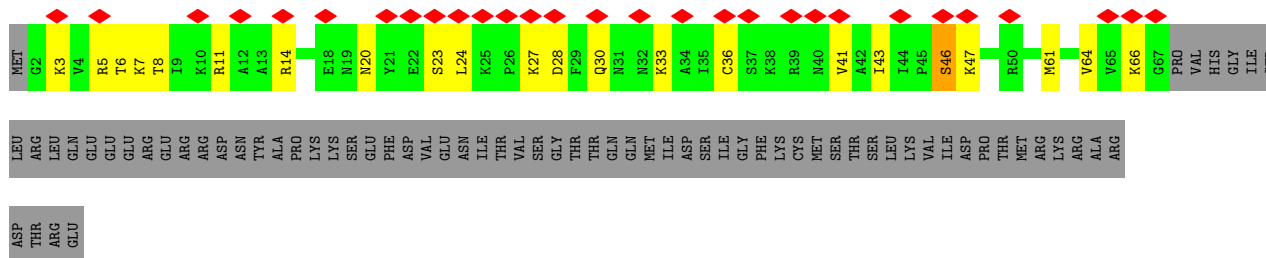
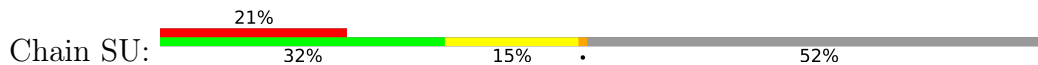

• Molecule 65: Ribosomal protein S18

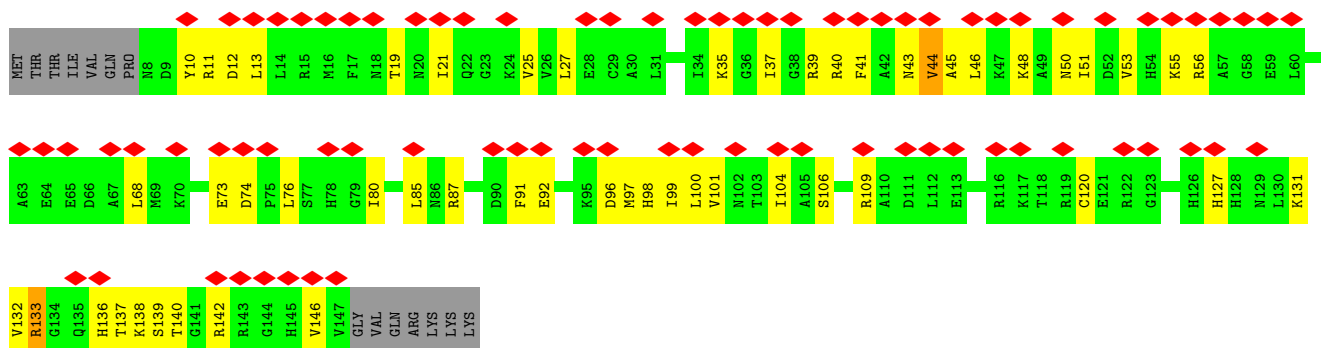

• Molecule 66: Ribosomal protein S19e

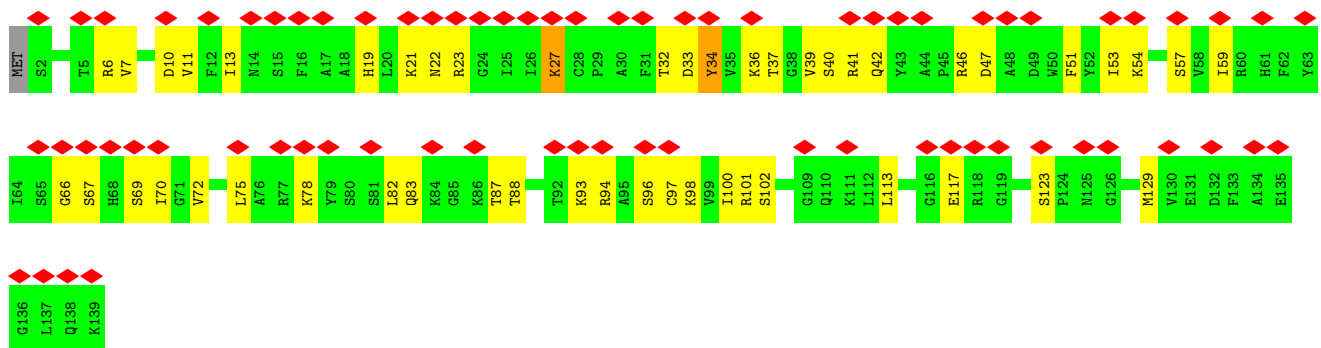

• Molecule 67: Ribosomal protein S20

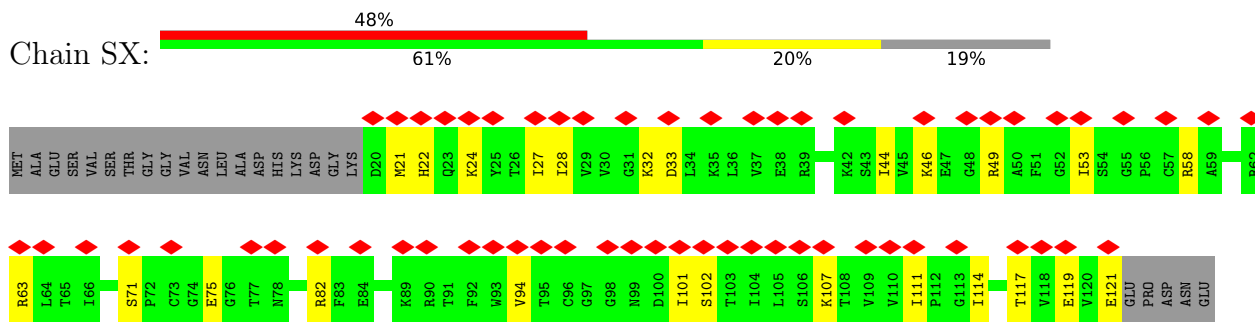

• Molecule 68: 40S ribosomal protein S21

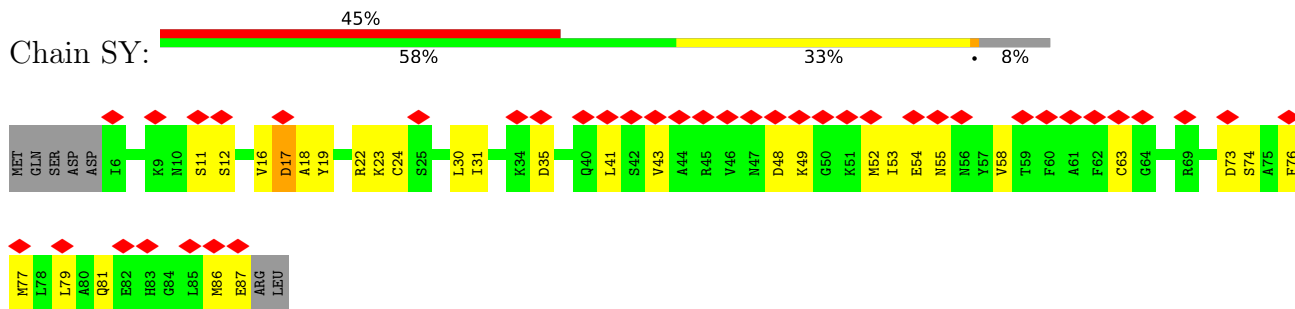

• Molecule 69: Ribosomal protein S24

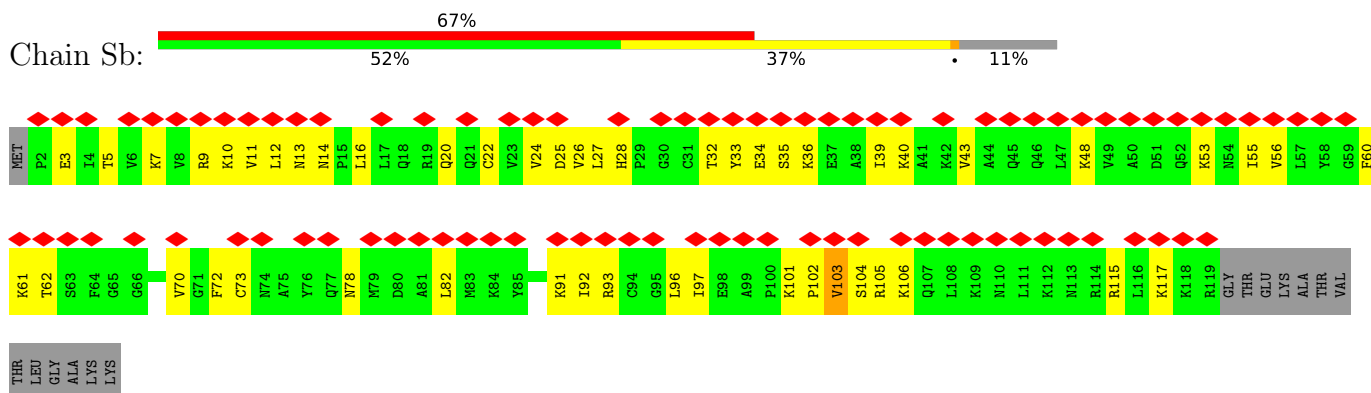

• Molecule 70: 40S ribosomal protein S25

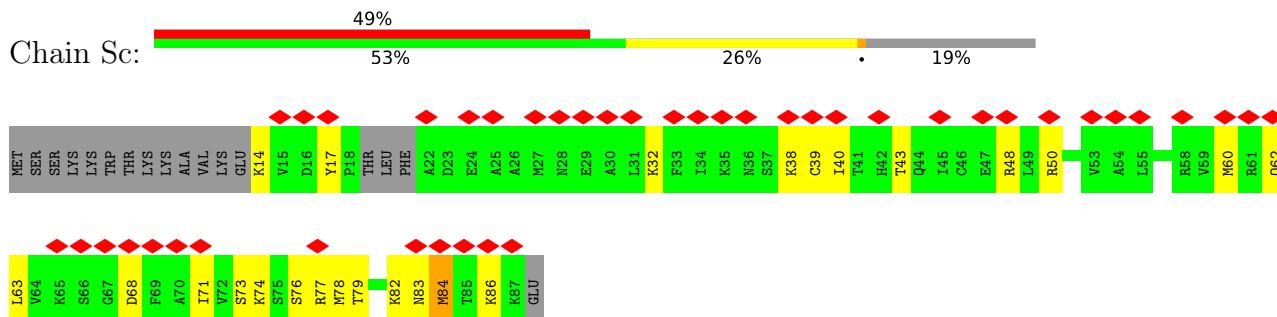

• Molecule 71: 40S ribosomal protein S26



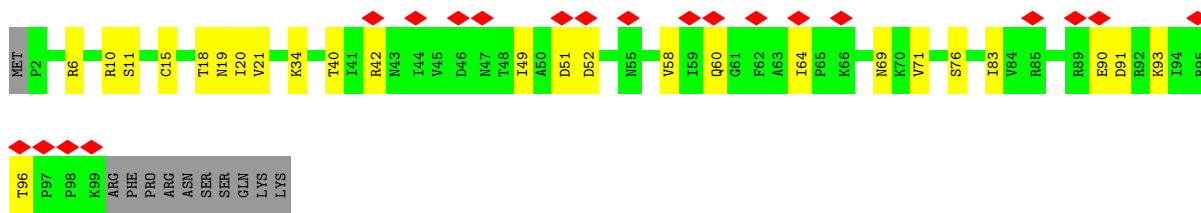

• Molecule 72: Ribosomal protein S27

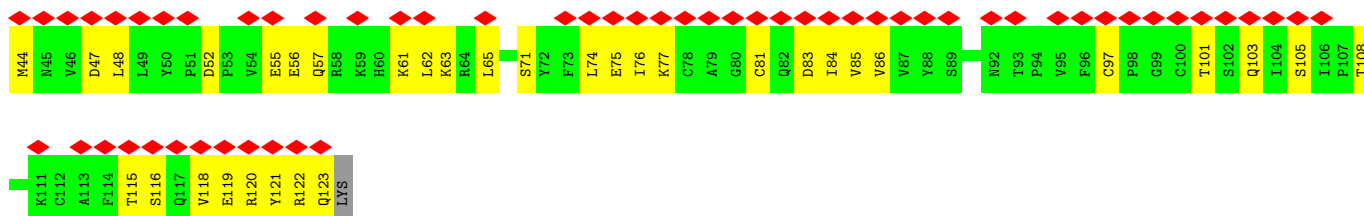
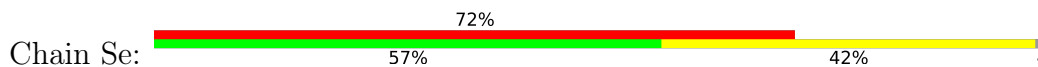

• Molecule 73: Ribosomal protein S28



• Molecule 74: Ribosomal protein S29A

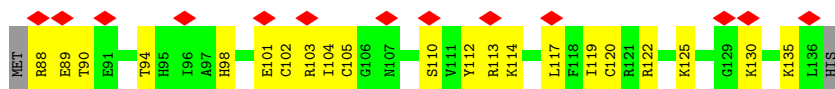

• Molecule 75: 40S ribosomal protein S30

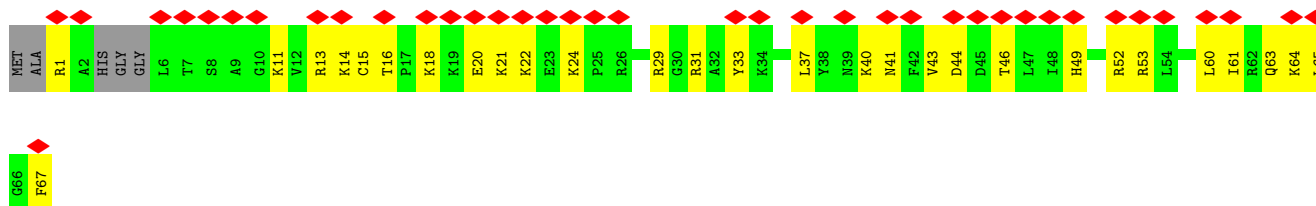

• Molecule 76: Small Subunit rRNA



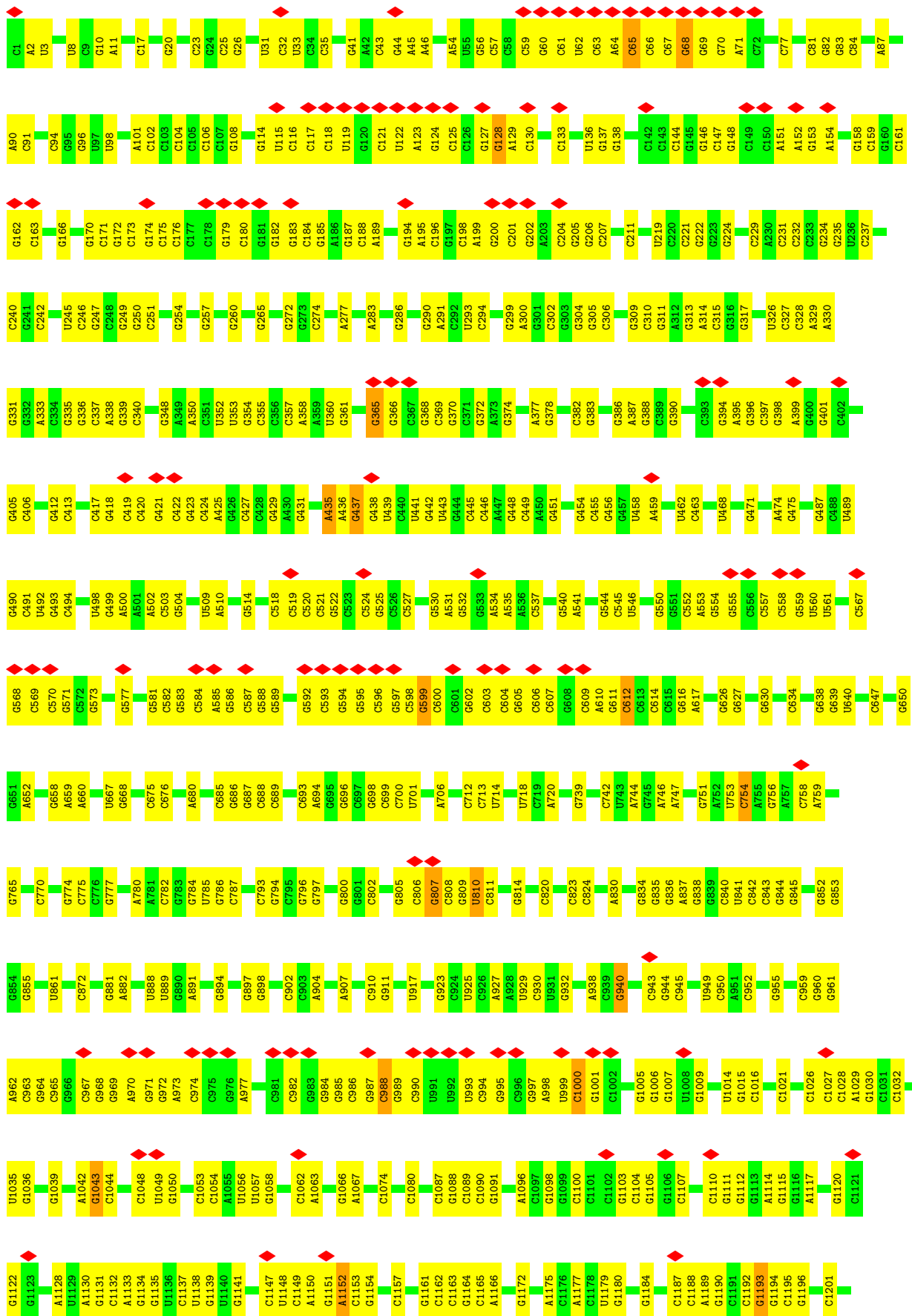

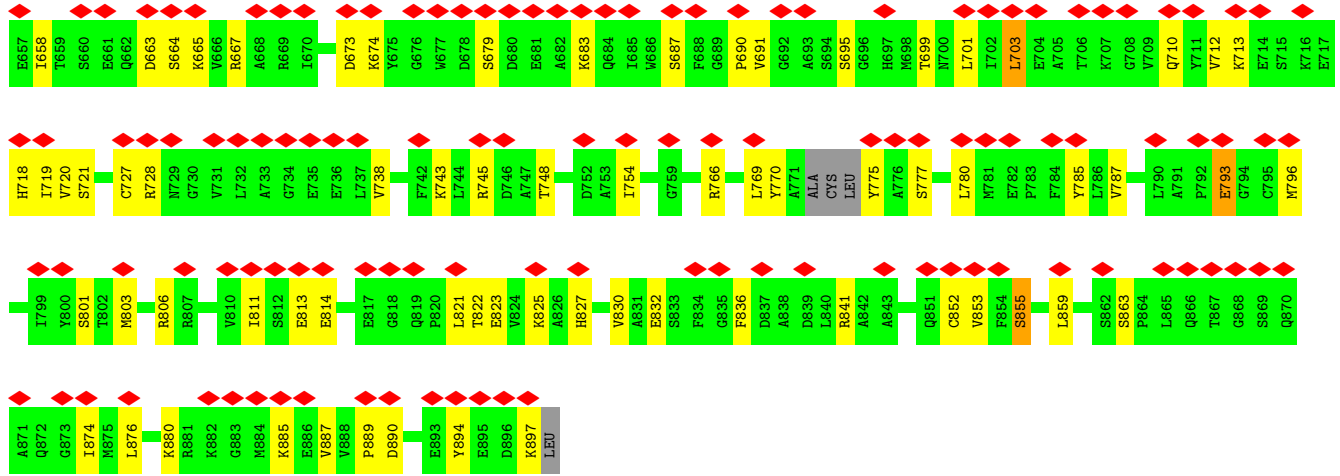

• Molecule 78: mRNA

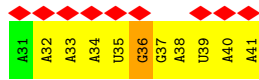
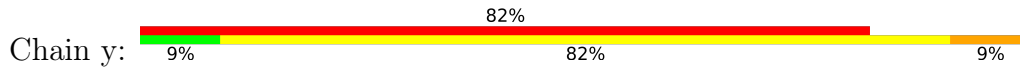

4 Experimental information

Property	Value	Source
EM reconstruction method	SINGLE PARTICLE	Depositor
Imposed symmetry	POINT, Not provided	
Number of particles used	35694	Depositor
Resolution determination method	FSC 0.143 CUT-OFF	Depositor
CTF correction method	PHASE FLIPPING AND AMPLITUDE CORRECTION	Depositor
Microscope	FEI TITAN KRIOS	Depositor
Voltage (kV)	300	Depositor
Electron dose ($e^-/\text{\AA}^2$)	30	Depositor
Minimum defocus (nm)	700	Depositor
Maximum defocus (nm)	1900	Depositor
Magnification	Not provided	
Image detector	GATAN K2 BASE (4k x 4k)	Depositor
Maximum map value	19.322	Depositor
Minimum map value	-9.629	Depositor
Average map value	0.000	Depositor
Map value standard deviation	1.000	Depositor
Recommended contour level	3.74	Depositor
Map size (Å)	410.0, 410.0, 410.0	wwPDB
Map dimensions	500, 500, 500	wwPDB
Map angles (°)	90.0, 90.0, 90.0	wwPDB
Pixel spacing (Å)	0.82, 0.82, 0.82	Depositor

5 Model quality

5.1 Standard geometry

Bond lengths and bond angles in the following residue types are not validated in this section: PO4, GDP

The Z score for a bond length (or angle) is the number of standard deviations the observed value is removed from the expected value. A bond length (or angle) with $|Z| > 5$ is considered an outlier worth inspection. RMSZ is the root-mean-square of all Z scores of the bond lengths (or angles).

Mol	Chain	Bond lengths		Bond angles	
		RMSZ	# Z >5	RMSZ	# Z >5
1	LA	0.61	0/1880	0.92	0/2528
2	LB	0.57	0/3004	0.89	1/4055 (0.0%)
3	LC	0.60	0/2463	0.84	1/3342 (0.0%)
4	LD	0.59	0/3274	0.86	0/5104
5	LE	0.56	1/2747 (0.0%)	0.87	2/4281 (0.0%)
6	LF	0.57	0/2328	0.87	0/3122
7	LG	0.52	0/442	0.84	0/590
8	LH	0.58	0/1724	0.84	0/2324
9	LI	0.58	0/1471	0.87	1/1987 (0.1%)
10	LJ	0.60	0/1453	0.84	0/1962
11	LK	0.59	0/1588	0.84	0/2128
12	LL	0.58	0/1345	0.84	0/1805
13	LM	0.58	0/1560	0.85	0/2089
14	LN	0.56	0/1018	0.81	0/1364
15	LO	0.58	0/1751	0.85	1/2346 (0.0%)
16	LP	0.59	0/1543	0.83	1/2069 (0.0%)
17	LQ	0.61	0/1244	0.88	0/1662
18	LR	0.62	0/1409	0.89	1/1884 (0.1%)
19	LS	0.57	0/1522	0.82	0/2012
20	LT	0.57	0/1451	0.84	1/1947 (0.1%)
21	LU	0.56	0/1261	0.90	2/1695 (0.1%)
22	LV	0.56	0/903	0.83	1/1216 (0.1%)
23	LW	0.56	0/1043	0.83	0/1406
24	LX	0.56	0/553	0.88	1/736 (0.1%)
25	LY	0.56	0/933	0.90	1/1262 (0.1%)
26	LZ	0.59	0/1091	0.83	0/1454
27	La	0.58	0/993	0.89	0/1339
28	Lb	0.59	0/1231	0.89	1/1647 (0.1%)
29	Lc	0.57	0/432	0.98	1/572 (0.2%)
30	Ld	0.60	0/762	0.83	0/1030
31	Le	0.57	0/809	0.89	1/1087 (0.1%)
32	Lf	0.58	0/1055	0.85	0/1407

Mol	Chain	Bond lengths		Bond angles	
		RMSZ	# Z >5	RMSZ	# Z >5
33	Lg	0.57	0/785	0.94	0/1051
34	Lh	0.60	0/861	0.87	0/1158
35	Li	0.54	0/940	0.82	0/1249
36	Lj	0.56	0/686	0.82	0/909
37	Lk	0.64	0/713	0.91	1/945 (0.1%)
38	Ll	0.57	0/537	0.90	1/716 (0.1%)
39	Ln	0.62	0/1621	0.88	0/2183
40	Lo	0.53	0/229	0.81	0/291
41	Lp	0.56	0/770	0.86	0/1018
42	Lq	0.56	0/675	0.85	0/901
43	Ls	0.59	0/378	1.02	0/504
44	Lt	0.60	2/62214 (0.0%)	0.89	50/97098 (0.1%)
45	Lu	0.62	0/1795	0.84	0/2798
46	SA	0.60	0/1587	0.87	1/2153 (0.0%)
47	SB	0.61	0/1635	0.87	1/2202 (0.0%)
48	SC	0.59	0/1640	0.82	0/2203
49	SD	0.55	0/1836	0.84	0/2473
50	SE	0.59	0/2126	0.85	0/2866
51	SF	0.61	0/1404	0.87	0/1888
52	SG	0.59	0/1808	0.85	0/2416
53	SH	0.60	0/1508	0.82	0/2032
54	SI	0.60	0/1300	0.85	0/1744
55	SJ	0.61	0/1048	0.84	0/1412
56	SK	0.59	0/1435	0.82	0/1919
57	SL	0.57	0/850	0.79	0/1157
58	SM	0.59	0/1248	0.79	0/1669
59	SO	0.57	0/1071	0.77	0/1436
60	SP	0.57	0/1210	0.79	0/1625
61	SQ	0.60	0/923	0.87	0/1239
62	SR	0.59	0/928	0.83	0/1238
63	ST	0.61	0/1192	0.90	0/1594
64	SU	0.61	0/530	0.86	0/706
65	SV	0.60	0/1129	0.95	0/1514
66	SW	0.61	0/1104	0.83	1/1484 (0.1%)
67	SX	0.59	0/826	0.84	0/1115
68	SY	0.60	0/623	0.80	0/836
69	Sb	0.57	0/956	0.89	0/1279
70	Sc	0.59	0/565	0.82	0/750
71	Sd	0.58	0/809	0.88	0/1088
72	Se	0.62	0/643	0.88	0/871
73	Sg	0.60	0/477	0.89	1/638 (0.2%)
74	Sh	0.56	0/417	1.00	2/553 (0.4%)
75	Sj	0.57	0/533	0.87	0/708

Mol	Chain	Bond lengths		Bond angles	
		RMSZ	# Z >5	RMSZ	# Z >5
76	St	0.61	0/34858	0.89	26/54401 (0.0%)
77	a	0.61	0/6460	0.87	5/8715 (0.1%)
78	y	0.59	0/270	1.12	1/419 (0.2%)
All	All	0.60	3/193436 (0.0%)	0.88	107/282616 (0.0%)

All (3) bond length outliers are listed below:

Mol	Chain	Res	Type	Atoms	Z	Observed(Å)	Ideal(Å)
5	LE	38	U	O3'-P	5.55	1.67	1.61
44	Lt	2089	U	O3'-P	5.03	1.67	1.61
44	Lt	1793	G	O3'-P	5.01	1.67	1.61

The worst 5 of 107 bond angle outliers are listed below:

Mol	Chain	Res	Type	Atoms	Z	Observed(°)	Ideal(°)
44	Lt	1252	G	C2'-C3'-O3'	9.30	129.97	109.50
44	Lt	356	G	O4'-C1'-N9	9.05	115.44	108.20
44	Lt	691	G	C2'-C3'-O3'	9.05	129.40	109.50
44	Lt	2006	G	C2'-C3'-O3'	8.28	127.72	109.50
44	Lt	1349	G	C2'-C3'-O3'	8.21	127.57	109.50

There are no chirality outliers.

There are no planarity outliers.

5.2 Too-close contacts [i](#)

Due to software issues we are unable to calculate clashes - this section is therefore empty.

5.3 Torsion angles [i](#)

5.3.1 Protein backbone [i](#)

In the following table, the Percentiles column shows the percent Ramachandran outliers of the chain as a percentile score with respect to all PDB entries followed by that with respect to all EM entries.

The Analysed column shows the number of residues for which the backbone conformation was analysed, and the total number of residues.

Mol	Chain	Analysed	Favoured	Allowed	Outliers	Percentiles	
1	LA	243/251 (97%)	232 (96%)	9 (4%)	2 (1%)	19	51
2	LB	368/379 (97%)	347 (94%)	18 (5%)	3 (1%)	19	51
3	LC	307/316 (97%)	294 (96%)	12 (4%)	1 (0%)	41	72
6	LF	281/297 (95%)	262 (93%)	18 (6%)	1 (0%)	34	67
7	LG	47/51 (92%)	46 (98%)	1 (2%)	0	100	100
8	LH	207/235 (88%)	204 (99%)	1 (0%)	2 (1%)	15	46
9	LI	176/225 (78%)	162 (92%)	12 (7%)	2 (1%)	14	44
10	LJ	179/185 (97%)	164 (92%)	13 (7%)	2 (1%)	14	44
11	LK	185/210 (88%)	178 (96%)	5 (3%)	2 (1%)	14	44
12	LL	160/173 (92%)	156 (98%)	4 (2%)	0	100	100
13	LM	188/234 (80%)	178 (95%)	7 (4%)	3 (2%)	9	34
14	LN	126/131 (96%)	118 (94%)	7 (6%)	1 (1%)	19	51
15	LO	201/204 (98%)	193 (96%)	6 (3%)	2 (1%)	15	46
16	LP	184/197 (93%)	176 (96%)	5 (3%)	3 (2%)	9	34
17	LQ	147/164 (90%)	139 (95%)	8 (5%)	0	100	100
18	LR	175/179 (98%)	166 (95%)	8 (5%)	1 (1%)	25	57
19	LS	179/196 (91%)	174 (97%)	5 (3%)	0	100	100
20	LT	165/173 (95%)	158 (96%)	6 (4%)	1 (1%)	25	57
21	LU	151/159 (95%)	138 (91%)	12 (8%)	1 (1%)	22	55
22	LV	106/124 (86%)	93 (88%)	11 (10%)	2 (2%)	8	31
23	LW	132/142 (93%)	130 (98%)	2 (2%)	0	100	100
24	LX	61/189 (32%)	58 (95%)	2 (3%)	1 (2%)	9	34
25	LY	111/141 (79%)	105 (95%)	4 (4%)	2 (2%)	8	32
26	LZ	131/135 (97%)	128 (98%)	3 (2%)	0	100	100
27	La	118/135 (87%)	104 (88%)	12 (10%)	2 (2%)	9	34
28	Lb	146/149 (98%)	139 (95%)	6 (4%)	1 (1%)	22	55
29	Lc	49/62 (79%)	44 (90%)	5 (10%)	0	100	100
30	Ld	98/109 (90%)	94 (96%)	1 (1%)	3 (3%)	4	23
31	Le	95/106 (90%)	90 (95%)	5 (5%)	0	100	100
32	Lf	123/136 (90%)	115 (94%)	6 (5%)	2 (2%)	9	34
33	Lg	95/123 (77%)	91 (96%)	4 (4%)	0	100	100
34	Lh	104/120 (87%)	94 (90%)	9 (9%)	1 (1%)	15	46

Continued on next page...

Continued from previous page...

Mol	Chain	Analysed	Favoured	Allowed	Outliers	Percentiles	
35	Li	111/124 (90%)	107 (96%)	4 (4%)	0	100	100
36	Lj	79/90 (88%)	76 (96%)	2 (2%)	1 (1%)	12	39
37	Lk	84/89 (94%)	79 (94%)	5 (6%)	0	100	100
38	Ll	65/77 (84%)	61 (94%)	3 (5%)	1 (2%)	10	36
39	Ln	194/217 (89%)	177 (91%)	16 (8%)	1 (0%)	29	61
40	Lo	23/25 (92%)	23 (100%)	0	0	100	100
41	Lp	90/106 (85%)	87 (97%)	3 (3%)	0	100	100
42	Lq	84/94 (89%)	81 (96%)	2 (2%)	1 (1%)	13	41
43	Ls	43/127 (34%)	37 (86%)	3 (7%)	3 (7%)	1	7
46	SA	191/245 (78%)	178 (93%)	12 (6%)	1 (0%)	29	61
47	SB	202/242 (84%)	191 (95%)	7 (4%)	4 (2%)	7	30
48	SC	202/217 (93%)	190 (94%)	11 (5%)	1 (0%)	29	61
49	SD	219/248 (88%)	210 (96%)	9 (4%)	0	100	100
50	SE	255/268 (95%)	234 (92%)	19 (8%)	2 (1%)	19	51
51	SF	173/190 (91%)	167 (96%)	5 (3%)	1 (1%)	25	57
52	SG	222/248 (90%)	207 (93%)	13 (6%)	2 (1%)	17	49
53	SH	182/190 (96%)	166 (91%)	15 (8%)	1 (0%)	29	61
54	SI	159/174 (91%)	152 (96%)	6 (4%)	1 (1%)	25	57
55	SJ	127/130 (98%)	117 (92%)	9 (7%)	1 (1%)	19	51
56	SK	173/189 (92%)	164 (95%)	6 (4%)	3 (2%)	9	34
57	SL	99/134 (74%)	97 (98%)	2 (2%)	0	100	100
58	SM	143/154 (93%)	134 (94%)	7 (5%)	2 (1%)	11	37
59	SO	134/143 (94%)	131 (98%)	3 (2%)	0	100	100
60	SP	147/154 (96%)	142 (97%)	4 (3%)	1 (1%)	22	55
61	SQ	122/145 (84%)	112 (92%)	8 (7%)	2 (2%)	9	34
62	SR	108/145 (74%)	102 (94%)	5 (5%)	1 (1%)	17	49
63	ST	149/158 (94%)	135 (91%)	13 (9%)	1 (1%)	22	55
64	SU	64/137 (47%)	59 (92%)	4 (6%)	1 (2%)	9	34
65	SV	138/154 (90%)	112 (81%)	21 (15%)	5 (4%)	3	21
66	SW	136/139 (98%)	126 (93%)	8 (6%)	2 (2%)	10	36
67	SX	100/126 (79%)	100 (100%)	0	0	100	100

Continued on next page...

Continued from previous page...

Mol	Chain	Analysed	Favoured	Allowed	Outliers	Percentiles	
68	SY	80/89 (90%)	74 (92%)	4 (5%)	2 (2%)	5	26
69	Sb	116/132 (88%)	104 (90%)	9 (8%)	3 (3%)	5	26
70	Sc	67/88 (76%)	63 (94%)	3 (4%)	1 (2%)	10	36
71	Sd	96/109 (88%)	91 (95%)	5 (5%)	0	100	100
72	Se	78/81 (96%)	70 (90%)	7 (9%)	1 (1%)	12	39
73	Sg	58/64 (91%)	53 (91%)	5 (9%)	0	100	100
74	Sh	47/51 (92%)	45 (96%)	2 (4%)	0	100	100
75	Sj	60/69 (87%)	55 (92%)	5 (8%)	0	100	100
77	a	805/898 (90%)	748 (93%)	45 (6%)	12 (2%)	10	36
All	All	10663/12090 (88%)	10027 (94%)	537 (5%)	99 (1%)	21	49

5 of 99 Ramachandran outliers are listed below:

Mol	Chain	Res	Type
1	LA	15	VAL
1	LA	231	PRO
2	LB	303	LYS
34	Lh	6	VAL
42	Lq	6	LYS

5.3.2 Protein sidechains [i](#)

In the following table, the Percentiles column shows the percent sidechain outliers of the chain as a percentile score with respect to all PDB entries followed by that with respect to all EM entries.

The Analysed column shows the number of residues for which the sidechain conformation was analysed, and the total number of residues.

Mol	Chain	Analysed	Rotameric	Outliers	Percentiles	
1	LA	188/192 (98%)	144 (77%)	44 (23%)	1	2
2	LB	306/313 (98%)	236 (77%)	70 (23%)	1	2
3	LC	257/263 (98%)	200 (78%)	57 (22%)	1	2
6	LF	231/242 (96%)	170 (74%)	61 (26%)	0	1
7	LG	46/48 (96%)	36 (78%)	10 (22%)	1	3
8	LH	181/204 (89%)	143 (79%)	38 (21%)	1	3
9	LI	161/198 (81%)	120 (74%)	41 (26%)	0	2

Continued on next page...

Continued from previous page...

Mol	Chain	Analysed	Rotameric	Outliers	Percentiles	
10	LJ	160/164 (98%)	114 (71%)	46 (29%)	0	1
11	LK	162/177 (92%)	119 (74%)	43 (26%)	0	1
12	LL	141/149 (95%)	103 (73%)	38 (27%)	0	1
13	LM	163/197 (83%)	118 (72%)	45 (28%)	0	1
14	LN	108/111 (97%)	76 (70%)	32 (30%)	0	1
15	LO	174/175 (99%)	135 (78%)	39 (22%)	1	2
16	LP	156/165 (94%)	111 (71%)	45 (29%)	0	1
17	LQ	130/139 (94%)	94 (72%)	36 (28%)	0	1
18	LR	153/155 (99%)	109 (71%)	44 (29%)	0	1
19	LS	155/167 (93%)	113 (73%)	42 (27%)	0	1
20	LT	151/154 (98%)	116 (77%)	35 (23%)	1	2
21	LU	128/133 (96%)	91 (71%)	37 (29%)	0	1
22	LV	96/110 (87%)	59 (62%)	37 (38%)	0	0
23	LW	108/114 (95%)	76 (70%)	32 (30%)	0	1
24	LX	61/174 (35%)	42 (69%)	19 (31%)	0	1
25	LY	102/123 (83%)	76 (74%)	26 (26%)	0	2
26	LZ	114/115 (99%)	82 (72%)	32 (28%)	0	1
27	La	107/119 (90%)	72 (67%)	35 (33%)	0	1
28	Lb	126/127 (99%)	96 (76%)	30 (24%)	0	2
29	Lc	47/57 (82%)	35 (74%)	12 (26%)	0	2
30	Ld	85/92 (92%)	60 (71%)	25 (29%)	0	1
31	Le	85/92 (92%)	70 (82%)	15 (18%)	2	6
32	Lf	111/120 (92%)	83 (75%)	28 (25%)	0	2
33	Lg	81/103 (79%)	58 (72%)	23 (28%)	0	1
34	Lh	91/100 (91%)	72 (79%)	19 (21%)	1	3
35	Li	99/107 (92%)	69 (70%)	30 (30%)	0	1
36	Lj	71/78 (91%)	48 (68%)	23 (32%)	0	1
37	Lk	72/74 (97%)	47 (65%)	25 (35%)	0	1
38	Ll	61/68 (90%)	35 (57%)	26 (43%)	0	0
39	Ln	173/189 (92%)	82 (47%)	91 (53%)	0	0
40	Lo	22/22 (100%)	15 (68%)	7 (32%)	0	1

Continued on next page...

Continued from previous page...

Mol	Chain	Analysed	Rotameric	Outliers	Percentiles	
41	Lp	82/93 (88%)	62 (76%)	20 (24%)	0	2
42	Lq	67/73 (92%)	44 (66%)	23 (34%)	0	1
43	Ls	41/110 (37%)	26 (63%)	15 (37%)	0	0
46	SA	170/217 (78%)	109 (64%)	61 (36%)	0	0
47	SB	172/201 (86%)	103 (60%)	69 (40%)	0	0
48	SC	170/182 (93%)	107 (63%)	63 (37%)	0	0
49	SD	201/220 (91%)	141 (70%)	60 (30%)	0	1
50	SE	228/232 (98%)	138 (60%)	90 (40%)	0	0
51	SF	148/157 (94%)	98 (66%)	50 (34%)	0	1
52	SG	193/213 (91%)	106 (55%)	87 (45%)	0	0
53	SH	165/170 (97%)	104 (63%)	61 (37%)	0	0
54	SI	138/148 (93%)	81 (59%)	57 (41%)	0	0
55	SJ	114/115 (99%)	74 (65%)	40 (35%)	0	1
56	SK	154/164 (94%)	106 (69%)	48 (31%)	0	1
57	SL	90/119 (76%)	63 (70%)	27 (30%)	0	1
58	SM	131/136 (96%)	94 (72%)	37 (28%)	0	1
59	SO	108/114 (95%)	64 (59%)	44 (41%)	0	0
60	SP	125/130 (96%)	89 (71%)	36 (29%)	0	1
61	SQ	86/113 (76%)	60 (70%)	26 (30%)	0	1
62	SR	100/128 (78%)	71 (71%)	29 (29%)	0	1
63	ST	125/130 (96%)	75 (60%)	50 (40%)	0	0
64	SU	58/124 (47%)	36 (62%)	22 (38%)	0	0
65	SV	118/131 (90%)	68 (58%)	50 (42%)	0	0
66	SW	114/115 (99%)	66 (58%)	48 (42%)	0	0
67	SX	91/110 (83%)	66 (72%)	25 (28%)	0	1
68	SY	65/72 (90%)	36 (55%)	29 (45%)	0	0
69	Sb	103/113 (91%)	55 (53%)	48 (47%)	0	0
70	Sc	63/79 (80%)	39 (62%)	24 (38%)	0	0
71	Sd	92/103 (89%)	67 (73%)	25 (27%)	0	1
72	Se	72/73 (99%)	39 (54%)	33 (46%)	0	0
73	Sg	53/57 (93%)	25 (47%)	28 (53%)	0	0

Continued on next page...

Continued from previous page...

Mol	Chain	Analysed	Rotameric	Outliers	Percentiles	
74	Sh	43/45 (96%)	23 (54%)	20 (46%)	0	0
75	Sj	56/58 (97%)	27 (48%)	29 (52%)	0	0
77	a	697/765 (91%)	451 (65%)	246 (35%)	0	1
All	All	9296/10340 (90%)	6338 (68%)	2958 (32%)	1	1

5 of 2958 residues with a non-rotameric sidechain are listed below:

Mol	Chain	Res	Type
52	SG	173	LEU
63	ST	44	LYS
53	SH	94	ILE
52	SG	167	CYS
56	SK	175	LYS

Sometimes sidechains can be flipped to improve hydrogen bonding and reduce clashes. 5 of 88 such sidechains are listed below:

Mol	Chain	Res	Type
56	SK	143	ASN
65	SV	88	ASN
58	SM	13	GLN
63	ST	95	GLN
69	Sb	45	GLN

5.3.3 RNA [i](#)

Mol	Chain	Analysed	Backbone Outliers	Pucker Outliers
4	LD	135/142 (95%)	49 (36%)	3 (2%)
44	Lt	2588/2697 (95%)	1013 (39%)	0
45	Lu	74/75 (98%)	42 (56%)	0
5	LE	114/121 (94%)	36 (31%)	5 (4%)
76	St	1453/1454 (99%)	678 (46%)	0
78	y	10/11 (90%)	10 (100%)	0
All	All	4374/4500 (97%)	1828 (41%)	8 (0%)

5 of 1828 RNA backbone outliers are listed below:

Mol	Chain	Res	Type
4	LD	9	C
4	LD	17	G

Continued on next page...

Continued from previous page...

Mol	Chain	Res	Type
4	LD	19	U
4	LD	20	G
4	LD	21	C

5 of 8 RNA pucker outliers are listed below:

Mol	Chain	Res	Type
5	LE	110	U
5	LE	96	G
5	LE	63	U
5	LE	38	U
5	LE	85	U

5.4 Non-standard residues in protein, DNA, RNA chains [i](#)

There are no non-standard protein/DNA/RNA residues in this entry.

5.5 Carbohydrates [i](#)

There are no monosaccharides in this entry.

5.6 Ligand geometry [i](#)

2 ligands are modelled in this entry.

In the following table, the Counts columns list the number of bonds (or angles) for which Mogul statistics could be retrieved, the number of bonds (or angles) that are observed in the model and the number of bonds (or angles) that are defined in the Chemical Component Dictionary. The Link column lists molecule types, if any, to which the group is linked. The Z score for a bond length (or angle) is the number of standard deviations the observed value is removed from the expected value. A bond length (or angle) with $|Z| > 2$ is considered an outlier worth inspection. RMSZ is the root-mean-square of all Z scores of the bond lengths (or angles).

Mol	Type	Chain	Res	Link	Bond lengths			Bond angles		
					Counts	RMSZ	# Z > 2	Counts	RMSZ	# Z > 2
80	GDP	a	902	-	24,30,30	1.01	1 (4%)	30,47,47	1.36	4 (13%)
79	PO4	a	901	-	4,4,4	0.72	0	6,6,6	0.45	0

In the following table, the Chirals column lists the number of chiral outliers, the number of chiral centers analysed, the number of these observed in the model and the number defined in the Chemical Component Dictionary. Similar counts are reported in the Torsion and Rings columns.

'-' means no outliers of that kind were identified.

Mol	Type	Chain	Res	Link	Chirals	Torsions	Rings
80	GDP	a	902	-	-	5/12/32/32	0/3/3/3

All (1) bond length outliers are listed below:

Mol	Chain	Res	Type	Atoms	Z	Observed(Å)	Ideal(Å)
80	a	902	GDP	C6-N1	-3.14	1.33	1.37

All (4) bond angle outliers are listed below:

Mol	Chain	Res	Type	Atoms	Z	Observed(°)	Ideal(°)
80	a	902	GDP	PA-O3A-PB	-3.07	122.30	132.83
80	a	902	GDP	C3'-C2'-C1'	2.78	105.16	100.98
80	a	902	GDP	C5-C6-N1	2.73	118.77	113.95
80	a	902	GDP	O6-C6-C5	-2.07	120.32	124.37

There are no chirality outliers.

All (5) torsion outliers are listed below:

Mol	Chain	Res	Type	Atoms
80	a	902	GDP	C5'-O5'-PA-O3A
80	a	902	GDP	C5'-O5'-PA-O1A
80	a	902	GDP	O4'-C4'-C5'-O5'
80	a	902	GDP	C3'-C4'-C5'-O5'
80	a	902	GDP	C5'-O5'-PA-O2A

There are no ring outliers.

No monomer is involved in short contacts.

The following is a two-dimensional graphical depiction of Mogul quality analysis of bond lengths, bond angles, torsion angles, and ring geometry for all instances of the Ligand of Interest. In addition, ligands with molecular weight > 250 and outliers as shown on the validation Tables will also be included. For torsion angles, if less than 5% of the Mogul distribution of torsion angles is within 10 degrees of the torsion angle in question, then that torsion angle is considered an outlier. Any bond that is central to one or more torsion angles identified as an outlier by Mogul will be highlighted in the graph. For rings, the root-mean-square deviation (RMSD) between the ring in question and similar rings identified by Mogul is calculated over all ring torsion angles. If the average RMSD is greater than 60 degrees and the minimal RMSD between the ring in question and any Mogul-identified rings is also greater than 60 degrees, then that ring is considered an outlier. The outliers are highlighted in purple. The color gray indicates Mogul did not find sufficient equivalents in the CSD to analyse the geometry.

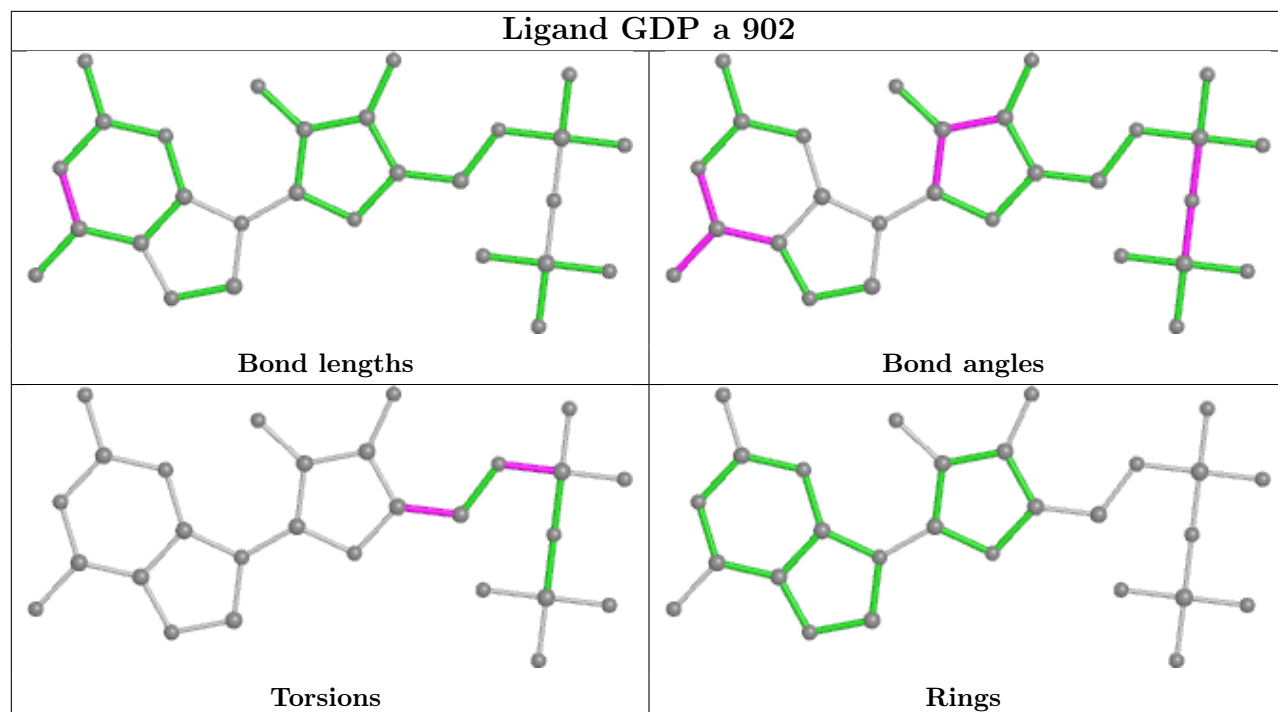

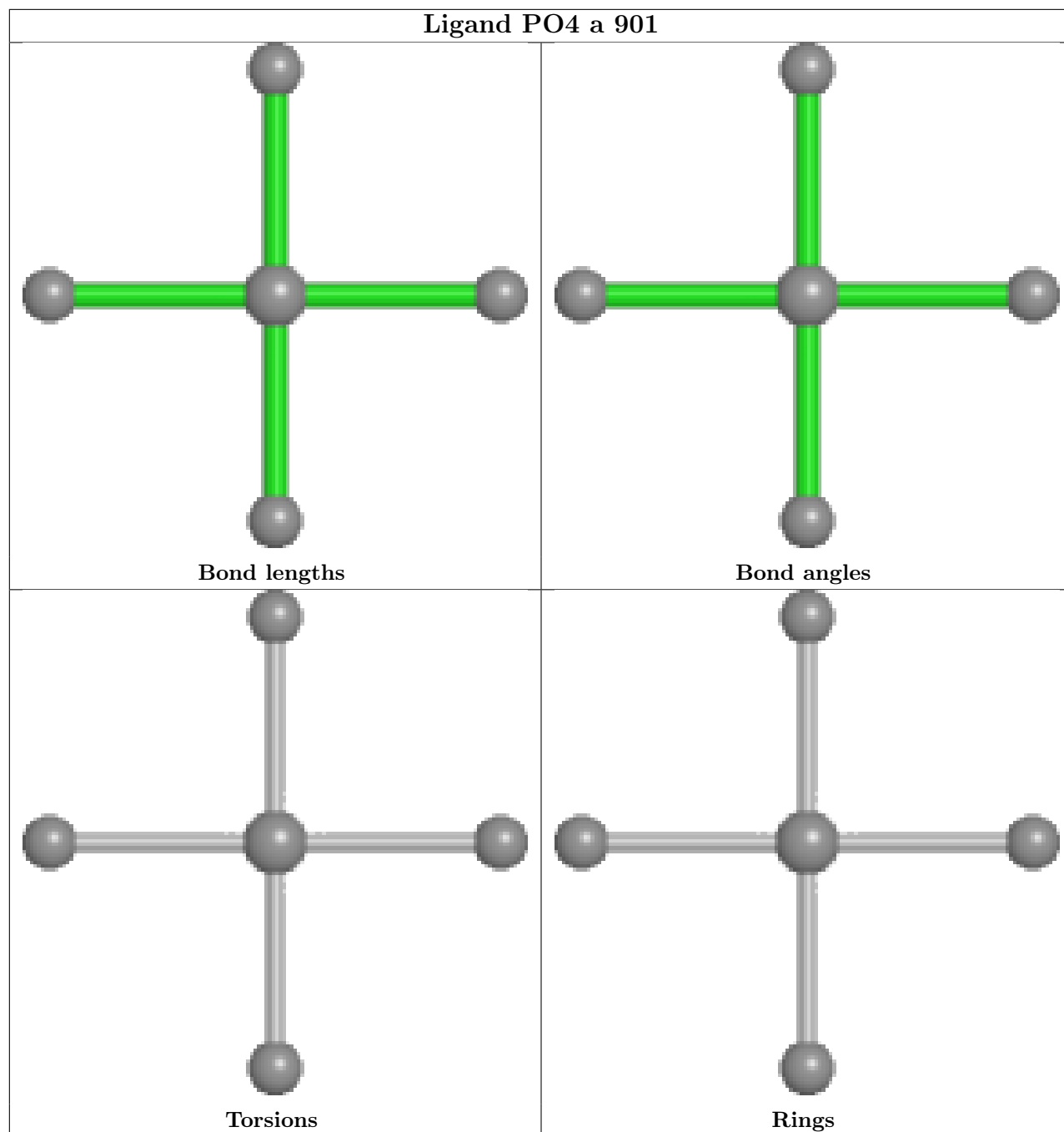

5.7 Other polymers [i](#)

There are no such residues in this entry.

5.8 Polymer linkage issues [i](#)

There are no chain breaks in this entry.

6 Map visualisation [i](#)

This section contains visualisations of the EMDB entry EMD-16225. These allow visual inspection of the internal detail of the map and identification of artifacts.

Images derived from a raw map, generated by summing the deposited half-maps, are presented below the corresponding image components of the primary map to allow further visual inspection and comparison with those of the primary map.

6.1 Orthogonal projections [i](#)

6.1.1 Primary map

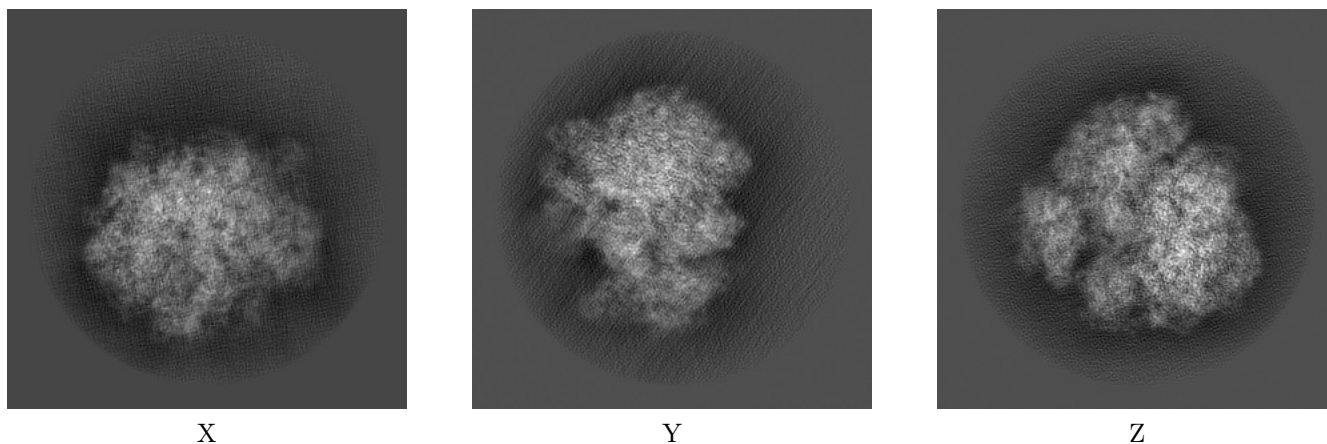

6.1.2 Raw map

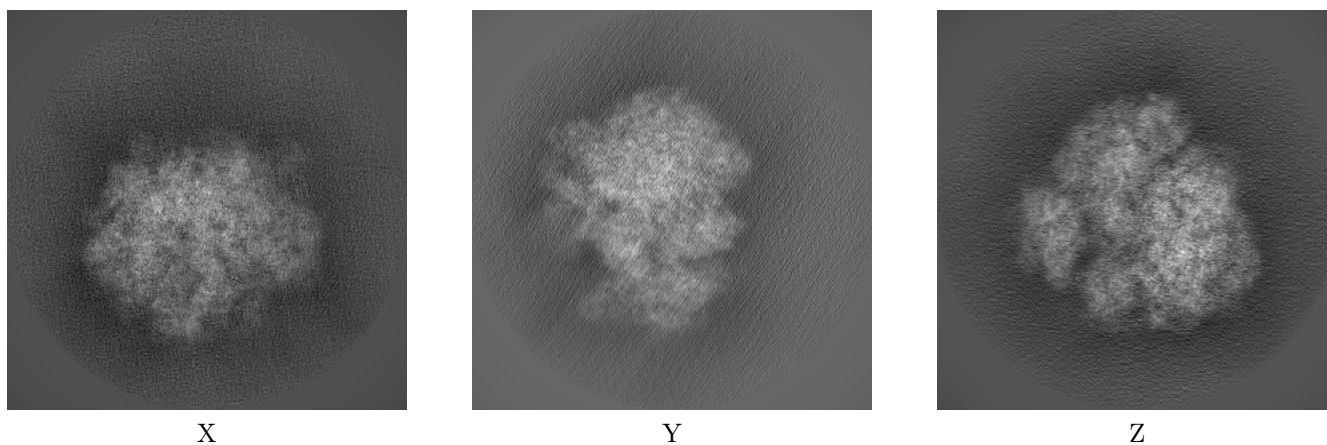

The images above show the map projected in three orthogonal directions.

6.2 Central slices [i](#)

6.2.1 Primary map

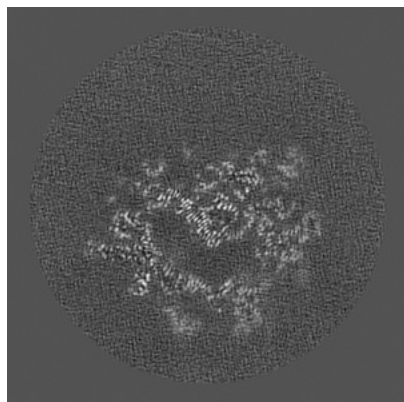

X Index: 250

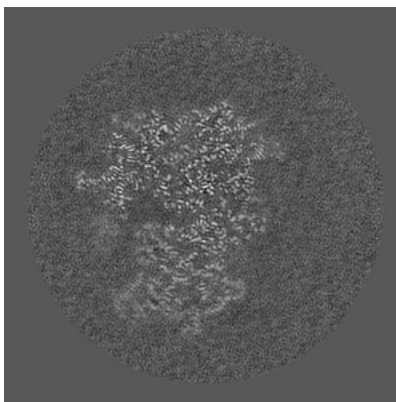

Y Index: 250

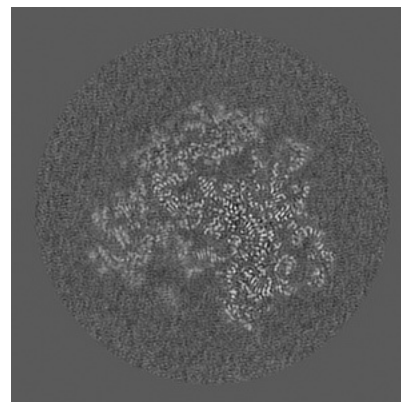

Z Index: 250

6.2.2 Raw map

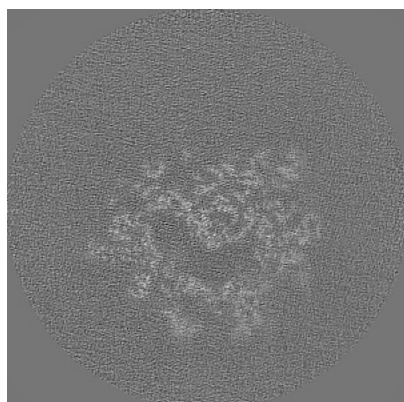

X Index: 250

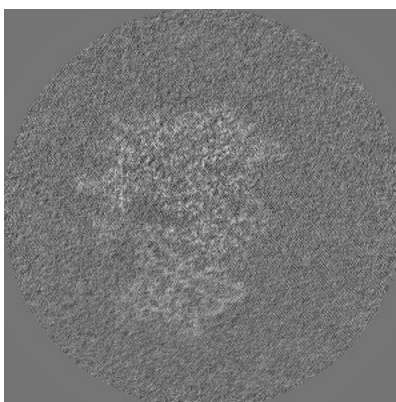

Y Index: 250

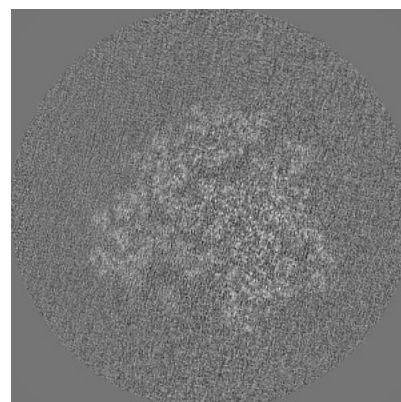

Z Index: 250

The images above show central slices of the map in three orthogonal directions.

6.3 Largest variance slices [i](#)

6.3.1 Primary map

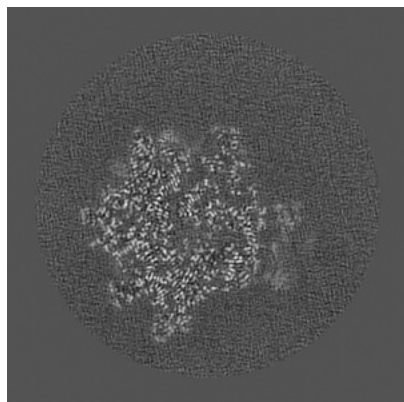

X Index: 306

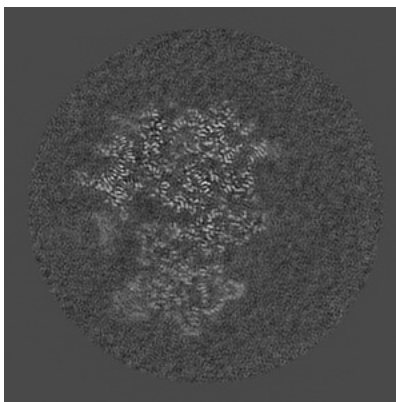

Y Index: 248

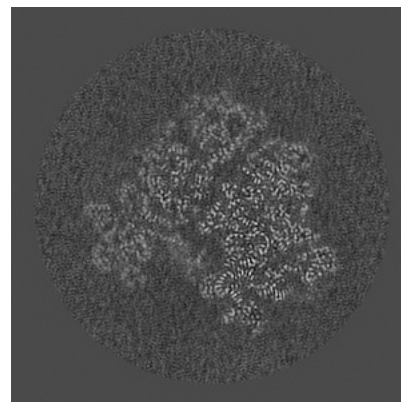

Z Index: 240

6.3.2 Raw map

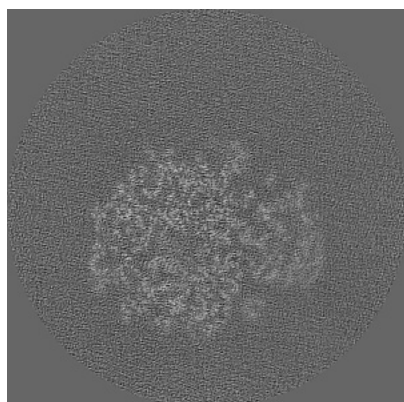

X Index: 276

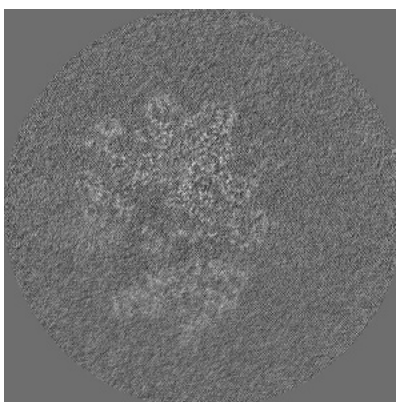

Y Index: 236

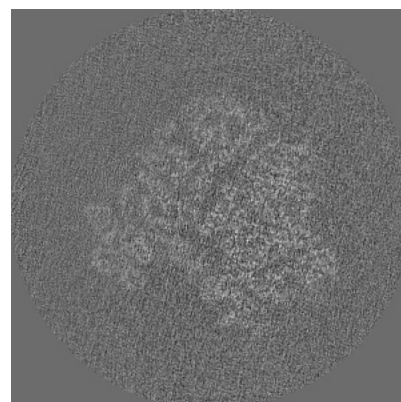

Z Index: 240

The images above show the largest variance slices of the map in three orthogonal directions.

6.4 Orthogonal standard-deviation projections (False-color) [i](#)

6.4.1 Primary map

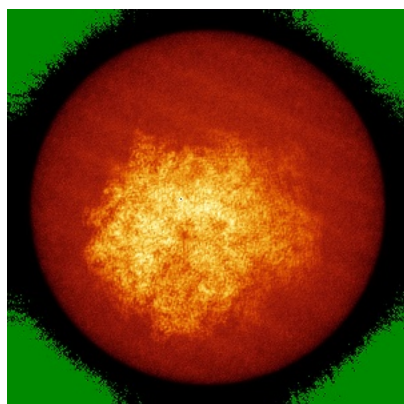

X

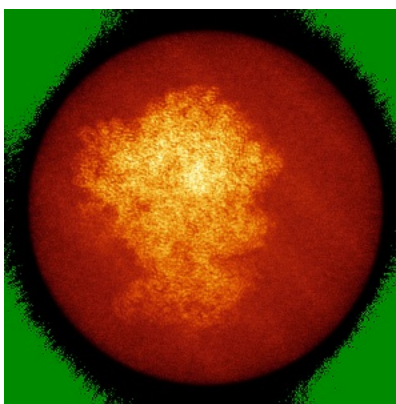

Y

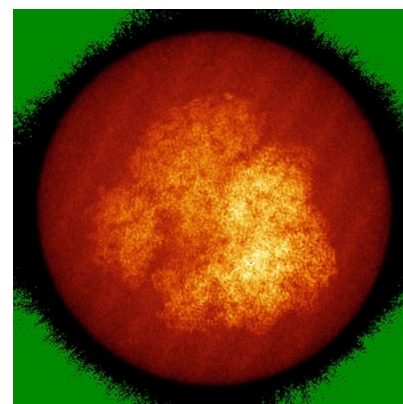

Z

6.4.2 Raw map

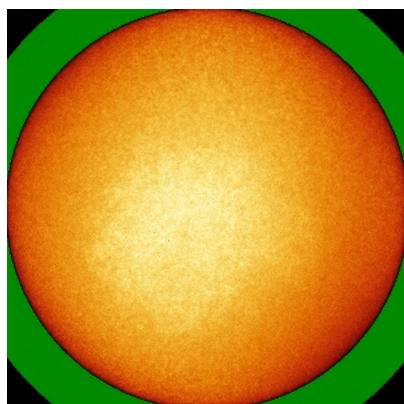

X

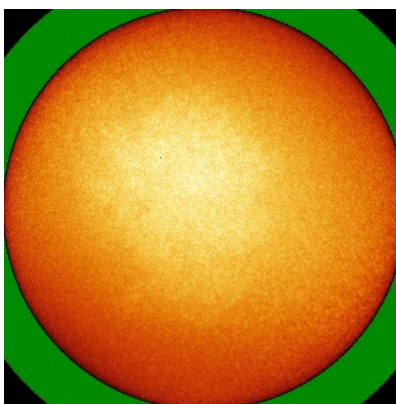

Y

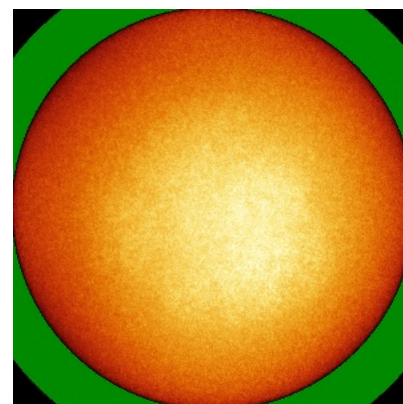

Z

The images above show the map standard deviation projections with false color in three orthogonal directions. Minimum values are shown in green, max in blue, and dark to light orange shades represent small to large values respectively.

6.5 Orthogonal surface views [i](#)

6.5.1 Primary map

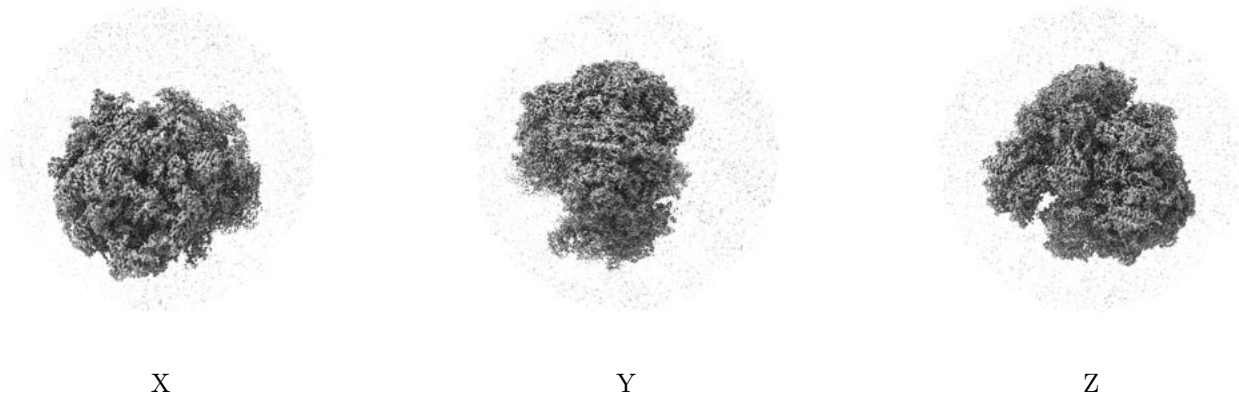

The images above show the 3D surface view of the map at the recommended contour level 3.74. These images, in conjunction with the slice images, may facilitate assessment of whether an appropriate contour level has been provided.

6.5.2 Raw map

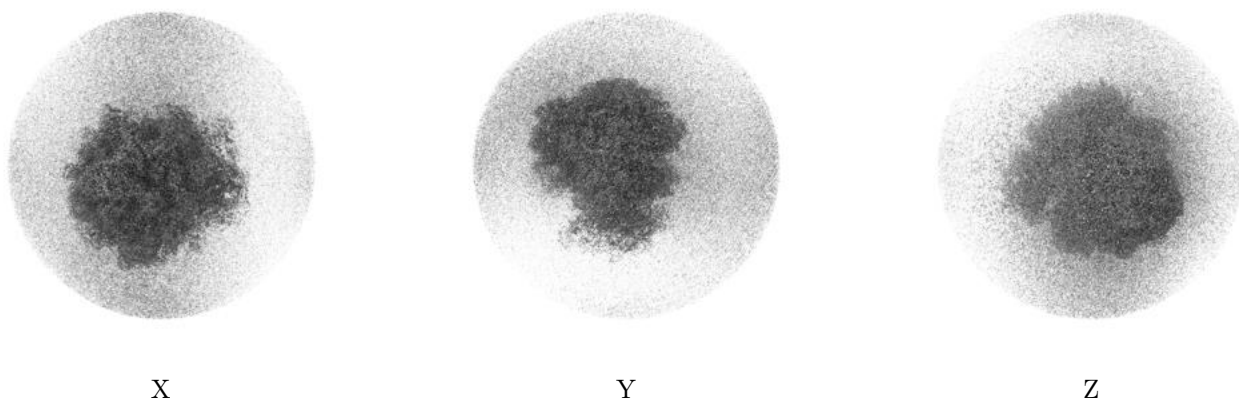

These images show the 3D surface of the raw map. The raw map's contour level was selected so that its surface encloses the same volume as the primary map does at its recommended contour level.

6.6 Mask visualisation [i](#)

This section was not generated. No masks/segmentation were deposited.

7 Map analysis [i](#)

This section contains the results of statistical analysis of the map.

7.1 Map-value distribution [i](#)

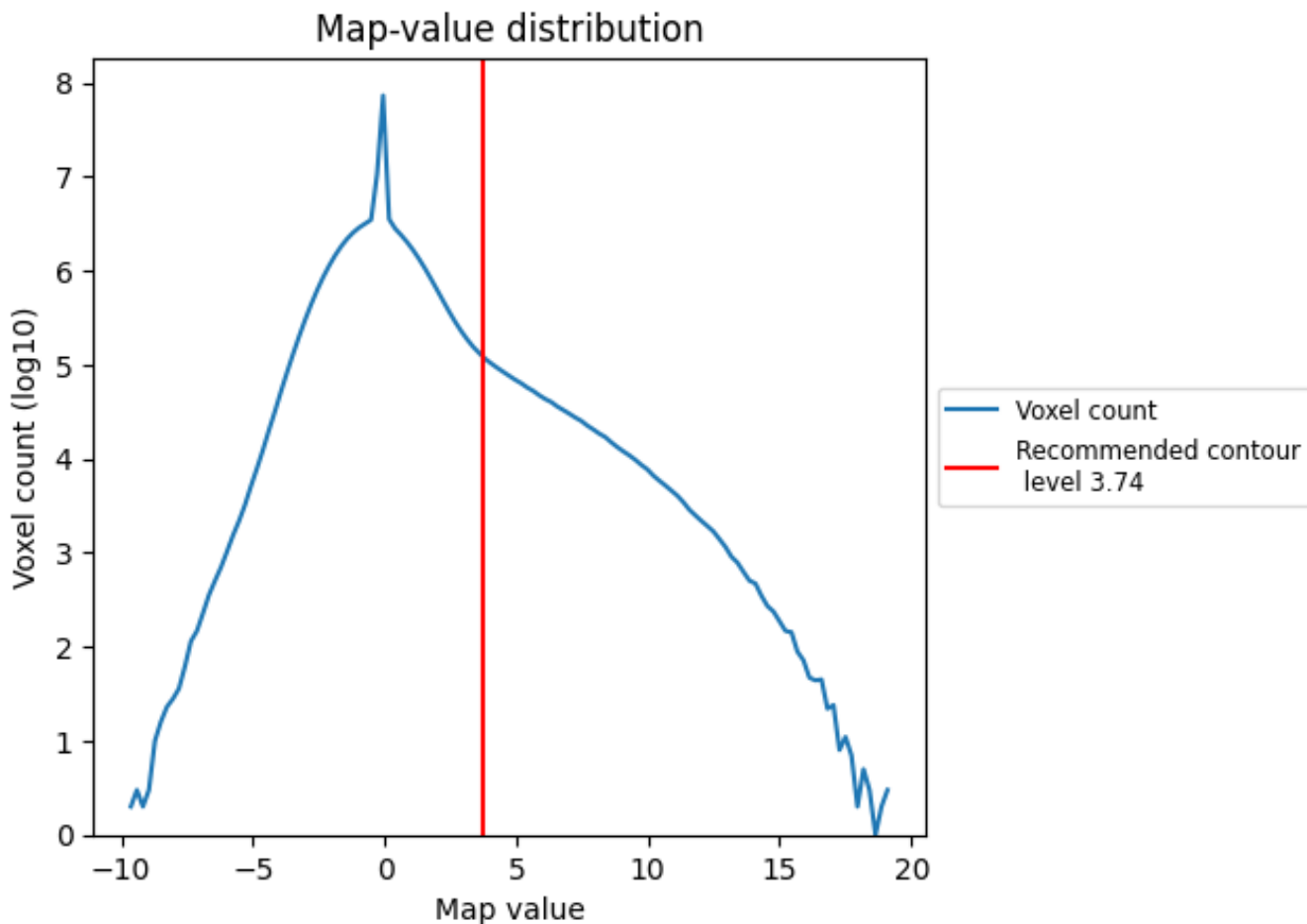

The map-value distribution is plotted in 128 intervals along the x-axis. The y-axis is logarithmic. A spike in this graph at zero usually indicates that the volume has been masked.

7.2 Volume estimate [\(i\)](#)

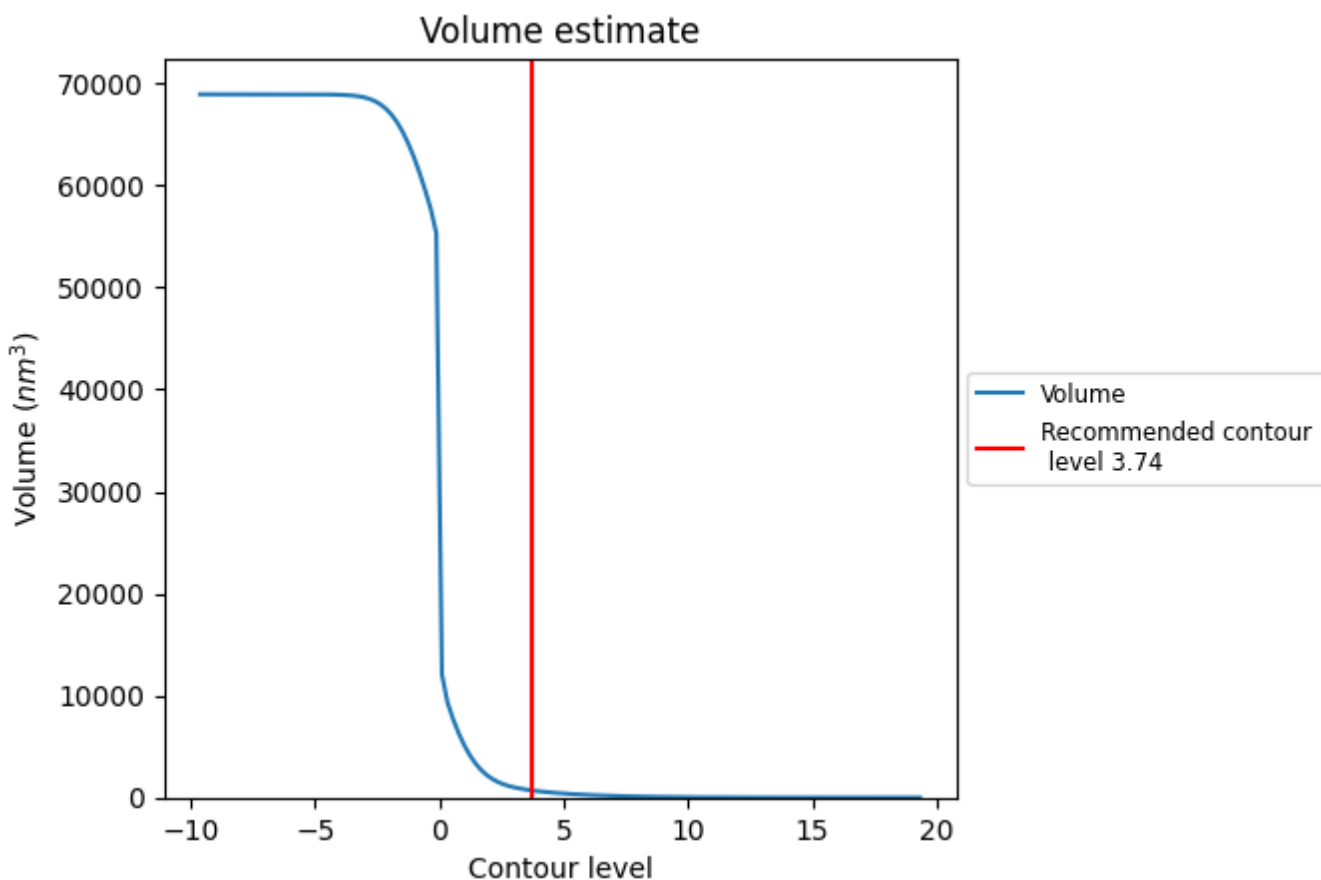

The volume at the recommended contour level is 690 nm^3 ; this corresponds to an approximate mass of 623 kDa.

The volume estimate graph shows how the enclosed volume varies with the contour level. The recommended contour level is shown as a vertical line and the intersection between the line and the curve gives the volume of the enclosed surface at the given level.

7.3 Rotationally averaged power spectrum [i](#)

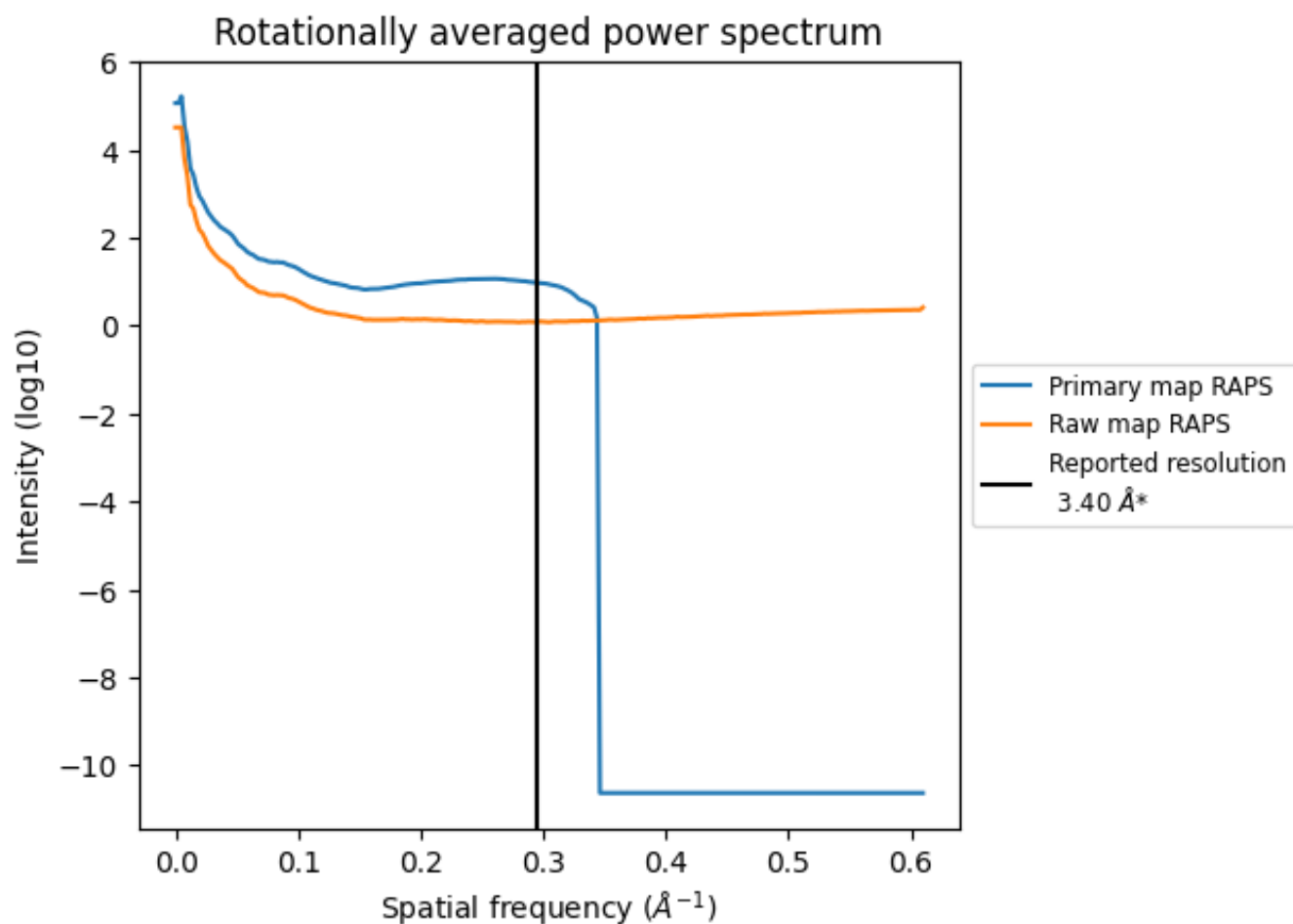

*Reported resolution corresponds to spatial frequency of 0.294 Å⁻¹

8 Fourier-Shell correlation [i](#)

Fourier-Shell Correlation (FSC) is the most commonly used method to estimate the resolution of single-particle and subtomogram-averaged maps. The shape of the curve depends on the imposed symmetry, mask and whether or not the two 3D reconstructions used were processed from a common reference. The reported resolution is shown as a black line. A curve is displayed for the half-bit criterion in addition to lines showing the 0.143 gold standard cut-off and 0.5 cut-off.

8.1 FSC [i](#)

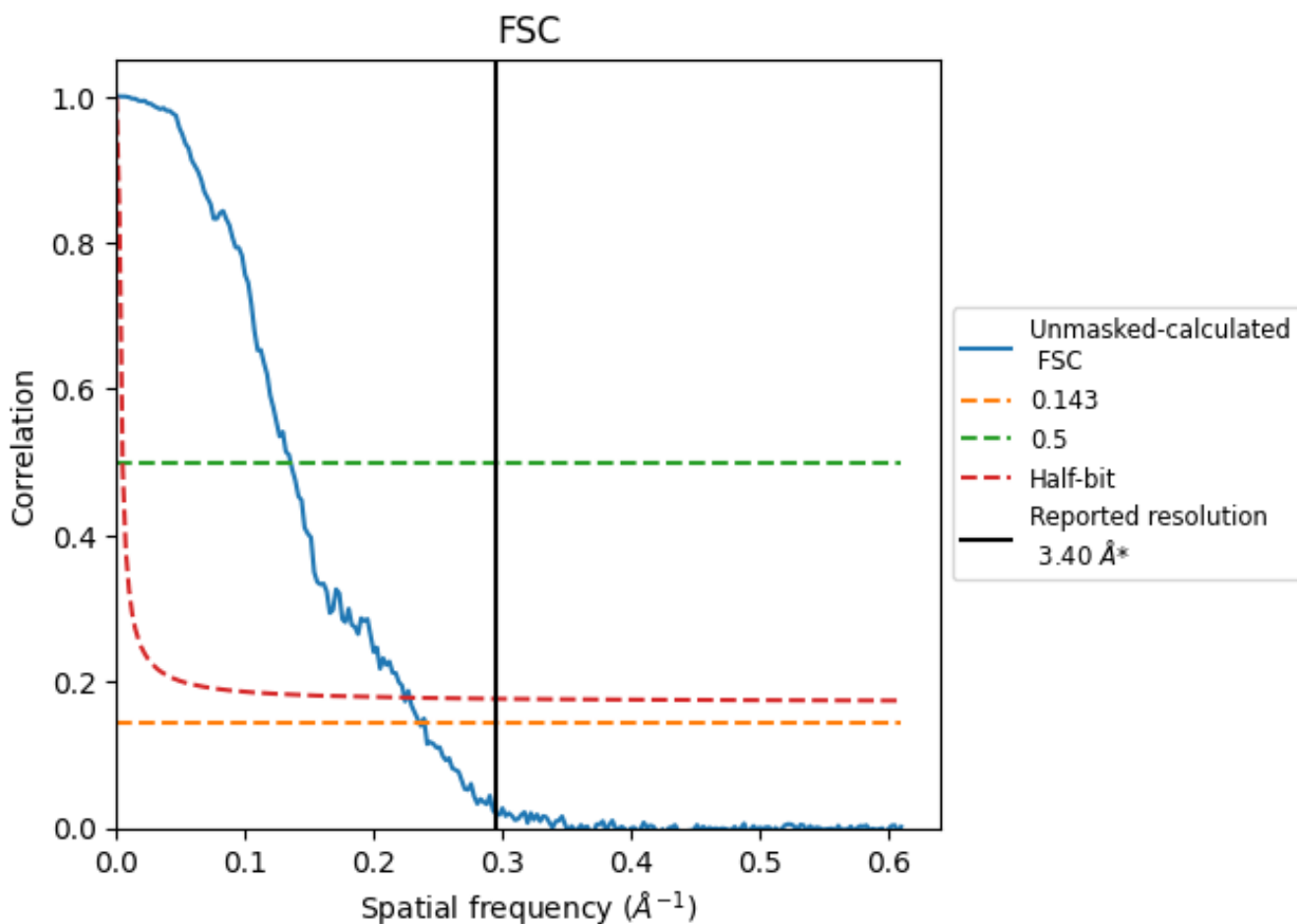

*Reported resolution corresponds to spatial frequency of 0.294 Å⁻¹

8.2 Resolution estimates [i](#)

Resolution estimate (Å)	Estimation criterion (FSC cut-off)		
	0.143	0.5	Half-bit
Reported by author	3.40	-	-
Author-provided FSC curve	-	-	-
Unmasked-calculated*	4.24	7.39	4.47

*Resolution estimate based on FSC curve calculated by comparison of deposited half-maps. The value from deposited half-maps intersecting FSC 0.143 CUT-OFF 4.24 differs from the reported value 3.4 by more than 10 %

9 Map-model fit [i](#)

This section contains information regarding the fit between EMDB map EMD-16225 and PDB model 8BSI. Per-residue inclusion information can be found in section 3 on page 19.

9.1 Map-model overlay [i](#)

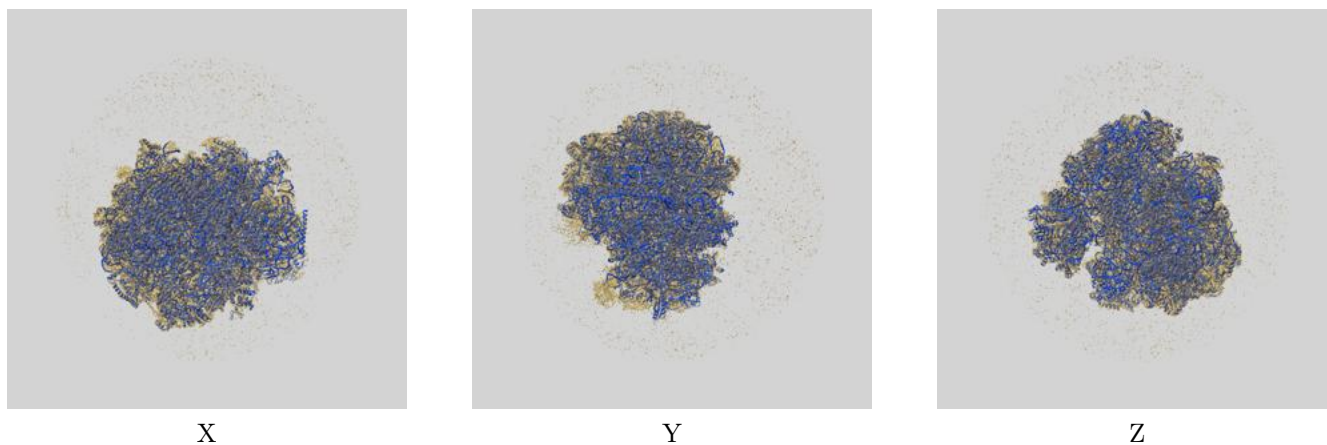

The images above show the 3D surface view of the map at the recommended contour level 3.74 at 50% transparency in yellow overlaid with a ribbon representation of the model coloured in blue. These images allow for the visual assessment of the quality of fit between the atomic model and the map.

9.2 Q-score mapped to coordinate model [i](#)

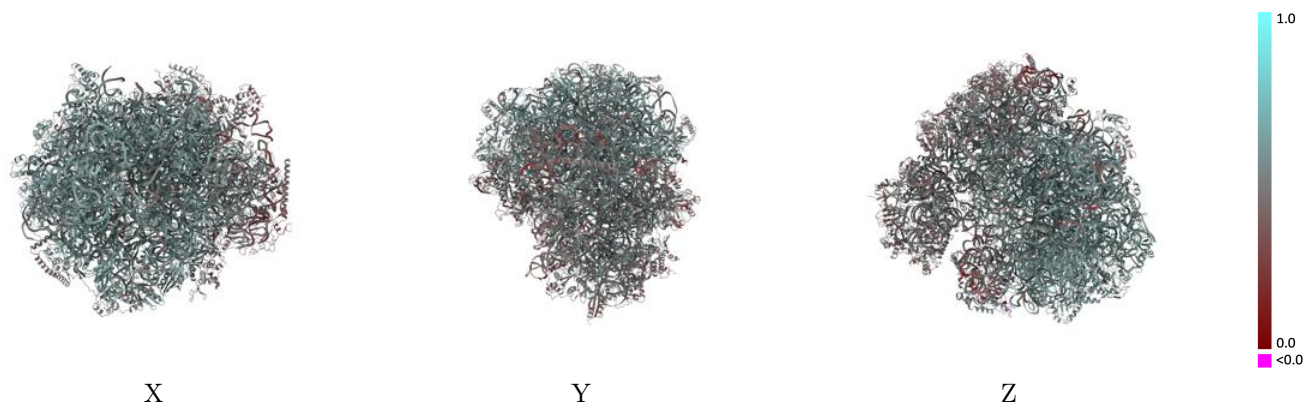

The images above show the model with each residue coloured according to its Q-score. This shows their resolvability in the map with higher Q-score values reflecting better resolvability. Please note: Q-score is calculating the resolvability of atoms, and thus high values are only expected at resolutions at which atoms can be resolved. Low Q-score values may therefore be expected for many entries.

9.3 Atom inclusion mapped to coordinate model [i](#)

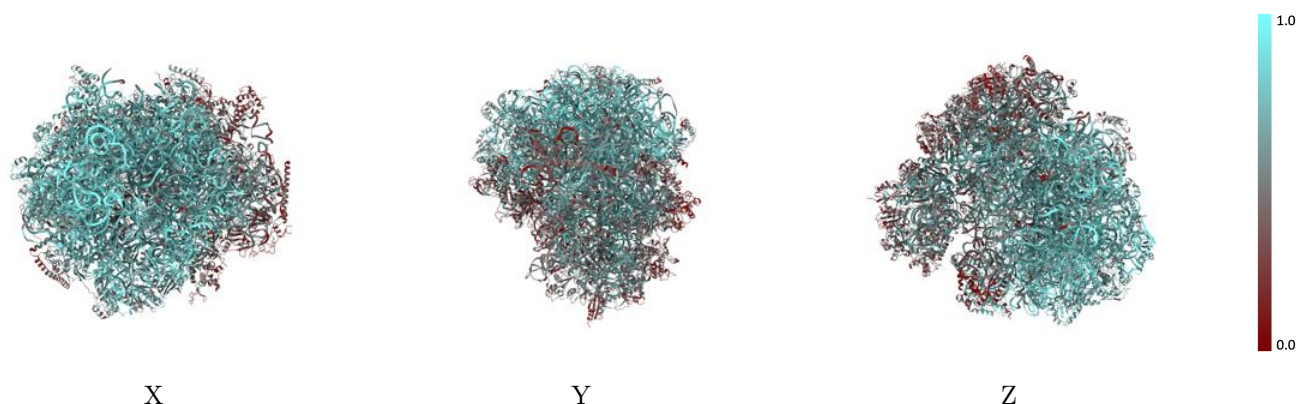

The images above show the model with each residue coloured according to its atom inclusion. This shows to what extent they are inside the map at the recommended contour level (3.74).



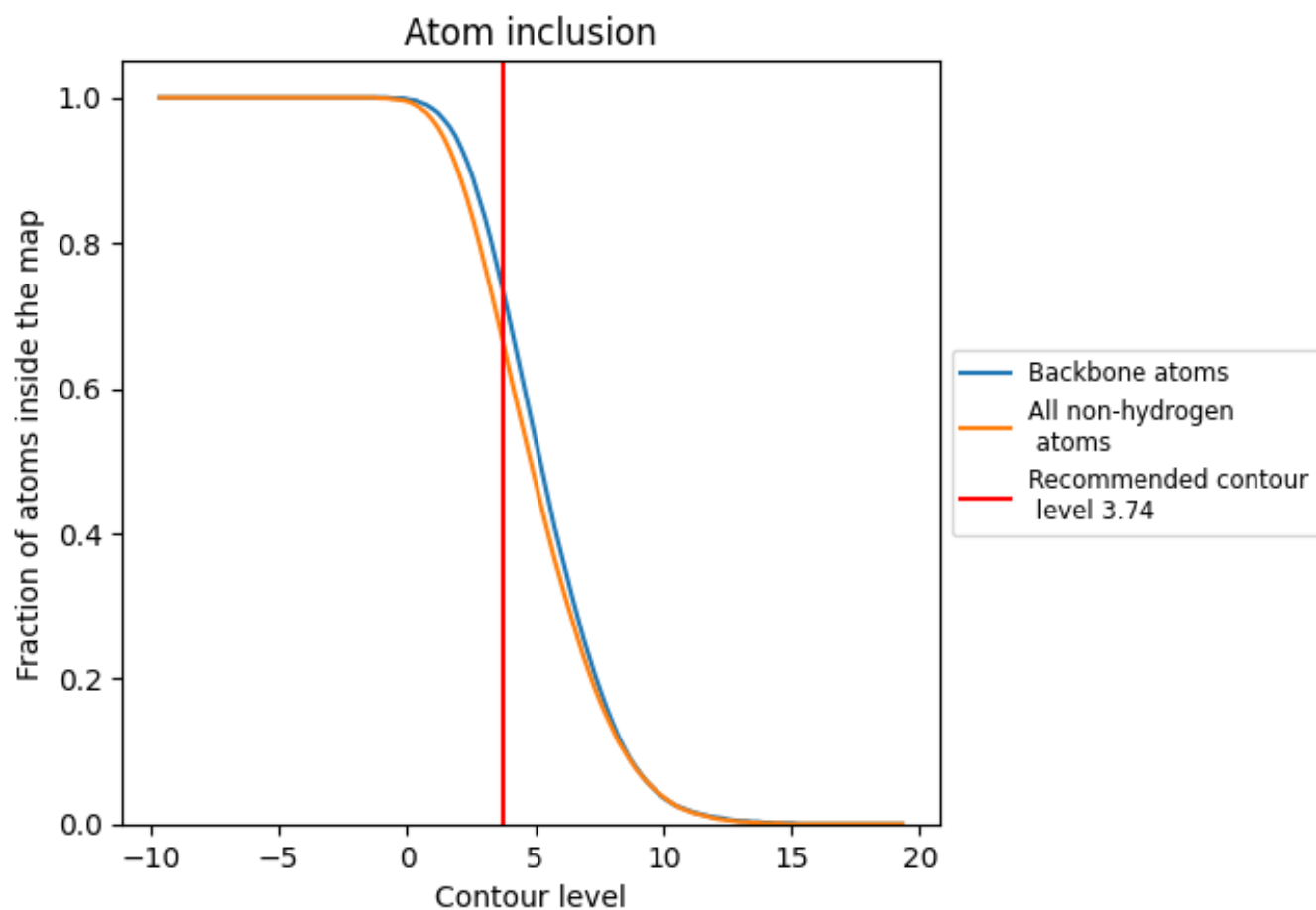



































































9.4 Atom inclusion [i](#)



At the recommended contour level, 74% of all backbone atoms, 66% of all non-hydrogen atoms, are inside the map.

9.5 Map-model fit summary





















































































The table lists the average atom inclusion at the recommended contour level (3.74) and Q-score for the entire model and for each chain.

Chain	Atom inclusion	Q-score
All	 0.6650	 0.5210
LA	 0.7600	 0.5890
LB	 0.7430	 0.5740
LC	 0.7010	 0.5640
LD	 0.8600	 0.5680
LE	 0.8460	 0.5520
LF	 0.6370	 0.5300
LG	 0.7250	 0.5820
LH	 0.6250	 0.5430
LI	 0.6690	 0.5520
LJ	 0.6530	 0.5520
LK	 0.3790	 0.5020
LL	 0.5530	 0.5150
LM	 0.7030	 0.5640
LN	 0.6460	 0.5380
LO	 0.8000	 0.5940
LP	 0.7130	 0.5610
LQ	 0.7070	 0.5610
LR	 0.6890	 0.5650
LS	 0.6080	 0.5410
LT	 0.7110	 0.5620
LU	 0.6880	 0.5630
LV	 0.5030	 0.4820
LW	 0.6620	 0.5680
LX	 0.6360	 0.5380
LY	 0.7290	 0.5730
LZ	 0.7160	 0.5600
La	 0.5760	 0.5180
Lb	 0.7710	 0.5880
Lc	 0.6760	 0.5450
Ld	 0.5690	 0.5240
Le	 0.6740	 0.5590
Lf	 0.7130	 0.5680
Lg	 0.7210	 0.5790
Lh	 0.6420	 0.5510







Continued on next page...

Continued from previous page...

Chain	Atom inclusion	Q-score
Li	 0.6960	 0.5590
Lj	 0.6420	 0.5490
Lk	 0.7510	 0.5830
Ll	 0.5180	 0.4730
Ln	 0.1210	 0.3160
Lo	 0.6560	 0.5610
Lp	 0.7320	 0.5870
Lq	 0.7200	 0.5850
Ls	 0.6910	 0.5240
Lt	 0.8160	 0.5560
Lu	 0.5770	 0.4630
SA	 0.3410	 0.4300
SB	 0.5190	 0.4960
SC	 0.4640	 0.4820
SD	 0.5500	 0.5000
SE	 0.4380	 0.4750
SF	 0.4560	 0.4620
SG	 0.2830	 0.4200
SH	 0.2630	 0.4270
SI	 0.4980	 0.5070
SJ	 0.5110	 0.5040
SK	 0.4460	 0.4730
SL	 0.4550	 0.4240
SM	 0.5240	 0.5270
SO	 0.5480	 0.5440
SP	 0.4870	 0.4910
SQ	 0.5830	 0.5360
SR	 0.4050	 0.4620
ST	 0.4190	 0.4580
SU	 0.4290	 0.4470
SV	 0.3880	 0.4150
SW	 0.3970	 0.4430
SX	 0.3620	 0.4410
SY	 0.3860	 0.4500
Sb	 0.2970	 0.4140
Sc	 0.3600	 0.4280
Sd	 0.5720	 0.5280
Se	 0.2880	 0.4380
Sg	 0.3690	 0.4650
Sh	 0.5300	 0.5060
Sj	 0.3760	 0.4660
St	 0.6830	 0.4870

Continued on next page...

Continued from previous page...

Chain	Atom inclusion	Q-score
a	 0.3680	 0.4460
y	 0.2630	 0.3370