



Full wwPDB X-ray Structure Validation Report ⓘ

Dec 18, 2023 – 06:27 am GMT

PDB ID : 4BN5
Title : Structure of human SIRT3 in complex with SRT1720 inhibitor
Authors : Nguyen, G.T.T.; Schaefer, S.; Gertz, M.; Weyand, M.; Steegborn, C.
Deposited on : 2013-05-13
Resolution : 3.25 Å(reported)

This is a Full wwPDB X-ray Structure Validation Report for a publicly released PDB entry.

We welcome your comments at validation@mail.wwpdb.org

A user guide is available at

<https://www.wwpdb.org/validation/2017/XrayValidationReportHelp>

with specific help available everywhere you see the ⓘ symbol.

The types of validation reports are described at

<http://www.wwpdb.org/validation/2017/FAQs#types>.

The following versions of software and data (see [references ⓘ](#)) were used in the production of this report:

MolProbity : 4.02b-467
Mogul : 1.8.4, CSD as541be (2020)
Xtriage (Phenix) : 1.13
EDS : 2.36
buster-report : 1.1.7 (2018)
Percentile statistics : 20191225.v01 (using entries in the PDB archive December 25th 2019)
Refmac : 5.8.0158
CCP4 : 7.0.044 (Gargrove)
Ideal geometry (proteins) : Engh & Huber (2001)
Ideal geometry (DNA, RNA) : Parkinson et al. (1996)
Validation Pipeline (wwPDB-VP) : 2.36

1 Overall quality at a glance

The following experimental techniques were used to determine the structure:

X-RAY DIFFRACTION

The reported resolution of this entry is 3.25 Å.

Percentile scores (ranging between 0-100) for global validation metrics of the entry are shown in the following graphic. The table shows the number of entries on which the scores are based.

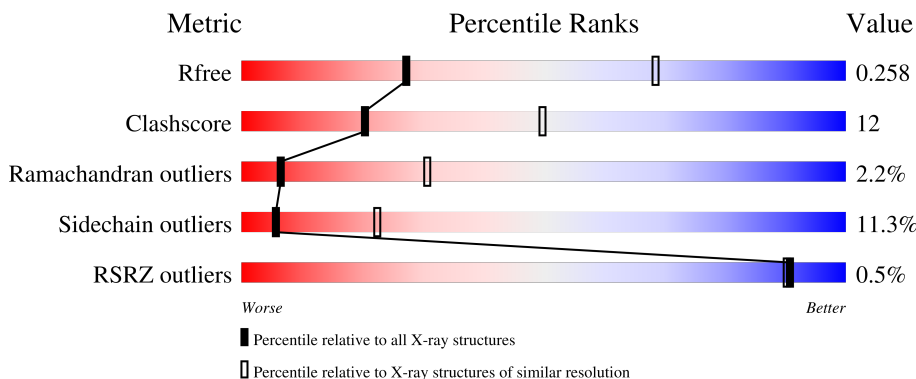

Metric	Whole archive (#Entries)	Similar resolution (#Entries, resolution range(Å))
R_{free}	130704	1191 (3.30-3.22)
Clashscore	141614	1251 (3.30-3.22)
Ramachandran outliers	138981	1229 (3.30-3.22)
Sidechain outliers	138945	1228 (3.30-3.22)
RSRZ outliers	127900	1154 (3.30-3.22)

The table below summarises the geometric issues observed across the polymeric chains and their fit to the electron density. The red, orange, yellow and green segments of the lower bar indicate the fraction of residues that contain outliers for ≥ 3 , 2, 1 and 0 types of geometric quality criteria respectively. A grey segment represents the fraction of residues that are not modelled. The numeric value for each fraction is indicated below the corresponding segment, with a dot representing fractions $\leq 5\%$. The upper red bar (where present) indicates the fraction of residues that have poor fit to the electron density. The numeric value is given above the bar.

Mol	Chain	Length	Quality of chain
1	A	281	 61% 30% 5% ..
1	B	281	 66% 24% 6% ..
1	C	281	 63% 30% ..
1	D	281	 64% 26% 5% ..
1	E	281	 70% 23% ..

Continued on next page...

Continued from previous page...

Mol	Chain	Length	Quality of chain
1	F	281	
1	G	281	
1	H	281	
1	I	281	
1	J	281	
1	K	281	
1	L	281	

The following table lists non-polymeric compounds, carbohydrate monomers and non-standard residues in protein, DNA, RNA chains that are outliers for geometric or electron-density-fit criteria:

Mol	Type	Chain	Res	Chirality	Geometry	Clashes	Electron density
3	SR7	F	1396	-	-	X	-
3	SR7	G	1396	-	-	X	-
3	SR7	H	1396	-	-	X	-
3	SR7	I	1396	-	-	X	-

2 Entry composition [i](#)

There are 5 unique types of molecules in this entry. The entry contains 26520 atoms, of which 0 are hydrogens and 0 are deuteriums.

In the tables below, the ZeroOcc column contains the number of atoms modelled with zero occupancy, the AltConf column contains the number of residues with at least one atom in alternate conformation and the Trace column contains the number of residues modelled with at most 2 atoms.

- Molecule 1 is a protein called NAD-DEPENDENT PROTEIN DEACETYLASE SIRTUIN-3, MITOCHONDRIAL.

Mol	Chain	Residues	Atoms					ZeroOcc	AltConf	Trace
			Total	C	N	O	S			
1	A	273	Total 2144	C 1382	N 369	O 384	S 9	0	0	0
1	B	273	Total 2144	C 1382	N 369	O 384	S 9	0	0	0
1	C	273	Total 2131	C 1372	N 369	O 381	S 9	0	0	0
1	D	272	Total 2059	C 1330	N 346	O 374	S 9	0	0	0
1	E	273	Total 2096	C 1356	N 353	O 378	S 9	0	0	0
1	F	273	Total 2144	C 1382	N 369	O 384	S 9	0	0	0
1	G	273	Total 2144	C 1382	N 369	O 384	S 9	0	0	0
1	H	273	Total 2144	C 1382	N 369	O 384	S 9	0	0	0
1	I	273	Total 2120	C 1369	N 361	O 381	S 9	0	0	0
1	J	273	Total 2144	C 1382	N 369	O 384	S 9	0	0	0
1	K	273	Total 2144	C 1382	N 369	O 384	S 9	0	0	0
1	L	273	Total 2134	C 1377	N 366	O 382	S 9	0	0	0

- Molecule 2 is CARBA-NICOTINAMIDE-ADENINE-DINUCLEOTIDE (three-letter code: CNA) (formula: $C_{22}H_{30}N_7O_{13}P_2$).

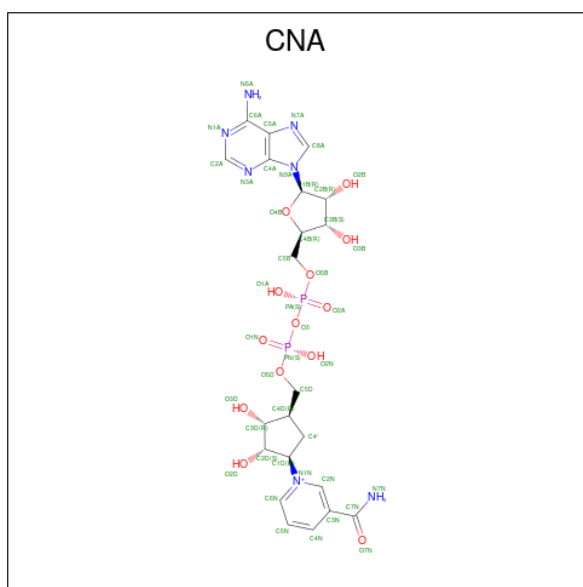

Mol	Chain	Residues	Atoms				ZeroOcc	AltConf		
			Total	C	N	O			P	
2	A	1	Total	44	22	7	13	2	0	0
2	B	1	Total	44	22	7	13	2	0	0
2	C	1	Total	44	22	7	13	2	0	0
2	D	1	Total	44	22	7	13	2	0	0
2	E	1	Total	44	22	7	13	2	0	0
2	F	1	Total	44	22	7	13	2	0	0
2	G	1	Total	44	22	7	13	2	0	0
2	H	1	Total	44	22	7	13	2	0	0
2	I	1	Total	44	22	7	13	2	0	0
2	J	1	Total	44	22	7	13	2	0	0
2	K	1	Total	44	22	7	13	2	0	0
2	L	1	Total	44	22	7	13	2	0	0

- Molecule 3 is N-{2-[3-(piperazin-1-ylmethyl)imidazo[2,1-b][1,3]thiazol-6-yl]phenyl}quinoxaline-2-carboxamide (three-letter code: SR7) (formula: C₂₅H₂₃N₇OS).

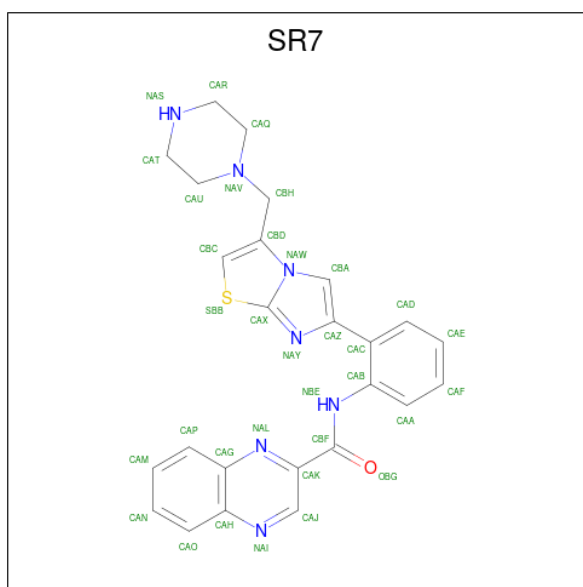

Mol	Chain	Residues	Atoms					ZeroOcc	AltConf
			Total	C	N	O	S		
3	A	1	Total	C	N	O	S	0	0
			34	25	7	1	1		
3	B	1	Total	C	N	O	S	0	0
			34	25	7	1	1		
3	C	1	Total	C	N	O	S	0	0
			34	25	7	1	1		
3	D	1	Total	C	N	O	S	0	0
			34	25	7	1	1		
3	E	1	Total	C	N	O	S	0	0
			34	25	7	1	1		
3	F	1	Total	C	N	O	S	0	0
			34	25	7	1	1		
3	G	1	Total	C	N	O	S	0	0
			34	25	7	1	1		
3	H	1	Total	C	N	O	S	0	0
			34	25	7	1	1		
3	I	1	Total	C	N	O	S	0	0
			34	25	7	1	1		
3	J	1	Total	C	N	O	S	0	0
			34	25	7	1	1		
3	K	1	Total	C	N	O	S	0	0
			34	25	7	1	1		
3	L	1	Total	C	N	O	S	0	0
			34	25	7	1	1		

- Molecule 4 is ZINC ION (three-letter code: ZN) (formula: Zn).

Mol	Chain	Residues	Atoms	ZeroOcc	AltConf
4	A	1	Total Zn 1 1	0	0
4	B	1	Total Zn 1 1	0	0
4	C	1	Total Zn 1 1	0	0
4	D	1	Total Zn 1 1	0	0
4	E	1	Total Zn 1 1	0	0
4	F	1	Total Zn 1 1	0	0
4	G	1	Total Zn 1 1	0	0
4	H	1	Total Zn 1 1	0	0
4	I	1	Total Zn 1 1	0	0
4	J	1	Total Zn 1 1	0	0
4	K	1	Total Zn 1 1	0	0
4	L	1	Total Zn 1 1	0	0

- Molecule 5 is GLYCEROL (three-letter code: GOL) (formula: $C_3H_8O_3$).

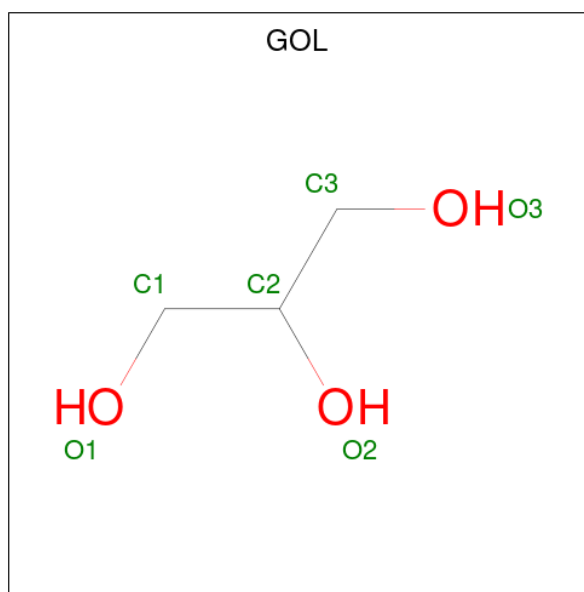

Mol	Chain	Residues	Atoms			ZeroOcc	AltConf
5	C	1	Total 6	C 3	O 3	0	0
5	D	1	Total 6	C 3	O 3	0	0
5	K	1	Total 6	C 3	O 3	0	0
5	L	1	Total 6	C 3	O 3	0	0

3 Residue-property plots

These plots are drawn for all protein, RNA, DNA and oligosaccharide chains in the entry. The first graphic for a chain summarises the proportions of the various outlier classes displayed in the second graphic. The second graphic shows the sequence view annotated by issues in geometry and electron density. Residues are color-coded according to the number of geometric quality criteria for which they contain at least one outlier: green = 0, yellow = 1, orange = 2 and red = 3 or more. A red dot above a residue indicates a poor fit to the electron density ($RSRZ > 2$). Stretches of 2 or more consecutive residues without any outlier are shown as a green connector. Residues present in the sample, but not in the model, are shown in grey.

• Molecule 1: NAD-DEPENDENT PROTEIN DEACETYLASE SIRTUIN-3, MITOCHONDRIAL

Chain A: 

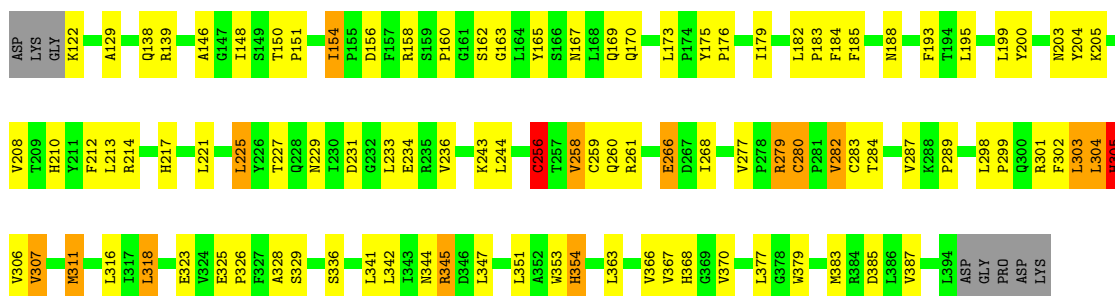

• Molecule 1: NAD-DEPENDENT PROTEIN DEACETYLASE SIRTUIN-3, MITOCHONDRIAL

Chain B: 

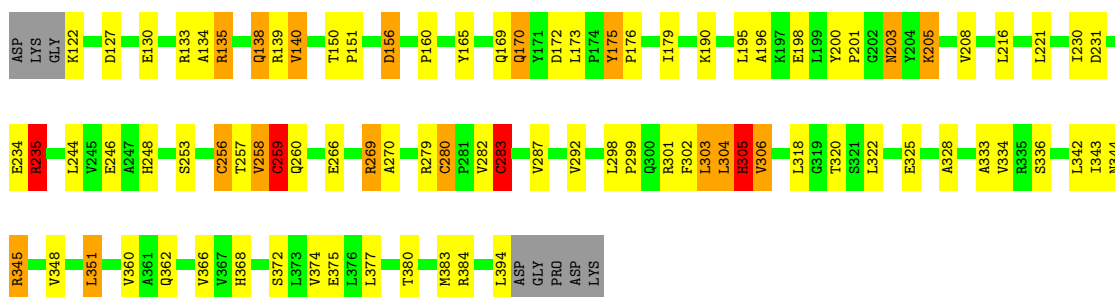

• Molecule 1: NAD-DEPENDENT PROTEIN DEACETYLASE SIRTUIN-3, MITOCHONDRIAL

Chain C: 

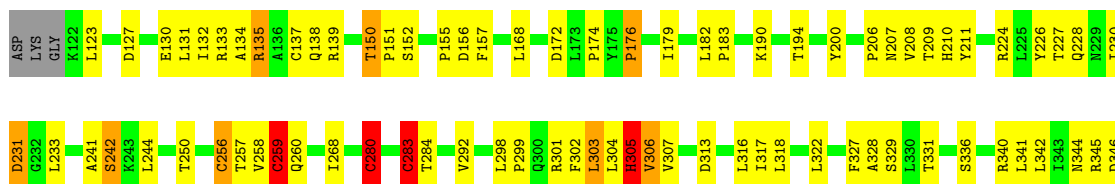



- Molecule 1: NAD-DEPENDENT PROTEIN DEACETYLASE SIRTUIN-3, MITOCHONDRIAL

Chain D: 64% 26% 5% ..

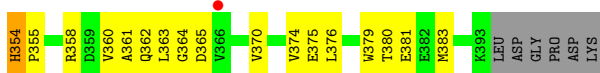

- Molecule 1: NAD-DEPENDENT PROTEIN DEACETYLASE SIRTUIN-3, MITOCHONDRIAL

Chain E: 70% 23% ..

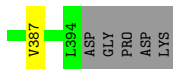

- Molecule 1: NAD-DEPENDENT PROTEIN DEACETYLASE SIRTUIN-3, MITOCHONDRIAL

Chain F: 68% 24% ..

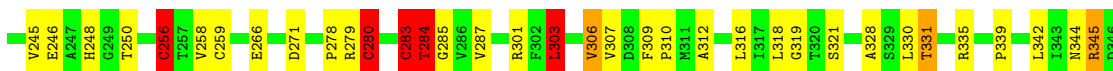

- Molecule 1: NAD-DEPENDENT PROTEIN DEACETYLASE SIRTUIN-3, MITOCHONDRIAL

Chain G: 72% 20% ..

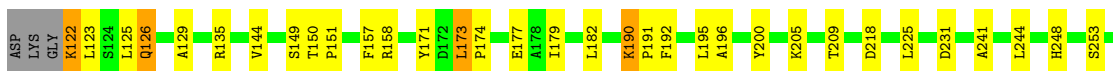

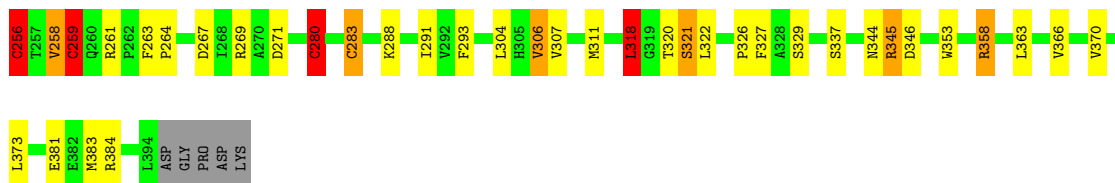

- Molecule 1: NAD-DEPENDENT PROTEIN DEACETYLASE SIRTUIN-3, MITOCHONDRIAL

Chain H: 68% 24% . . .

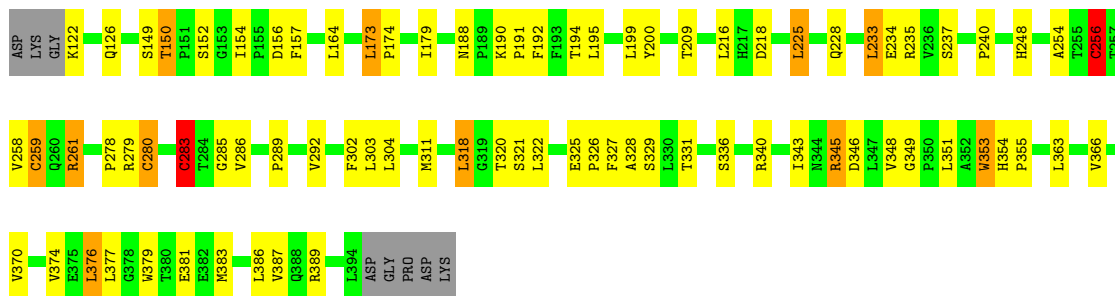

- Molecule 1: NAD-DEPENDENT PROTEIN DEACETYLASE SIRTUIN-3, MITOCHONDRIAL

Chain I: 72% 21% . . .

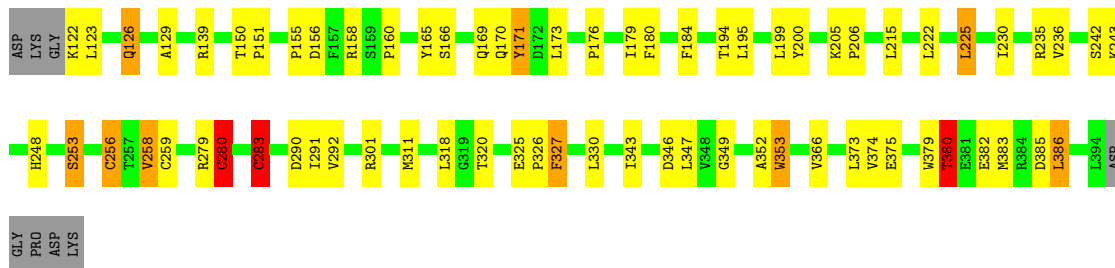

- Molecule 1: NAD-DEPENDENT PROTEIN DEACETYLASE SIRTUIN-3, MITOCHONDRIAL

Chain J: 72% 22% . .

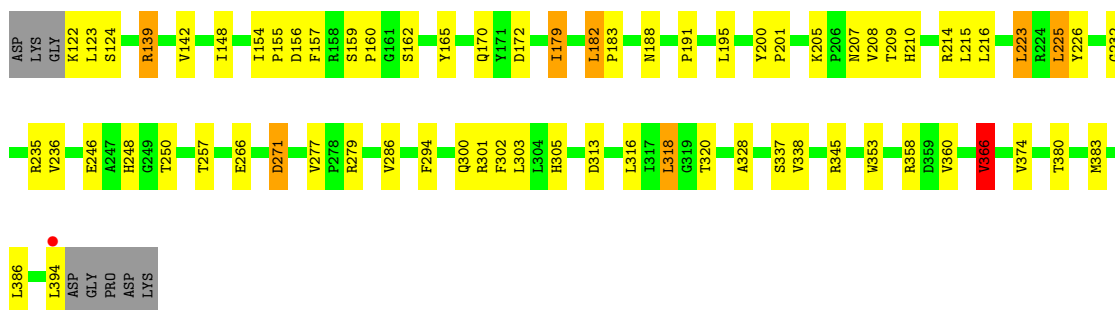

- Molecule 1: NAD-DEPENDENT PROTEIN DEACETYLASE SIRTUIN-3, MITOCHONDRIAL

Chain K: 2% 64% 28% . . .



● Molecule 1: NAD-DEPENDENT PROTEIN DEACETYLASE SIRTIUIN-3, MITOCHONDRIAL

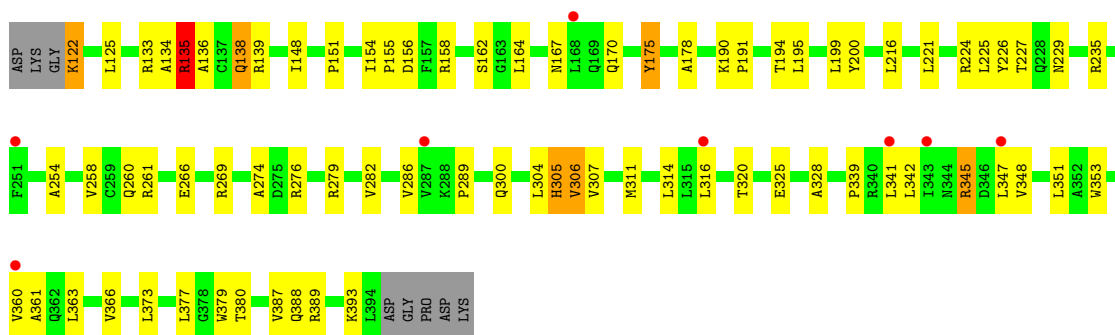

4 Data and refinement statistics

Property	Value	Source
Space group	C 1 2 1	Depositor
Cell constants a, b, c, α , β , γ	227.82Å 246.06Å 127.34Å 90.00° 123.88° 90.00°	Depositor
Resolution (Å)	48.57 – 3.25 48.57 – 3.25	Depositor EDS
% Data completeness (in resolution range)	99.8 (48.57-3.25) 99.4 (48.57-3.25)	Depositor EDS
R_{merge}	0.14	Depositor
R_{sym}	(Not available)	Depositor
$\langle I/\sigma(I) \rangle$ ¹	1.72 (at 3.25Å)	Xtrriage
Refinement program	REFMAC 5.7.0032	Depositor
R, R_{free}	0.208 , 0.265 0.203 , 0.258	Depositor DCC
R_{free} test set	4558 reflections (5.00%)	wwPDB-VP
Wilson B-factor (Å ²)	85.3	Xtrriage
Anisotropy	0.181	Xtrriage
Bulk solvent k_{sol} (e/Å ³), B_{sol} (Å ²)	0.30 , 45.7	EDS
L-test for twinning ²	$\langle L \rangle = 0.48$, $\langle L^2 \rangle = 0.30$	Xtrriage
Estimated twinning fraction	0.428 for -h-2*1,-k,l	Xtrriage
F_o, F_c correlation	0.95	EDS
Total number of atoms	26520	wwPDB-VP
Average B, all atoms (Å ²)	99.0	wwPDB-VP

Xtrriage's analysis on translational NCS is as follows: *The largest off-origin peak in the Patterson function is 2.99% of the height of the origin peak. No significant pseudotranslation is detected.*

¹Intensities estimated from amplitudes.

²Theoretical values of $\langle |L| \rangle$, $\langle L^2 \rangle$ for acentric reflections are 0.5, 0.333 respectively for untwinned datasets, and 0.375, 0.2 for perfectly twinned datasets.

5 Model quality [i](#)

5.1 Standard geometry [i](#)

Bond lengths and bond angles in the following residue types are not validated in this section: GOL, SR7, ZN, CNA

The Z score for a bond length (or angle) is the number of standard deviations the observed value is removed from the expected value. A bond length (or angle) with $|Z| > 5$ is considered an outlier worth inspection. RMSZ is the root-mean-square of all Z scores of the bond lengths (or angles).

Mol	Chain	Bond lengths		Bond angles	
		RMSZ	# Z >5	RMSZ	# Z >5
1	A	0.74	0/2199	0.92	8/2996 (0.3%)
1	B	0.72	0/2199	0.90	4/2996 (0.1%)
1	C	0.69	1/2184 (0.0%)	0.90	5/2975 (0.2%)
1	D	0.73	3/2110 (0.1%)	0.89	3/2883 (0.1%)
1	E	0.57	0/2150	0.79	0/2938
1	F	0.59	0/2199	0.80	6/2996 (0.2%)
1	G	0.62	1/2199 (0.0%)	0.84	5/2996 (0.2%)
1	H	0.56	0/2199	0.80	4/2996 (0.1%)
1	I	0.58	1/2175 (0.0%)	0.78	4/2968 (0.1%)
1	J	0.56	0/2199	0.77	2/2996 (0.1%)
1	K	0.48	0/2199	0.69	0/2996
1	L	0.49	0/2189	0.70	0/2984
All	All	0.62	6/26201 (0.0%)	0.82	41/35720 (0.1%)

Chiral center outliers are detected by calculating the chiral volume of a chiral center and verifying if the center is modelled as a planar moiety or with the opposite hand. A planarity outlier is detected by checking planarity of atoms in a peptide group, atoms in a mainchain group or atoms of a sidechain that are expected to be planar.

Mol	Chain	#Chirality outliers	#Planarity outliers
1	A	0	1
1	B	0	2
1	D	0	2
1	E	0	2
1	K	0	2
1	L	0	1
All	All	0	10

All (6) bond length outliers are listed below:

Mol	Chain	Res	Type	Atoms	Z	Observed(Å)	Ideal(Å)
1	D	365	ASP	CB-CG	7.46	1.67	1.51
1	C	259	CYS	CB-SG	5.79	1.92	1.82
1	I	259	CYS	CB-SG	5.51	1.91	1.82
1	D	177	GLU	CG-CD	5.22	1.59	1.51
1	G	259	CYS	CB-SG	5.13	1.91	1.82
1	D	259	CYS	CB-SG	5.02	1.90	1.82

All (41) bond angle outliers are listed below:

Mol	Chain	Res	Type	Atoms	Z	Observed(°)	Ideal(°)
1	A	280	CYS	CA-CB-SG	8.93	130.08	114.00
1	C	280	CYS	CA-CB-SG	8.37	129.07	114.00
1	D	280	CYS	CA-CB-SG	8.32	128.98	114.00
1	B	280	CYS	CA-CB-SG	7.87	128.17	114.00
1	A	256	CYS	CA-CB-SG	7.76	127.97	114.00
1	G	280	CYS	CA-CB-SG	7.68	127.83	114.00
1	I	259	CYS	CA-CB-SG	7.46	127.44	114.00
1	C	259	CYS	CA-CB-SG	7.30	127.15	114.00
1	F	280	CYS	CA-CB-SG	7.25	127.05	114.00
1	B	235	ARG	NE-CZ-NH1	6.91	123.75	120.30
1	H	259	CYS	CA-CB-SG	6.90	126.42	114.00
1	I	256	CYS	CA-CB-SG	6.88	126.39	114.00
1	H	280	CYS	CA-CB-SG	6.83	126.30	114.00
1	B	259	CYS	CA-CB-SG	6.67	126.00	114.00
1	A	345	ARG	NE-CZ-NH1	6.64	123.62	120.30
1	D	259	CYS	CA-CB-SG	6.39	125.50	114.00
1	G	259	CYS	CA-CB-SG	6.36	125.45	114.00
1	H	256	CYS	CA-CB-SG	6.33	125.40	114.00
1	A	231	ASP	CB-CG-OD2	-6.28	112.65	118.30
1	F	256	CYS	CA-CB-SG	6.21	125.17	114.00
1	C	176	PRO	N-CA-CB	6.06	110.57	103.30
1	G	256	CYS	CA-CB-SG	6.04	124.88	114.00
1	A	231	ASP	CB-CG-OD1	6.02	123.72	118.30
1	I	283	CYS	CA-CB-SG	5.98	124.76	114.00
1	F	366	VAL	CB-CA-C	-5.93	100.13	111.40
1	B	283	CYS	CA-CB-SG	5.88	124.58	114.00
1	A	345	ARG	NE-CZ-NH2	-5.87	117.37	120.30
1	D	235	ARG	NE-CZ-NH1	5.86	123.23	120.30
1	J	366	VAL	CB-CA-C	-5.84	100.31	111.40
1	F	345	ARG	N-CA-CB	5.72	120.89	110.60
1	H	283	CYS	CA-CB-SG	5.71	124.28	114.00
1	I	280	CYS	CA-CB-SG	5.59	124.06	114.00
1	A	305	HIS	N-CA-C	-5.59	95.91	111.00

Continued on next page...

Continued from previous page...

Mol	Chain	Res	Type	Atoms	Z	Observed(°)	Ideal(°)
1	G	135	ARG	NE-CZ-NH1	5.59	123.09	120.30
1	F	283	CYS	CA-CB-SG	5.51	123.92	114.00
1	J	318	LEU	CA-CB-CG	5.46	127.86	115.30
1	G	318	LEU	CA-CB-CG	5.39	127.70	115.30
1	A	303	LEU	CA-CB-CG	5.33	127.56	115.30
1	F	303	LEU	CA-CB-CG	5.31	127.51	115.30
1	C	305	HIS	CB-CA-C	5.17	120.74	110.40
1	C	283	CYS	CA-CB-SG	5.12	123.22	114.00

There are no chirality outliers.

All (10) planarity outliers are listed below:

Mol	Chain	Res	Type	Group
1	A	304	LEU	Peptide
1	B	283	CYS	Peptide
1	B	304	LEU	Peptide
1	D	304	LEU	Peptide
1	D	305	HIS	Peptide
1	E	303	LEU	Peptide
1	E	305	HIS	Peptide
1	K	170	GLN	Peptide
1	K	304	LEU	Peptide
1	L	170	GLN	Peptide

5.2 Too-close contacts [i](#)

In the following table, the Non-H and H(model) columns list the number of non-hydrogen atoms and hydrogen atoms in the chain respectively. The H(added) column lists the number of hydrogen atoms added and optimized by MolProbity. The Clashes column lists the number of clashes within the asymmetric unit, whereas Symm-Clashes lists symmetry-related clashes.

Mol	Chain	Non-H	H(model)	H(added)	Clashes	Symm-Clashes
1	A	2144	0	2160	80	0
1	B	2144	0	2160	76	0
1	C	2131	0	2143	66	0
1	D	2059	0	2025	70	0
1	E	2096	0	2079	39	1
1	F	2144	0	2160	50	0
1	G	2144	0	2160	41	0
1	H	2144	0	2160	52	0
1	I	2120	0	2117	34	0

Continued on next page...

Continued from previous page...

Mol	Chain	Non-H	H(model)	H(added)	Clashes	Symm-Clashes
1	J	2144	0	2160	32	0
1	K	2144	0	2160	58	0
1	L	2134	0	2145	45	0
2	A	44	0	29	5	0
2	B	44	0	29	4	0
2	C	44	0	29	1	0
2	D	44	0	29	5	0
2	E	44	0	29	1	0
2	F	44	0	29	3	0
2	G	44	0	29	12	0
2	H	44	0	29	11	0
2	I	44	0	29	5	0
2	J	44	0	29	4	0
2	K	44	0	29	6	0
2	L	44	0	29	5	0
3	A	34	0	23	4	0
3	B	34	0	23	5	0
3	C	34	0	23	4	0
3	D	34	0	23	2	0
3	E	34	0	23	5	0
3	F	34	0	23	11	0
3	G	34	0	23	18	0
3	H	34	0	23	12	0
3	I	34	0	23	10	0
3	J	34	0	23	7	0
3	K	34	0	23	8	0
3	L	34	0	23	6	0
4	A	1	0	0	0	0
4	B	1	0	0	0	0
4	C	1	0	0	0	0
4	D	1	0	0	0	0
4	E	1	0	0	0	0
4	F	1	0	0	0	0
4	G	1	0	0	0	0
4	H	1	0	0	0	0
4	I	1	0	0	0	0
4	J	1	0	0	0	0
4	K	1	0	0	0	0
4	L	1	0	0	0	0
5	C	6	0	8	2	0
5	D	6	0	8	3	0
5	K	6	0	8	1	0

Continued on next page...

Continued from previous page...

Mol	Chain	Non-H	H(model)	H(added)	Clashes	Symm-Clashes
5	L	6	0	8	0	0
All	All	26520	0	26285	656	1

The all-atom clashscore is defined as the number of clashes found per 1000 atoms (including hydrogen atoms). The all-atom clashscore for this structure is 12.

All (656) close contacts within the same asymmetric unit are listed below, sorted by their clash magnitude.

Atom-1	Atom-2	Interatomic distance (Å)	Clash overlap (Å)
1:C:305:HIS:CE1	1:D:305:HIS:CE1	1.88	1.58
1:A:305:HIS:CE1	1:B:305:HIS:NE2	1.85	1.43
1:A:305:HIS:NE2	1:B:305:HIS:NE2	1.68	1.36
1:C:305:HIS:NE2	1:D:305:HIS:CE1	1.84	1.35
1:A:305:HIS:NE2	1:B:305:HIS:CE1	1.96	1.31
1:C:305:HIS:NE2	1:D:305:HIS:NE2	1.91	1.18
2:A:1395:CNA:O2N	2:A:1395:CNA:H17	1.50	1.09
2:G:1395:CNA:C6N	3:G:1396:SR7:NAI	2.18	1.07
1:H:349:GLY:O	1:H:353:TRP:CD1	2.10	1.04
1:C:305:HIS:HE1	1:D:305:HIS:CE1	1.72	0.99
2:H:1395:CNA:C6N	3:H:1396:SR7:HAP	1.94	0.97
2:H:1395:CNA:C5N	3:H:1396:SR7:HAP	1.95	0.95
1:H:157:PHE:CE1	1:H:179:ILE:HD13	2.03	0.94
1:G:157:PHE:HE1	3:G:1396:SR7:NAL	1.67	0.93
1:K:305:HIS:CE1	1:L:305:HIS:NE2	2.36	0.93
1:A:280:CYS:SG	1:A:283:CYS:N	2.41	0.92
1:G:157:PHE:CE1	3:G:1396:SR7:NAL	2.38	0.92
2:G:1395:CNA:C3N	3:G:1396:SR7:HAO	2.03	0.88
1:C:305:HIS:CE1	1:D:305:HIS:HE1	1.70	0.88
2:J:1395:CNA:H17	2:J:1395:CNA:O2N	1.73	0.87
1:K:305:HIS:NE2	1:L:305:HIS:NE2	2.22	0.87
1:C:155:PRO:O	3:C:1397:SR7:HAM	1.72	0.86
1:D:342:LEU:HD22	1:D:351:LEU:HD12	1.58	0.85
1:J:142:VAL:HG12	1:J:316:LEU:HB3	1.59	0.85
1:C:305:HIS:CE1	1:D:305:HIS:ND1	2.44	0.84
1:A:306:VAL:HG21	1:B:306:VAL:HG21	1.60	0.83
1:G:261:ARG:HG3	1:H:218:ASP:O	1.81	0.79
1:C:302:PHE:O	1:C:305:HIS:HB3	1.84	0.78
1:D:342:LEU:HD11	1:D:344:ASN:HB2	1.66	0.78
1:H:325:GLU:OE1	1:H:326:PRO:HA	1.84	0.77
1:A:138:GLN:HA	1:A:221:LEU:HD23	1.65	0.77
1:A:279:ARG:HG3	1:A:284:THR:C	2.07	0.75

Continued on next page...

Continued from previous page...

Atom-1	Atom-2	Interatomic distance (Å)	Clash overlap (Å)
1:I:156:ASP:HA	3:I:1396:SR7:HAP	1.67	0.75
1:H:280:CYS:SG	1:H:283:CYS:N	2.58	0.75
2:G:1395:CNA:N1N	3:G:1396:SR7:NAI	2.35	0.74
1:K:305:HIS:NE2	1:L:305:HIS:CE1	2.56	0.74
1:F:256:CYS:HA	1:F:287:VAL:HA	1.69	0.74
1:F:208:VAL:HG11	1:F:367:VAL:HG13	1.69	0.74
2:I:1395:CNA:O3D	3:I:1396:SR7:NAY	2.18	0.74
1:E:156:ASP:HA	3:E:1396:SR7:HAP	1.69	0.73
2:G:1395:CNA:C4N	3:G:1396:SR7:HAO	2.18	0.73
1:C:322:LEU:HD13	1:C:331:THR:HG21	1.68	0.73
1:K:122:LYS:HE3	1:K:122:LYS:HA	1.71	0.73
1:B:156:ASP:HA	3:B:1396:SR7:HAP	1.69	0.72
1:F:256:CYS:SG	1:F:259:CYS:N	2.61	0.72
1:D:280:CYS:SG	1:D:283:CYS:N	2.62	0.72
1:H:349:GLY:O	1:H:353:TRP:NE1	2.23	0.72
1:C:301:ARG:HG2	5:C:1396:GOL:H11	1.71	0.72
2:A:1395:CNA:O2N	2:A:1395:CNA:C4D	2.34	0.71
1:C:301:ARG:O	1:C:304:LEU:HD12	1.90	0.71
1:H:318:LEU:HD13	1:H:343:ILE:HB	1.72	0.71
1:A:304:LEU:HD23	1:C:303:LEU:HD12	1.73	0.71
1:A:279:ARG:HG3	1:A:284:THR:O	1.91	0.70
1:G:149:SER:OG	1:G:231:ASP:OD2	2.05	0.70
1:H:292:VAL:O	3:H:1396:SR7:HBHA	1.92	0.70
1:J:157:PHE:CZ	1:J:179:ILE:HD11	2.26	0.70
1:K:156:ASP:HA	3:K:1397:SR7:HAP	1.73	0.69
1:A:256:CYS:SG	1:A:259:CYS:N	2.65	0.69
1:B:280:CYS:SG	1:B:283:CYS:N	2.65	0.69
1:K:137:CYS:HA	1:K:313:ASP:OD2	1.92	0.69
2:H:1395:CNA:H21	3:H:1396:SR7:CAZ	2.06	0.69
1:H:366:VAL:HG23	2:H:1395:CNA:N1A	2.07	0.69
1:F:280:CYS:SG	1:F:283:CYS:N	2.64	0.68
2:I:1395:CNA:H21	3:I:1396:SR7:CAX	2.06	0.68
1:I:199:LEU:HD11	3:I:1396:SR7:HAN	1.76	0.68
1:F:171:TYR:O	1:F:172:ASP:C	2.32	0.68
1:A:305:HIS:HE1	1:B:305:HIS:NE2	1.81	0.68
1:I:280:CYS:SG	1:I:283:CYS:N	2.65	0.67
1:D:304:LEU:O	1:D:306:VAL:N	2.27	0.67
1:D:150:THR:HG22	1:D:151:PRO:N	2.09	0.67
1:F:142:VAL:HG12	1:F:225:LEU:HD13	1.76	0.67
1:C:305:HIS:NE2	1:D:305:HIS:CD2	2.62	0.67
1:K:325:GLU:OE1	1:K:326:PRO:HA	1.95	0.67

Continued on next page...

Continued from previous page...

Atom-1	Atom-2	Interatomic distance (Å)	Clash overlap (Å)
1:L:325:GLU:OE1	1:L:328:ALA:HB3	1.95	0.67
1:D:150:THR:O	1:D:153:GLY:N	2.26	0.67
2:G:1395:CNA:H24	3:G:1396:SR7:HAJ	1.76	0.67
1:D:304:LEU:C	1:D:306:VAL:N	2.49	0.66
1:E:128:VAL:HG11	1:E:341:LEU:HD22	1.76	0.66
1:G:346:ASP:HA	1:G:363:LEU:HD22	1.75	0.66
1:K:342:LEU:HD23	1:K:347:LEU:HD12	1.78	0.66
1:J:156:ASP:HA	3:J:1396:SR7:HAP	1.78	0.66
1:B:301:ARG:HG2	5:D:1395:GOL:H2	1.78	0.66
1:I:318:LEU:HD13	1:I:343:ILE:HB	1.77	0.66
1:L:175:TYR:CE2	1:L:178:ALA:HB2	2.31	0.65
2:G:1395:CNA:H24	3:G:1396:SR7:CAJ	2.26	0.65
1:C:317:ILE:HD12	1:C:351:LEU:HD11	1.78	0.65
1:D:304:LEU:O	1:D:305:HIS:C	2.35	0.65
1:A:303:LEU:CD1	1:B:306:VAL:HG11	2.28	0.65
1:A:305:HIS:NE2	1:B:305:HIS:HE1	1.87	0.65
1:A:233:LEU:HA	1:A:236:VAL:HG12	1.78	0.64
1:J:142:VAL:HG23	1:J:225:LEU:HD13	1.79	0.64
1:B:205:LYS:HE2	1:B:394:LEU:HD22	1.79	0.64
1:G:248:HIS:CE1	3:G:1396:SR7:HARA	2.31	0.64
1:I:158:ARG:HE	3:I:1396:SR7:HAA	1.61	0.64
2:L:1395:CNA:H19	3:L:1397:SR7:NBE	2.12	0.64
1:G:280:CYS:SG	1:G:283:CYS:N	2.63	0.64
1:H:386:LEU:HA	1:H:389:ARG:HD2	1.78	0.64
1:B:303:LEU:HD23	1:D:304:LEU:HD12	1.80	0.63
1:A:156:ASP:HA	3:A:1396:SR7:HAP	1.80	0.63
1:B:134:ALA:O	1:B:135:ARG:HB2	1.97	0.63
1:C:280:CYS:SG	1:C:283:CYS:N	2.60	0.63
1:E:346:ASP:HA	1:E:363:LEU:HD22	1.80	0.63
1:E:133:ARG:O	1:E:135:ARG:N	2.31	0.63
1:A:304:LEU:O	1:A:305:HIS:C	2.37	0.62
1:H:199:LEU:HD11	3:H:1396:SR7:HAN	1.80	0.62
1:C:345:ARG:HA	1:C:364:GLY:O	1.99	0.62
1:K:303:LEU:CD1	1:L:306:VAL:HG11	2.29	0.62
1:C:342:LEU:HD22	1:C:351:LEU:HD12	1.80	0.62
3:F:1396:SR7:NAY	3:F:1396:SR7:HAJ	2.14	0.62
1:A:279:ARG:CG	1:A:284:THR:O	2.48	0.62
1:A:305:HIS:CE1	1:B:305:HIS:CD2	2.83	0.62
1:E:133:ARG:C	1:E:135:ARG:H	2.02	0.62
1:G:171:TYR:O	1:G:173:LEU:N	2.32	0.62
1:L:366:VAL:HG23	2:L:1395:CNA:C2A	2.30	0.61

Continued on next page...

Continued from previous page...

Atom-1	Atom-2	Interatomic distance (Å)	Clash overlap (Å)
2:G:1395:CNA:C6N	3:G:1396:SR7:CAJ	2.78	0.61
1:D:353:TRP:O	1:D:354:HIS:CB	2.48	0.61
1:C:156:ASP:HA	3:C:1397:SR7:HAP	1.82	0.61
1:L:135:ARG:NH1	1:L:138:GLN:HG2	2.16	0.61
1:B:342:LEU:HB2	1:B:351:LEU:HD12	1.83	0.61
1:C:346:ASP:HA	1:C:363:LEU:HD22	1.83	0.61
1:L:224:ARG:HG2	1:L:226:TYR:CE1	2.35	0.61
1:G:256:CYS:SG	1:G:259:CYS:N	2.74	0.60
1:B:345:ARG:HH11	1:B:345:ARG:HB3	1.66	0.60
1:H:188:ASN:OD1	1:H:190:LYS:N	2.33	0.60
1:B:322:LEU:HD12	1:B:348:VAL:HG23	1.82	0.60
1:E:175:TYR:CE1	1:E:178:ALA:HB2	2.36	0.60
1:H:248:HIS:CE1	3:H:1396:SR7:HARA	2.37	0.60
1:J:232:GLY:O	1:J:236:VAL:HG23	2.01	0.60
1:K:155:PRO:O	3:K:1397:SR7:HAM	2.02	0.60
1:G:218:ASP:O	1:H:261:ARG:HG3	2.01	0.60
1:K:342:LEU:HD12	1:K:343:ILE:H	1.67	0.60
1:E:292:VAL:O	3:E:1396:SR7:HBHA	2.02	0.59
1:A:304:LEU:HD23	1:C:303:LEU:CD1	2.32	0.59
2:D:1394:CNA:H19	3:D:1396:SR7:NBE	2.18	0.59
2:G:1395:CNA:H17	2:G:1395:CNA:O2N	2.02	0.59
1:K:302:PHE:O	1:K:305:HIS:HB2	2.01	0.59
1:L:279:ARG:HG2	1:L:286:VAL:HA	1.84	0.59
2:L:1395:CNA:H19	3:L:1397:SR7:HNBE	1.66	0.59
1:F:248:HIS:CE1	3:F:1396:SR7:HAR	2.37	0.59
1:F:148:ILE:HG22	1:F:209:THR:HG21	1.83	0.59
1:B:304:LEU:O	1:B:305:HIS:C	2.41	0.59
1:G:157:PHE:CE2	1:G:179:ILE:HD11	2.37	0.59
1:B:325:GLU:OE1	1:B:328:ALA:HB3	2.03	0.58
1:J:257:THR:HB	1:J:286:VAL:O	2.02	0.58
1:K:306:VAL:HG21	1:L:306:VAL:HG21	1.85	0.58
1:I:230:ILE:HD12	1:I:291:ILE:HD12	1.85	0.58
1:F:157:PHE:CZ	1:F:179:ILE:HD11	2.39	0.58
2:D:1394:CNA:H17	2:D:1394:CNA:O2N	2.03	0.58
1:B:303:LEU:HD12	1:B:303:LEU:O	2.04	0.58
1:C:301:ARG:O	1:C:304:LEU:CD1	2.51	0.58
1:D:304:LEU:C	1:D:306:VAL:H	2.05	0.58
1:F:339:PRO:HA	1:F:358:ARG:HB3	1.86	0.58
1:A:280:CYS:SG	1:A:282:VAL:HB	2.44	0.58
2:H:1395:CNA:O3D	3:H:1396:SR7:NAY	2.31	0.57
1:L:175:TYR:CD2	1:L:178:ALA:HB2	2.40	0.57

Continued on next page...

Continued from previous page...

Atom-1	Atom-2	Interatomic distance (Å)	Clash overlap (Å)
1:G:122:LYS:C	1:G:122:LYS:HE3	2.23	0.57
1:C:306:VAL:HG11	1:D:303:LEU:HD21	1.85	0.57
1:K:347:LEU:HB2	1:K:363:LEU:HD11	1.86	0.57
1:A:162:SER:O	1:A:163:GLY:C	2.43	0.57
1:D:125:LEU:HD22	1:D:362:GLN:OE1	2.04	0.57
1:D:191:PRO:O	1:D:194:THR:HB	2.04	0.57
1:A:325:GLU:OE1	1:A:328:ALA:HB3	2.05	0.56
1:E:234:GLU:CB	1:E:244:LEU:HD21	2.36	0.56
1:K:366:VAL:HG23	2:K:1395:CNA:C2A	2.35	0.56
1:E:317:ILE:C	1:E:318:LEU:HD23	2.25	0.56
1:H:173:LEU:HD13	1:H:174:PRO:HD2	1.87	0.56
1:C:304:LEU:HD12	1:C:304:LEU:H	1.70	0.56
1:H:233:LEU:N	1:H:233:LEU:HD23	2.21	0.56
2:J:1395:CNA:O2N	2:J:1395:CNA:C4D	2.52	0.56
1:C:283:CYS:O	1:C:284:THR:OG1	2.19	0.56
1:H:150:THR:HG21	2:H:1395:CNA:H11	1.71	0.56
2:H:1395:CNA:O3D	3:H:1396:SR7:CAZ	2.54	0.56
1:L:254:ALA:HA	1:L:289:PRO:HA	1.87	0.56
1:B:235:ARG:HD2	1:B:246:GLU:OE2	2.06	0.55
1:E:173:LEU:HD23	1:E:174:PRO:HD2	1.88	0.55
1:B:384:ARG:NH1	1:B:384:ARG:HB3	2.21	0.55
1:C:317:ILE:C	1:C:318:LEU:HD23	2.26	0.55
1:D:150:THR:O	1:D:152:SER:N	2.39	0.55
3:J:1396:SR7:HAJ	3:J:1396:SR7:NAY	2.21	0.55
1:A:303:LEU:HD13	1:B:306:VAL:HG11	1.87	0.55
1:K:303:LEU:HD12	1:L:306:VAL:HG11	1.86	0.55
1:C:356:ARG:N	1:C:359:ASP:OD2	2.40	0.55
1:D:256:CYS:SG	1:D:259:CYS:N	2.75	0.55
1:F:160:PRO:HA	1:F:165:TYR:CD2	2.41	0.55
2:K:1395:CNA:H19	3:K:1397:SR7:HNBE	1.72	0.55
1:C:303:LEU:O	1:C:306:VAL:HG23	2.06	0.55
2:K:1395:CNA:H19	3:K:1397:SR7:NBE	2.21	0.55
1:L:342:LEU:HD22	1:L:351:LEU:HD12	1.89	0.55
1:B:248:HIS:CD2	3:B:1396:SR7:HAR	2.41	0.55
1:D:283:CYS:HB2	1:D:285:GLY:H	1.71	0.55
1:A:138:GLN:HA	1:A:221:LEU:CD2	2.37	0.55
1:D:322:LEU:HD13	1:D:331:THR:HG21	1.89	0.54
1:K:377:LEU:HD23	1:K:379:TRP:CZ3	2.42	0.54
1:B:176:PRO:O	1:B:179:ILE:HG22	2.08	0.54
1:F:248:HIS:CE1	3:F:1396:SR7:CAR	2.90	0.54
1:K:344:ASN:HB3	1:K:346:ASP:O	2.08	0.54

Continued on next page...

Continued from previous page...

Atom-1	Atom-2	Interatomic distance (Å)	Clash overlap (Å)
1:D:179:ILE:HG22	1:D:192:PHE:HA	1.90	0.54
1:I:374:VAL:HG13	1:I:379:TRP:HB2	1.90	0.54
1:A:306:VAL:HG21	1:B:306:VAL:CG2	2.35	0.54
1:C:340:ARG:HB2	1:C:359:ASP:OD1	2.08	0.54
1:J:207:ASN:O	1:J:210:HIS:N	2.40	0.54
1:A:301:ARG:HA	5:C:1396:GOL:H2	1.90	0.54
1:A:304:LEU:C	1:A:306:VAL:N	2.61	0.53
1:C:130:GLU:HA	1:C:130:GLU:OE1	2.08	0.53
1:C:305:HIS:NE2	1:D:305:HIS:ND1	2.45	0.53
1:G:158:ARG:HG3	1:G:158:ARG:HH11	1.73	0.53
2:G:1395:CNA:O2N	2:G:1395:CNA:C4D	2.56	0.53
1:B:320:THR:HG23	1:B:322:LEU:HG	1.90	0.53
1:H:278:PRO:C	1:H:279:ARG:HG3	2.28	0.53
1:K:125:LEU:HD23	1:K:376:LEU:HD12	1.91	0.53
1:J:148:ILE:HG22	1:J:209:THR:HG21	1.90	0.53
1:J:366:VAL:HG22	2:J:1395:CNA:N1A	2.23	0.53
3:A:1396:SR7:HAJ	3:A:1396:SR7:NAY	2.23	0.53
1:D:148:ILE:O	1:D:207:ASN:ND2	2.37	0.53
1:E:214:ARG:HD3	1:E:237:SER:O	2.09	0.53
1:E:214:ARG:O	1:E:217:HIS:HB3	2.09	0.53
1:I:347:LEU:HD23	1:I:352:ALA:HB2	1.91	0.53
1:K:342:LEU:HD12	1:K:343:ILE:N	2.23	0.53
1:J:182:LEU:O	1:J:183:PRO:C	2.46	0.53
1:A:302:PHE:O	1:A:305:HIS:HB2	2.08	0.52
1:C:316:LEU:CD1	1:C:341:LEU:HD23	2.39	0.52
1:E:259:CYS:O	1:E:260:GLN:HB2	2.10	0.52
1:G:173:LEU:HD13	1:G:174:PRO:HD2	1.91	0.52
1:C:241:ALA:HA	1:C:244:LEU:HD12	1.92	0.52
1:F:310:PRO:O	1:F:335:ARG:NH2	2.43	0.52
1:D:157:PHE:CZ	1:D:179:ILE:HD11	2.44	0.52
1:E:234:GLU:HB3	1:E:244:LEU:HD21	1.90	0.52
1:B:133:ARG:NH1	1:B:377:LEU:O	2.43	0.52
1:C:317:ILE:O	1:C:342:LEU:HD12	2.09	0.52
1:D:351:LEU:O	1:D:355:PRO:HB3	2.08	0.52
1:H:188:ASN:OD1	1:H:191:PRO:HD3	2.10	0.52
1:A:176:PRO:O	1:A:179:ILE:HG22	2.10	0.52
1:I:325:GLU:OE1	1:I:326:PRO:HA	2.10	0.52
1:G:321:SER:O	1:G:322:LEU:HB2	2.09	0.52
1:L:135:ARG:NE	1:L:221:LEU:HD21	2.24	0.52
1:E:353:TRP:CD1	1:E:353:TRP:N	2.77	0.52
1:B:138:GLN:HA	1:B:221:LEU:HD23	1.90	0.51

Continued on next page...

Continued from previous page...

Atom-1	Atom-2	Interatomic distance (Å)	Clash overlap (Å)
1:A:214:ARG:O	1:A:217:HIS:HB3	2.10	0.51
1:G:157:PHE:CD1	3:G:1396:SR7:NAL	2.77	0.51
1:I:386:LEU:HD12	1:I:386:LEU:O	2.10	0.51
1:J:337:SER:O	1:J:358:ARG:HD2	2.10	0.51
1:K:350:PRO:HA	1:K:353:TRP:HB2	1.92	0.51
1:F:387:VAL:O	1:F:391:THR:OG1	2.16	0.51
1:A:305:HIS:CD2	1:B:305:HIS:CE1	2.92	0.51
1:B:248:HIS:NE2	3:B:1396:SR7:HAR	2.25	0.51
1:F:236:VAL:C	1:F:238:GLY:H	2.13	0.51
2:J:1395:CNA:H24	3:J:1396:SR7:CAJ	2.41	0.51
1:L:134:ALA:O	1:L:136:ALA:N	2.44	0.51
2:I:1395:CNA:H21	3:I:1396:SR7:CAZ	2.15	0.51
1:A:303:LEU:HG	1:C:303:LEU:HD13	1.92	0.51
1:A:316:LEU:HG	1:A:318:LEU:HD21	1.92	0.51
1:D:256:CYS:HA	1:D:287:VAL:HA	1.93	0.51
1:G:288:LYS:NZ	1:G:291:ILE:O	2.44	0.51
2:B:1395:CNA:H17	2:B:1395:CNA:O2N	2.11	0.51
1:D:339:PRO:HA	1:D:358:ARG:O	2.10	0.51
1:J:235:ARG:HD2	1:J:246:GLU:OE2	2.11	0.51
1:G:126:GLN:O	1:G:129:ALA:HB3	2.11	0.51
1:A:307:VAL:HB	1:D:307:VAL:HG12	1.92	0.50
1:C:305:HIS:HE1	1:D:305:HIS:ND1	1.99	0.50
1:J:139:ARG:HG3	1:J:223:LEU:HD22	1.93	0.50
1:A:129:ALA:HA	1:A:377:LEU:HD21	1.93	0.50
1:A:154:ILE:HG21	2:A:1395:CNA:N7N	2.26	0.50
1:B:304:LEU:O	1:B:306:VAL:N	2.44	0.50
1:K:271:ASP:OD1	1:K:276:ARG:NH2	2.44	0.50
1:C:306:VAL:HG11	1:D:303:LEU:CD2	2.42	0.50
1:F:307:VAL:HG12	1:L:307:VAL:HA	1.93	0.50
1:K:224:ARG:HG2	1:K:226:TYR:CE1	2.47	0.50
1:A:304:LEU:CD2	1:C:303:LEU:HD12	2.41	0.50
1:A:383:MET:O	1:A:387:VAL:HG23	2.11	0.50
1:F:156:ASP:HA	3:F:1396:SR7:HAP	1.94	0.50
1:F:162:SER:O	1:F:165:TYR:N	2.44	0.50
1:I:160:PRO:HA	1:I:165:TYR:CG	2.46	0.50
1:I:206:PRO:HG3	1:I:236:VAL:HG12	1.94	0.50
1:I:327:PHE:HA	1:I:330:LEU:HD12	1.93	0.50
1:A:307:VAL:HA	1:D:307:VAL:HG12	1.93	0.50
1:D:146:ALA:HB2	2:D:1394:CNA:H16	1.94	0.50
1:A:266:GLU:OE1	1:A:266:GLU:N	2.42	0.50
1:G:157:PHE:CD1	3:G:1396:SR7:HAP	2.47	0.50

Continued on next page...

Continued from previous page...

Atom-1	Atom-2	Interatomic distance (Å)	Clash overlap (Å)
2:H:1395:CNA:C4N	3:H:1396:SR7:HAP	2.41	0.50
1:K:149:SER:O	1:K:150:THR:C	2.50	0.50
1:C:168:LEU:HD23	1:C:194:THR:HG21	1.94	0.49
1:B:195:LEU:O	1:B:196:ALA:C	2.50	0.49
1:I:215:LEU:HD22	1:I:383:MET:HG2	1.93	0.49
1:F:278:PRO:C	1:F:279:ARG:HG2	2.32	0.49
2:I:1395:CNA:O3D	3:I:1396:SR7:CAX	2.58	0.49
1:K:227:THR:HG23	1:K:246:GLU:HA	1.95	0.49
1:C:327:PHE:O	1:C:328:ALA:C	2.49	0.49
2:C:1395:CNA:H17	2:C:1395:CNA:O2N	2.13	0.49
1:F:319:GLY:HA2	1:F:344:ASN:OD1	2.12	0.49
1:J:157:PHE:CE1	3:J:1396:SR7:NAL	2.80	0.49
1:C:123:LEU:HD22	1:C:127:ASP:CB	2.42	0.49
1:F:283:CYS:O	1:F:284:THR:HB	2.11	0.49
1:H:345:ARG:HG2	2:H:1395:CNA:N3A	2.27	0.49
1:L:341:LEU:HD12	1:L:360:VAL:O	2.12	0.49
1:H:302:PHE:CZ	1:H:326:PRO:HG2	2.48	0.49
1:L:156:ASP:HA	3:L:1397:SR7:HAP	1.93	0.49
1:D:182:LEU:O	1:D:183:PRO:C	2.51	0.49
1:G:125:LEU:HD11	1:G:373:LEU:HD13	1.94	0.49
1:H:348:VAL:O	1:H:351:LEU:HB2	2.13	0.49
1:A:304:LEU:O	1:A:306:VAL:N	2.45	0.49
1:B:234:GLU:HB3	1:B:244:LEU:HD21	1.95	0.49
1:C:133:ARG:C	1:C:135:ARG:H	2.16	0.49
1:D:195:LEU:O	1:D:195:LEU:HD23	2.12	0.49
1:A:156:ASP:OD1	1:A:158:ARG:HB2	2.12	0.49
1:D:283:CYS:O	1:D:284:THR:OG1	2.28	0.49
1:B:368:HIS:ND1	1:B:368:HIS:O	2.47	0.48
1:C:224:ARG:HG2	1:C:226:TYR:CE1	2.48	0.48
1:C:304:LEU:O	1:C:305:HIS:C	2.50	0.48
1:D:227:THR:OG1	1:D:229:ASN:HB2	2.13	0.48
1:L:122:LYS:HA	1:L:122:LYS:HE3	1.95	0.48
1:A:342:LEU:HB2	1:A:351:LEU:HD12	1.96	0.48
1:J:225:LEU:HD12	1:J:226:TYR:N	2.29	0.48
1:A:182:LEU:HB2	1:A:183:PRO:HD3	1.95	0.48
1:C:256:CYS:SG	1:C:259:CYS:N	2.86	0.48
1:B:160:PRO:HA	1:B:165:TYR:CD2	2.49	0.48
1:H:366:VAL:O	1:H:370:VAL:HG23	2.13	0.48
1:H:209:THR:HG23	1:H:370:VAL:HG21	1.95	0.48
1:J:313:ASP:C	1:J:338:VAL:HG13	2.33	0.48
1:K:166:SER:HA	1:K:169:GLN:HG2	1.94	0.48

Continued on next page...

Continued from previous page...

Atom-1	Atom-2	Interatomic distance (Å)	Clash overlap (Å)
1:A:199:LEU:HD11	3:A:1396:SR7:HAN	1.96	0.48
1:K:332:GLU:OE2	1:K:350:PRO:HB3	2.14	0.48
1:A:208:VAL:HG11	1:A:367:VAL:HG13	1.96	0.48
1:F:148:ILE:HD12	1:F:210:HIS:CE1	2.49	0.48
1:H:377:LEU:HD13	1:H:379:TRP:CH2	2.49	0.48
1:A:225:LEU:C	1:A:225:LEU:HD12	2.34	0.48
1:H:254:ALA:HA	1:H:289:PRO:HA	1.95	0.48
1:K:150:THR:HB	1:K:151:PRO:CD	2.43	0.47
1:B:304:LEU:C	1:B:306:VAL:N	2.67	0.47
1:G:344:ASN:O	1:G:345:ARG:C	2.52	0.47
1:G:381:GLU:HA	1:G:384:ARG:NH1	2.29	0.47
1:I:205:LYS:HE3	1:I:205:LYS:HA	1.97	0.47
1:J:225:LEU:HD12	1:J:225:LEU:C	2.34	0.47
2:K:1395:CNA:H24	3:K:1397:SR7:CAJ	2.45	0.47
1:L:366:VAL:HG23	2:L:1395:CNA:N1A	2.29	0.47
1:C:150:THR:HG22	1:C:151:PRO:N	2.29	0.47
1:D:341:LEU:HD12	1:D:360:VAL:O	2.14	0.47
1:I:379:TRP:O	1:I:382:GLU:N	2.48	0.47
1:A:366:VAL:O	1:A:370:VAL:HG23	2.15	0.47
1:I:292:VAL:O	3:I:1396:SR7:HBHA	2.14	0.47
1:E:259:CYS:O	1:E:260:GLN:CB	2.63	0.47
1:F:199:LEU:HD11	3:F:1396:SR7:HAN	1.96	0.47
1:G:326:PRO:O	1:G:329:SER:HB3	2.13	0.47
2:G:1395:CNA:C4N	3:G:1396:SR7:CAO	2.90	0.47
1:D:195:LEU:HD23	1:D:195:LEU:C	2.35	0.47
1:D:235:ARG:HD2	1:D:246:GLU:OE2	2.15	0.47
1:G:190:LYS:N	1:G:191:PRO:CD	2.78	0.47
1:H:192:PHE:O	1:H:195:LEU:HB3	2.15	0.47
1:I:349:GLY:O	1:I:353:TRP:HB3	2.14	0.47
1:K:250:THR:HG23	1:K:252:ALA:H	1.80	0.47
1:L:345:ARG:CB	2:L:1395:CNA:O2B	2.62	0.47
3:L:1397:SR7:NBE	3:L:1397:SR7:NAY	2.62	0.47
1:D:213:LEU:HD21	1:D:318:LEU:HD11	1.97	0.47
3:E:1396:SR7:HAJ	3:E:1396:SR7:NAY	2.30	0.47
1:L:377:LEU:HD13	1:L:379:TRP:CZ3	2.50	0.47
1:F:157:PHE:CE2	3:F:1396:SR7:NAL	2.83	0.47
1:F:303:LEU:O	1:F:306:VAL:HG23	2.14	0.47
1:G:192:PHE:O	1:G:195:LEU:HB3	2.15	0.47
1:J:300:GLN:O	1:J:302:PHE:N	2.48	0.47
1:K:322:LEU:HD23	1:K:348:VAL:O	2.15	0.47
1:I:225:LEU:HD12	1:I:225:LEU:C	2.34	0.47

Continued on next page...

Continued from previous page...

Atom-1	Atom-2	Interatomic distance (Å)	Clash overlap (Å)
1:F:283:CYS:HB2	1:F:285:GLY:H	1.79	0.46
1:G:306:VAL:HG12	1:G:307:VAL:HG13	1.96	0.46
1:B:302:PHE:O	1:B:305:HIS:HB2	2.14	0.46
1:F:182:LEU:O	1:F:183:PRO:C	2.51	0.46
1:A:351:LEU:N	1:A:351:LEU:HD23	2.31	0.46
1:E:141:VAL:HG23	1:E:312:ALA:HB2	1.96	0.46
1:K:182:LEU:O	1:K:185:PHE:N	2.49	0.46
1:E:313:ASP:OD1	1:E:313:ASP:C	2.53	0.46
1:H:126:GLN:HA	1:H:376:LEU:HD22	1.97	0.46
1:H:366:VAL:HG23	2:H:1395:CNA:C6A	2.45	0.46
1:J:123:LEU:HB2	1:J:360:VAL:CG2	2.45	0.46
1:A:302:PHE:CZ	1:A:326:PRO:HG2	2.49	0.46
1:F:309:PHE:CE2	1:F:330:LEU:HD22	2.50	0.46
1:D:342:LEU:HB2	1:D:351:LEU:CD1	2.46	0.46
1:H:233:LEU:N	1:H:233:LEU:CD2	2.78	0.46
1:K:339:PRO:HA	1:K:358:ARG:O	2.16	0.46
1:A:268:ILE:HG21	1:A:287:VAL:HG11	1.98	0.46
1:B:205:LYS:CE	1:B:394:LEU:HD22	2.45	0.46
2:F:1395:CNA:O3D	3:F:1396:SR7:NAY	2.47	0.46
1:I:215:LEU:HD23	1:I:379:TRP:CE3	2.51	0.46
1:K:254:ALA:HA	1:K:289:PRO:HA	1.97	0.46
2:H:1395:CNA:H23	3:H:1396:SR7:CAX	2.29	0.46
1:K:134:ALA:O	1:K:136:ALA:N	2.49	0.46
1:K:147:GLY:HA3	1:K:319:GLY:HA3	1.97	0.46
1:B:258:VAL:O	1:B:260:GLN:HG2	2.16	0.46
1:F:142:VAL:CG1	1:F:225:LEU:HD13	2.46	0.46
1:F:328:ALA:O	1:F:331:THR:OG1	2.34	0.46
1:L:133:ARG:O	1:L:135:ARG:N	2.48	0.46
1:H:157:PHE:HB2	3:H:1396:SR7:NAI	2.32	0.45
1:K:228:GLN:O	2:K:1395:CNA:H22	2.16	0.45
1:A:193:PHE:CE2	1:A:277:VAL:HG13	2.51	0.45
1:L:125:LEU:CD1	1:L:373:LEU:HD13	2.46	0.45
1:A:298:LEU:O	1:A:299:PRO:C	2.52	0.45
1:D:150:THR:CG2	1:D:151:PRO:N	2.79	0.45
1:F:283:CYS:O	1:F:284:THR:CB	2.64	0.45
1:I:253:SER:OG	1:I:290:ASP:OD2	2.33	0.45
1:K:128:VAL:O	1:K:132:ILE:HG12	2.16	0.45
1:L:307:VAL:O	1:L:311:MET:HB2	2.17	0.45
1:A:379:TRP:CD1	1:A:379:TRP:N	2.80	0.45
1:B:256:CYS:SG	1:B:259:CYS:N	2.89	0.45
1:D:123:LEU:HD22	1:D:127:ASP:CB	2.46	0.45

Continued on next page...

Continued from previous page...

Atom-1	Atom-2	Interatomic distance (Å)	Clash overlap (Å)
1:G:157:PHE:HD1	3:G:1396:SR7:HAP	1.82	0.45
1:C:207:ASN:O	1:C:210:HIS:N	2.50	0.45
1:I:379:TRP:O	1:I:380:THR:C	2.54	0.45
1:J:162:SER:O	1:J:165:TYR:HB3	2.16	0.45
1:L:135:ARG:HB3	1:L:135:ARG:HH11	1.81	0.45
1:E:182:LEU:HD23	1:E:293:PHE:CD2	2.52	0.45
1:F:342:LEU:HD23	1:F:347:LEU:HD12	1.97	0.45
2:I:1395:CNA:C5N	3:I:1396:SR7:CAP	2.95	0.45
1:K:176:PRO:O	1:K:179:ILE:HG22	2.16	0.45
1:L:167:ASN:HB3	1:L:194:THR:HG21	1.98	0.45
1:A:188:ASN:OD1	1:A:188:ASN:C	2.55	0.45
1:A:259:CYS:HB3	1:A:283:CYS:HB3	1.69	0.45
1:E:141:VAL:CG2	1:E:312:ALA:HB2	2.47	0.45
1:I:169:GLN:O	1:I:171:TYR:N	2.50	0.45
1:A:261:ARG:NH2	1:A:282:VAL:HG11	2.32	0.45
1:C:206:PRO:HB2	1:C:211:TYR:CE2	2.52	0.45
1:A:302:PHE:O	1:A:305:HIS:CB	2.65	0.45
1:D:224:ARG:NE	1:D:308:ASP:OD2	2.43	0.45
1:L:314:LEU:HD13	1:L:339:PRO:HG2	1.99	0.45
1:B:195:LEU:O	1:B:195:LEU:HD23	2.17	0.44
1:B:343:ILE:HG12	1:B:362:GLN:HB3	1.99	0.44
1:L:148:ILE:O	1:L:151:PRO:HD2	2.17	0.44
1:L:155:PRO:O	3:L:1397:SR7:HAM	2.16	0.44
1:D:224:ARG:HG2	1:D:226:TYR:CE1	2.51	0.44
1:D:235:ARG:HH11	1:D:235:ARG:HG2	1.82	0.44
1:C:316:LEU:HD13	1:C:341:LEU:HD23	1.99	0.44
1:F:301:ARG:HA	5:K:1396:GOL:H2	1.99	0.44
1:A:160:PRO:HA	1:A:165:TYR:CD2	2.53	0.44
1:B:342:LEU:HD11	1:B:344:ASN:HB2	1.99	0.44
1:H:331:THR:O	1:H:340:ARG:NH1	2.45	0.44
1:E:383:MET:O	1:E:387:VAL:HG13	2.17	0.44
1:L:316:LEU:CD1	1:L:341:LEU:HD23	2.47	0.44
1:E:173:LEU:O	1:E:174:PRO:C	2.56	0.44
1:I:129:ALA:HB2	1:I:373:LEU:HD12	2.00	0.44
1:I:129:ALA:HB2	1:I:373:LEU:CD1	2.47	0.44
1:K:122:LYS:HA	1:K:122:LYS:CE	2.46	0.44
1:K:379:TRP:O	1:K:383:MET:N	2.44	0.44
1:L:190:LYS:N	1:L:191:PRO:HD2	2.32	0.44
1:B:216:LEU:HD12	1:B:216:LEU:HA	1.87	0.44
1:C:231:ASP:O	1:C:233:LEU:HG	2.18	0.44
1:C:298:LEU:HB3	1:C:299:PRO:HD2	2.00	0.44

Continued on next page...

Continued from previous page...

Atom-1	Atom-2	Interatomic distance (Å)	Clash overlap (Å)
1:K:182:LEU:CB	1:K:183:PRO:CD	2.96	0.44
1:L:261:ARG:CZ	1:L:282:VAL:HG21	2.48	0.44
1:C:123:LEU:HB3	1:C:360:VAL:CG2	2.48	0.44
1:D:232:GLY:O	1:D:236:VAL:HG23	2.17	0.44
1:E:234:GLU:HB2	1:E:244:LEU:HD21	1.99	0.44
1:E:269:ARG:O	1:E:273:MET:HG2	2.18	0.44
1:J:205:LYS:HE2	1:J:394:LEU:HD22	2.00	0.44
1:B:301:ARG:HA	5:D:1395:GOL:H2	1.99	0.43
1:A:344:ASN:O	1:A:363:LEU:HA	2.18	0.43
1:B:302:PHE:O	1:B:305:HIS:CB	2.66	0.43
1:G:248:HIS:CE1	3:G:1396:SR7:CAR	3.01	0.43
1:H:374:VAL:HG13	1:H:379:TRP:HB2	2.00	0.43
1:J:156:ASP:HA	3:J:1396:SR7:CAP	2.46	0.43
1:L:274:ALA:HB3	1:L:276:ARG:NH1	2.33	0.43
1:B:169:GLN:O	1:B:170:GLN:C	2.57	0.43
1:D:304:LEU:CD1	1:D:304:LEU:N	2.81	0.43
1:C:304:LEU:C	1:C:306:VAL:N	2.72	0.43
1:D:374:VAL:HG11	1:D:383:MET:HG3	2.01	0.43
1:E:327:PHE:O	1:E:328:ALA:C	2.57	0.43
1:F:236:VAL:C	1:F:238:GLY:N	2.72	0.43
1:C:135:ARG:HD2	1:C:135:ARG:HA	1.75	0.43
1:H:149:SER:HB3	1:H:154:ILE:HD12	2.01	0.43
1:F:155:PRO:O	3:F:1396:SR7:HAM	2.18	0.43
1:F:235:ARG:NH2	1:F:246:GLU:OE1	2.52	0.43
1:G:144:VAL:HG12	1:G:318:LEU:HB2	1.99	0.43
2:G:1395:CNA:C5N	3:G:1396:SR7:NAI	2.76	0.43
1:K:149:SER:O	1:K:152:SER:N	2.42	0.43
1:K:292:VAL:O	3:K:1397:SR7:HBC	2.19	0.43
1:B:269:ARG:O	1:B:270:ALA:C	2.57	0.43
1:C:347:LEU:HD23	1:C:352:ALA:HA	2.01	0.43
1:D:144:VAL:HG21	1:D:148:ILE:CD1	2.49	0.43
1:D:228:GLN:HG3	1:D:327:PHE:CZ	2.53	0.43
1:F:226:TYR:CE2	1:F:245:VAL:HG21	2.53	0.43
1:H:173:LEU:HA	1:H:174:PRO:HD2	1.92	0.43
1:H:256:CYS:SG	1:H:259:CYS:N	2.91	0.43
1:H:328:ALA:O	1:H:331:THR:OG1	2.37	0.43
1:I:155:PRO:O	3:I:1396:SR7:HAM	2.19	0.43
1:K:307:VAL:O	1:K:311:MET:HB2	2.18	0.43
1:E:299:PRO:O	1:E:300:GLN:C	2.57	0.43
1:E:339:PRO:HA	1:E:358:ARG:O	2.19	0.43
1:E:344:ASN:O	1:E:345:ARG:C	2.57	0.43

Continued on next page...

Continued from previous page...

Atom-1	Atom-2	Interatomic distance (Å)	Clash overlap (Å)
1:F:157:PHE:CE2	1:F:179:ILE:HD11	2.53	0.43
2:K:1395:CNA:H18	2:K:1395:CNA:H30	1.79	0.43
1:L:125:LEU:HD11	1:L:373:LEU:HD13	2.00	0.43
1:B:256:CYS:HA	1:B:287:VAL:HA	2.00	0.42
1:C:182:LEU:HD23	1:C:182:LEU:HA	1.92	0.42
1:D:185:PHE:O	1:D:189:PRO:HD3	2.19	0.42
1:G:345:ARG:HD3	1:G:345:ARG:HA	1.88	0.42
1:I:248:HIS:O	1:I:292:VAL:HG23	2.18	0.42
3:K:1397:SR7:NAY	3:K:1397:SR7:HAJ	2.34	0.42
1:A:150:THR:HB	1:A:151:PRO:CD	2.49	0.42
1:A:342:LEU:HD22	1:A:351:LEU:HD12	2.00	0.42
1:B:269:ARG:HG2	1:B:270:ALA:N	2.33	0.42
1:C:344:ASN:HD22	1:C:346:ASP:H	1.66	0.42
1:C:368:HIS:O	1:C:368:HIS:CD2	2.72	0.42
1:J:214:ARG:HG3	1:J:386:LEU:HD21	2.01	0.42
1:A:204:TYR:O	1:A:233:LEU:HD21	2.18	0.42
1:A:368:HIS:O	1:A:368:HIS:CG	2.72	0.42
1:C:182:LEU:O	1:C:183:PRO:C	2.58	0.42
1:C:318:LEU:HD23	1:C:318:LEU:N	2.34	0.42
1:D:379:TRP:O	1:D:381:GLU:N	2.52	0.42
1:H:386:LEU:O	1:H:387:VAL:C	2.58	0.42
1:A:258:VAL:O	1:A:260:GLN:HG2	2.19	0.42
1:B:235:ARG:HG2	1:B:235:ARG:HH11	1.85	0.42
1:B:235:ARG:HG2	1:B:235:ARG:NH1	2.34	0.42
1:F:303:LEU:O	1:F:303:LEU:HD12	2.19	0.42
1:G:123:LEU:N	1:G:123:LEU:HD23	2.34	0.42
1:H:321:SER:O	1:H:322:LEU:HB2	2.20	0.42
1:K:304:LEU:O	1:K:305:HIS:C	2.56	0.42
1:B:301:ARG:CG	5:D:1395:GOL:H2	2.47	0.42
1:G:158:ARG:NH1	3:G:1396:SR7:CBF	2.82	0.42
1:K:190:LYS:N	1:K:191:PRO:HD2	2.33	0.42
1:L:361:ALA:HB1	1:L:363:LEU:HG	2.01	0.42
1:A:227:THR:OG1	1:A:229:ASN:HB2	2.19	0.42
1:A:303:LEU:HD13	1:B:306:VAL:CG1	2.49	0.42
1:E:199:LEU:HD11	3:E:1396:SR7:HAN	2.02	0.42
2:E:1395:CNA:H17	2:E:1395:CNA:O2N	2.20	0.42
1:H:354:HIS:N	1:H:355:PRO:CD	2.82	0.42
1:L:260:GLN:O	1:L:261:ARG:C	2.57	0.42
1:B:303:LEU:HD23	1:D:304:LEU:CD1	2.47	0.42
1:B:374:VAL:HG11	1:B:383:MET:HG3	2.02	0.42
1:E:190:LYS:N	1:E:191:PRO:CD	2.83	0.42

Continued on next page...

Continued from previous page...

Atom-1	Atom-2	Interatomic distance (Å)	Clash overlap (Å)
1:G:150:THR:HB	1:G:151:PRO:HD3	2.01	0.42
1:B:140:VAL:HG13	1:B:221:LEU:O	2.20	0.42
1:E:190:LYS:N	1:E:191:PRO:HD2	2.35	0.42
1:I:222:LEU:O	1:I:243:LYS:NZ	2.50	0.42
1:A:146:ALA:HB2	2:A:1395:CNA:H16	2.01	0.42
1:B:248:HIS:O	1:B:292:VAL:HG23	2.19	0.42
3:C:1397:SR7:NAY	3:C:1397:SR7:HAJ	2.34	0.42
1:D:195:LEU:C	1:D:195:LEU:CD2	2.88	0.42
1:D:361:ALA:HB1	1:D:363:LEU:HD21	2.02	0.42
1:F:141:VAL:CG2	1:F:312:ALA:HB2	2.49	0.42
1:F:157:PHE:CE2	3:F:1396:SR7:CAG	3.03	0.42
1:F:160:PRO:HA	1:F:165:TYR:CG	2.55	0.42
1:H:383:MET:O	1:H:387:VAL:HG13	2.20	0.42
1:J:294:PHE:CD1	3:J:1396:SR7:HAU	2.54	0.42
1:B:344:ASN:O	1:B:345:ARG:C	2.58	0.42
1:J:271:ASP:OD1	1:J:271:ASP:N	2.53	0.42
2:A:1395:CNA:H24	3:A:1396:SR7:CAJ	2.50	0.41
1:B:333:ALA:O	1:B:334:VAL:C	2.58	0.41
1:D:364:GLY:O	2:D:1394:CNA:H13	2.20	0.41
1:H:228:GLN:HG3	1:H:327:PHE:CE1	2.54	0.41
1:I:205:LYS:HD2	1:I:205:LYS:N	2.34	0.41
1:K:361:ALA:HB1	1:K:363:LEU:HG	2.02	0.41
1:A:175:TYR:O	1:A:176:PRO:C	2.56	0.41
1:A:184:PHE:O	1:A:185:PHE:C	2.58	0.41
1:E:133:ARG:C	1:E:135:ARG:N	2.71	0.41
1:F:157:PHE:H	3:F:1396:SR7:HAP	1.85	0.41
2:F:1395:CNA:H24	3:F:1396:SR7:CAJ	2.50	0.41
1:H:346:ASP:HA	1:H:363:LEU:HD22	2.02	0.41
1:A:233:LEU:HA	1:A:236:VAL:CG1	2.47	0.41
1:A:234:GLU:HB3	1:A:244:LEU:HD21	2.01	0.41
1:B:127:ASP:O	1:B:130:GLU:HB2	2.20	0.41
1:B:302:PHE:O	1:B:302:PHE:CD2	2.74	0.41
1:C:157:PHE:CE2	3:C:1397:SR7:CAG	3.03	0.41
1:F:149:SER:HB3	1:F:154:ILE:HD13	2.02	0.41
1:F:342:LEU:HD11	1:F:344:ASN:HB2	2.01	0.41
1:G:261:ARG:HG2	1:G:263:PHE:CE1	2.56	0.41
1:I:375:GLU:HA	1:I:380:THR:HG23	2.02	0.41
1:K:199:LEU:HD11	3:K:1397:SR7:HAN	2.02	0.41
1:C:259:CYS:O	1:C:260:GLN:HB2	2.20	0.41
1:D:190:LYS:N	1:D:191:PRO:CD	2.84	0.41
1:H:225:LEU:C	1:H:225:LEU:HD12	2.40	0.41

Continued on next page...

Continued from previous page...

Atom-1	Atom-2	Interatomic distance (Å)	Clash overlap (Å)
1:K:256:CYS:SG	1:K:258:VAL:HG13	2.61	0.41
1:L:195:LEU:HD21	1:L:199:LEU:HD12	2.02	0.41
1:B:345:ARG:HG2	2:B:1395:CNA:N3A	2.35	0.41
1:H:234:GLU:O	1:H:237:SER:OG	2.30	0.41
2:B:1395:CNA:H19	3:B:1396:SR7:NBE	2.36	0.41
1:C:292:VAL:HG21	1:C:299:PRO:HD3	2.03	0.41
1:E:305:HIS:O	1:E:307:VAL:N	2.54	0.41
1:F:370:VAL:O	1:F:373:LEU:N	2.53	0.41
1:H:209:THR:HG21	1:H:366:VAL:HG11	2.02	0.41
1:I:242:SER:O	1:I:301:ARG:NH2	2.54	0.41
1:B:345:ARG:HH11	1:B:345:ARG:CB	2.32	0.41
1:C:341:LEU:HD12	1:C:360:VAL:O	2.20	0.41
1:E:223:LEU:O	1:E:223:LEU:HD12	2.21	0.41
1:F:176:PRO:HG2	1:F:177:GLU:OE2	2.21	0.41
1:G:337:SER:O	1:G:358:ARG:NH1	2.53	0.41
1:H:285:GLY:O	1:H:286:VAL:C	2.58	0.41
1:L:316:LEU:HD11	1:L:341:LEU:HD23	2.03	0.41
1:A:311:MET:HG2	1:D:311:MET:HG3	2.03	0.41
1:D:133:ARG:C	1:D:135:ARG:N	2.75	0.41
1:D:149:SER:O	1:D:154:ILE:HB	2.21	0.41
1:F:321:SER:N	2:F:1395:CNA:O2N	2.40	0.41
1:J:300:GLN:C	1:J:302:PHE:N	2.73	0.41
1:K:193:PHE:CZ	1:K:278:PRO:HD2	2.55	0.41
1:K:377:LEU:HD23	1:K:379:TRP:CH2	2.56	0.41
1:A:165:TYR:O	1:A:169:GLN:HG2	2.21	0.41
1:A:195:LEU:HD12	1:A:199:LEU:HG	2.03	0.41
1:A:266:GLU:H	1:A:266:GLU:CD	2.21	0.41
1:B:175:TYR:CD1	1:B:175:TYR:N	2.89	0.41
1:B:195:LEU:C	1:B:195:LEU:CD2	2.89	0.41
1:B:198:GLU:O	1:B:203:ASN:ND2	2.54	0.41
1:B:298:LEU:O	1:B:299:PRO:C	2.58	0.41
1:B:351:LEU:HD23	1:B:351:LEU:N	2.35	0.41
1:D:327:PHE:O	1:D:328:ALA:C	2.58	0.41
1:E:248:HIS:CE1	3:E:1396:SR7:HAR	2.56	0.41
1:H:261:ARG:HE	1:H:261:ARG:HB2	1.50	0.41
1:L:304:LEU:O	1:L:305:HIS:C	2.60	0.41
1:B:150:THR:HB	1:B:151:PRO:HD3	2.03	0.41
1:B:266:GLU:CD	1:B:266:GLU:H	2.24	0.41
1:B:302:PHE:O	1:B:302:PHE:CG	2.74	0.41
1:C:137:CYS:HA	1:C:313:ASP:OD2	2.21	0.41
1:D:125:LEU:O	1:D:126:GLN:C	2.58	0.41

Continued on next page...

Continued from previous page...

Atom-1	Atom-2	Interatomic distance (Å)	Clash overlap (Å)
3:D:1396:SR7:NBE	3:D:1396:SR7:NAY	2.67	0.41
1:F:150:THR:HB	1:F:151:PRO:CD	2.51	0.41
1:H:302:PHE:C	1:H:304:LEU:H	2.24	0.41
1:K:182:LEU:HB2	1:K:183:PRO:CD	2.51	0.41
1:B:384:ARG:HB3	1:B:384:ARG:HH11	1.86	0.40
1:H:318:LEU:CD1	1:H:343:ILE:HB	2.47	0.40
1:L:227:THR:OG1	1:L:229:ASN:HB2	2.22	0.40
1:C:228:GLN:HG3	1:C:327:PHE:CZ	2.56	0.40
1:E:171:TYR:O	1:E:172:ASP:C	2.59	0.40
1:G:383:MET:O	1:G:384:ARG:C	2.59	0.40
1:I:150:THR:HB	1:I:151:PRO:CD	2.51	0.40
1:J:154:ILE:HA	1:J:155:PRO:HD3	1.93	0.40
1:J:248:HIS:NE2	3:J:1396:SR7:HAR	2.36	0.40
1:J:277:VAL:O	1:J:277:VAL:HG12	2.21	0.40
1:K:145:GLY:O	1:K:146:ALA:C	2.60	0.40
1:A:148:ILE:HD12	1:A:210:HIS:CD2	2.57	0.40
1:A:212:PHE:O	1:A:213:LEU:C	2.59	0.40
1:B:298:LEU:HB3	1:B:299:PRO:HD2	2.02	0.40
2:B:1395:CNA:H19	3:B:1396:SR7:HNBE	1.86	0.40
1:D:134:ALA:O	1:D:135:ARG:HB2	2.22	0.40
1:F:162:SER:O	1:F:165:TYR:HB3	2.21	0.40
1:G:182:LEU:HD23	1:G:293:PHE:CD2	2.55	0.40
1:G:195:LEU:O	1:G:196:ALA:C	2.60	0.40
1:G:264:PRO:HD2	1:G:267:ASP:CG	2.42	0.40
1:H:195:LEU:HD11	3:H:1396:SR7:HAO	2.01	0.40
1:I:173:LEU:HD23	1:I:173:LEU:HA	1.96	0.40
1:J:160:PRO:HA	1:J:165:TYR:CD1	2.56	0.40
1:J:188:ASN:O	1:J:191:PRO:HD2	2.21	0.40
1:K:304:LEU:O	1:K:307:VAL:N	2.53	0.40
1:L:164:LEU:HD11	1:L:195:LEU:HA	2.03	0.40
1:B:195:LEU:HD23	1:B:195:LEU:C	2.42	0.40
1:D:146:ALA:HB2	2:D:1394:CNA:C5D	2.51	0.40
1:E:132:ILE:HG23	1:E:221:LEU:HD13	2.03	0.40
1:G:225:LEU:HD22	1:G:244:LEU:CD2	2.52	0.40
2:G:1395:CNA:H30	3:G:1396:SR7:CAJ	2.52	0.40
1:I:179:ILE:HG23	1:I:180:PHE:CD2	2.56	0.40
1:J:374:VAL:HG11	1:J:383:MET:HG3	2.03	0.40
1:K:304:LEU:O	1:K:306:VAL:N	2.54	0.40
1:L:320:THR:O	1:L:320:THR:HG23	2.20	0.40
3:L:1397:SR7:NAY	3:L:1397:SR7:HAJ	2.37	0.40
1:A:160:PRO:HA	1:A:165:TYR:CG	2.57	0.40

Continued on next page...

Continued from previous page...

Atom-1	Atom-2	Interatomic distance (Å)	Clash overlap (Å)
1:A:163:GLY:O	1:A:167:ASN:ND2	2.54	0.40
1:C:365:ASP:O	1:C:366:VAL:C	2.58	0.40
1:E:171:TYR:CD2	1:E:191:PRO:HB3	2.56	0.40
1:E:215:LEU:HD11	1:E:219:LYS:HE2	2.03	0.40
1:G:209:THR:HG23	1:G:370:VAL:HG21	2.03	0.40
1:H:191:PRO:O	1:H:192:PHE:C	2.59	0.40
1:K:139:ARG:O	1:K:313:ASP:OD1	2.39	0.40
1:K:150:THR:HB	1:K:151:PRO:HD3	2.03	0.40
1:K:312:ALA:O	1:K:338:VAL:HG21	2.21	0.40

All (1) symmetry-related close contacts are listed below. The label for Atom-2 includes the symmetry operator and encoded unit-cell translations to be applied.

Atom-1	Atom-2	Interatomic distance (Å)	Clash overlap (Å)
1:E:305:HIS:NE2	1:E:305:HIS:NE2[2_756]	1.96	0.24

5.3 Torsion angles [i](#)

5.3.1 Protein backbone [i](#)

In the following table, the Percentiles column shows the percent Ramachandran outliers of the chain as a percentile score with respect to all X-ray entries followed by that with respect to entries of similar resolution.

The Analysed column shows the number of residues for which the backbone conformation was analysed, and the total number of residues.

Mol	Chain	Analysed	Favoured	Allowed	Outliers	Percentiles	
1	A	271/281 (96%)	230 (85%)	37 (14%)	4 (2%)	10	39
1	B	271/281 (96%)	231 (85%)	35 (13%)	5 (2%)	8	35
1	C	271/281 (96%)	223 (82%)	36 (13%)	12 (4%)	2	15
1	D	270/281 (96%)	227 (84%)	33 (12%)	10 (4%)	3	19
1	E	271/281 (96%)	241 (89%)	23 (8%)	7 (3%)	5	27
1	F	271/281 (96%)	239 (88%)	29 (11%)	3 (1%)	14	46
1	G	271/281 (96%)	249 (92%)	18 (7%)	4 (2%)	10	39
1	H	271/281 (96%)	244 (90%)	24 (9%)	3 (1%)	14	46
1	I	271/281 (96%)	237 (88%)	29 (11%)	5 (2%)	8	35

Continued on next page...

Continued from previous page...

Mol	Chain	Analysed	Favoured	Allowed	Outliers	Percentiles	
1	J	271/281 (96%)	246 (91%)	21 (8%)	4 (2%)	10	39
1	K	271/281 (96%)	237 (88%)	26 (10%)	8 (3%)	4	24
1	L	271/281 (96%)	237 (88%)	29 (11%)	5 (2%)	8	35
All	All	3251/3372 (96%)	2841 (87%)	340 (10%)	70 (2%)	6	31

All (70) Ramachandran outliers are listed below:

Mol	Chain	Res	Type
1	A	305	HIS
1	B	305	HIS
1	C	176	PRO
1	C	242	SER
1	C	305	HIS
1	C	381	GLU
1	D	305	HIS
1	E	172	ASP
1	E	260	GLN
1	E	306	VAL
1	J	328	ALA
1	K	135	ARG
1	K	305	HIS
1	L	135	ARG
1	L	305	HIS
1	A	282	VAL
1	B	257	THR
1	C	132	ILE
1	C	258	VAL
1	D	354	HIS
1	D	380	THR
1	E	134	ALA
1	E	258	VAL
1	F	172	ASP
1	G	306	VAL
1	H	258	VAL
1	I	170	GLN
1	I	380	THR
1	J	208	VAL
1	J	301	ARG
1	K	150	THR
1	K	258	VAL
1	K	322	LEU

Continued on next page...

Continued from previous page...

Mol	Chain	Res	Type
1	L	345	ARG
1	B	259	CYS
1	B	336	SER
1	F	284	THR
1	K	300	GLN
1	C	131	LEU
1	C	134	ALA
1	C	349	GLY
1	C	355	PRO
1	D	270	ALA
1	E	177	GLU
1	E	350	PRO
1	I	126	GLN
1	I	176	PRO
1	L	300	GLN
1	A	354	HIS
1	B	201	PRO
1	C	174	PRO
1	D	151	PRO
1	D	206	PRO
1	D	232	GLY
1	G	126	GLN
1	G	241	ALA
1	H	164	LEU
1	H	303	LEU
1	K	134	ALA
1	L	353	TRP
1	D	134	ALA
1	D	150	THR
1	G	258	VAL
1	F	208	VAL
1	C	268	ILE
1	D	370	VAL
1	I	258	VAL
1	J	201	PRO
1	K	147	GLY
1	A	258	VAL

5.3.2 Protein sidechains [i](#)

In the following table, the Percentiles column shows the percent sidechain outliers of the chain as a percentile score with respect to all X-ray entries followed by that with respect to entries of similar

resolution.

The Analysed column shows the number of residues for which the sidechain conformation was analysed, and the total number of residues.

Mol	Chain	Analysed	Rotameric	Outliers	Percentiles	
1	A	237/243 (98%)	210 (89%)	27 (11%)	5	22
1	B	237/243 (98%)	201 (85%)	36 (15%)	3	12
1	C	234/243 (96%)	201 (86%)	33 (14%)	3	15
1	D	219/243 (90%)	197 (90%)	22 (10%)	7	27
1	E	227/243 (93%)	204 (90%)	23 (10%)	7	27
1	F	237/243 (98%)	210 (89%)	27 (11%)	5	22
1	G	237/243 (98%)	213 (90%)	24 (10%)	7	27
1	H	237/243 (98%)	213 (90%)	24 (10%)	7	27
1	I	232/243 (96%)	205 (88%)	27 (12%)	5	22
1	J	237/243 (98%)	211 (89%)	26 (11%)	6	24
1	K	237/243 (98%)	213 (90%)	24 (10%)	7	27
1	L	235/243 (97%)	212 (90%)	23 (10%)	8	29
All	All	2806/2916 (96%)	2490 (89%)	316 (11%)	6	22

All (316) residues with a non-rotameric sidechain are listed below:

Mol	Chain	Res	Type
1	A	122	LYS
1	A	139	ARG
1	A	154	ILE
1	A	170	GLN
1	A	173	LEU
1	A	200	TYR
1	A	203	ASN
1	A	205	LYS
1	A	225	LEU
1	A	243	LYS
1	A	256	CYS
1	A	266	GLU
1	A	279	ARG
1	A	289	PRO
1	A	305	HIS
1	A	307	VAL
1	A	311	MET
1	A	318	LEU

Continued on next page...

Continued from previous page...

Mol	Chain	Res	Type
1	A	323	GLU
1	A	329	SER
1	A	336	SER
1	A	341	LEU
1	A	345	ARG
1	A	347	LEU
1	A	353	TRP
1	A	354	HIS
1	A	385	ASP
1	B	122	LYS
1	B	135	ARG
1	B	138	GLN
1	B	139	ARG
1	B	140	VAL
1	B	156	ASP
1	B	170	GLN
1	B	172	ASP
1	B	173	LEU
1	B	175	TYR
1	B	190	LYS
1	B	200	TYR
1	B	203	ASN
1	B	205	LYS
1	B	208	VAL
1	B	230	ILE
1	B	231	ASP
1	B	235	ARG
1	B	253	SER
1	B	256	CYS
1	B	258	VAL
1	B	269	ARG
1	B	279	ARG
1	B	282	VAL
1	B	283	CYS
1	B	303	LEU
1	B	305	HIS
1	B	306	VAL
1	B	318	LEU
1	B	345	ARG
1	B	351	LEU
1	B	360	VAL
1	B	366	VAL

Continued on next page...

Continued from previous page...

Mol	Chain	Res	Type
1	B	372	SER
1	B	375	GLU
1	B	380	THR
1	C	135	ARG
1	C	138	GLN
1	C	139	ARG
1	C	150	THR
1	C	152	SER
1	C	172	ASP
1	C	179	ILE
1	C	190	LYS
1	C	200	TYR
1	C	208	VAL
1	C	209	THR
1	C	227	THR
1	C	230	ILE
1	C	231	ASP
1	C	242	SER
1	C	250	THR
1	C	256	CYS
1	C	257	THR
1	C	259	CYS
1	C	280	CYS
1	C	283	CYS
1	C	303	LEU
1	C	305	HIS
1	C	306	VAL
1	C	307	VAL
1	C	329	SER
1	C	336	SER
1	C	347	LEU
1	C	354	HIS
1	C	356	ARG
1	C	376	LEU
1	C	380	THR
1	C	384	ARG
1	D	123	LEU
1	D	133	ARG
1	D	135	ARG
1	D	139	ARG
1	D	150	THR
1	D	175	TYR

Continued on next page...

Continued from previous page...

Mol	Chain	Res	Type
1	D	179	ILE
1	D	190	LYS
1	D	200	TYR
1	D	208	VAL
1	D	256	CYS
1	D	259	CYS
1	D	271	ASP
1	D	283	CYS
1	D	304	LEU
1	D	318	LEU
1	D	329	SER
1	D	336	SER
1	D	346	ASP
1	D	347	LEU
1	D	375	GLU
1	D	376	LEU
1	E	122	LYS
1	E	125	LEU
1	E	127	ASP
1	E	139	ARG
1	E	150	THR
1	E	173	LEU
1	E	190	LYS
1	E	200	TYR
1	E	203	ASN
1	E	208	VAL
1	E	209	THR
1	E	216	LEU
1	E	250	THR
1	E	284	THR
1	E	304	LEU
1	E	311	MET
1	E	313	ASP
1	E	318	LEU
1	E	327	PHE
1	E	351	LEU
1	E	353	TRP
1	E	366	VAL
1	E	376	LEU
1	F	122	LYS
1	F	135	ARG
1	F	162	SER

Continued on next page...

Continued from previous page...

Mol	Chain	Res	Type
1	F	166	SER
1	F	172	ASP
1	F	182	LEU
1	F	194	THR
1	F	200	TYR
1	F	203	ASN
1	F	205	LYS
1	F	216	LEU
1	F	250	THR
1	F	256	CYS
1	F	258	VAL
1	F	266	GLU
1	F	271	ASP
1	F	280	CYS
1	F	283	CYS
1	F	284	THR
1	F	303	LEU
1	F	306	VAL
1	F	316	LEU
1	F	318	LEU
1	F	331	THR
1	F	345	ARG
1	F	353	TRP
1	F	366	VAL
1	G	122	LYS
1	G	173	LEU
1	G	177	GLU
1	G	190	LYS
1	G	200	TYR
1	G	205	LYS
1	G	253	SER
1	G	256	CYS
1	G	258	VAL
1	G	259	CYS
1	G	269	ARG
1	G	271	ASP
1	G	280	CYS
1	G	283	CYS
1	G	304	LEU
1	G	311	MET
1	G	318	LEU
1	G	320	THR

Continued on next page...

Continued from previous page...

Mol	Chain	Res	Type
1	G	321	SER
1	G	327	PHE
1	G	345	ARG
1	G	353	TRP
1	G	358	ARG
1	G	366	VAL
1	H	122	LYS
1	H	150	THR
1	H	152	SER
1	H	156	ASP
1	H	173	LEU
1	H	194	THR
1	H	200	TYR
1	H	216	LEU
1	H	225	LEU
1	H	233	LEU
1	H	235	ARG
1	H	240	PRO
1	H	256	CYS
1	H	261	ARG
1	H	283	CYS
1	H	311	MET
1	H	318	LEU
1	H	320	THR
1	H	329	SER
1	H	336	SER
1	H	345	ARG
1	H	353	TRP
1	H	376	LEU
1	H	381	GLU
1	I	122	LYS
1	I	123	LEU
1	I	126	GLN
1	I	139	ARG
1	I	166	SER
1	I	171	TYR
1	I	184	PHE
1	I	194	THR
1	I	195	LEU
1	I	200	TYR
1	I	225	LEU
1	I	235	ARG

Continued on next page...

Continued from previous page...

Mol	Chain	Res	Type
1	I	253	SER
1	I	256	CYS
1	I	258	VAL
1	I	279	ARG
1	I	280	CYS
1	I	283	CYS
1	I	311	MET
1	I	320	THR
1	I	327	PHE
1	I	346	ASP
1	I	353	TRP
1	I	366	VAL
1	I	380	THR
1	I	385	ASP
1	I	386	LEU
1	J	122	LYS
1	J	124	SER
1	J	139	ARG
1	J	159	SER
1	J	170	GLN
1	J	172	ASP
1	J	179	ILE
1	J	182	LEU
1	J	195	LEU
1	J	200	TYR
1	J	215	LEU
1	J	216	LEU
1	J	223	LEU
1	J	225	LEU
1	J	250	THR
1	J	266	GLU
1	J	271	ASP
1	J	279	ARG
1	J	303	LEU
1	J	305	HIS
1	J	318	LEU
1	J	320	THR
1	J	345	ARG
1	J	353	TRP
1	J	366	VAL
1	J	380	THR
1	K	122	LYS

Continued on next page...

Continued from previous page...

Mol	Chain	Res	Type
1	K	162	SER
1	K	173	LEU
1	K	175	TYR
1	K	177	GLU
1	K	187	HIS
1	K	194	THR
1	K	200	TYR
1	K	227	THR
1	K	230	ILE
1	K	235	ARG
1	K	250	THR
1	K	258	VAL
1	K	266	GLU
1	K	278	PRO
1	K	305	HIS
1	K	306	VAL
1	K	322	LEU
1	K	329	SER
1	K	336	SER
1	K	344	ASN
1	K	348	VAL
1	K	351	LEU
1	K	387	VAL
1	L	122	LYS
1	L	135	ARG
1	L	138	GLN
1	L	139	ARG
1	L	154	ILE
1	L	158	ARG
1	L	162	SER
1	L	175	TYR
1	L	200	TYR
1	L	216	LEU
1	L	225	LEU
1	L	235	ARG
1	L	258	VAL
1	L	266	GLU
1	L	269	ARG
1	L	306	VAL
1	L	347	LEU
1	L	348	VAL
1	L	380	THR

Continued on next page...

Continued from previous page...

Mol	Chain	Res	Type
1	L	387	VAL
1	L	388	GLN
1	L	389	ARG
1	L	393	LYS

Sometimes sidechains can be flipped to improve hydrogen bonding and reduce clashes. All (23) such sidechains are listed below:

Mol	Chain	Res	Type
1	A	167	ASN
1	A	368	HIS
1	C	126	GLN
1	C	229	ASN
1	C	368	HIS
1	D	229	ASN
1	D	305	HIS
1	E	169	GLN
1	E	228	GLN
1	F	167	ASN
1	F	210	HIS
1	F	248	HIS
1	G	138	GLN
1	G	228	GLN
1	G	248	HIS
1	I	167	ASN
1	I	217	HIS
1	K	126	GLN
1	K	203	ASN
1	K	207	ASN
1	K	344	ASN
1	L	167	ASN
1	L	169	GLN

5.3.3 RNA [i](#)

There are no RNA molecules in this entry.

5.4 Non-standard residues in protein, DNA, RNA chains [i](#)

There are no non-standard protein/DNA/RNA residues in this entry.

5.5 Carbohydrates [i](#)

There are no monosaccharides in this entry.

5.6 Ligand geometry [i](#)

Of 40 ligands modelled in this entry, 12 are monoatomic - leaving 28 for Mogul analysis.

In the following table, the Counts columns list the number of bonds (or angles) for which Mogul statistics could be retrieved, the number of bonds (or angles) that are observed in the model and the number of bonds (or angles) that are defined in the Chemical Component Dictionary. The Link column lists molecule types, if any, to which the group is linked. The Z score for a bond length (or angle) is the number of standard deviations the observed value is removed from the expected value. A bond length (or angle) with $|Z| > 2$ is considered an outlier worth inspection. RMSZ is the root-mean-square of all Z scores of the bond lengths (or angles).

Mol	Type	Chain	Res	Link	Bond lengths			Bond angles		
					Counts	RMSZ	# Z > 2	Counts	RMSZ	# Z > 2
3	SR7	F	1396	-	33,39,39	2.07	9 (27%)	43,55,55	2.58	16 (37%)
2	CNA	F	1395	-	42,48,48	2.06	8 (19%)	49,73,73	1.73	7 (14%)
3	SR7	E	1396	-	33,39,39	2.54	9 (27%)	43,55,55	3.03	18 (41%)
2	CNA	E	1395	-	42,48,48	2.05	10 (23%)	49,73,73	1.88	11 (22%)
2	CNA	A	1395	-	42,48,48	2.19	12 (28%)	49,73,73	1.68	8 (16%)
3	SR7	L	1397	-	33,39,39	1.92	11 (33%)	43,55,55	2.22	10 (23%)
3	SR7	A	1396	-	33,39,39	2.52	9 (27%)	43,55,55	3.04	18 (41%)
3	SR7	G	1396	-	33,39,39	2.48	10 (30%)	43,55,55	2.55	19 (44%)
2	CNA	I	1395	-	42,48,48	2.21	11 (26%)	49,73,73	1.82	9 (18%)
2	CNA	C	1395	-	42,48,48	2.07	11 (26%)	49,73,73	1.53	9 (18%)
5	GOL	L	1396	-	5,5,5	0.30	0	5,5,5	0.64	0
3	SR7	C	1397	-	33,39,39	2.07	9 (27%)	43,55,55	2.19	15 (34%)
3	SR7	J	1396	-	33,39,39	2.00	9 (27%)	43,55,55	2.53	18 (41%)
2	CNA	J	1395	-	42,48,48	2.14	11 (26%)	49,73,73	1.51	8 (16%)
3	SR7	K	1397	-	33,39,39	2.25	9 (27%)	43,55,55	1.48	10 (23%)
5	GOL	C	1396	-	5,5,5	0.39	0	5,5,5	0.93	0
3	SR7	I	1396	-	33,39,39	2.28	8 (24%)	43,55,55	2.41	15 (34%)
5	GOL	D	1395	-	5,5,5	0.35	0	5,5,5	1.17	0
2	CNA	B	1395	-	42,48,48	2.28	12 (28%)	49,73,73	1.72	9 (18%)
2	CNA	D	1394	-	42,48,48	2.20	13 (30%)	49,73,73	1.57	10 (20%)
3	SR7	H	1396	-	33,39,39	2.42	6 (18%)	43,55,55	1.95	12 (27%)
2	CNA	K	1395	-	42,48,48	2.52	15 (35%)	49,73,73	1.75	8 (16%)
2	CNA	H	1395	-	42,48,48	2.28	13 (30%)	49,73,73	2.11	9 (18%)

Mol	Type	Chain	Res	Link	Bond lengths			Bond angles		
					Counts	RMSZ	# Z > 2	Counts	RMSZ	# Z > 2
3	SR7	D	1396	-	33,39,39	2.12	6 (18%)	43,55,55	1.50	6 (13%)
5	GOL	K	1396	-	5,5,5	0.26	0	5,5,5	0.56	0
2	CNA	L	1395	-	42,48,48	2.37	13 (30%)	49,73,73	1.74	11 (22%)
2	CNA	G	1395	-	42,48,48	2.17	9 (21%)	49,73,73	1.96	9 (18%)
3	SR7	B	1396	-	33,39,39	2.43	10 (30%)	43,55,55	3.11	18 (41%)

In the following table, the Chirals column lists the number of chiral outliers, the number of chiral centers analysed, the number of these observed in the model and the number defined in the Chemical Component Dictionary. Similar counts are reported in the Torsion and Rings columns. '-' means no outliers of that kind were identified.

Mol	Type	Chain	Res	Link	Chirals	Torsions	Rings
3	SR7	F	1396	-	-	6/15/24/24	1/6/6/6
2	CNA	F	1395	-	-	13/24/62/62	0/5/5/5
3	SR7	E	1396	-	-	6/15/24/24	1/6/6/6
2	CNA	E	1395	-	-	14/24/62/62	0/5/5/5
2	CNA	A	1395	-	-	6/24/62/62	0/5/5/5
3	SR7	L	1397	-	-	7/15/24/24	1/6/6/6
3	SR7	A	1396	-	-	6/15/24/24	1/6/6/6
3	SR7	G	1396	-	-	6/15/24/24	1/6/6/6
2	CNA	I	1395	-	-	12/24/62/62	0/5/5/5
2	CNA	C	1395	-	-	4/24/62/62	0/5/5/5
5	GOL	L	1396	-	-	1/4/4/4	-
3	SR7	C	1397	-	-	6/15/24/24	0/6/6/6
3	SR7	J	1396	-	-	6/15/24/24	1/6/6/6
2	CNA	J	1395	-	-	10/24/62/62	0/5/5/5
3	SR7	K	1397	-	-	6/15/24/24	0/6/6/6
5	GOL	C	1396	-	-	2/4/4/4	-
3	SR7	I	1396	-	-	5/15/24/24	0/6/6/6
5	GOL	D	1395	-	-	4/4/4/4	-
2	CNA	B	1395	-	-	6/24/62/62	0/5/5/5
2	CNA	D	1394	-	-	4/24/62/62	0/5/5/5
3	SR7	H	1396	-	-	6/15/24/24	0/6/6/6
2	CNA	K	1395	-	-	11/24/62/62	0/5/5/5
2	CNA	H	1395	-	-	15/24/62/62	0/5/5/5
3	SR7	D	1396	-	-	2/15/24/24	1/6/6/6

Continued on next page...

Continued from previous page...

Mol	Type	Chain	Res	Link	Chirals	Torsions	Rings
5	GOL	K	1396	-	-	2/4/4/4	-
2	CNA	L	1395	-	-	14/24/62/62	0/5/5/5
2	CNA	G	1395	-	-	15/24/62/62	0/5/5/5
3	SR7	B	1396	-	-	6/15/24/24	1/6/6/6

All (243) bond length outliers are listed below:

Mol	Chain	Res	Type	Atoms	Z	Observed(Å)	Ideal(Å)
3	E	1396	SR7	CBC-SBB	-8.93	1.59	1.70
3	G	1396	SR7	CBC-SBB	-8.86	1.59	1.70
3	A	1396	SR7	CBC-SBB	-8.56	1.60	1.70
3	H	1396	SR7	CBC-SBB	-8.28	1.60	1.70
2	L	1395	CNA	C3N-C7N	-8.20	1.38	1.50
2	D	1394	CNA	C3N-C7N	-8.06	1.38	1.50
2	B	1395	CNA	C3N-C7N	-7.91	1.38	1.50
2	C	1395	CNA	C3N-C7N	-7.90	1.38	1.50
2	K	1395	CNA	C2N-N1N	7.59	1.44	1.35
2	A	1395	CNA	C3N-C7N	-7.52	1.39	1.50
3	B	1396	SR7	CBC-SBB	-7.46	1.61	1.70
2	I	1395	CNA	C3N-C7N	-7.23	1.39	1.50
2	H	1395	CNA	C2N-N1N	7.06	1.43	1.35
2	K	1395	CNA	C2A-N3A	6.65	1.42	1.32
2	J	1395	CNA	C3N-C7N	-6.64	1.40	1.50
2	L	1395	CNA	C2A-N3A	6.50	1.42	1.32
2	H	1395	CNA	C3N-C7N	-6.41	1.40	1.50
2	F	1395	CNA	C3N-C7N	-6.33	1.41	1.50
3	I	1396	SR7	CBC-SBB	-6.31	1.62	1.70
2	G	1395	CNA	C3N-C7N	-6.19	1.41	1.50
3	D	1396	SR7	CBC-SBB	-6.13	1.63	1.70
2	E	1395	CNA	C2N-N1N	6.08	1.42	1.35
3	A	1396	SR7	CAH-NAI	-6.07	1.26	1.37
2	F	1395	CNA	C2N-N1N	5.91	1.42	1.35
2	G	1395	CNA	C2A-N3A	5.74	1.41	1.32
2	E	1395	CNA	C2A-N3A	5.70	1.41	1.32
2	G	1395	CNA	C2N-N1N	5.65	1.41	1.35
3	B	1396	SR7	CAH-NAI	-5.59	1.27	1.37
3	D	1396	SR7	CAC-CAZ	-5.58	1.34	1.48
3	H	1396	SR7	CAJ-NAI	5.50	1.40	1.31
2	B	1395	CNA	C2N-N1N	5.47	1.41	1.35
2	J	1395	CNA	C2A-N3A	5.32	1.40	1.32
2	K	1395	CNA	C3N-C7N	-5.30	1.42	1.50

Continued on next page...

Continued from previous page...

Mol	Chain	Res	Type	Atoms	Z	Observed(Å)	Ideal(Å)
2	I	1395	CNA	C2A-N3A	5.29	1.40	1.32
3	C	1397	SR7	CAC-CAZ	-5.27	1.35	1.48
3	H	1396	SR7	CAK-CBF	-5.26	1.37	1.50
3	E	1396	SR7	CAH-NAI	-5.26	1.28	1.37
3	K	1397	SR7	CAK-CBF	-5.19	1.38	1.50
2	E	1395	CNA	C3N-C7N	-5.12	1.42	1.50
2	G	1395	CNA	O4B-C1B	5.11	1.48	1.41
2	H	1395	CNA	C2A-N3A	5.06	1.40	1.32
3	F	1396	SR7	CAH-NAI	-5.06	1.28	1.37
2	L	1395	CNA	C2N-N1N	4.99	1.41	1.35
3	K	1397	SR7	CAJ-NAI	4.95	1.39	1.31
3	A	1396	SR7	CAB-NBE	-4.93	1.32	1.41
2	F	1395	CNA	C2A-N3A	4.93	1.40	1.32
2	B	1395	CNA	C2A-N3A	4.93	1.40	1.32
3	K	1397	SR7	CAB-NBE	-4.89	1.32	1.41
3	I	1396	SR7	CAK-CBF	-4.89	1.38	1.50
3	I	1396	SR7	CAJ-NAI	4.88	1.39	1.31
2	J	1395	CNA	C2N-N1N	4.87	1.40	1.35
3	D	1396	SR7	CAJ-NAI	4.81	1.39	1.31
2	C	1395	CNA	C2A-N3A	4.80	1.39	1.32
2	I	1395	CNA	C2N-N1N	4.78	1.40	1.35
3	I	1396	SR7	CAC-CAZ	-4.76	1.36	1.48
2	D	1394	CNA	C2A-N3A	4.73	1.39	1.32
2	K	1395	CNA	C2A-N1A	4.72	1.42	1.33
3	B	1396	SR7	CAC-CAZ	-4.69	1.36	1.48
3	F	1396	SR7	CAC-CAZ	-4.68	1.36	1.48
2	A	1395	CNA	C2A-N3A	4.62	1.39	1.32
3	K	1397	SR7	CAC-CAZ	-4.57	1.36	1.48
3	J	1396	SR7	CAH-NAI	-4.56	1.29	1.37
3	E	1396	SR7	CAB-NBE	-4.54	1.33	1.41
2	D	1394	CNA	C2B-C1B	-4.53	1.46	1.53
3	J	1396	SR7	CAC-CAZ	-4.52	1.37	1.48
3	G	1396	SR7	CAC-CAZ	-4.45	1.37	1.48
3	C	1397	SR7	CAH-NAI	-4.39	1.29	1.37
2	L	1395	CNA	C2A-N1A	4.36	1.42	1.33
3	F	1396	SR7	CAB-NBE	-4.33	1.33	1.41
3	L	1397	SR7	CAK-CBF	-4.32	1.40	1.50
2	J	1395	CNA	O4B-C1B	4.27	1.47	1.41
3	G	1396	SR7	CAH-NAI	-4.27	1.29	1.37
3	G	1396	SR7	CAB-NBE	-4.27	1.33	1.41
3	G	1396	SR7	CAJ-NAI	4.24	1.38	1.31
2	E	1395	CNA	O4B-C1B	4.23	1.47	1.41

Continued on next page...

Continued from previous page...

Mol	Chain	Res	Type	Atoms	Z	Observed(Å)	Ideal(Å)
3	I	1396	SR7	CAB-NBE	-4.16	1.33	1.41
2	C	1395	CNA	C2N-N1N	4.15	1.40	1.35
2	A	1395	CNA	C2D-C1D	-4.10	1.48	1.53
3	E	1396	SR7	CAC-CAZ	-4.09	1.38	1.48
3	C	1397	SR7	CAB-NBE	-4.09	1.34	1.41
3	E	1396	SR7	CAJ-NAI	4.07	1.38	1.31
2	A	1395	CNA	C2N-N1N	4.06	1.39	1.35
3	H	1396	SR7	CAC-CAZ	-4.04	1.38	1.48
3	J	1396	SR7	CAJ-NAI	4.01	1.38	1.31
3	C	1397	SR7	CAK-CBF	-3.92	1.41	1.50
2	I	1395	CNA	O4B-C1B	3.87	1.46	1.41
3	A	1396	SR7	CAC-CAZ	-3.86	1.38	1.48
3	B	1396	SR7	CAK-CBF	-3.84	1.41	1.50
3	A	1396	SR7	CAK-CBF	-3.84	1.41	1.50
3	B	1396	SR7	CAB-NBE	-3.84	1.34	1.41
2	J	1395	CNA	C2A-N1A	3.80	1.41	1.33
3	L	1397	SR7	CAC-CAZ	-3.78	1.38	1.48
3	L	1397	SR7	CAJ-NAI	3.77	1.37	1.31
3	F	1396	SR7	CBC-SBB	-3.73	1.66	1.70
3	D	1396	SR7	CAK-CBF	-3.73	1.41	1.50
3	J	1396	SR7	CAB-NBE	-3.71	1.34	1.41
2	B	1395	CNA	C5A-C4A	-3.70	1.31	1.40
2	K	1395	CNA	PN-O2N	3.69	1.72	1.55
2	K	1395	CNA	O3B-C3B	3.69	1.51	1.43
2	F	1395	CNA	O4B-C1B	3.68	1.46	1.41
3	I	1396	SR7	CAH-NAI	-3.66	1.31	1.37
3	C	1397	SR7	CBC-SBB	-3.64	1.66	1.70
2	D	1394	CNA	C2N-N1N	3.61	1.39	1.35
3	B	1396	SR7	CAP-CAG	-3.59	1.35	1.41
2	A	1395	CNA	C5A-C4A	-3.59	1.31	1.40
3	K	1397	SR7	CBC-SBB	3.58	1.75	1.70
3	E	1396	SR7	CAK-CBF	-3.58	1.41	1.50
2	H	1395	CNA	O4B-C1B	3.56	1.46	1.41
3	H	1396	SR7	CAB-NBE	-3.55	1.35	1.41
2	D	1394	CNA	C4A-N3A	-3.54	1.30	1.35
3	J	1396	SR7	CBC-SBB	-3.52	1.66	1.70
3	L	1397	SR7	CAB-NBE	-3.43	1.35	1.41
2	I	1395	CNA	C2A-N1A	3.41	1.40	1.33
3	F	1396	SR7	CAP-CAG	-3.41	1.35	1.41
3	L	1397	SR7	CAH-NAI	-3.40	1.31	1.37
2	K	1395	CNA	PA-O1A	3.37	1.71	1.55
2	B	1395	CNA	C6A-C5A	-3.35	1.30	1.43

Continued on next page...

Continued from previous page...

Mol	Chain	Res	Type	Atoms	Z	Observed(Å)	Ideal(Å)
3	K	1397	SR7	CAH-NAI	-3.30	1.31	1.37
2	E	1395	CNA	C5A-C4A	-3.29	1.32	1.40
3	J	1396	SR7	CAK-CBF	-3.29	1.42	1.50
3	A	1396	SR7	CAP-CAG	-3.27	1.36	1.41
3	F	1396	SR7	CBH-CBD	3.26	1.56	1.51
2	I	1395	CNA	C6A-C5A	-3.21	1.31	1.43
3	F	1396	SR7	CAK-CBF	-3.21	1.42	1.50
2	L	1395	CNA	PA-O1A	3.19	1.70	1.55
2	K	1395	CNA	C2D-C1D	3.19	1.57	1.53
2	D	1394	CNA	C2A-N1A	3.18	1.39	1.33
3	C	1397	SR7	CAJ-NAI	3.16	1.36	1.31
2	L	1395	CNA	O3B-C3B	3.14	1.50	1.43
2	G	1395	CNA	C6N-N1N	3.13	1.43	1.35
2	A	1395	CNA	C6A-C5A	-3.12	1.31	1.43
2	C	1395	CNA	C2A-N1A	3.11	1.39	1.33
2	F	1395	CNA	C6A-C5A	-3.09	1.31	1.43
3	J	1396	SR7	CAP-CAG	-3.09	1.36	1.41
2	H	1395	CNA	C2A-N1A	3.08	1.39	1.33
2	I	1395	CNA	C5A-C4A	-3.08	1.32	1.40
3	D	1396	SR7	CAB-NBE	-3.06	1.35	1.41
3	E	1396	SR7	CAP-CAG	-3.05	1.36	1.41
2	F	1395	CNA	C2A-N1A	3.05	1.39	1.33
2	B	1395	CNA	C5A-N7A	-3.02	1.28	1.39
3	F	1396	SR7	CAJ-NAI	3.00	1.36	1.31
3	B	1396	SR7	CAJ-NAI	2.99	1.36	1.31
3	B	1396	SR7	CAQ-CAR	-2.96	1.44	1.51
2	G	1395	CNA	C2A-N1A	2.95	1.39	1.33
2	C	1395	CNA	C4A-N3A	-2.95	1.31	1.35
2	H	1395	CNA	C5A-C4A	-2.94	1.33	1.40
2	H	1395	CNA	C6N-N1N	2.93	1.42	1.35
2	E	1395	CNA	C6A-C5A	-2.91	1.32	1.43
3	G	1396	SR7	CAK-CBF	-2.91	1.43	1.50
2	H	1395	CNA	O3B-C3B	2.88	1.49	1.43
2	H	1395	CNA	C6A-C5A	-2.88	1.32	1.43
3	J	1396	SR7	CBH-CBD	2.86	1.55	1.51
2	B	1395	CNA	PN-O5D	-2.86	1.47	1.59
2	J	1395	CNA	C6A-C5A	-2.86	1.32	1.43
2	F	1395	CNA	C5A-C4A	-2.84	1.33	1.40
3	K	1397	SR7	CAU-CAT	2.83	1.58	1.51
2	C	1395	CNA	C5A-C4A	-2.80	1.33	1.40
2	E	1395	CNA	C2A-N1A	2.78	1.39	1.33
2	G	1395	CNA	C5A-C4A	-2.77	1.33	1.40

Continued on next page...

Continued from previous page...

Mol	Chain	Res	Type	Atoms	Z	Observed(Å)	Ideal(Å)
3	E	1396	SR7	CBH-CBD	2.76	1.55	1.51
2	D	1394	CNA	C5A-C4A	-2.76	1.33	1.40
2	C	1395	CNA	C2B-C1B	-2.76	1.49	1.53
2	A	1395	CNA	C2B-C1B	-2.74	1.49	1.53
2	L	1395	CNA	PN-O5D	2.72	1.70	1.59
2	B	1395	CNA	C2B-C1B	-2.70	1.49	1.53
3	G	1396	SR7	CAH-CAG	-2.70	1.36	1.42
3	G	1396	SR7	CAP-CAG	-2.70	1.37	1.41
2	J	1395	CNA	O2B-C2B	2.70	1.49	1.43
3	G	1396	SR7	CBH-CBD	2.69	1.55	1.51
3	L	1397	SR7	CAC-CAB	2.68	1.44	1.40
2	A	1395	CNA	C5D-C4D	2.66	1.57	1.51
3	H	1396	SR7	CAP-CAG	-2.66	1.37	1.41
2	D	1394	CNA	C6A-C5A	-2.66	1.33	1.43
2	L	1395	CNA	C6N-N1N	2.65	1.41	1.35
3	C	1397	SR7	CAQ-CAR	-2.64	1.45	1.51
3	K	1397	SR7	CAQ-CAR	2.64	1.57	1.51
3	C	1397	SR7	CAU-CAT	2.64	1.57	1.51
2	H	1395	CNA	C2N-C3N	2.64	1.43	1.39
2	I	1395	CNA	C2D-C1D	2.62	1.56	1.53
2	K	1395	CNA	C2N-C3N	2.60	1.43	1.39
2	J	1395	CNA	C5A-C4A	-2.58	1.34	1.40
2	B	1395	CNA	C4A-N3A	-2.56	1.32	1.35
2	A	1395	CNA	PN-O5D	-2.55	1.49	1.59
2	G	1395	CNA	C6A-C5A	-2.52	1.33	1.43
2	A	1395	CNA	C5A-N7A	-2.52	1.30	1.39
2	L	1395	CNA	PN-O2N	2.48	1.67	1.55
2	B	1395	CNA	C2D-C1D	-2.48	1.50	1.53
2	C	1395	CNA	C6A-C5A	-2.48	1.34	1.43
3	D	1396	SR7	CAH-NAI	-2.48	1.33	1.37
3	A	1396	SR7	CAJ-NAI	2.46	1.35	1.31
2	I	1395	CNA	C6N-N1N	2.45	1.41	1.35
2	B	1395	CNA	C2A-N1A	2.40	1.38	1.33
2	H	1395	CNA	O2B-C2B	2.39	1.48	1.43
2	K	1395	CNA	C6N-N1N	2.38	1.41	1.35
2	L	1395	CNA	C5B-C4B	2.38	1.59	1.51
3	A	1396	SR7	CAO-CAH	-2.38	1.37	1.41
2	K	1395	CNA	O3D-C3D	2.36	1.48	1.43
2	G	1395	CNA	C2N-C3N	2.35	1.42	1.39
2	A	1395	CNA	C4D-C3D	-2.34	1.47	1.54
3	L	1397	SR7	CBC-SBB	2.33	1.73	1.70
2	D	1394	CNA	PA-O1A	2.32	1.66	1.55

Continued on next page...

Continued from previous page...

Mol	Chain	Res	Type	Atoms	Z	Observed(Å)	Ideal(Å)
2	I	1395	CNA	C5A-N7A	-2.32	1.31	1.39
3	I	1396	SR7	CAP-CAG	-2.31	1.37	1.41
2	L	1395	CNA	C5A-C4A	-2.31	1.34	1.40
3	L	1397	SR7	CAU-CAT	2.27	1.56	1.51
2	B	1395	CNA	C4'-C4D	-2.27	1.47	1.53
3	F	1396	SR7	CAO-CAH	-2.26	1.37	1.41
2	D	1394	CNA	O2D-C2D	-2.24	1.37	1.43
2	D	1394	CNA	C5A-N7A	-2.24	1.31	1.39
2	K	1395	CNA	C5A-C4A	-2.24	1.35	1.40
3	C	1397	SR7	CAP-CAG	-2.23	1.38	1.41
2	J	1395	CNA	O3B-C3B	2.23	1.48	1.43
2	K	1395	CNA	C6A-C5A	-2.23	1.35	1.43
3	B	1396	SR7	CAM-CAP	2.22	1.41	1.36
2	C	1395	CNA	C5A-N7A	-2.22	1.31	1.39
3	L	1397	SR7	CAM-CAP	2.18	1.41	1.36
2	K	1395	CNA	PA-O5B	2.18	1.68	1.59
3	G	1396	SR7	CAO-CAH	-2.18	1.38	1.41
3	B	1396	SR7	CAC-CAB	2.18	1.43	1.40
2	C	1395	CNA	O3D-C3D	2.18	1.48	1.43
3	E	1396	SR7	CAO-CAH	-2.18	1.38	1.41
2	J	1395	CNA	C6N-N1N	2.17	1.40	1.35
3	I	1396	SR7	CBH-CBD	2.15	1.54	1.51
2	I	1395	CNA	C4A-N3A	-2.14	1.32	1.35
2	C	1395	CNA	O3B-C3B	2.14	1.48	1.43
2	H	1395	CNA	C4D-C3D	-2.13	1.48	1.54
2	L	1395	CNA	PA-O5B	2.11	1.67	1.59
2	F	1395	CNA	C4'-C1D	-2.11	1.46	1.53
3	A	1396	SR7	CAQ-CAR	-2.11	1.46	1.51
2	E	1395	CNA	O2B-C2B	2.10	1.47	1.43
3	K	1397	SR7	CAP-CAG	-2.10	1.38	1.41
3	J	1396	SR7	CAQ-CAR	-2.09	1.46	1.51
2	L	1395	CNA	C6A-C5A	-2.07	1.35	1.43
3	L	1397	SR7	CAD-CAC	2.07	1.43	1.40
2	D	1394	CNA	O3B-C3B	2.06	1.47	1.43
3	L	1397	SR7	CAP-CAG	-2.06	1.38	1.41
2	D	1394	CNA	C5D-C4D	2.06	1.55	1.51
2	J	1395	CNA	C5A-N7A	-2.05	1.32	1.39
2	A	1395	CNA	C4A-N3A	-2.04	1.32	1.35
2	H	1395	CNA	C2D-C1D	2.02	1.55	1.53
2	E	1395	CNA	O2D-C2D	2.02	1.47	1.43
2	K	1395	CNA	PN-O5D	2.01	1.67	1.59
2	E	1395	CNA	C5A-N7A	-2.01	1.32	1.39

All (283) bond angle outliers are listed below:

Mol	Chain	Res	Type	Atoms	Z	Observed(°)	Ideal(°)
3	E	1396	SR7	CBH-CBD-CBC	-9.32	116.99	129.46
3	B	1396	SR7	CAJ-CAK-CBF	-9.28	109.75	119.62
3	A	1396	SR7	CAJ-CAK-CBF	-9.10	109.94	119.62
3	B	1396	SR7	CAO-CAH-CAG	9.06	130.53	119.25
3	A	1396	SR7	CAO-CAH-CAG	8.28	129.56	119.25
3	I	1396	SR7	CAJ-CAK-CBF	-7.77	111.36	119.62
3	G	1396	SR7	CBH-CBD-CBC	-7.74	119.10	129.46
2	H	1395	CNA	C6N-N1N-C2N	-7.20	115.41	121.97
3	E	1396	SR7	CAJ-CAK-CBF	-7.09	112.08	119.62
3	E	1396	SR7	CAO-CAH-CAG	7.05	128.03	119.25
3	F	1396	SR7	CAO-CAH-CAG	6.87	127.81	119.25
3	L	1397	SR7	CBH-CBD-CBC	-6.77	120.40	129.46
3	A	1396	SR7	CBF-CAK-NAL	6.74	134.50	116.94
3	B	1396	SR7	CBF-CAK-NAL	6.67	134.31	116.94
2	E	1395	CNA	N3A-C2A-N1A	-6.61	118.35	128.68
2	H	1395	CNA	N3A-C2A-N1A	-6.58	118.40	128.68
3	L	1397	SR7	CAJ-CAK-CBF	-6.57	112.63	119.62
3	J	1396	SR7	CBH-CBD-CBC	-6.49	120.77	129.46
3	B	1396	SR7	CAP-CAG-CAH	-6.44	111.24	119.25
3	J	1396	SR7	CAO-CAH-CAG	6.43	127.25	119.25
2	F	1395	CNA	N3A-C2A-N1A	-6.42	118.64	128.68
3	A	1396	SR7	CAP-CAG-CAH	-6.35	111.35	119.25
3	H	1396	SR7	CBH-CBD-CBC	-6.21	121.15	129.46
2	L	1395	CNA	N3A-C2A-N1A	-6.19	119.01	128.68
3	F	1396	SR7	CAJ-CAK-CBF	-6.18	113.04	119.62
2	A	1395	CNA	N3A-C2A-N1A	-5.99	119.32	128.68
2	G	1395	CNA	N3A-C2A-N1A	-5.97	119.34	128.68
2	J	1395	CNA	N3A-C2A-N1A	-5.95	119.37	128.68
2	I	1395	CNA	N3A-C2A-N1A	-5.88	119.49	128.68
3	E	1396	SR7	CBF-CAK-NAL	5.86	132.19	116.94
3	F	1396	SR7	CBH-CBD-CBC	-5.80	121.70	129.46
3	C	1397	SR7	CAJ-CAK-CBF	-5.70	113.55	119.62
3	J	1396	SR7	CAJ-CAK-CBF	-5.70	113.56	119.62
2	B	1395	CNA	N3A-C2A-N1A	-5.67	119.82	128.68
2	I	1395	CNA	C6N-N1N-C2N	-5.63	116.84	121.97
3	F	1396	SR7	CBF-CAK-NAL	5.61	131.55	116.94
2	K	1395	CNA	N3A-C2A-N1A	-5.61	119.91	128.68
3	G	1396	SR7	CBF-CAK-NAL	5.52	131.32	116.94
2	G	1395	CNA	C6N-N1N-C2N	-5.52	116.94	121.97
3	C	1397	SR7	CAO-CAH-CAG	5.46	126.05	119.25
3	J	1396	SR7	CBF-CAK-NAL	5.23	130.56	116.94
3	I	1396	SR7	CAO-CAH-CAG	5.22	125.75	119.25

Continued on next page...

Continued from previous page...

Mol	Chain	Res	Type	Atoms	Z	Observed(°)	Ideal(°)
2	C	1395	CNA	N3A-C2A-N1A	-5.17	120.60	128.68
3	E	1396	SR7	CAB-CAC-CAZ	4.96	128.58	123.34
3	I	1396	SR7	CBF-CAK-NAL	4.88	129.66	116.94
2	K	1395	CNA	C6N-N1N-C2N	-4.81	117.59	121.97
3	C	1397	SR7	CBF-CAK-NAL	4.81	129.47	116.94
2	F	1395	CNA	C4'-C1D-C2D	-4.79	96.99	104.53
3	D	1396	SR7	CBH-CBD-CBC	-4.78	123.07	129.46
3	I	1396	SR7	CBH-CBD-CBC	-4.76	123.09	129.46
3	G	1396	SR7	CAJ-CAK-CBF	-4.66	114.66	119.62
3	B	1396	SR7	CAG-CAH-NAI	-4.65	116.56	121.00
2	H	1395	CNA	C1B-N9A-C4A	-4.64	118.49	126.64
3	H	1396	SR7	CAR-CAQ-NAV	-4.63	104.31	110.94
3	L	1397	SR7	CBF-CAK-NAL	4.63	128.99	116.94
2	G	1395	CNA	C4'-C1D-N1N	-4.59	107.25	113.39
2	B	1395	CNA	C6N-N1N-C2N	-4.52	117.85	121.97
2	I	1395	CNA	O4B-C1B-C2B	-4.51	100.33	106.93
2	D	1394	CNA	N3A-C2A-N1A	-4.39	121.82	128.68
3	F	1396	SR7	CAP-CAG-CAH	-4.36	113.83	119.25
3	B	1396	SR7	CBH-CBD-CBC	-4.27	123.74	129.46
2	E	1395	CNA	C6N-N1N-C2N	-4.27	118.08	121.97
3	A	1396	SR7	CAB-CAC-CAZ	4.11	127.68	123.34
2	G	1395	CNA	PN-O3-PA	-4.07	118.86	132.83
3	A	1396	SR7	CBH-CBD-CBC	-4.05	124.04	129.46
2	L	1395	CNA	C2N-C3N-C4N	4.04	122.83	118.26
2	L	1395	CNA	C6N-N1N-C2N	-4.03	118.30	121.97
2	E	1395	CNA	C5A-C6A-N6A	-4.03	114.23	120.35
2	A	1395	CNA	C4'-C1D-N1N	-4.02	108.01	113.39
2	J	1395	CNA	C6N-N1N-C2N	-3.98	118.34	121.97
3	L	1397	SR7	CAO-CAH-CAG	3.94	124.16	119.25
2	G	1395	CNA	C3D-C2D-C1D	-3.93	96.14	102.45
3	E	1396	SR7	CAP-CAG-CAH	-3.93	114.36	119.25
3	A	1396	SR7	CAG-CAH-NAI	-3.88	117.30	121.00
3	L	1397	SR7	CAP-CAG-CAH	-3.83	114.49	119.25
3	I	1396	SR7	CAT-CAU-NAV	3.82	116.42	110.94
3	G	1396	SR7	CAG-CAH-NAI	-3.81	117.36	121.00
2	I	1395	CNA	C5A-C6A-N6A	-3.81	114.57	120.35
2	H	1395	CNA	C4'-C1D-N1N	-3.79	108.32	113.39
3	C	1397	SR7	CAP-CAG-CAH	-3.79	114.54	119.25
2	H	1395	CNA	C5A-C6A-N6A	-3.76	114.63	120.35
3	G	1396	SR7	CAO-CAH-CAG	3.74	123.91	119.25
3	H	1396	SR7	CAJ-CAK-CBF	-3.73	115.66	119.62
2	F	1395	CNA	C5A-C6A-N6A	-3.72	114.70	120.35

Continued on next page...

Continued from previous page...

Mol	Chain	Res	Type	Atoms	Z	Observed(°)	Ideal(°)
3	B	1396	SR7	CAB-CAC-CAZ	3.72	127.27	123.34
3	B	1396	SR7	CAN-CAM-CAP	3.69	125.61	120.44
2	A	1395	CNA	C6N-N1N-C2N	-3.67	118.63	121.97
3	J	1396	SR7	CAP-CAG-CAH	-3.63	114.73	119.25
3	B	1396	SR7	CAH-CAG-NAL	3.63	125.92	121.18
2	D	1394	CNA	C4'-C4D-C5D	-3.62	105.67	112.68
2	H	1395	CNA	PN-O3-PA	-3.60	120.47	132.83
2	B	1395	CNA	C4'-C4D-C5D	-3.59	105.74	112.68
3	G	1396	SR7	CAJ-CAK-NAL	-3.56	113.81	121.51
3	A	1396	SR7	CAH-CAG-NAL	3.56	125.82	121.18
3	B	1396	SR7	CAM-CAN-CAO	-3.50	115.53	120.44
3	K	1397	SR7	CAO-CAH-CAG	3.49	123.60	119.25
3	J	1396	SR7	CAG-CAH-NAI	-3.43	117.73	121.00
3	C	1397	SR7	CBH-CBD-CBC	-3.43	124.87	129.46
3	I	1396	SR7	CAR-CAQ-NAV	-3.43	106.03	110.94
3	B	1396	SR7	CAO-CAH-NAI	-3.43	112.91	118.52
3	E	1396	SR7	CAH-CAG-NAL	3.40	125.62	121.18
2	A	1395	CNA	C5A-C6A-N6A	-3.40	115.18	120.35
3	C	1397	SR7	CBD-CBH-NAV	-3.40	104.97	113.06
2	K	1395	CNA	O4B-C1B-C2B	-3.35	102.03	106.93
2	G	1395	CNA	C5A-C6A-N6A	-3.35	115.27	120.35
3	E	1396	SR7	CAD-CAC-CAB	-3.34	114.55	117.92
3	F	1396	SR7	CAG-CAH-NAI	-3.33	117.82	121.00
3	I	1396	SR7	CAP-CAG-CAH	-3.31	115.13	119.25
3	G	1396	SR7	CAB-CAC-CAZ	3.29	126.82	123.34
3	A	1396	SR7	CAO-CAH-NAI	-3.29	113.14	118.52
3	G	1396	SR7	CAP-CAG-CAH	-3.26	115.20	119.25
2	E	1395	CNA	PN-O3-PA	-3.24	121.69	132.83
2	K	1395	CNA	C4N-C3N-C7N	-3.24	112.37	121.04
2	C	1395	CNA	C3B-C2B-C1B	3.23	105.84	100.98
2	D	1394	CNA	C6N-N1N-C2N	-3.23	119.03	121.97
2	D	1394	CNA	O4B-C1B-C2B	-3.20	102.24	106.93
3	G	1396	SR7	CAK-NAL-CAG	3.20	122.22	117.51
3	J	1396	SR7	CAH-CAG-NAL	3.19	125.34	121.18
3	G	1396	SR7	CAM-CAN-CAO	-3.18	115.98	120.44
3	E	1396	SR7	CAZ-CBA-NAW	3.14	111.10	107.84
2	C	1395	CNA	C6N-N1N-C2N	-3.11	119.14	121.97
3	D	1396	SR7	CAT-CAU-NAV	3.10	115.39	110.94
3	G	1396	SR7	CAR-CAQ-NAV	-3.08	106.54	110.94
3	E	1396	SR7	CAZ-NAY-CAX	3.05	110.22	103.91
2	L	1395	CNA	PN-O3-PA	-3.01	122.50	132.83
3	I	1396	SR7	CBD-CBH-NAV	-3.01	105.90	113.06

Continued on next page...

Continued from previous page...

Mol	Chain	Res	Type	Atoms	Z	Observed(°)	Ideal(°)
2	D	1394	CNA	O4B-C4B-C5B	-3.00	99.50	109.37
3	H	1396	SR7	OBG-CBF-NBE	3.00	130.57	123.71
3	F	1396	SR7	CAZ-NAY-CAX	2.98	110.09	103.91
3	A	1396	SR7	CAM-CAN-CAO	-2.98	116.26	120.44
3	F	1396	SR7	CAZ-CBA-NAW	2.98	110.94	107.84
2	K	1395	CNA	C3B-C2B-C1B	2.98	105.46	100.98
3	D	1396	SR7	CBH-NAV-CAU	-2.97	104.45	111.06
2	E	1395	CNA	O2N-PN-O5D	-2.97	93.97	107.75
2	C	1395	CNA	O5B-PA-O2A	2.96	120.63	109.07
3	E	1396	SR7	CAO-CAH-NAI	-2.95	113.68	118.52
3	E	1396	SR7	CAQ-CAR-NAS	-2.95	103.47	111.12
3	E	1396	SR7	CAK-CBF-NBE	-2.94	106.92	114.04
2	B	1395	CNA	C5A-C6A-N6A	-2.92	115.91	120.35
3	H	1396	SR7	CAB-CAC-CAZ	2.90	126.41	123.34
2	B	1395	CNA	C1B-N9A-C4A	2.90	131.73	126.64
3	L	1397	SR7	CAG-CAH-NAI	-2.89	118.24	121.00
2	L	1395	CNA	C4'-C4D-C5D	-2.89	107.09	112.68
3	I	1396	SR7	CAH-CAG-NAL	2.86	124.91	121.18
3	E	1396	SR7	CAG-CAH-NAI	-2.84	118.29	121.00
3	H	1396	SR7	CAK-CBF-NBE	-2.84	107.15	114.04
3	H	1396	SR7	CAK-CAJ-NAI	-2.83	118.34	122.72
3	F	1396	SR7	CAJ-CAK-NAL	-2.83	115.40	121.51
2	F	1395	CNA	C6N-N1N-C2N	-2.82	119.40	121.97
2	G	1395	CNA	O3D-C3D-C4D	-2.82	105.45	112.75
3	G	1396	SR7	CAD-CAC-CAB	-2.81	115.09	117.92
3	L	1397	SR7	CAM-CAN-CAO	-2.81	116.51	120.44
3	A	1396	SR7	CAZ-NAY-CAX	2.79	109.69	103.91
3	H	1396	SR7	CAT-CAU-NAV	2.79	114.94	110.94
3	G	1396	SR7	CAK-CBF-NBE	-2.79	107.28	114.04
3	A	1396	SR7	CAJ-CAK-NAL	-2.78	115.51	121.51
3	K	1397	SR7	CAQ-CAR-NAS	-2.78	103.92	111.12
2	F	1395	CNA	PN-O3-PA	-2.76	123.36	132.83
2	K	1395	CNA	C2N-C3N-C7N	2.75	127.46	119.46
3	B	1396	SR7	CAP-CAG-NAL	2.73	122.85	118.69
3	A	1396	SR7	CAZ-CBA-NAW	2.72	110.67	107.84
2	J	1395	CNA	C3N-C7N-N7N	-2.72	114.49	117.75
3	A	1396	SR7	CAP-CAG-NAL	2.72	122.84	118.69
3	J	1396	SR7	CBH-NAV-CAU	-2.71	105.02	111.06
3	E	1396	SR7	CAJ-CAK-NAL	-2.71	115.66	121.51
3	J	1396	SR7	CAZ-NAY-CAX	2.70	109.49	103.91
2	I	1395	CNA	C4'-C1D-N1N	-2.69	109.79	113.39
3	C	1397	SR7	CAR-CAQ-NAV	-2.68	107.10	110.94

Continued on next page...

Continued from previous page...

Mol	Chain	Res	Type	Atoms	Z	Observed(°)	Ideal(°)
2	D	1394	CNA	C4A-C5A-N7A	-2.68	106.61	109.40
3	B	1396	SR7	CAZ-NAY-CAX	2.66	109.42	103.91
3	E	1396	SR7	CAK-CAJ-NAI	2.66	126.83	122.72
2	J	1395	CNA	PN-O3-PA	-2.62	123.82	132.83
3	C	1397	SR7	CAM-CAN-CAO	-2.62	116.76	120.44
3	F	1396	SR7	CAH-CAG-NAL	2.62	124.60	121.18
3	C	1397	SR7	CAG-CAH-NAI	-2.62	118.50	121.00
2	C	1395	CNA	C4A-C5A-N7A	-2.61	106.67	109.40
3	J	1396	SR7	CAJ-CAK-NAL	-2.61	115.86	121.51
3	A	1396	SR7	CAN-CAM-CAP	2.61	124.11	120.44
2	C	1395	CNA	O4B-C1B-C2B	-2.61	103.11	106.93
3	J	1396	SR7	CAN-CAO-CAH	-2.61	116.33	120.08
3	G	1396	SR7	CAJ-NAI-CAH	2.60	120.04	116.91
3	A	1396	SR7	CAK-CAJ-NAI	2.59	126.72	122.72
3	B	1396	SR7	CAJ-CAK-NAL	-2.58	115.94	121.51
3	F	1396	SR7	CBH-NAV-CAU	-2.57	105.34	111.06
2	H	1395	CNA	O3D-C3D-C4D	-2.56	106.12	112.75
3	F	1396	SR7	CAT-CAU-NAV	2.55	114.60	110.94
3	J	1396	SR7	CAB-CAC-CAZ	2.54	126.03	123.34
3	J	1396	SR7	CAK-CBF-NBE	-2.54	107.88	114.04
3	G	1396	SR7	CAZ-NAY-CAX	2.54	109.17	103.91
3	F	1396	SR7	CAO-CAH-NAI	-2.54	114.36	118.52
3	E	1396	SR7	CAN-CAO-CAH	-2.53	116.44	120.08
3	K	1397	SR7	CAH-CAG-NAL	2.52	124.46	121.18
2	A	1395	CNA	PN-O3-PA	-2.50	124.25	132.83
2	L	1395	CNA	C5A-C6A-N6A	-2.49	116.57	120.35
3	K	1397	SR7	CBF-CAK-NAL	2.49	123.41	116.94
2	E	1395	CNA	C4'-C4D-C5D	-2.48	107.87	112.68
3	F	1396	SR7	CAB-CAC-CAZ	2.48	125.96	123.34
2	A	1395	CNA	O2B-C2B-C3B	-2.48	103.81	111.82
3	C	1397	SR7	CAH-CAG-NAL	2.48	124.41	121.18
3	J	1396	SR7	CAT-CAU-NAV	2.47	114.49	110.94
2	H	1395	CNA	C4'-C4D-C5D	2.47	117.47	112.68
2	B	1395	CNA	C3N-C7N-N7N	-2.47	114.79	117.75
3	I	1396	SR7	CAK-CBF-NBE	-2.46	108.07	114.04
3	D	1396	SR7	CAK-NAL-CAG	2.45	121.12	117.51
3	D	1396	SR7	CBF-CAK-NAL	2.45	123.32	116.94
3	K	1397	SR7	CAJ-CAK-CBF	-2.45	117.02	119.62
2	I	1395	CNA	N6A-C6A-N1A	2.42	123.59	118.57
3	J	1396	SR7	CAB-NBE-CBF	2.41	133.55	126.93
3	G	1396	SR7	OBG-CBF-CAK	2.41	126.33	121.08
2	A	1395	CNA	C4'-C4D-C5D	-2.39	108.06	112.68

Continued on next page...

Continued from previous page...

Mol	Chain	Res	Type	Atoms	Z	Observed(°)	Ideal(°)
2	J	1395	CNA	C5A-C6A-N6A	-2.38	116.73	120.35
3	A	1396	SR7	CAT-CAU-NAV	2.36	114.33	110.94
2	E	1395	CNA	O5B-PA-O2A	2.36	118.31	109.07
2	I	1395	CNA	C2N-C3N-C4N	2.35	120.92	118.26
2	C	1395	CNA	C4'-C4D-C5D	-2.35	108.14	112.68
3	B	1396	SR7	CBH-NAV-CAU	-2.32	105.89	111.06
3	E	1396	SR7	CAN-CAM-CAP	2.32	123.69	120.44
2	L	1395	CNA	C4'-C4D-C3D	2.31	108.34	102.66
2	B	1395	CNA	O4B-C1B-C2B	-2.31	103.55	106.93
3	L	1397	SR7	CAU-NAV-CAQ	2.31	114.03	108.83
3	F	1396	SR7	CAN-CAO-CAH	-2.31	116.76	120.08
3	L	1397	SR7	CAZ-NAY-CAX	2.30	108.68	103.91
2	E	1395	CNA	O5B-C5B-C4B	-2.30	101.07	108.99
2	I	1395	CNA	C4'-C4D-C3D	2.30	108.30	102.66
2	H	1395	CNA	C2N-C3N-C4N	2.29	120.86	118.26
3	G	1396	SR7	CAP-CAG-NAL	2.28	122.17	118.69
2	C	1395	CNA	C2N-C3N-C4N	2.27	120.83	118.26
3	I	1396	SR7	CBA-CAZ-CAC	-2.27	124.03	129.15
3	I	1396	SR7	OBG-CBF-NBE	2.27	128.89	123.71
2	G	1395	CNA	O2D-C2D-C3D	-2.26	104.50	111.82
2	K	1395	CNA	O7N-C7N-C3N	2.26	122.34	119.63
3	A	1396	SR7	CAR-CAQ-NAV	-2.26	107.71	110.94
2	L	1395	CNA	O7N-C7N-C3N	-2.25	116.94	119.63
3	B	1396	SR7	CAN-CAO-CAH	-2.24	116.86	120.08
3	J	1396	SR7	OBG-CBF-NBE	2.24	128.82	123.71
3	H	1396	SR7	CAZ-NAY-CAX	2.24	108.54	103.91
3	I	1396	SR7	CBH-NAV-CAQ	2.24	116.03	111.06
3	G	1396	SR7	CAZ-CBA-NAW	2.23	110.15	107.84
2	I	1395	CNA	PA-O5B-C5B	-2.23	108.62	121.68
2	K	1395	CNA	C5A-C6A-N6A	-2.22	116.97	120.35
2	L	1395	CNA	C3B-C2B-C1B	2.22	104.32	100.98
3	C	1397	SR7	CAU-NAV-CAQ	2.21	113.81	108.83
3	B	1396	SR7	CAK-CAJ-NAI	2.21	126.14	122.72
2	J	1395	CNA	O2N-PN-O5D	-2.21	97.50	107.75
2	J	1395	CNA	O5B-PA-O2A	2.21	117.69	109.07
3	C	1397	SR7	CAB-CAC-CAZ	2.19	125.66	123.34
3	J	1396	SR7	CAK-CAJ-NAI	2.19	126.10	122.72
2	E	1395	CNA	O4B-C4B-C5B	2.19	116.57	109.37
2	B	1395	CNA	PN-O3-PA	-2.19	125.32	132.83
3	K	1397	SR7	CAZ-NAY-CAX	2.18	108.43	103.91
2	D	1394	CNA	C3D-C2D-C1D	2.18	105.96	102.45
2	D	1394	CNA	O5B-PA-O2A	2.18	117.58	109.07

Continued on next page...

Continued from previous page...

Mol	Chain	Res	Type	Atoms	Z	Observed(°)	Ideal(°)
3	H	1396	SR7	CBD-CBH-NAV	-2.18	107.88	113.06
3	G	1396	SR7	CAT-CAU-NAV	2.17	114.06	110.94
2	E	1395	CNA	C3N-C7N-N7N	-2.17	115.14	117.75
3	F	1396	SR7	CAN-CAM-CAP	2.17	123.48	120.44
2	L	1395	CNA	C4'-C1D-C2D	2.17	107.94	104.53
3	H	1396	SR7	CBH-NAV-CAQ	2.16	115.86	111.06
3	H	1396	SR7	CAM-CAP-CAG	2.15	123.18	120.08
2	B	1395	CNA	C4A-C5A-N7A	-2.15	107.16	109.40
3	J	1396	SR7	CAO-CAH-NAI	-2.14	115.02	118.52
3	C	1397	SR7	CAN-CAM-CAP	2.11	123.40	120.44
2	L	1395	CNA	C4A-C5A-N7A	-2.11	107.20	109.40
3	B	1396	SR7	CAD-CAC-CAZ	-2.11	114.54	119.68
3	K	1397	SR7	CBA-CAZ-CAC	-2.10	124.41	129.15
3	C	1397	SR7	CAJ-CAK-NAL	-2.10	116.97	121.51
2	D	1394	CNA	C3B-C2B-C1B	2.09	104.13	100.98
3	K	1397	SR7	CBH-NAV-CAQ	-2.09	106.40	111.06
2	C	1395	CNA	O4B-C4B-C5B	-2.07	102.55	109.37
2	E	1395	CNA	O7N-C7N-C3N	2.07	122.11	119.63
2	F	1395	CNA	C3D-C2D-C1D	-2.06	99.15	102.45
3	K	1397	SR7	CBH-CBD-CBC	2.06	132.21	129.46
3	D	1396	SR7	CAJ-NAI-CAH	2.05	119.39	116.91
2	F	1395	CNA	N6A-C6A-N1A	2.05	122.82	118.57
2	A	1395	CNA	O3D-C3D-C4D	-2.04	107.46	112.75
2	G	1395	CNA	C3B-C2B-C1B	2.04	104.05	100.98
3	C	1397	SR7	CAZ-NAY-CAX	2.04	108.13	103.91
3	I	1396	SR7	CAG-CAH-NAI	-2.03	119.06	121.00
3	I	1396	SR7	CAO-CAH-NAI	-2.03	115.19	118.52
3	K	1397	SR7	CAP-CAG-CAH	-2.03	116.73	119.25
2	D	1394	CNA	PN-O3-PA	-2.02	125.90	132.83
2	J	1395	CNA	C1B-N9A-C4A	-2.01	123.11	126.64
3	L	1397	SR7	CAP-CAG-NAL	2.00	121.75	118.69

There are no chirality outliers.

All (201) torsion outliers are listed below:

Mol	Chain	Res	Type	Atoms
2	A	1395	CNA	C4D-C5D-O5D-PN
2	A	1395	CNA	C4'-C4D-C5D-O5D
2	A	1395	CNA	C3D-C4D-C5D-O5D
2	A	1395	CNA	C2D-C1D-N1N-C2N
2	A	1395	CNA	C2D-C1D-N1N-C6N
2	B	1395	CNA	C4D-C5D-O5D-PN

Continued on next page...

Continued from previous page...

Mol	Chain	Res	Type	Atoms
2	B	1395	CNA	C2D-C1D-N1N-C2N
2	B	1395	CNA	C2D-C1D-N1N-C6N
2	C	1395	CNA	C2D-C1D-N1N-C2N
2	C	1395	CNA	C2D-C1D-N1N-C6N
2	D	1394	CNA	C2D-C1D-N1N-C2N
2	D	1394	CNA	C2D-C1D-N1N-C6N
2	E	1395	CNA	C5B-O5B-PA-O1A
2	E	1395	CNA	C5D-O5D-PN-O3
2	E	1395	CNA	C4D-C5D-O5D-PN
2	E	1395	CNA	C4'-C4D-C5D-O5D
2	E	1395	CNA	C3D-C4D-C5D-O5D
2	E	1395	CNA	C2D-C1D-N1N-C2N
2	E	1395	CNA	C2D-C1D-N1N-C6N
2	F	1395	CNA	C5D-O5D-PN-O1N
2	F	1395	CNA	C5D-O5D-PN-O2N
2	F	1395	CNA	C2D-C1D-N1N-C2N
2	F	1395	CNA	C2D-C1D-N1N-C6N
2	F	1395	CNA	C2N-C3N-C7N-O7N
2	F	1395	CNA	C2N-C3N-C7N-N7N
2	G	1395	CNA	C5B-O5B-PA-O1A
2	G	1395	CNA	C5B-O5B-PA-O2A
2	G	1395	CNA	C5B-O5B-PA-O3
2	G	1395	CNA	C5D-O5D-PN-O3
2	G	1395	CNA	C5D-O5D-PN-O1N
2	G	1395	CNA	C4'-C4D-C5D-O5D
2	G	1395	CNA	C2D-C1D-N1N-C2N
2	G	1395	CNA	C2D-C1D-N1N-C6N
2	H	1395	CNA	C5B-O5B-PA-O3
2	H	1395	CNA	C5D-O5D-PN-O3
2	H	1395	CNA	C5D-O5D-PN-O1N
2	H	1395	CNA	C4D-C5D-O5D-PN
2	H	1395	CNA	C4'-C4D-C5D-O5D
2	H	1395	CNA	C2D-C1D-N1N-C2N
2	H	1395	CNA	C2D-C1D-N1N-C6N
2	I	1395	CNA	C5D-O5D-PN-O2N
2	I	1395	CNA	C4'-C4D-C5D-O5D
2	I	1395	CNA	C3D-C4D-C5D-O5D
2	I	1395	CNA	C2D-C1D-N1N-C2N
2	I	1395	CNA	C2D-C1D-N1N-C6N
2	J	1395	CNA	C4'-C4D-C5D-O5D
2	J	1395	CNA	C3D-C4D-C5D-O5D
2	J	1395	CNA	C2D-C1D-N1N-C2N

Continued on next page...

Continued from previous page...

Mol	Chain	Res	Type	Atoms
2	J	1395	CNA	C2D-C1D-N1N-C6N
2	K	1395	CNA	C4D-C5D-O5D-PN
2	K	1395	CNA	C2D-C1D-N1N-C2N
2	K	1395	CNA	C2D-C1D-N1N-C6N
2	K	1395	CNA	C2N-C3N-C7N-O7N
2	K	1395	CNA	C2N-C3N-C7N-N7N
2	L	1395	CNA	C5D-O5D-PN-O3
2	L	1395	CNA	C4'-C4D-C5D-O5D
2	L	1395	CNA	C3D-C4D-C5D-O5D
2	L	1395	CNA	C2D-C1D-N1N-C2N
2	L	1395	CNA	C2D-C1D-N1N-C6N
2	L	1395	CNA	C2N-C3N-C7N-O7N
3	A	1396	SR7	CAJ-CAK-CBF-OBG
3	B	1396	SR7	CAJ-CAK-CBF-OBG
3	C	1397	SR7	CAJ-CAK-CBF-OBG
3	E	1396	SR7	CAJ-CAK-CBF-OBG
3	E	1396	SR7	NAW-CBD-CBH-NAV
3	E	1396	SR7	CBC-CBD-CBH-NAV
3	G	1396	SR7	CAJ-CAK-CBF-NBE
3	H	1396	SR7	CAJ-CAK-CBF-NBE
3	H	1396	SR7	CAJ-CAK-CBF-OBG
3	H	1396	SR7	NAL-CAK-CBF-NBE
3	I	1396	SR7	CAJ-CAK-CBF-NBE
3	I	1396	SR7	CAJ-CAK-CBF-OBG
3	K	1397	SR7	CAJ-CAK-CBF-NBE
3	K	1397	SR7	CAJ-CAK-CBF-OBG
3	L	1397	SR7	CAB-CAC-CAZ-CBA
3	L	1397	SR7	CAJ-CAK-CBF-NBE
3	L	1397	SR7	CAJ-CAK-CBF-OBG
3	L	1397	SR7	NAW-CBD-CBH-NAV
3	L	1397	SR7	CBC-CBD-CBH-NAV
3	E	1396	SR7	NAL-CAK-CBF-OBG
3	H	1396	SR7	NAL-CAK-CBF-OBG
3	K	1397	SR7	NAL-CAK-CBF-OBG
3	L	1397	SR7	NAL-CAK-CBF-OBG
3	E	1396	SR7	NAL-CAK-CBF-NBE
3	G	1396	SR7	NAL-CAK-CBF-NBE
3	I	1396	SR7	NAL-CAK-CBF-NBE
3	K	1397	SR7	NAL-CAK-CBF-NBE
3	L	1397	SR7	NAL-CAK-CBF-NBE
2	K	1395	CNA	C4N-C3N-C7N-O7N
2	K	1395	CNA	C4N-C3N-C7N-N7N

Continued on next page...

Continued from previous page...

Mol	Chain	Res	Type	Atoms
3	A	1396	SR7	NAL-CAK-CBF-OBG
3	B	1396	SR7	NAL-CAK-CBF-OBG
3	C	1397	SR7	NAL-CAK-CBF-OBG
3	G	1396	SR7	NAL-CAK-CBF-OBG
3	I	1396	SR7	NAL-CAK-CBF-OBG
3	J	1396	SR7	NAL-CAK-CBF-OBG
3	F	1396	SR7	NAL-CAK-CBF-OBG
3	C	1397	SR7	NAL-CAK-CBF-NBE
3	J	1396	SR7	NAL-CAK-CBF-NBE
2	E	1395	CNA	C2N-C3N-C7N-N7N
3	A	1396	SR7	NAL-CAK-CBF-NBE
3	B	1396	SR7	NAL-CAK-CBF-NBE
2	F	1395	CNA	C4N-C3N-C7N-N7N
3	F	1396	SR7	NAL-CAK-CBF-NBE
2	E	1395	CNA	O4B-C4B-C5B-O5B
2	H	1395	CNA	O4B-C4B-C5B-O5B
2	E	1395	CNA	C4N-C3N-C7N-N7N
2	F	1395	CNA	C4N-C3N-C7N-O7N
2	E	1395	CNA	C2N-C3N-C7N-O7N
2	L	1395	CNA	C2N-C3N-C7N-N7N
2	L	1395	CNA	C4N-C3N-C7N-O7N
3	F	1396	SR7	CAJ-CAK-CBF-OBG
3	G	1396	SR7	CAJ-CAK-CBF-OBG
3	J	1396	SR7	CAJ-CAK-CBF-OBG
2	E	1395	CNA	C4N-C3N-C7N-O7N
2	L	1395	CNA	C4N-C3N-C7N-N7N
2	E	1395	CNA	C3B-C4B-C5B-O5B
3	A	1396	SR7	CAJ-CAK-CBF-NBE
3	B	1396	SR7	CAJ-CAK-CBF-NBE
3	C	1397	SR7	CAJ-CAK-CBF-NBE
3	E	1396	SR7	CAJ-CAK-CBF-NBE
3	F	1396	SR7	CAJ-CAK-CBF-NBE
3	J	1396	SR7	CAJ-CAK-CBF-NBE
2	J	1395	CNA	C2N-C3N-C7N-N7N
5	C	1396	GOL	C1-C2-C3-O3
2	J	1395	CNA	C2N-C3N-C7N-O7N
2	J	1395	CNA	C4N-C3N-C7N-N7N
3	D	1396	SR7	CBC-CBD-CBH-NAV
2	H	1395	CNA	C4B-C5B-O5B-PA
2	D	1394	CNA	O4B-C4B-C5B-O5B
2	D	1394	CNA	C4D-C5D-O5D-PN
2	F	1395	CNA	C4D-C5D-O5D-PN

Continued on next page...

Continued from previous page...

Mol	Chain	Res	Type	Atoms
2	I	1395	CNA	C5D-O5D-PN-O3
5	C	1396	GOL	O2-C2-C3-O3
5	D	1395	GOL	O1-C1-C2-O2
5	K	1396	GOL	O1-C1-C2-O2
5	L	1396	GOL	O2-C2-C3-O3
2	F	1395	CNA	C3D-C4D-C5D-O5D
2	H	1395	CNA	C3D-C4D-C5D-O5D
2	L	1395	CNA	PA-O3-PN-O1N
2	J	1395	CNA	C4N-C3N-C7N-O7N
2	E	1395	CNA	C5B-O5B-PA-O2A
2	H	1395	CNA	C5B-O5B-PA-O1A
2	H	1395	CNA	C5B-O5B-PA-O2A
2	I	1395	CNA	C5D-O5D-PN-O1N
2	L	1395	CNA	C5D-O5D-PN-O1N
2	L	1395	CNA	C5D-O5D-PN-O2N
2	G	1395	CNA	C2N-C3N-C7N-O7N
5	D	1395	GOL	O2-C2-C3-O3
2	G	1395	CNA	C2N-C3N-C7N-N7N
2	G	1395	CNA	C4N-C3N-C7N-O7N
2	B	1395	CNA	C4N-C3N-C7N-N7N
2	I	1395	CNA	C2N-C3N-C7N-N7N
2	F	1395	CNA	O4B-C4B-C5B-O5B
2	G	1395	CNA	O4B-C4B-C5B-O5B
2	H	1395	CNA	C3B-C4B-C5B-O5B
2	K	1395	CNA	O4B-C4B-C5B-O5B
3	A	1396	SR7	CBC-CBD-CBH-NAV
3	B	1396	SR7	CBC-CBD-CBH-NAV
3	C	1397	SR7	CBC-CBD-CBH-NAV
3	F	1396	SR7	CBC-CBD-CBH-NAV
3	G	1396	SR7	CBC-CBD-CBH-NAV
3	H	1396	SR7	CBC-CBD-CBH-NAV
3	J	1396	SR7	CBC-CBD-CBH-NAV
2	I	1395	CNA	C2N-C3N-C7N-O7N
2	K	1395	CNA	PA-O3-PN-O2N
2	G	1395	CNA	C4N-C3N-C7N-N7N
2	F	1395	CNA	C3B-C4B-C5B-O5B
2	I	1395	CNA	C4N-C3N-C7N-N7N
2	B	1395	CNA	O4B-C4B-C5B-O5B
2	H	1395	CNA	C2N-C3N-C7N-N7N
2	C	1395	CNA	C4D-C5D-O5D-PN
2	F	1395	CNA	C5D-O5D-PN-O3
2	G	1395	CNA	C4D-C5D-O5D-PN

Continued on next page...

Continued from previous page...

Mol	Chain	Res	Type	Atoms
2	J	1395	CNA	C4D-C5D-O5D-PN
2	L	1395	CNA	O4B-C4B-C5B-O5B
2	G	1395	CNA	C3D-C4D-C5D-O5D
2	I	1395	CNA	PA-O3-PN-O1N
2	I	1395	CNA	PA-O3-PN-O2N
2	K	1395	CNA	PA-O3-PN-O1N
2	K	1395	CNA	C3D-C4D-C5D-O5D
2	L	1395	CNA	PA-O3-PN-O2N
2	H	1395	CNA	C2N-C3N-C7N-O7N
5	D	1395	GOL	O1-C1-C2-C3
5	D	1395	GOL	C1-C2-C3-O3
5	K	1396	GOL	O1-C1-C2-C3
3	A	1396	SR7	CAB-CAC-CAZ-CBA
3	K	1397	SR7	CAB-CAC-CAZ-CBA
2	B	1395	CNA	C2N-C3N-C7N-N7N
2	A	1395	CNA	O4B-C4B-C5B-O5B
2	C	1395	CNA	O4B-C4B-C5B-O5B
2	J	1395	CNA	O4B-C4B-C5B-O5B
3	B	1396	SR7	NAW-CBD-CBH-NAV
3	C	1397	SR7	NAW-CBD-CBH-NAV
3	D	1396	SR7	NAW-CBD-CBH-NAV
3	F	1396	SR7	NAW-CBD-CBH-NAV
3	G	1396	SR7	NAW-CBD-CBH-NAV
3	H	1396	SR7	NAW-CBD-CBH-NAV
3	I	1396	SR7	NAW-CBD-CBH-NAV
3	J	1396	SR7	NAW-CBD-CBH-NAV
3	K	1397	SR7	NAW-CBD-CBH-NAV

All (8) ring outliers are listed below:

Mol	Chain	Res	Type	Atoms
3	E	1396	SR7	CAQ-CAR-CAT-CAU-NAS-NAV
3	L	1397	SR7	CAQ-CAR-CAT-CAU-NAS-NAV
3	D	1396	SR7	CAQ-CAR-CAT-CAU-NAS-NAV
3	G	1396	SR7	CAQ-CAR-CAT-CAU-NAS-NAV
3	B	1396	SR7	CAQ-CAR-CAT-CAU-NAS-NAV
3	A	1396	SR7	CAQ-CAR-CAT-CAU-NAS-NAV
3	F	1396	SR7	CAQ-CAR-CAT-CAU-NAS-NAV
3	J	1396	SR7	CAQ-CAR-CAT-CAU-NAS-NAV

27 monomers are involved in 126 short contacts:

Mol	Chain	Res	Type	Clashes	Symm-Clashes
3	F	1396	SR7	11	0
2	F	1395	CNA	3	0
3	E	1396	SR7	5	0
2	E	1395	CNA	1	0
2	A	1395	CNA	5	0
3	L	1397	SR7	6	0
3	A	1396	SR7	4	0
3	G	1396	SR7	18	0
2	I	1395	CNA	5	0
2	C	1395	CNA	1	0
3	C	1397	SR7	4	0
3	J	1396	SR7	7	0
2	J	1395	CNA	4	0
3	K	1397	SR7	8	0
5	C	1396	GOL	2	0
3	I	1396	SR7	10	0
5	D	1395	GOL	3	0
2	B	1395	CNA	4	0
2	D	1394	CNA	5	0
3	H	1396	SR7	12	0
2	K	1395	CNA	6	0
2	H	1395	CNA	11	0
3	D	1396	SR7	2	0
5	K	1396	GOL	1	0
2	L	1395	CNA	5	0
2	G	1395	CNA	12	0
3	B	1396	SR7	5	0

The following is a two-dimensional graphical depiction of Mogul quality analysis of bond lengths, bond angles, torsion angles, and ring geometry for all instances of the Ligand of Interest. In addition, ligands with molecular weight > 250 and outliers as shown on the validation Tables will also be included. For torsion angles, if less than 5% of the Mogul distribution of torsion angles is within 10 degrees of the torsion angle in question, then that torsion angle is considered an outlier. Any bond that is central to one or more torsion angles identified as an outlier by Mogul will be highlighted in the graph. For rings, the root-mean-square deviation (RMSD) between the ring in question and similar rings identified by Mogul is calculated over all ring torsion angles. If the average RMSD is greater than 60 degrees and the minimal RMSD between the ring in question and any Mogul-identified rings is also greater than 60 degrees, then that ring is considered an outlier. The outliers are highlighted in purple. The color gray indicates Mogul did not find sufficient equivalents in the CSD to analyse the geometry.

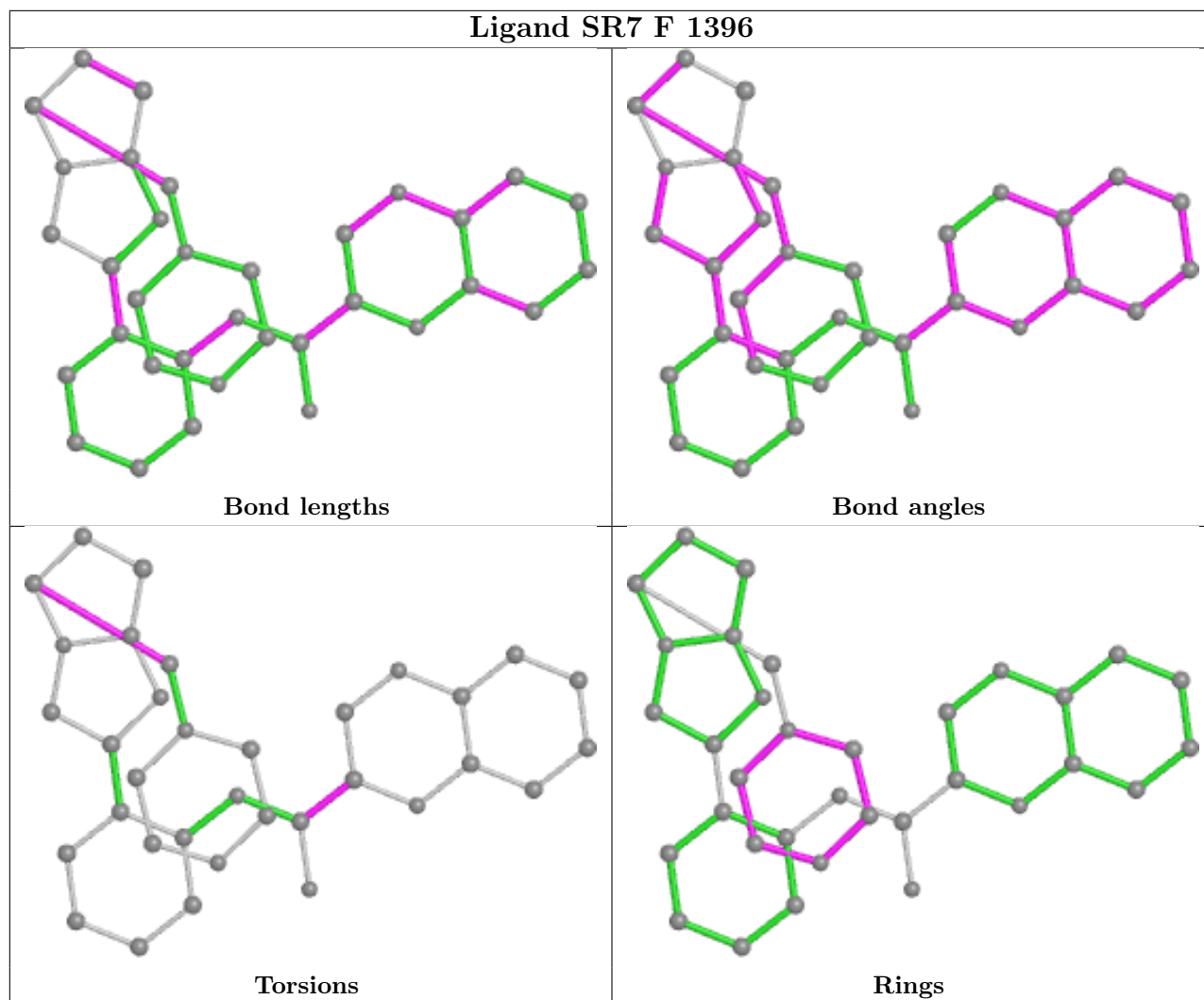

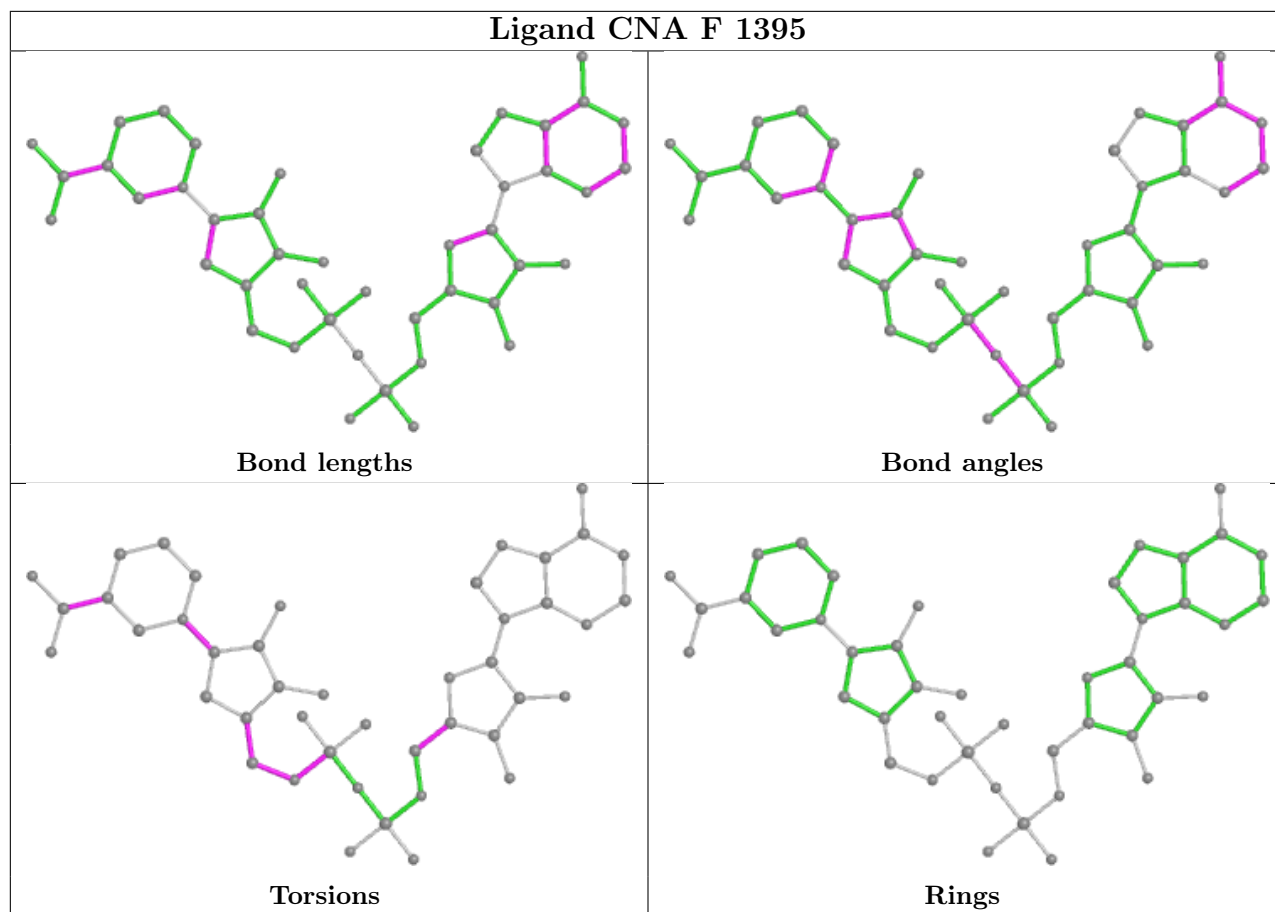

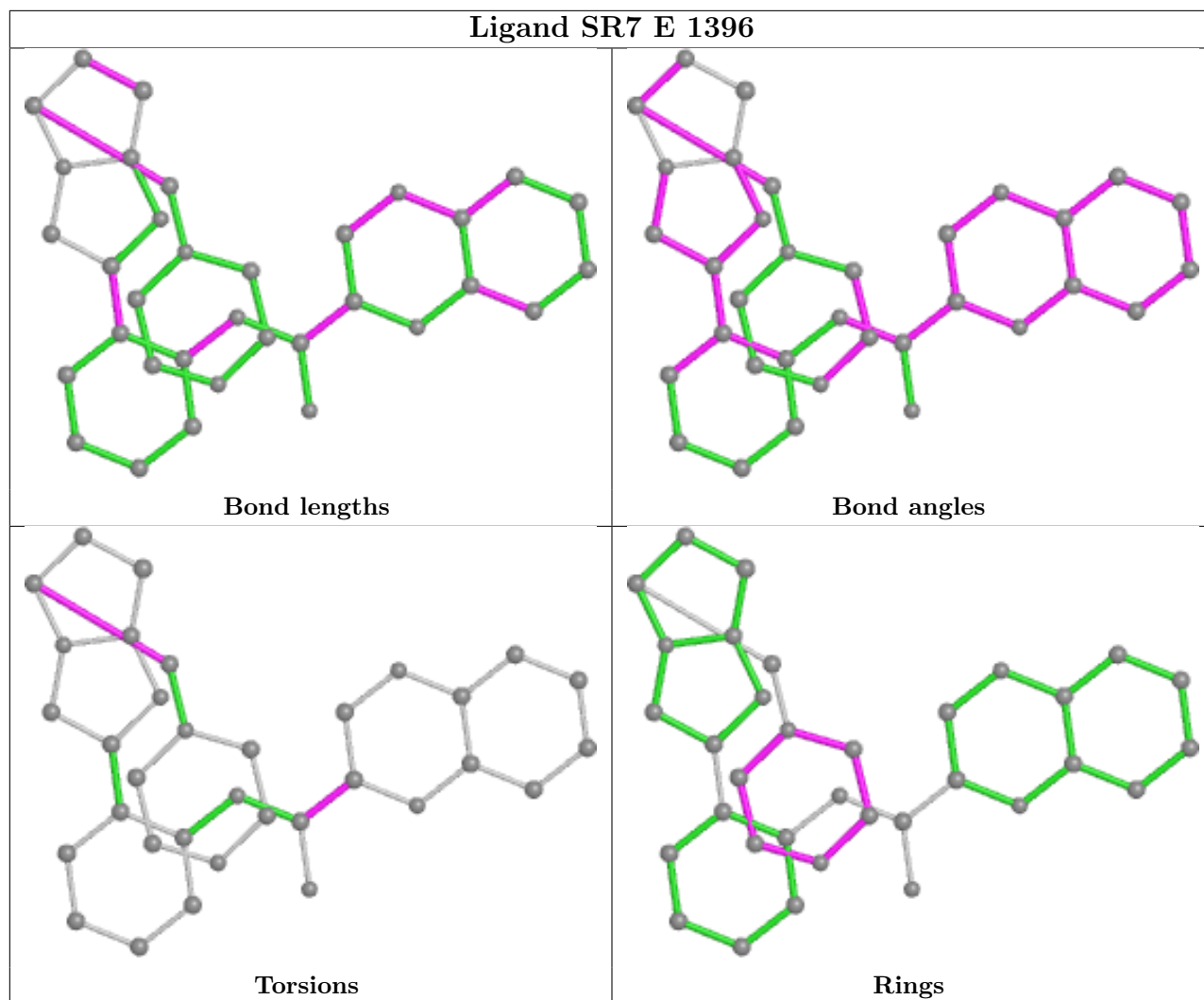

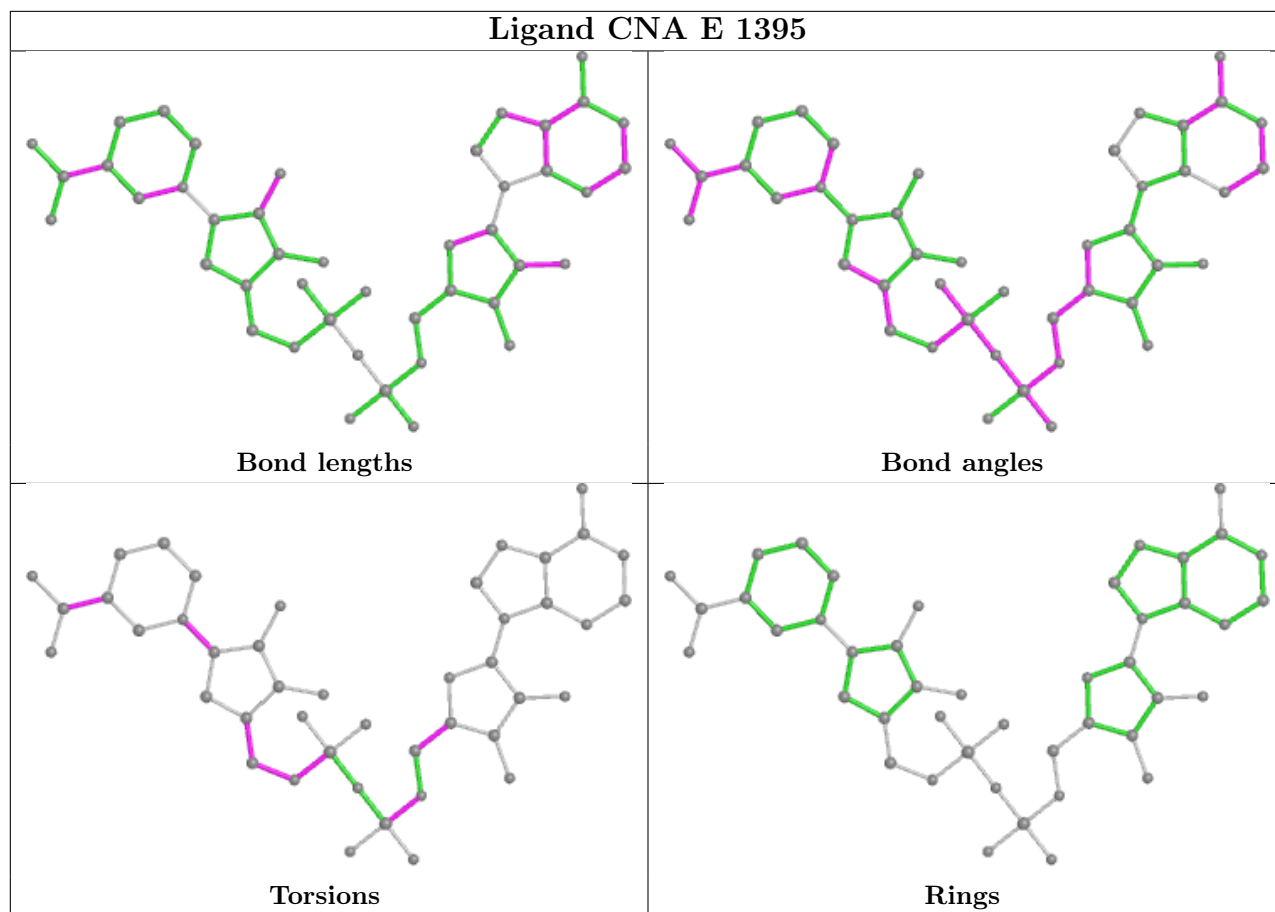

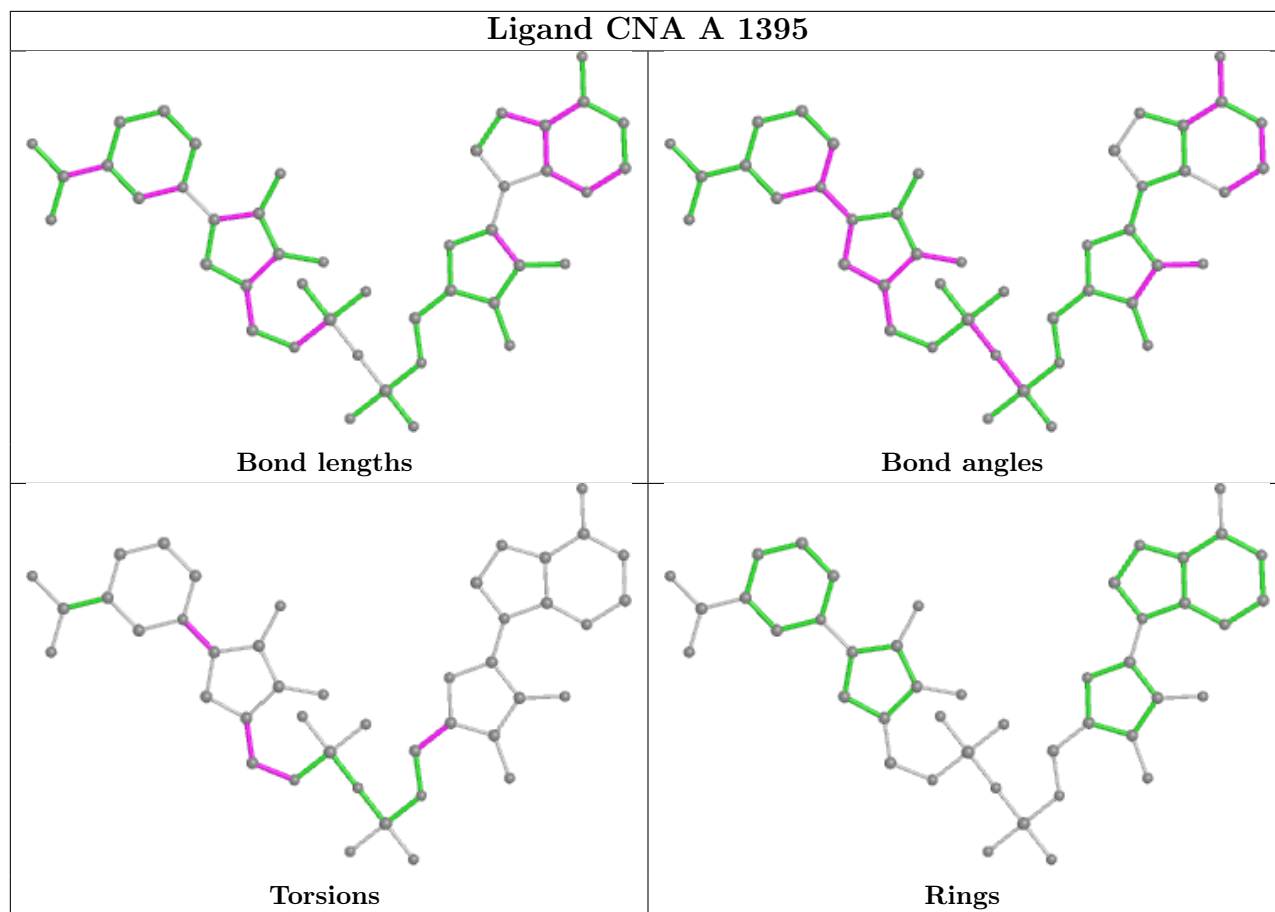

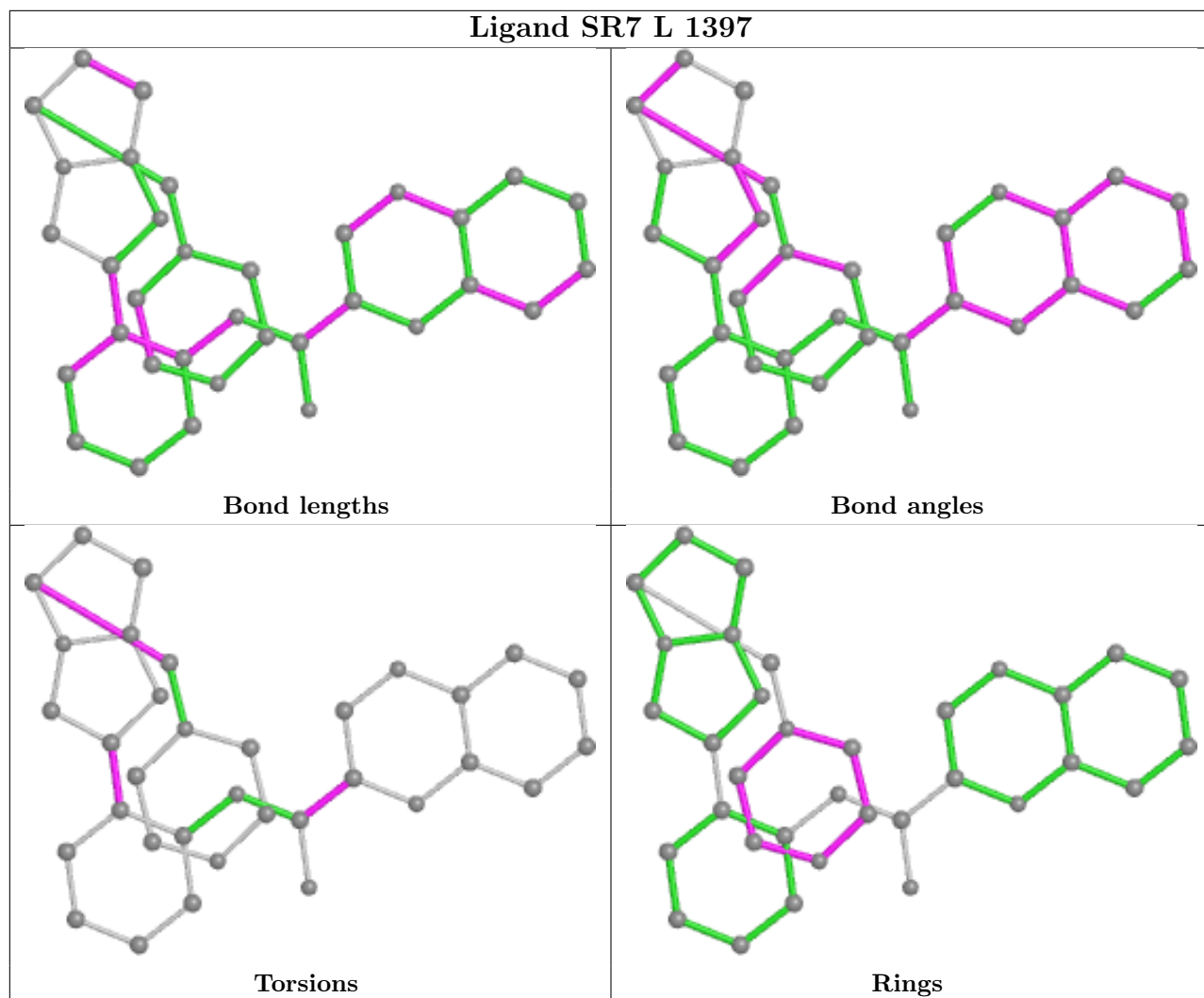

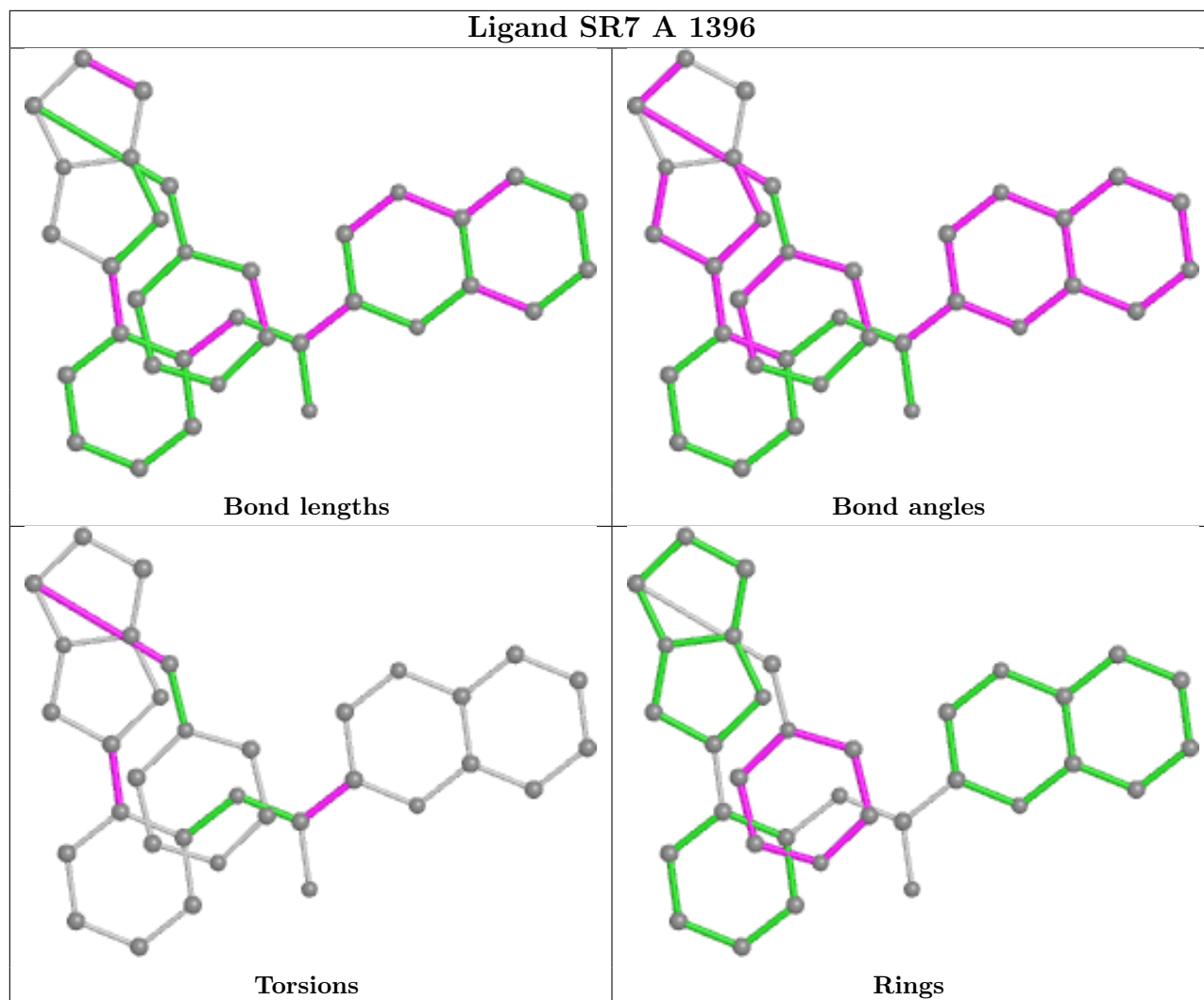

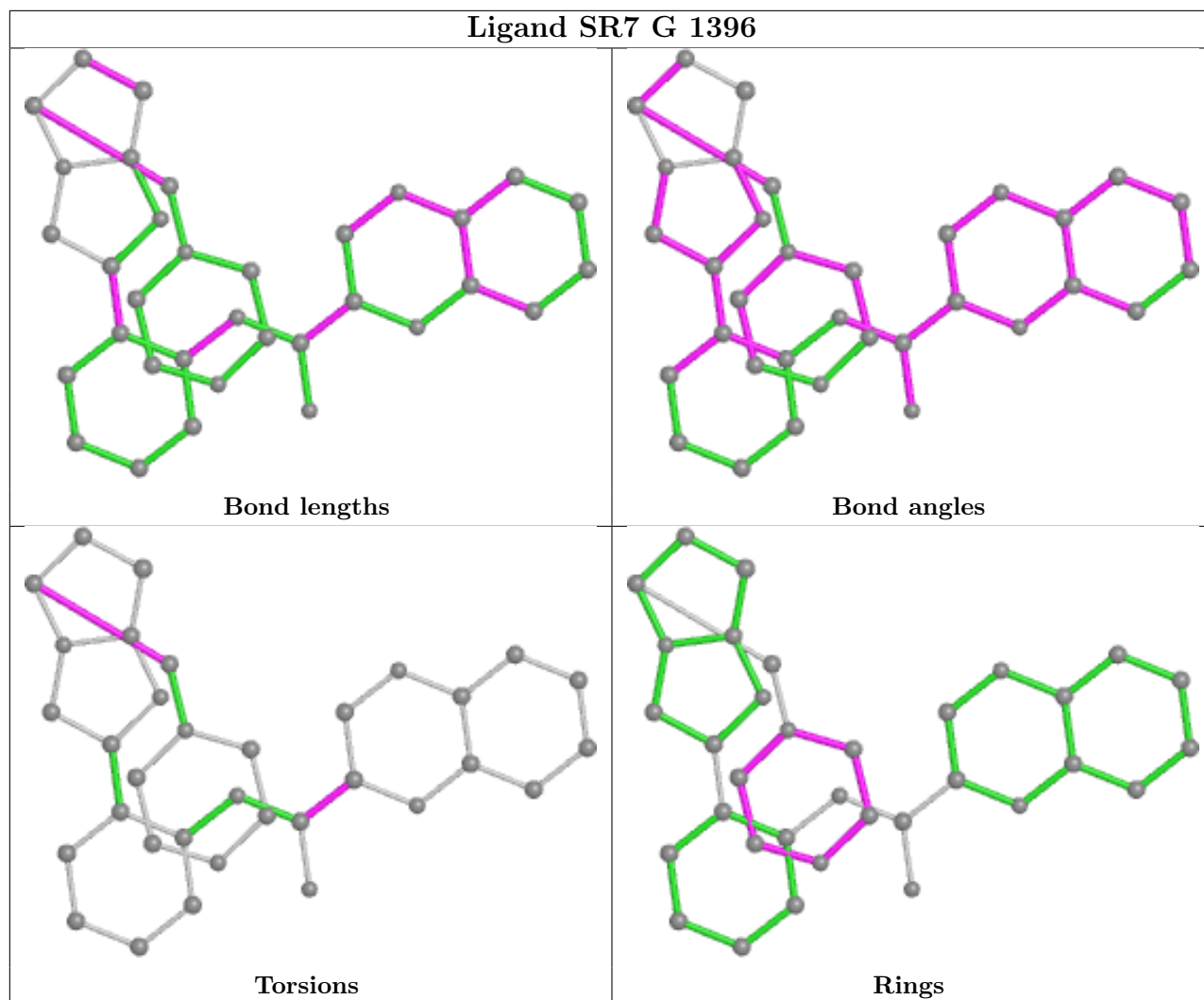

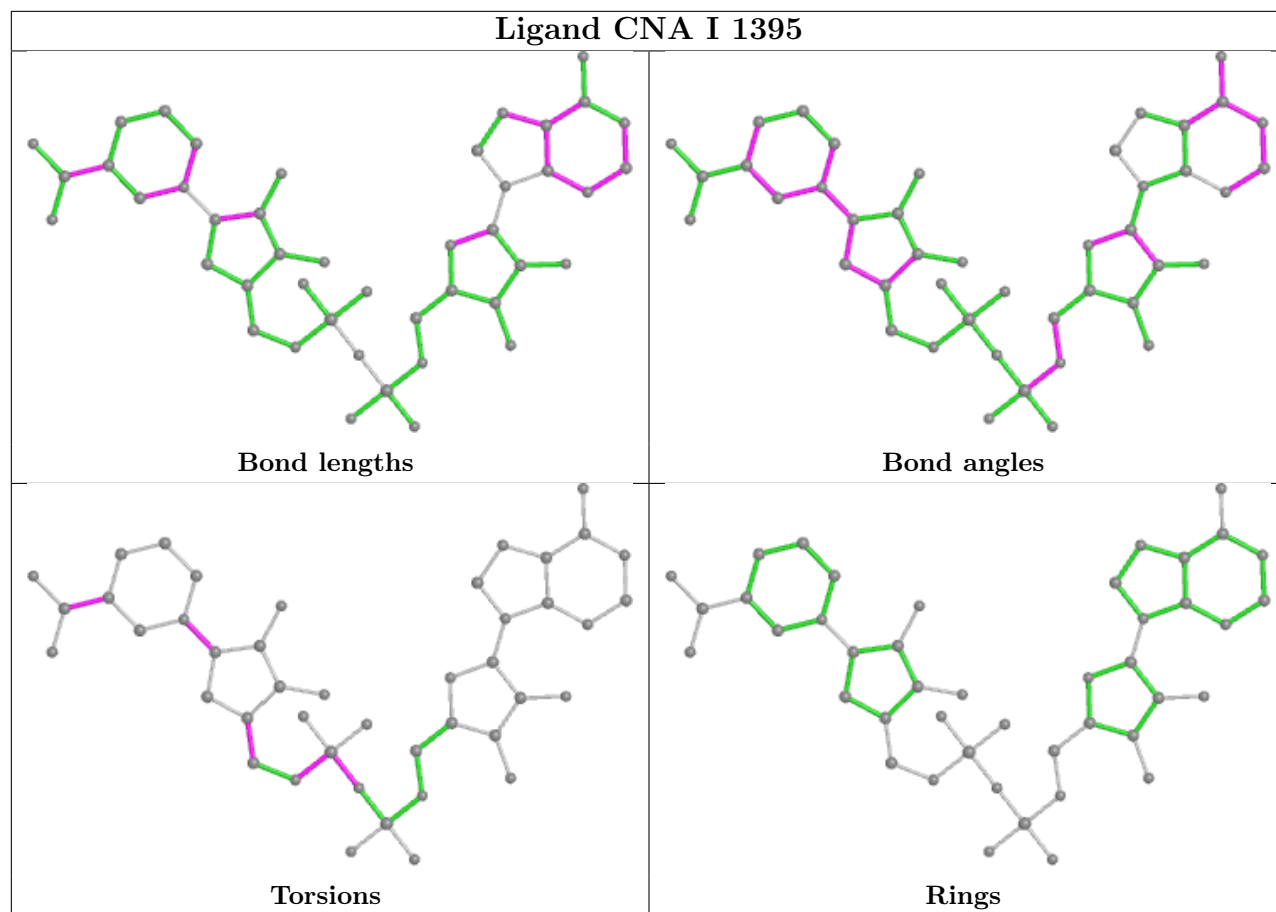

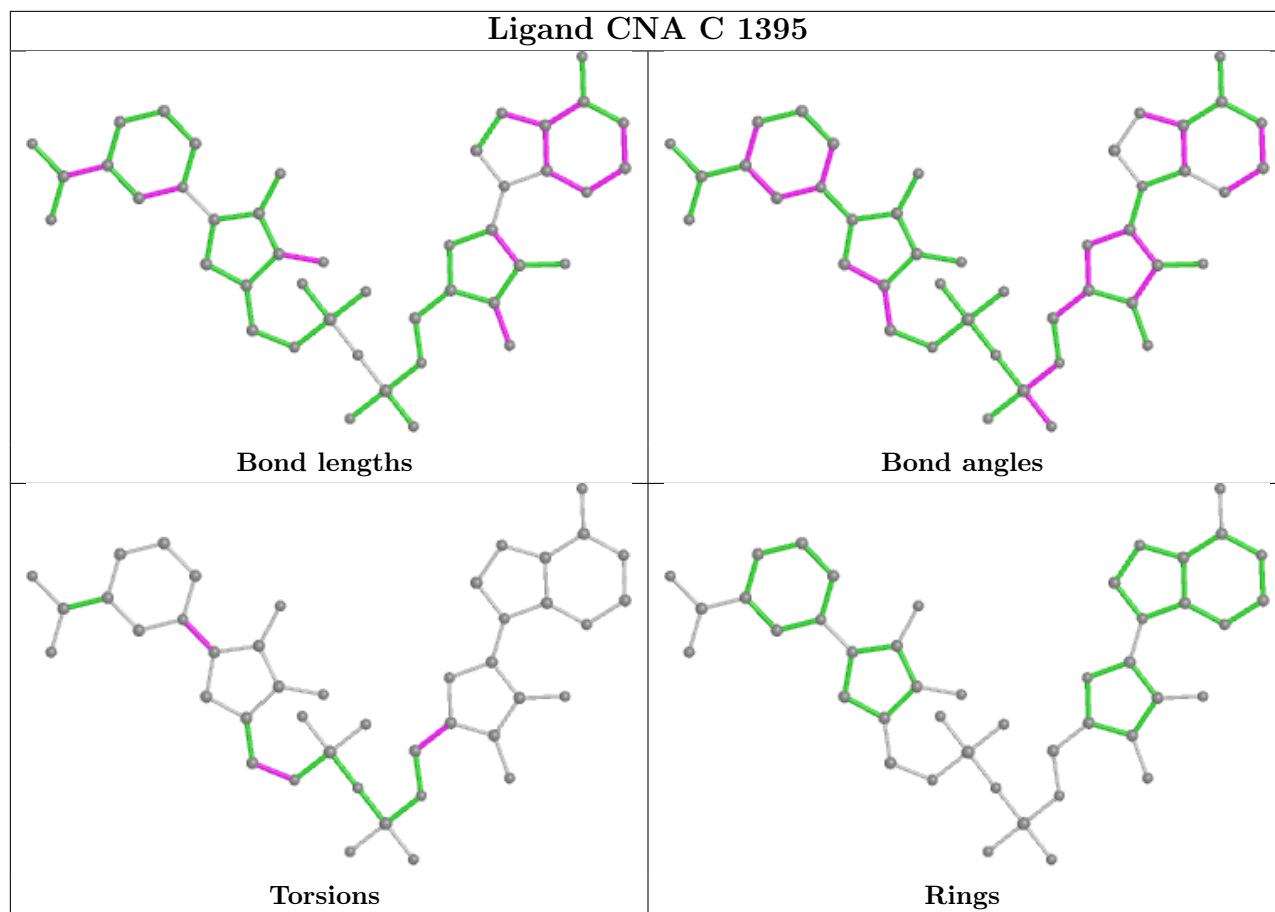

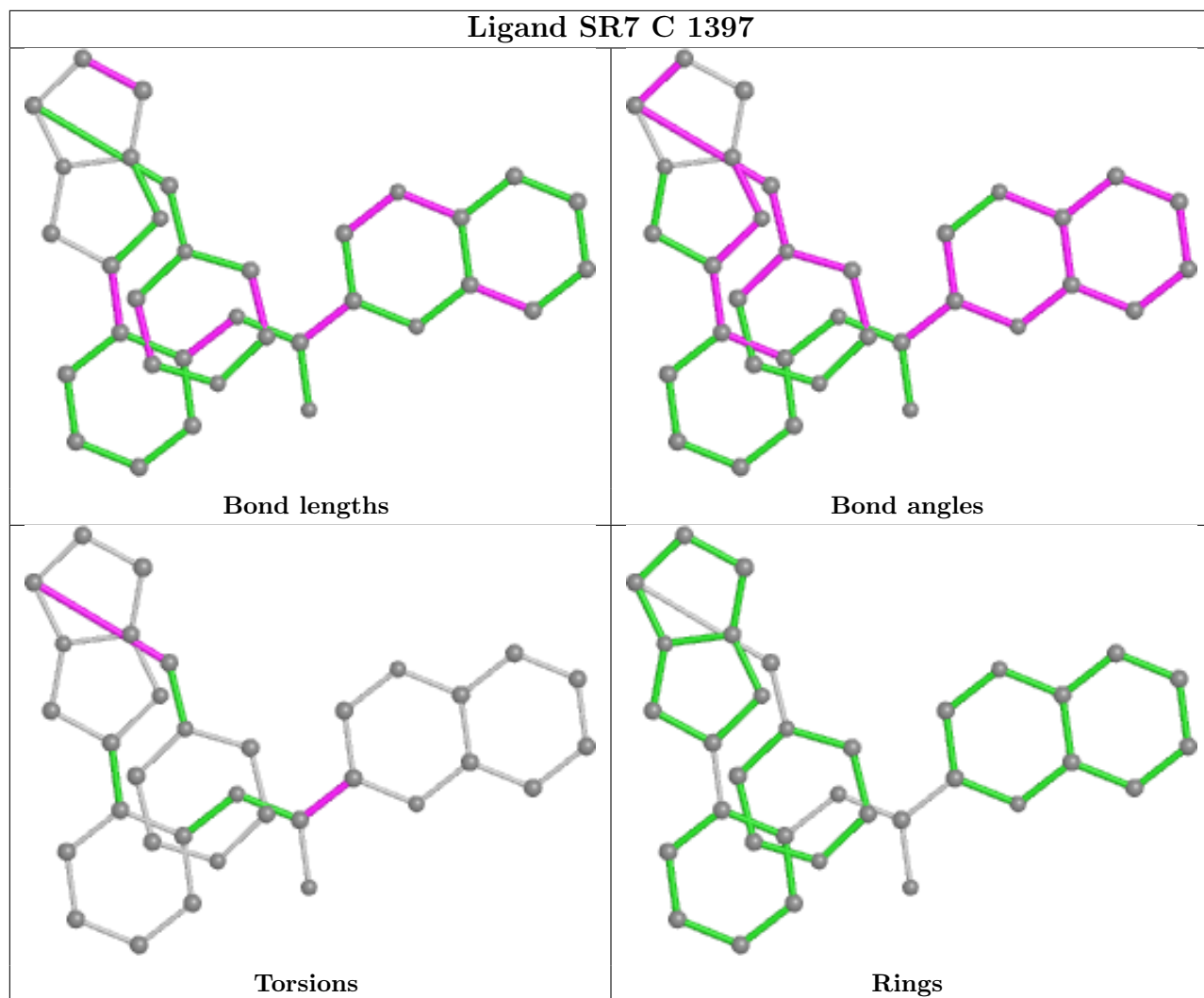

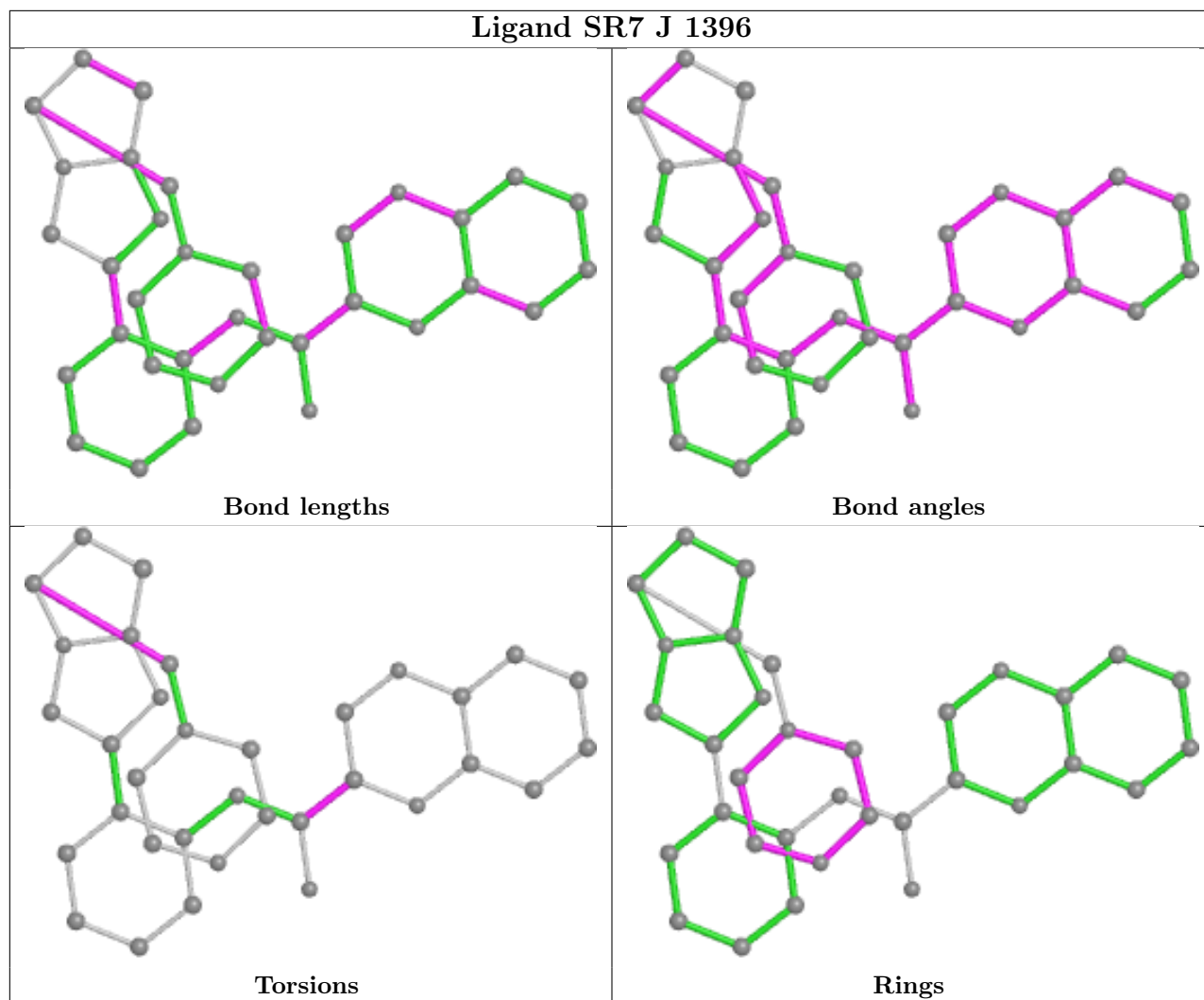

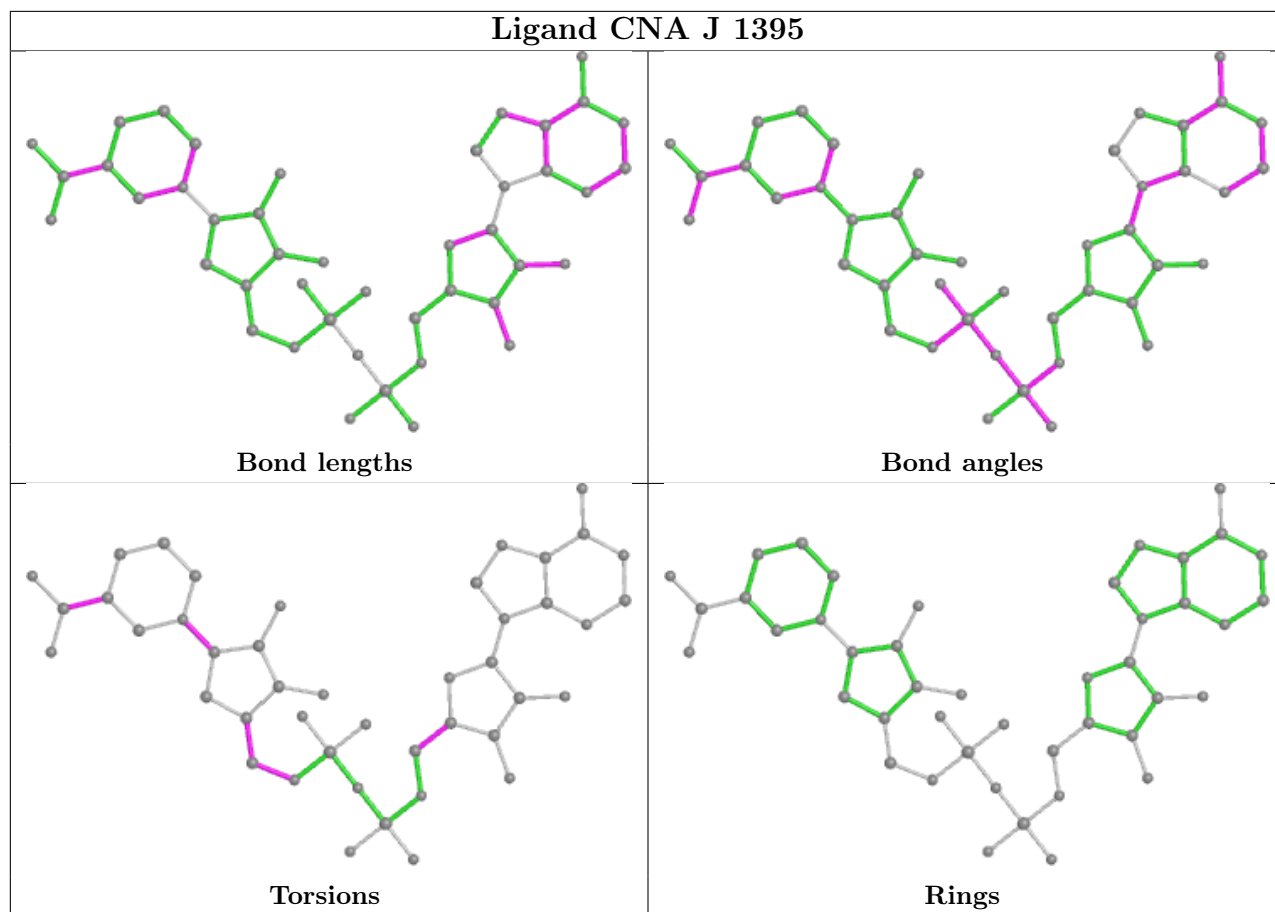

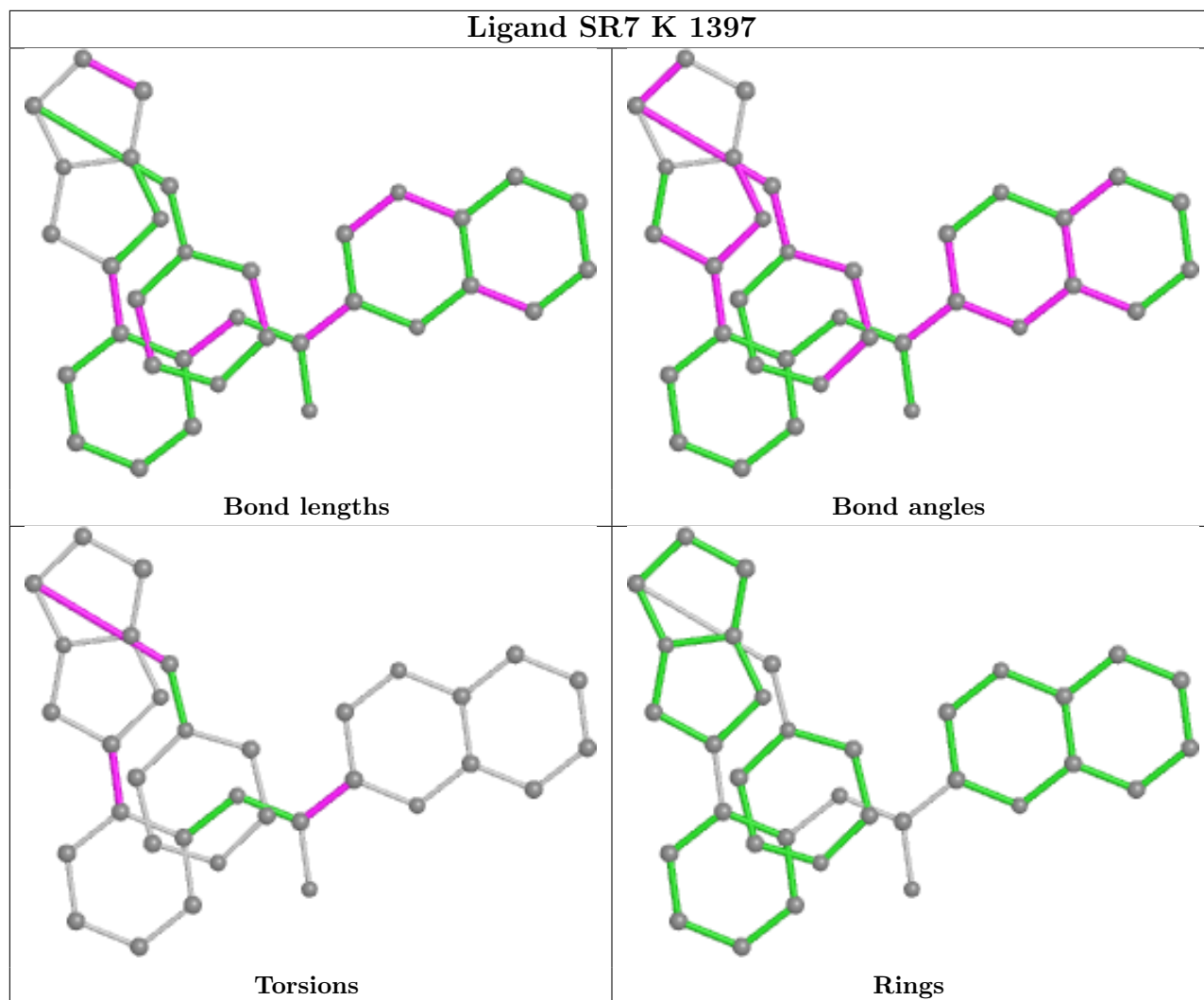

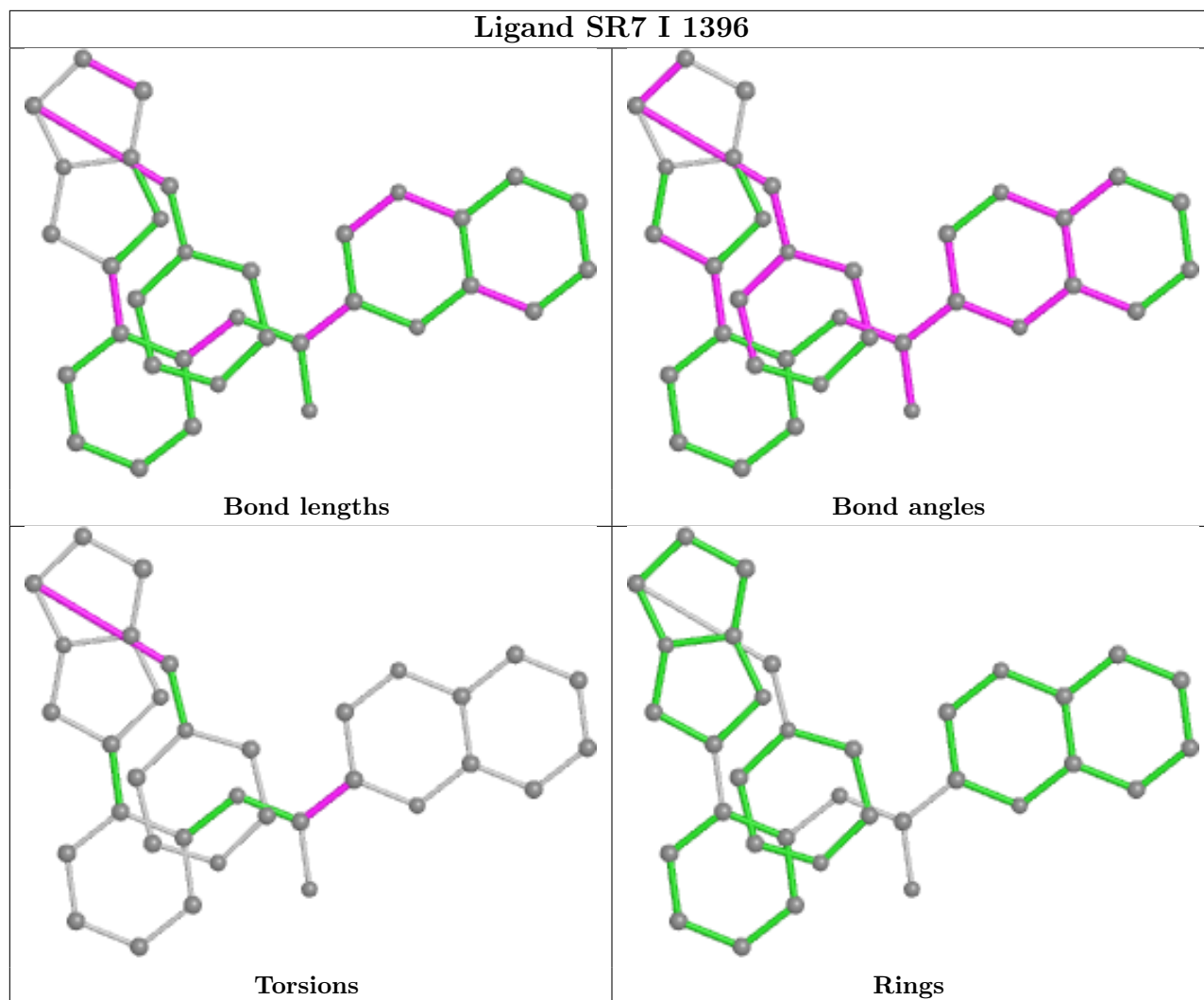

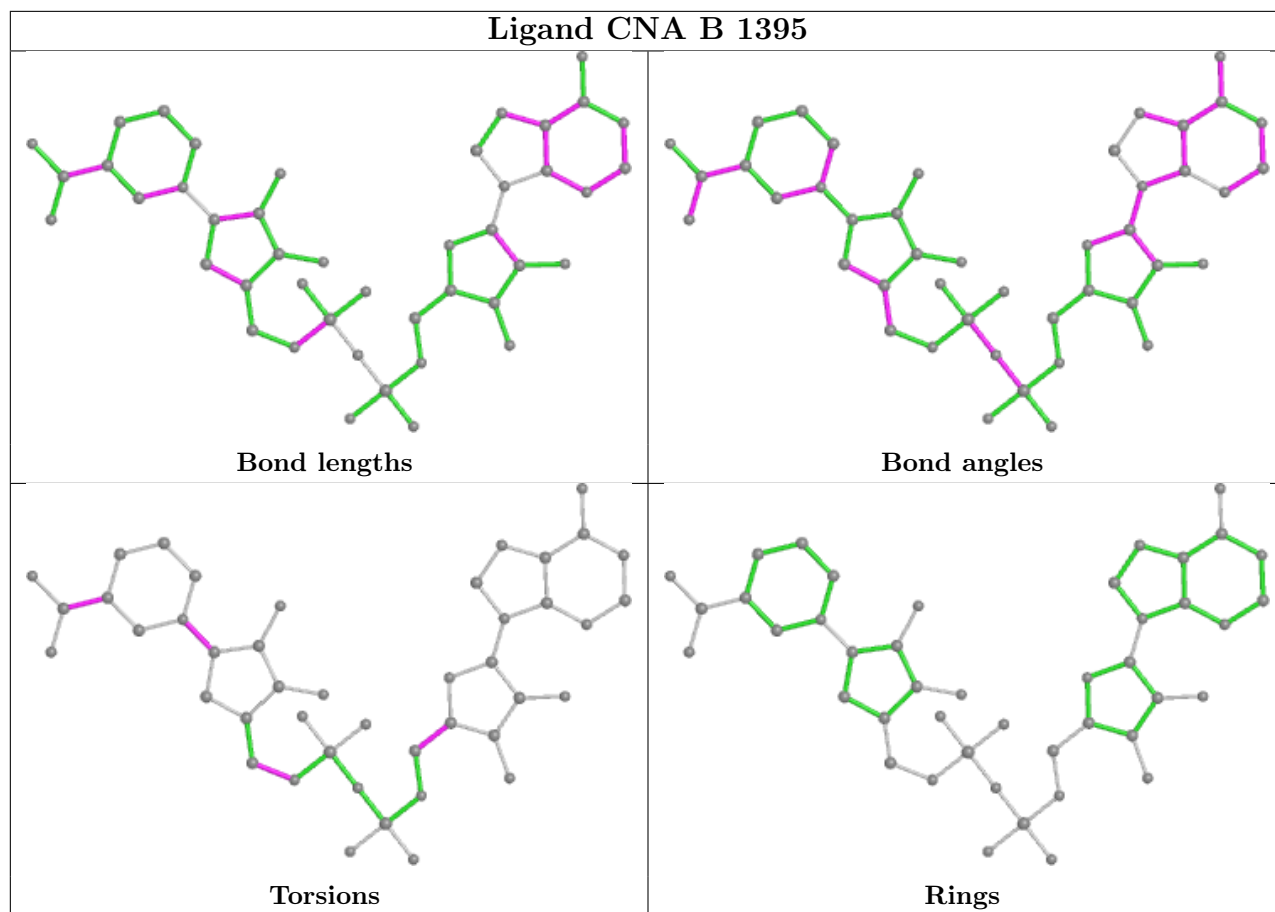

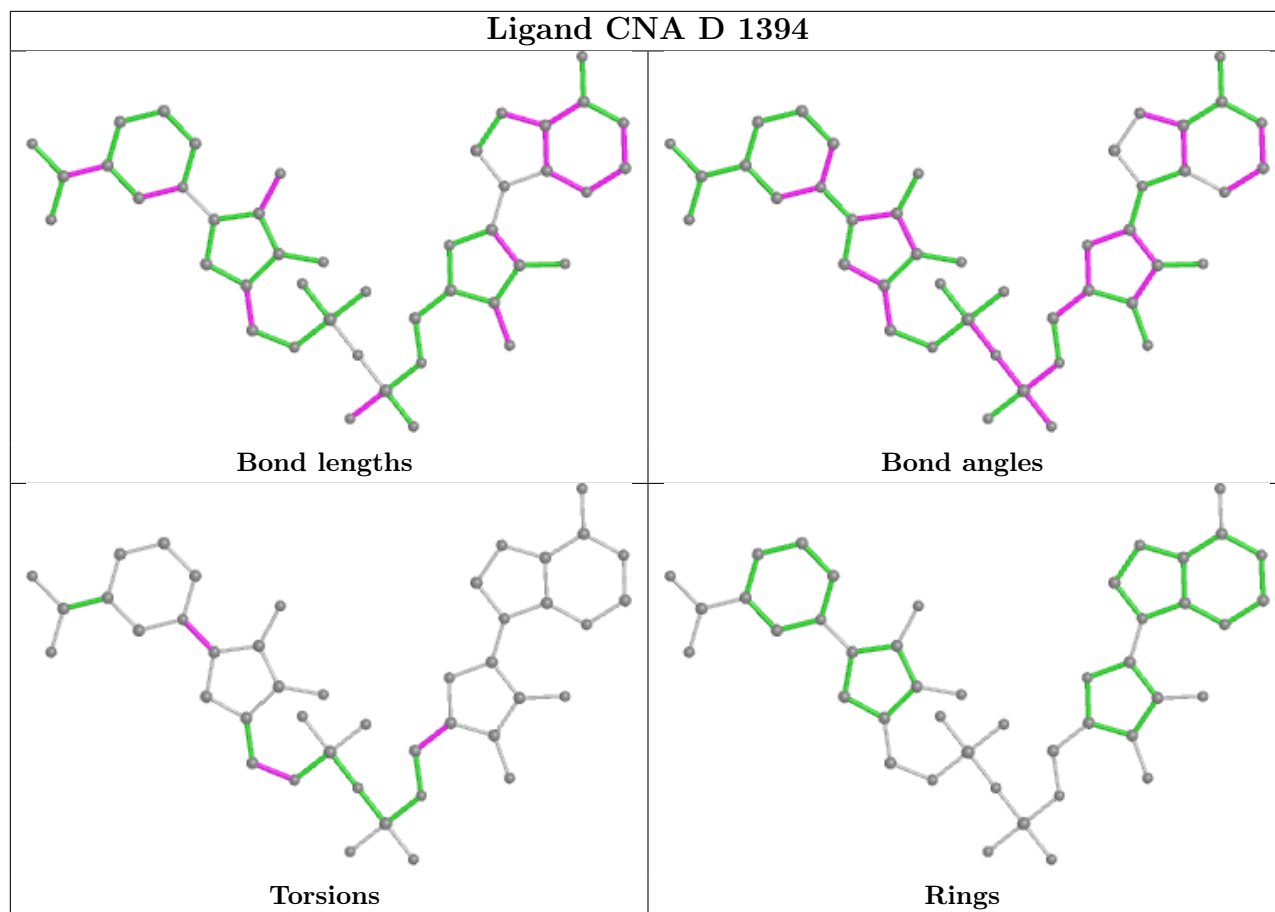

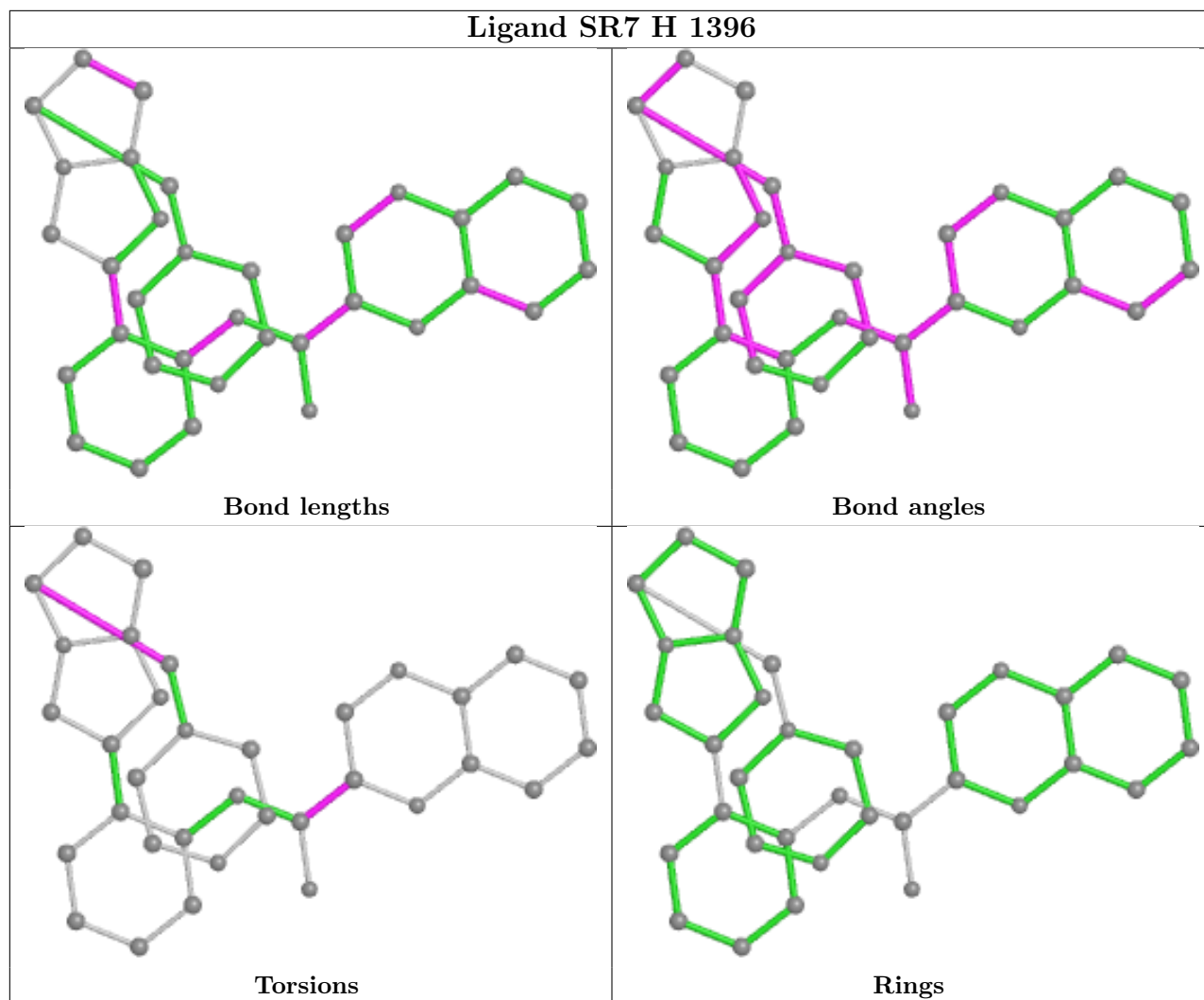

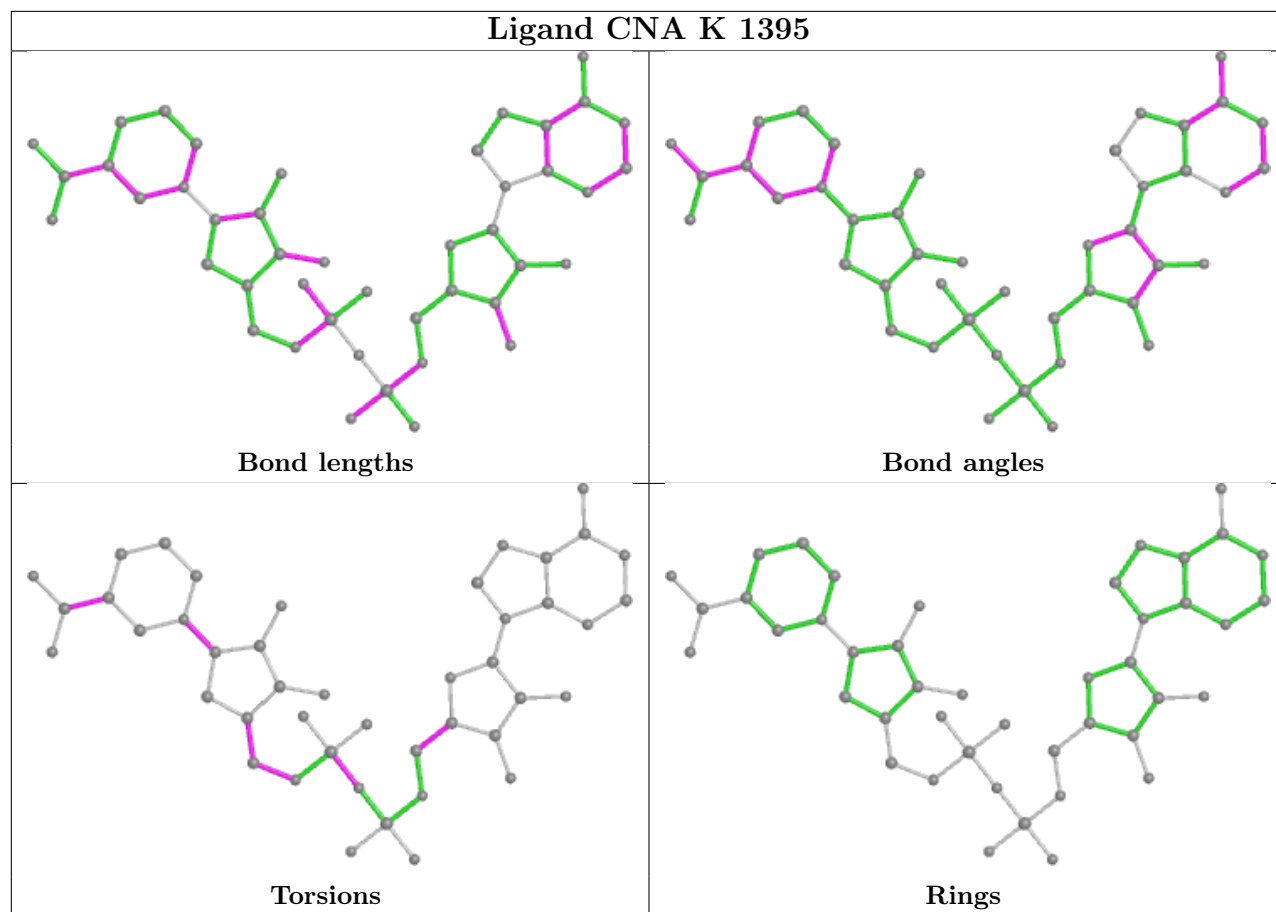

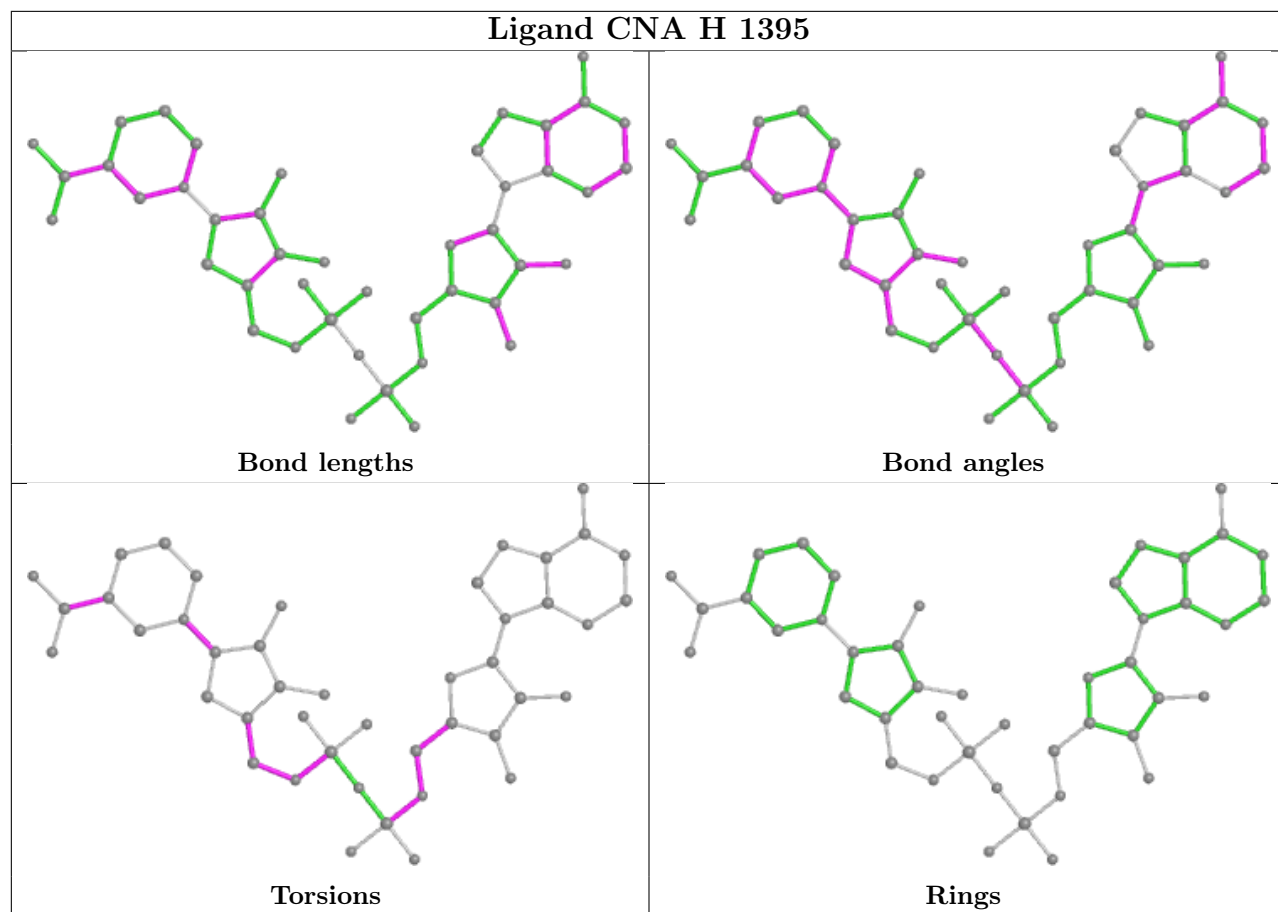

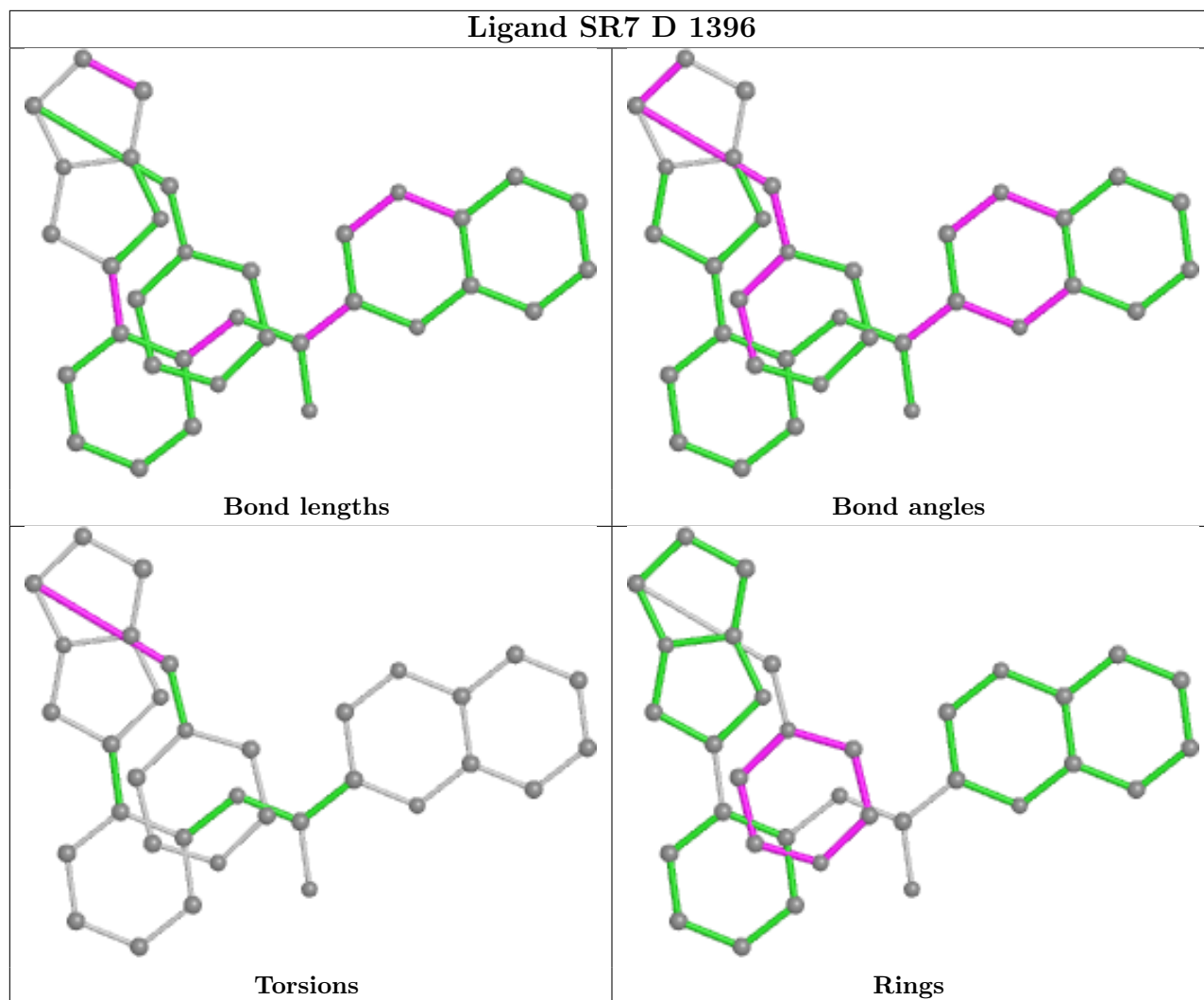

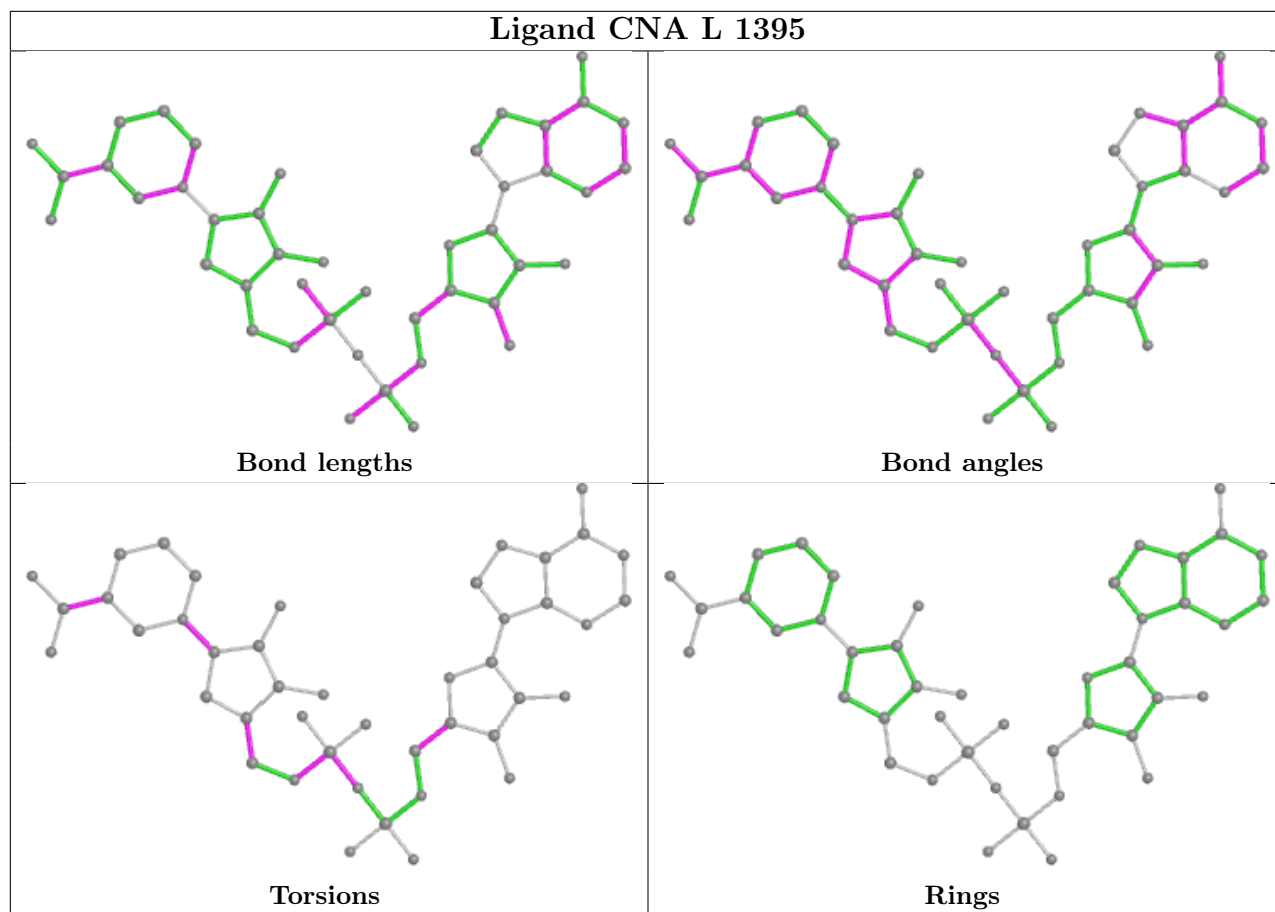

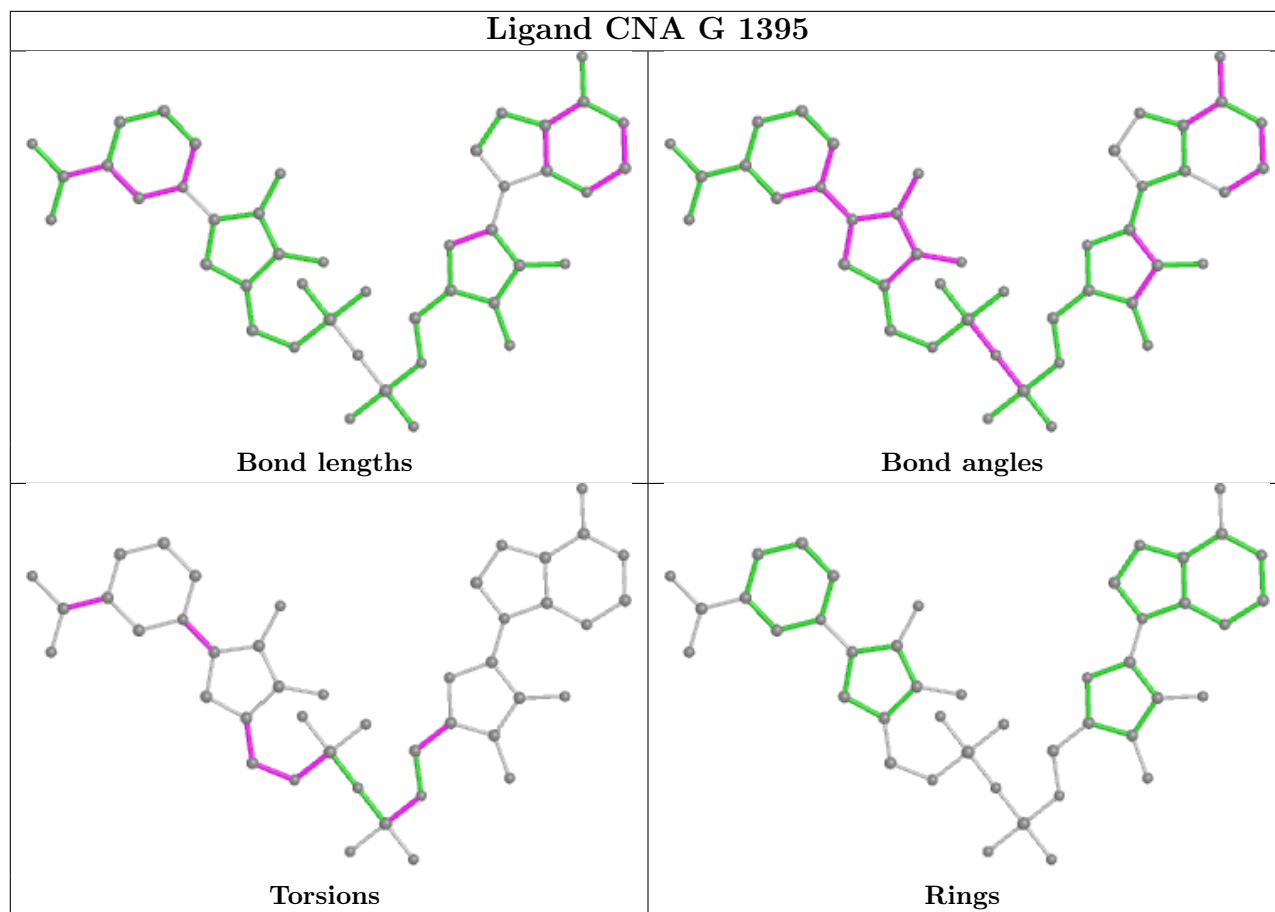

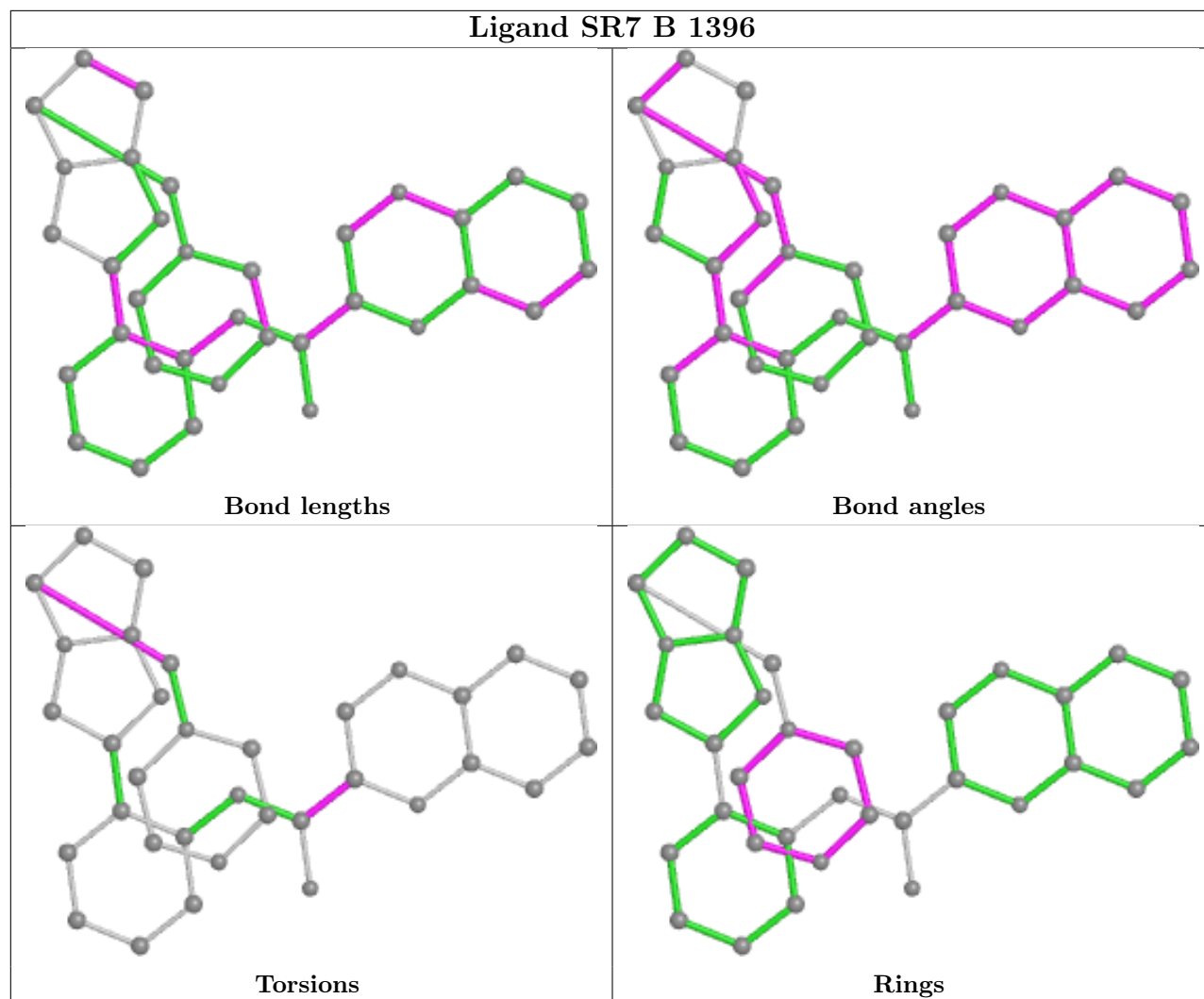

5.7 Other polymers [i](#)

There are no such residues in this entry.

5.8 Polymer linkage issues [i](#)

There are no chain breaks in this entry.

6 Fit of model and data i

6.1 Protein, DNA and RNA chains i

In the following table, the column labelled ‘#RSRZ > 2’ contains the number (and percentage) of RSRZ outliers, followed by percent RSRZ outliers for the chain as percentile scores relative to all X-ray entries and entries of similar resolution. The OWAB column contains the minimum, median, 95th percentile and maximum values of the occupancy-weighted average B-factor per residue. The column labelled ‘Q < 0.9’ lists the number of (and percentage) of residues with an average occupancy less than 0.9.

Mol	Chain	Analysed	<RSRZ>	#RSRZ>2	OWAB(Å ²)	Q<0.9
1	A	273/281 (97%)	-0.10	0 100 100	56, 84, 116, 135	0
1	B	273/281 (97%)	-0.08	0 100 100	56, 81, 114, 133	0
1	C	273/281 (97%)	-0.09	0 100 100	62, 96, 131, 153	0
1	D	272/281 (96%)	-0.08	1 (0%) 92 92	64, 98, 132, 144	0
1	E	273/281 (97%)	-0.22	0 100 100	64, 87, 112, 123	0
1	F	273/281 (97%)	-0.20	1 (0%) 92 92	69, 92, 125, 139	0
1	G	273/281 (97%)	-0.18	0 100 100	66, 87, 110, 124	0
1	H	273/281 (97%)	-0.21	0 100 100	75, 101, 127, 141	0
1	I	273/281 (97%)	-0.17	0 100 100	73, 99, 127, 138	0
1	J	273/281 (97%)	-0.16	1 (0%) 92 92	68, 91, 123, 136	0
1	K	273/281 (97%)	0.05	6 (2%) 62 59	101, 132, 166, 177	0
1	L	273/281 (97%)	0.05	8 (2%) 51 50	101, 132, 168, 182	0
All	All	3275/3372 (97%)	-0.12	17 (0%) 91 90	56, 96, 145, 182	0

All (17) RSRZ outliers are listed below:

Mol	Chain	Res	Type	RSRZ
1	J	394	LEU	4.2
1	L	316	LEU	4.1
1	L	341	LEU	3.1
1	K	209	THR	3.0
1	L	360	VAL	2.8
1	L	347	LEU	2.7
1	L	251	PHE	2.6
1	K	317	ILE	2.5
1	L	343	ILE	2.3
1	F	394	LEU	2.3
1	K	174	PRO	2.3

Continued on next page...

Continued from previous page...

Mol	Chain	Res	Type	RSRZ
1	L	168	LEU	2.3
1	K	212	PHE	2.2
1	K	164	LEU	2.1
1	D	366	VAL	2.1
1	K	394	LEU	2.1
1	L	287	VAL	2.0

6.2 Non-standard residues in protein, DNA, RNA chains [i](#)

There are no non-standard protein/DNA/RNA residues in this entry.

6.3 Carbohydrates [i](#)

There are no monosaccharides in this entry.

6.4 Ligands [i](#)

In the following table, the Atoms column lists the number of modelled atoms in the group and the number defined in the chemical component dictionary. The B-factors column lists the minimum, median, 95th percentile and maximum values of B factors of atoms in the group. The column labelled 'Q<0.9' lists the number of atoms with occupancy less than 0.9.

Mol	Type	Chain	Res	Atoms	RSCC	RSR	B-factors(Å ²)	Q<0.9
5	GOL	K	1396	6/6	0.90	0.30	86,86,86,86	0
3	SR7	L	1397	34/34	0.92	0.25	86,86,86,86	0
3	SR7	K	1397	34/34	0.92	0.29	86,86,86,86	0
3	SR7	J	1396	34/34	0.93	0.24	86,86,86,86	0
3	SR7	F	1396	34/34	0.94	0.26	86,86,86,86	0
2	CNA	D	1394	44/44	0.94	0.22	86,86,86,86	0
2	CNA	K	1395	44/44	0.94	0.21	86,86,86,86	0
2	CNA	L	1395	44/44	0.94	0.21	86,86,86,86	0
5	GOL	D	1395	6/6	0.94	0.40	86,86,86,86	0
3	SR7	B	1396	34/34	0.94	0.28	86,86,86,86	0
3	SR7	E	1396	34/34	0.95	0.26	86,86,86,86	0
3	SR7	A	1396	34/34	0.95	0.31	86,86,86,86	0
3	SR7	G	1396	34/34	0.95	0.29	86,86,86,86	0
2	CNA	C	1395	44/44	0.95	0.23	86,86,86,86	0
2	CNA	H	1395	44/44	0.96	0.19	86,86,86,86	0
3	SR7	H	1396	34/34	0.96	0.32	86,86,86,86	0
3	SR7	I	1396	34/34	0.96	0.25	86,86,86,86	0

Continued on next page...

Continued from previous page...

Mol	Type	Chain	Res	Atoms	RSCC	RSR	B-factors(\AA^2)	Q<0.9
2	CNA	I	1395	44/44	0.96	0.17	86,86,86,86	0
3	SR7	C	1397	34/34	0.96	0.29	86,86,86,86	0
3	SR7	D	1396	34/34	0.96	0.33	86,86,86,86	0
5	GOL	C	1396	6/6	0.96	0.34	86,86,86,86	0
2	CNA	B	1395	44/44	0.96	0.23	86,86,86,86	0
2	CNA	G	1395	44/44	0.96	0.23	86,86,86,86	0
5	GOL	L	1396	6/6	0.96	0.24	86,86,86,86	0
4	ZN	J	1397	1/1	0.97	0.10	86,86,86,86	0
2	CNA	F	1395	44/44	0.97	0.19	86,86,86,86	0
2	CNA	J	1395	44/44	0.97	0.21	86,86,86,86	0
2	CNA	A	1395	44/44	0.97	0.23	86,86,86,86	0
2	CNA	E	1395	44/44	0.97	0.19	86,86,86,86	0
4	ZN	L	1398	1/1	0.98	0.15	86,86,86,86	0
4	ZN	I	1397	1/1	0.99	0.07	86,86,86,86	0
4	ZN	A	1397	1/1	0.99	0.13	86,86,86,86	0
4	ZN	K	1398	1/1	0.99	0.14	86,86,86,86	0
4	ZN	C	1398	1/1	0.99	0.12	86,86,86,86	0
4	ZN	D	1397	1/1	0.99	0.12	86,86,86,86	0
4	ZN	E	1397	1/1	0.99	0.11	86,86,86,86	0
4	ZN	F	1397	1/1	0.99	0.07	86,86,86,86	0
4	ZN	H	1397	1/1	0.99	0.07	86,86,86,86	0
4	ZN	G	1397	1/1	1.00	0.14	86,86,86,86	0
4	ZN	B	1397	1/1	1.00	0.16	86,86,86,86	0

The following is a graphical depiction of the model fit to experimental electron density of all instances of the Ligand of Interest. In addition, ligands with molecular weight > 250 and outliers as shown on the geometry validation Tables will also be included. Each fit is shown from different orientation to approximate a three-dimensional view.

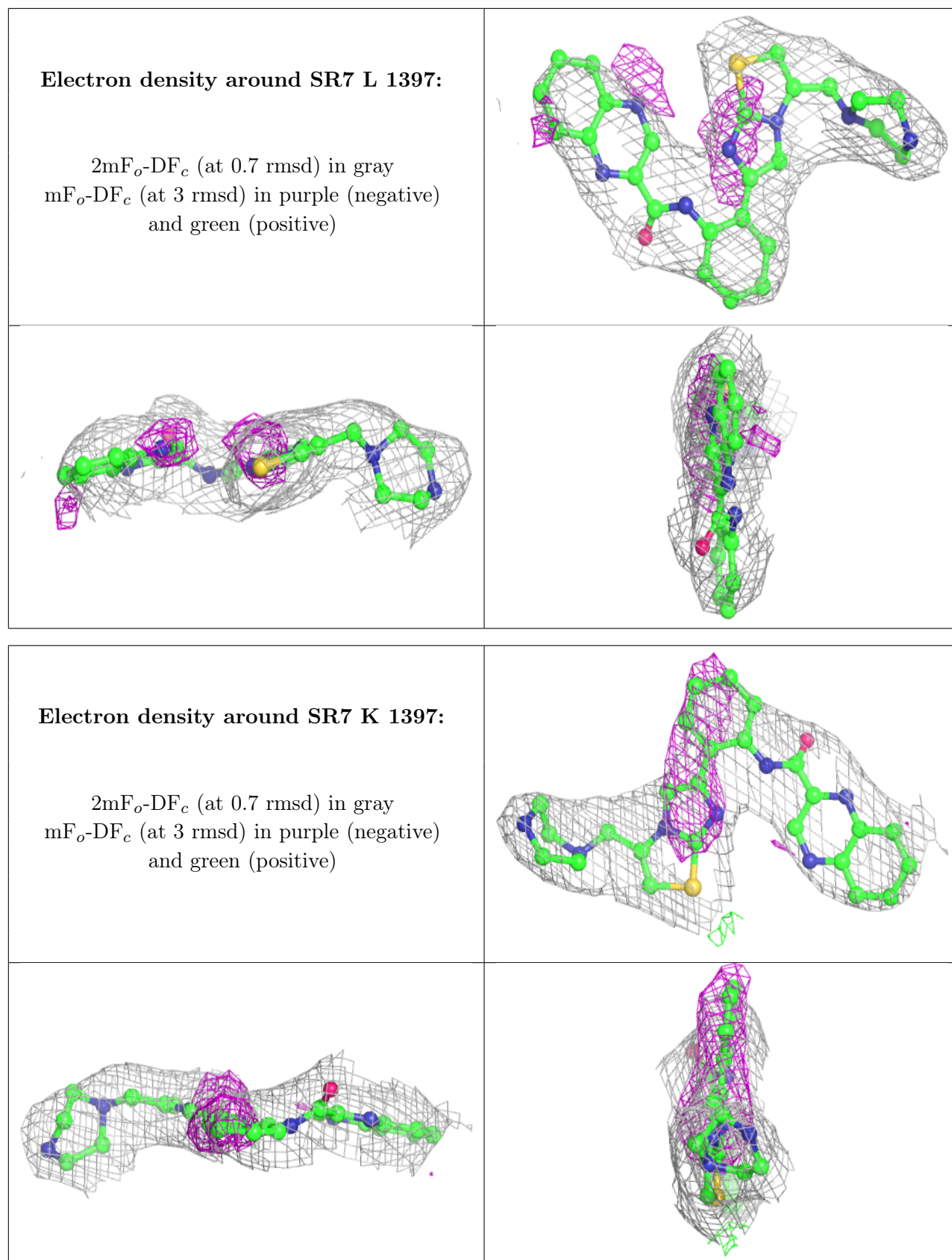

Electron density around SR7 J 1396:

$2mF_o-DF_c$ (at 0.7 rmsd) in gray
 mF_o-DF_c (at 3 rmsd) in purple (negative)
and green (positive)

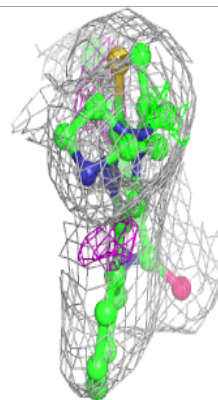
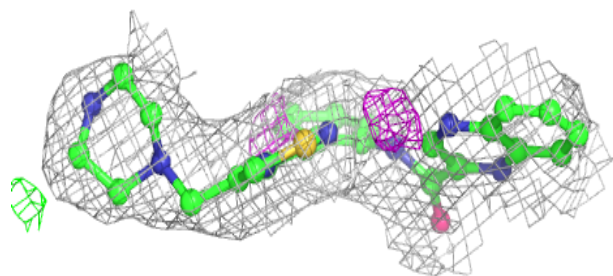
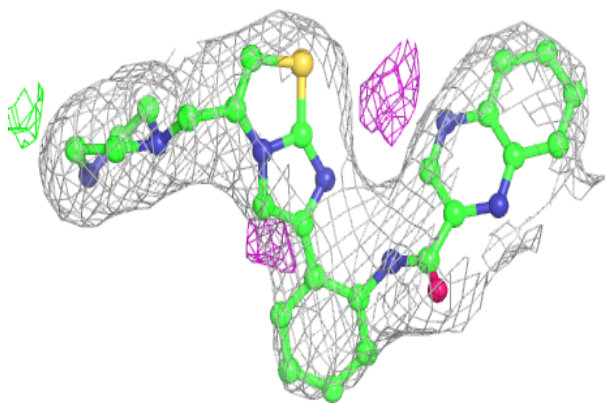
**Electron density around SR7 F 1396:**

$2mF_o-DF_c$ (at 0.7 rmsd) in gray
 mF_o-DF_c (at 3 rmsd) in purple (negative)
and green (positive)

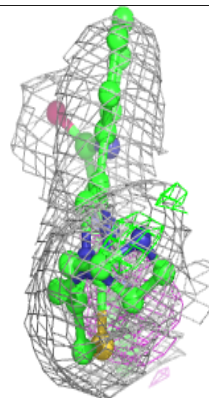
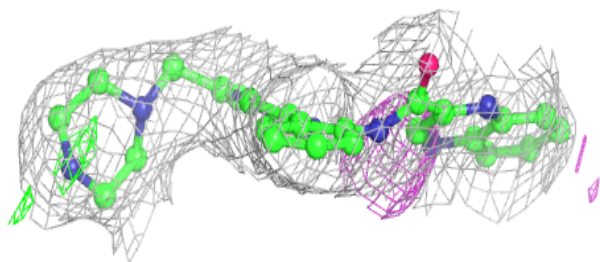
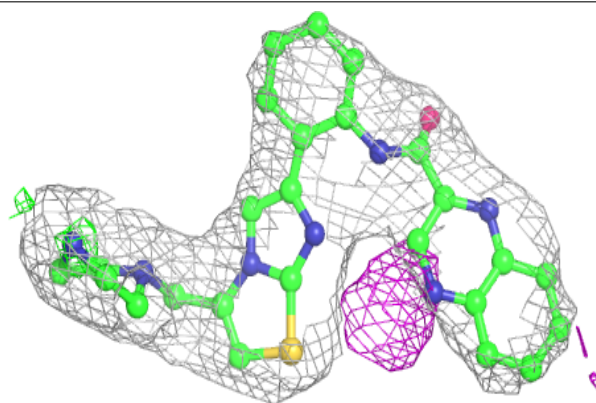

Electron density around CNA D 1394:

$2mF_o-DF_c$ (at 0.7 rmsd) in gray
 mF_o-DF_c (at 3 rmsd) in purple (negative)
and green (positive)

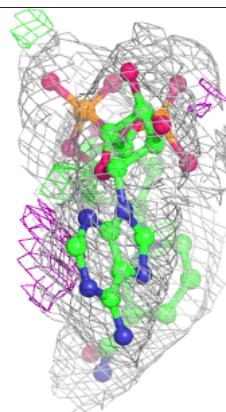
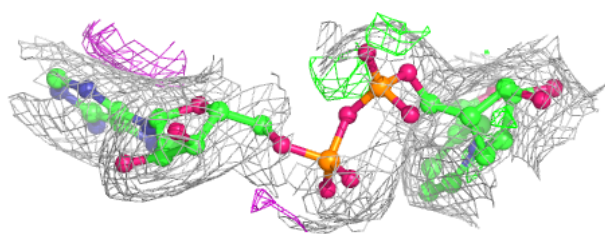
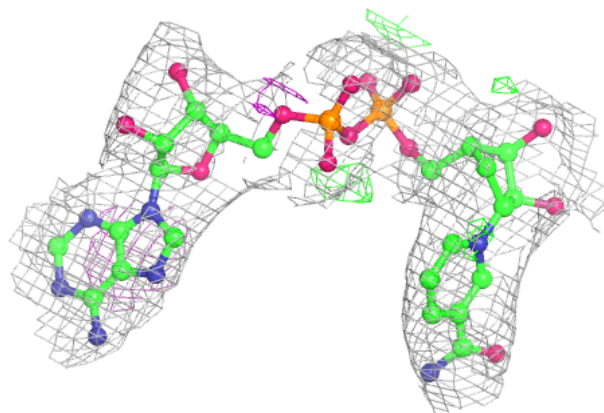
**Electron density around CNA K 1395:**

$2mF_o-DF_c$ (at 0.7 rmsd) in gray
 mF_o-DF_c (at 3 rmsd) in purple (negative)
and green (positive)

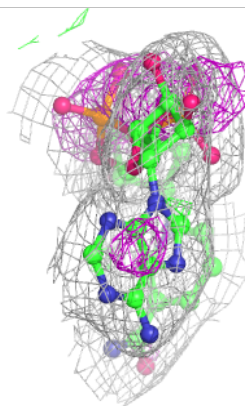
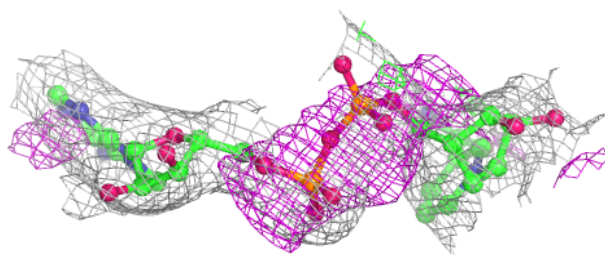
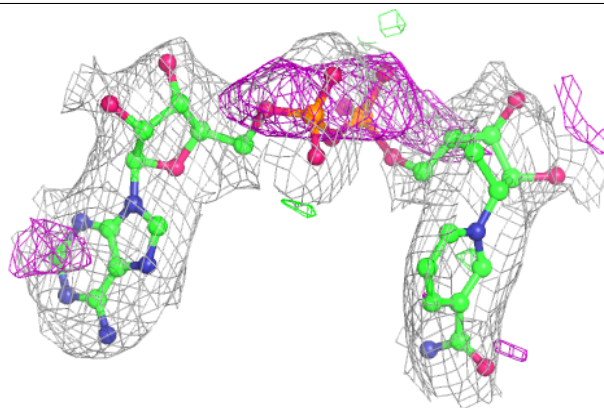

Electron density around CNA L 1395:

$2mF_o-DF_c$ (at 0.7 rmsd) in gray
 mF_o-DF_c (at 3 rmsd) in purple (negative)
and green (positive)

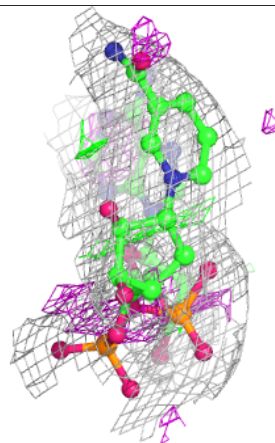
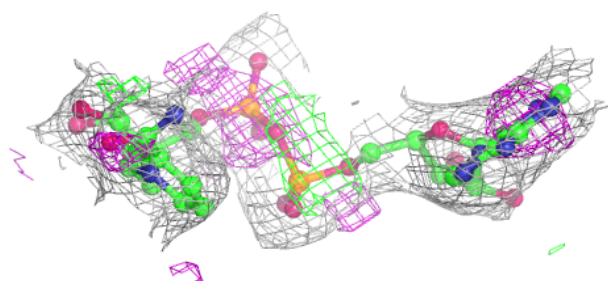
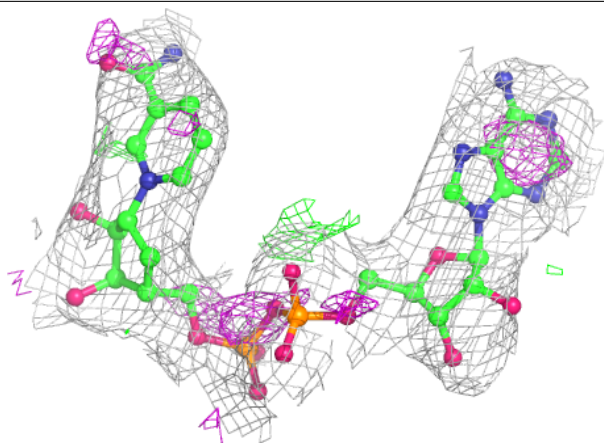
**Electron density around SR7 B 1396:**

$2mF_o-DF_c$ (at 0.7 rmsd) in gray
 mF_o-DF_c (at 3 rmsd) in purple (negative)
and green (positive)

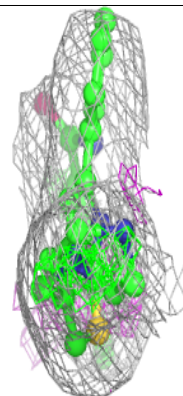
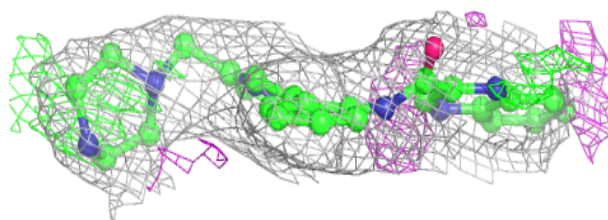
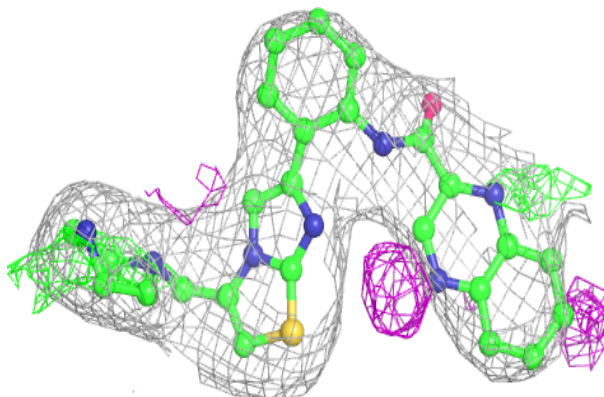

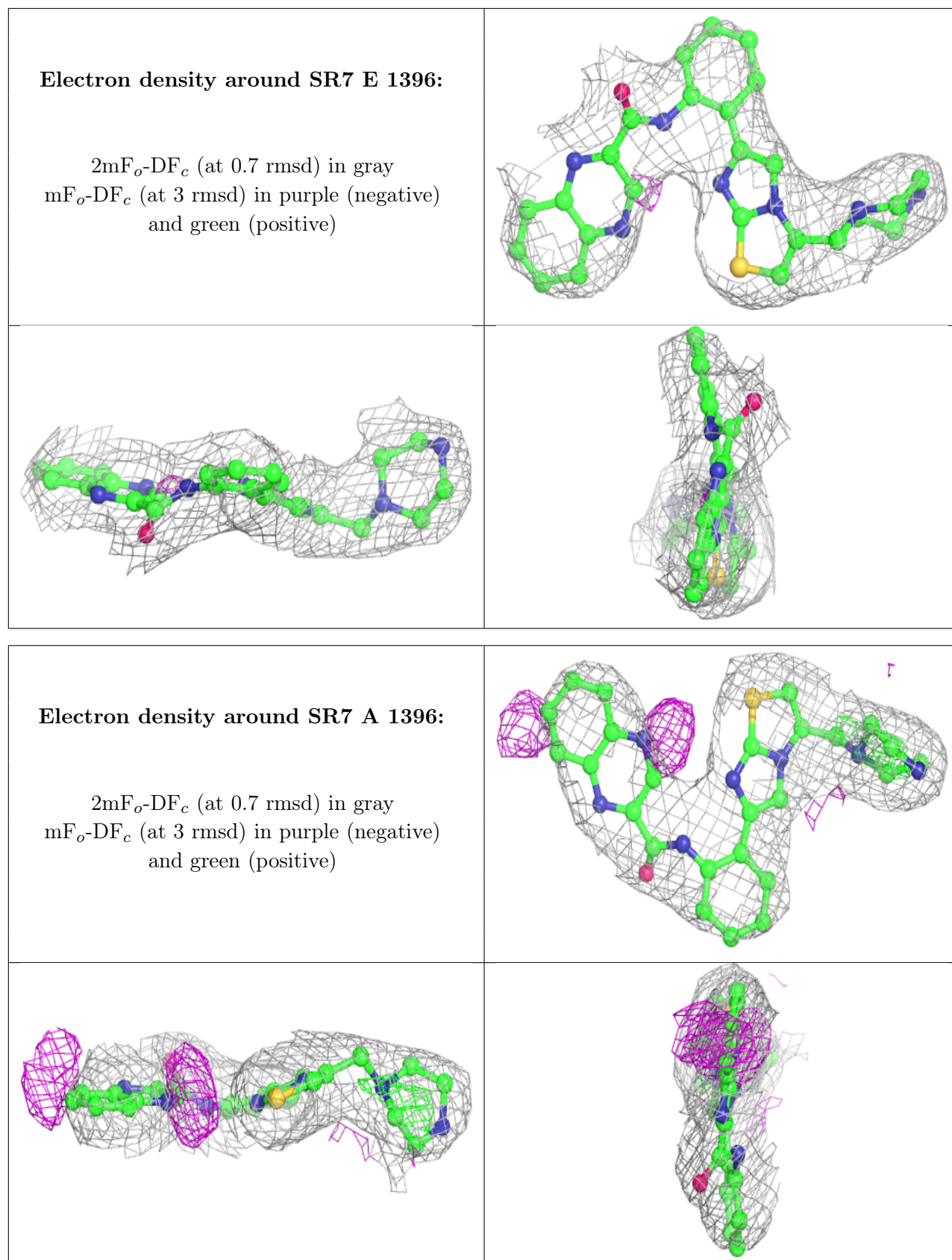

Electron density around SR7 G 1396:

$2mF_o-DF_c$ (at 0.7 rmsd) in gray
 mF_o-DF_c (at 3 rmsd) in purple (negative)
and green (positive)

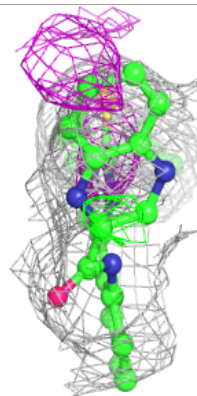
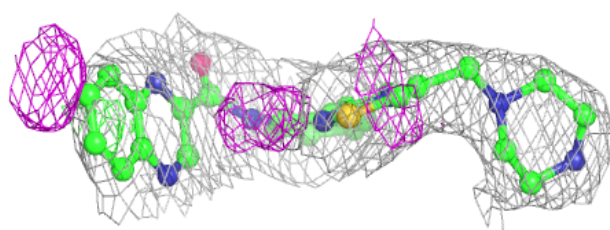
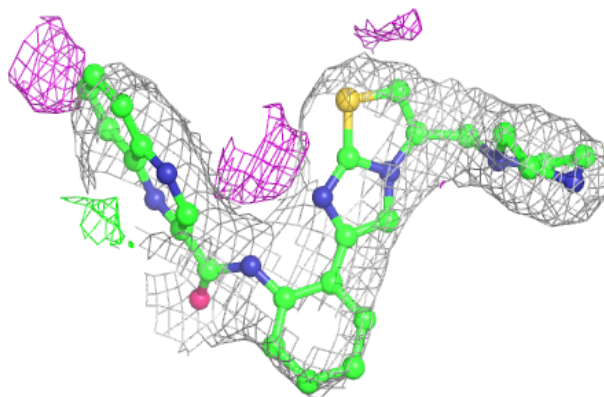
**Electron density around CNA C 1395:**

$2mF_o-DF_c$ (at 0.7 rmsd) in gray
 mF_o-DF_c (at 3 rmsd) in purple (negative)
and green (positive)

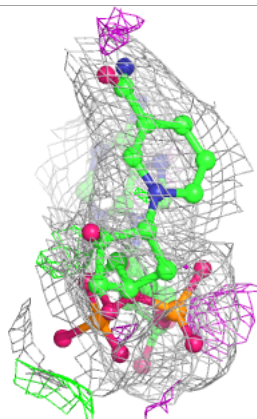
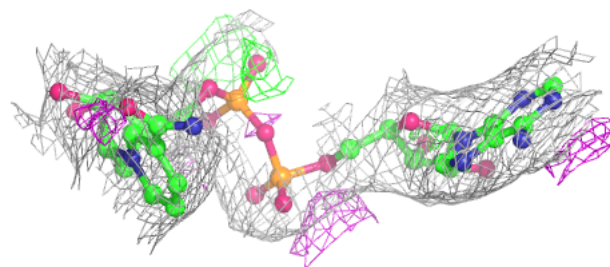
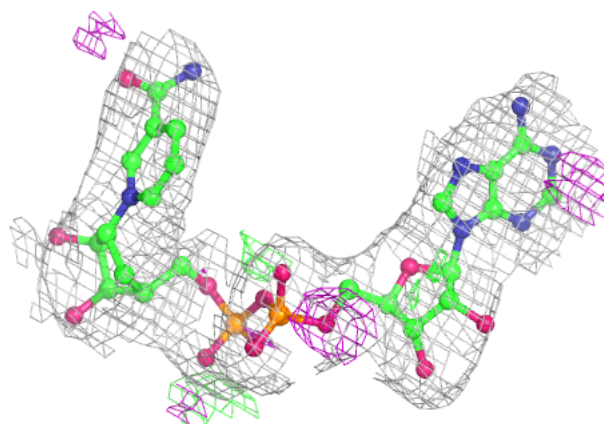

Electron density around CNA H 1395:

$2mF_o-DF_c$ (at 0.7 rmsd) in gray
 mF_o-DF_c (at 3 rmsd) in purple (negative)
and green (positive)

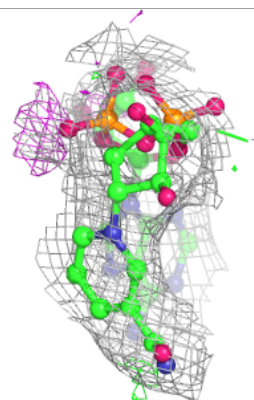
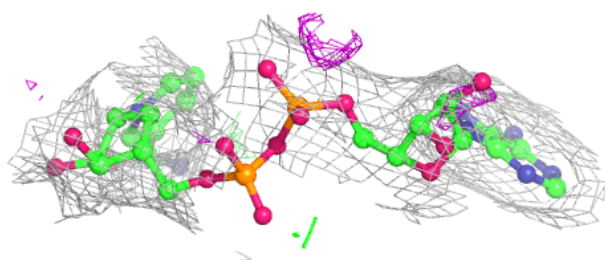
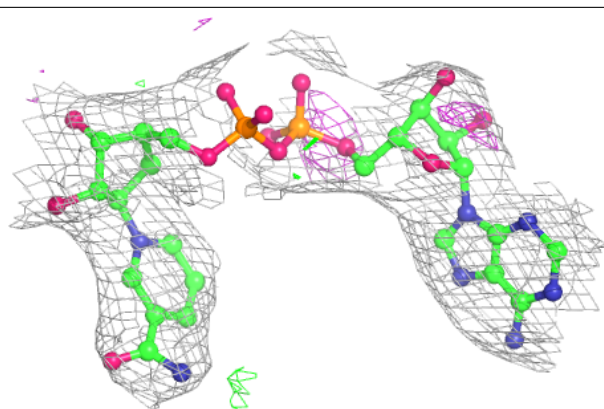
**Electron density around SR7 H 1396:**

$2mF_o-DF_c$ (at 0.7 rmsd) in gray
 mF_o-DF_c (at 3 rmsd) in purple (negative)
and green (positive)

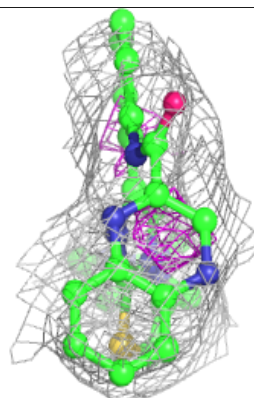
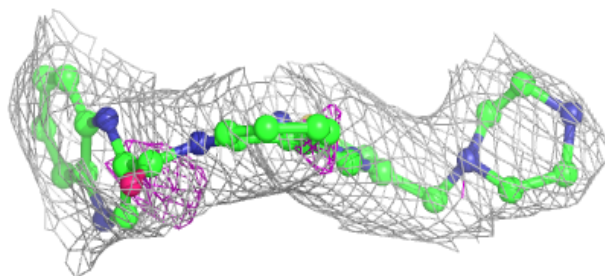
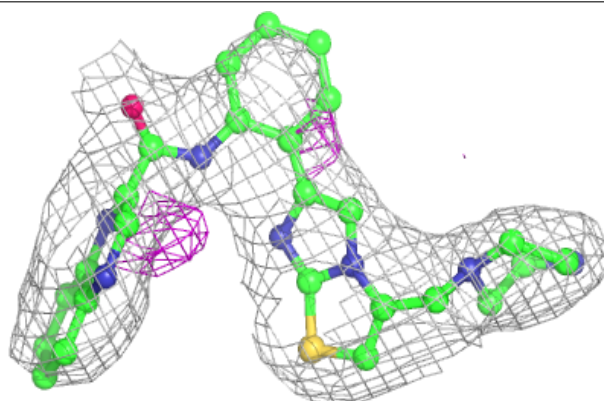

Electron density around SR7 I 1396:

$2mF_o-DF_c$ (at 0.7 rmsd) in gray
 mF_o-DF_c (at 3 rmsd) in purple (negative)
and green (positive)

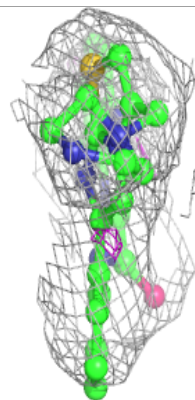
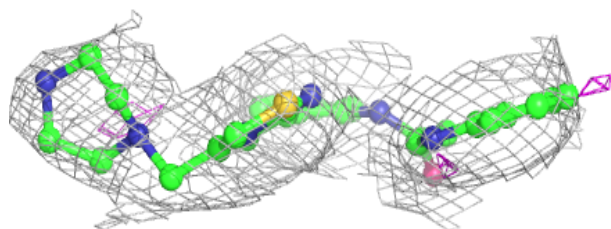
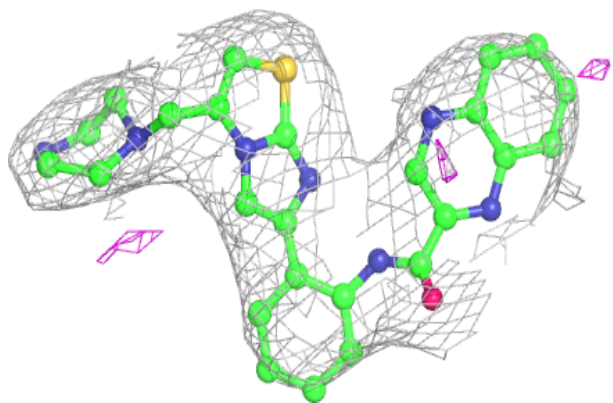
**Electron density around CNA I 1395:**

$2mF_o-DF_c$ (at 0.7 rmsd) in gray
 mF_o-DF_c (at 3 rmsd) in purple (negative)
and green (positive)

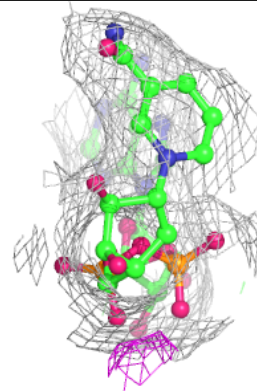
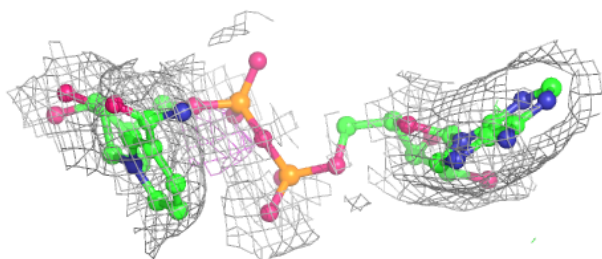
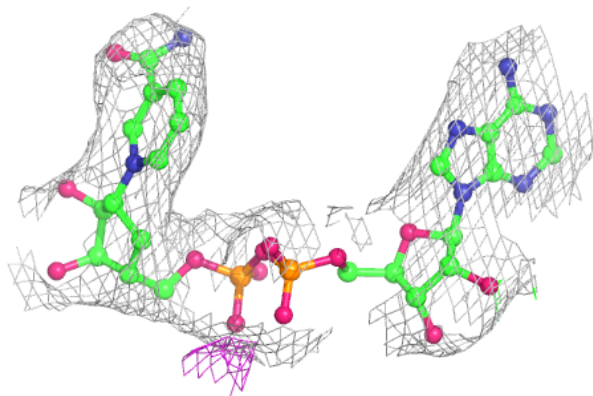

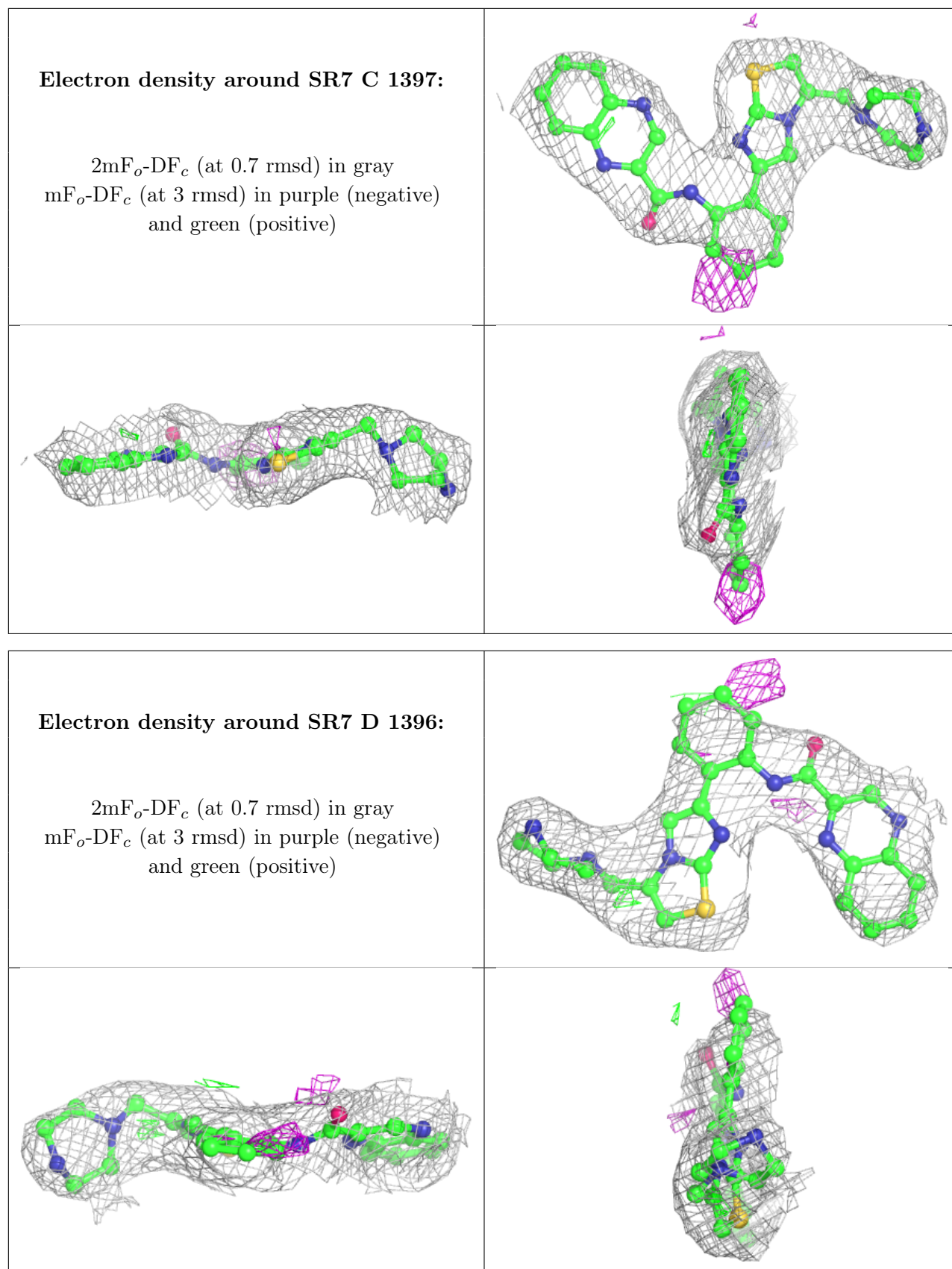

Electron density around CNA B 1395:

$2mF_o-DF_c$ (at 0.7 rmsd) in gray
 mF_o-DF_c (at 3 rmsd) in purple (negative)
and green (positive)

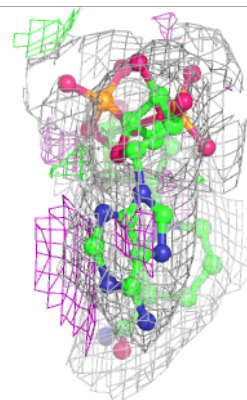
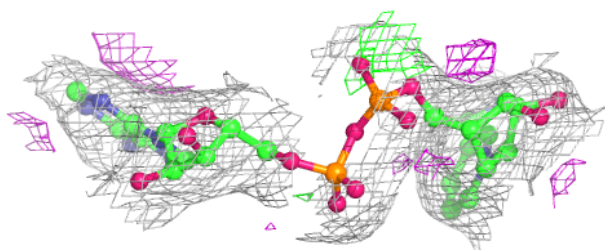
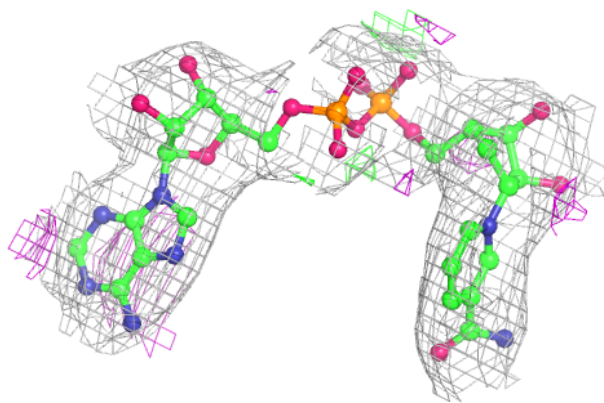
**Electron density around CNA G 1395:**

$2mF_o-DF_c$ (at 0.7 rmsd) in gray
 mF_o-DF_c (at 3 rmsd) in purple (negative)
and green (positive)

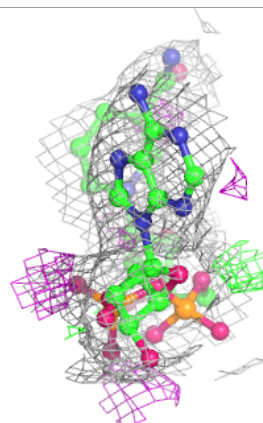
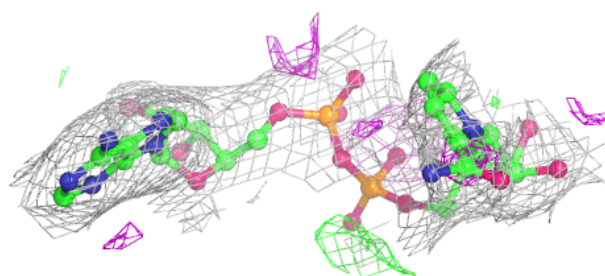
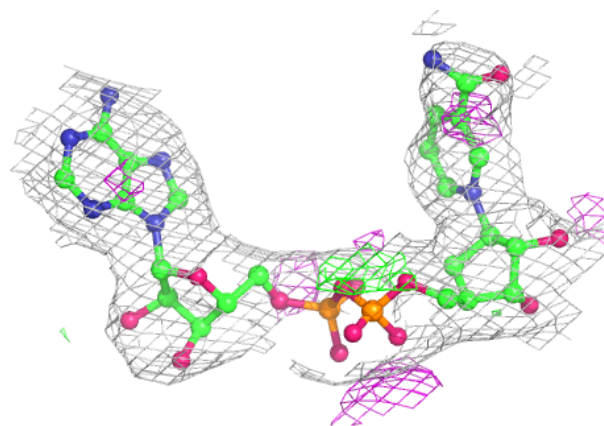

Electron density around CNA F 1395:

$2mF_o-DF_c$ (at 0.7 rmsd) in gray
 mF_o-DF_c (at 3 rmsd) in purple (negative)
and green (positive)

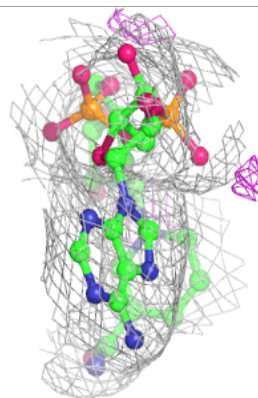
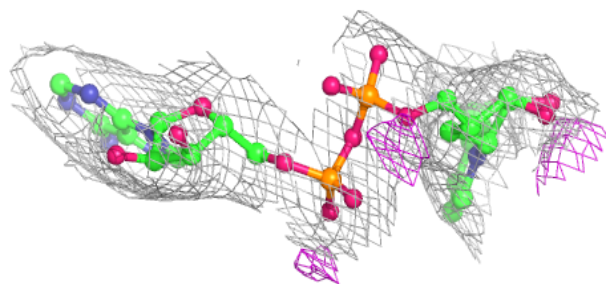
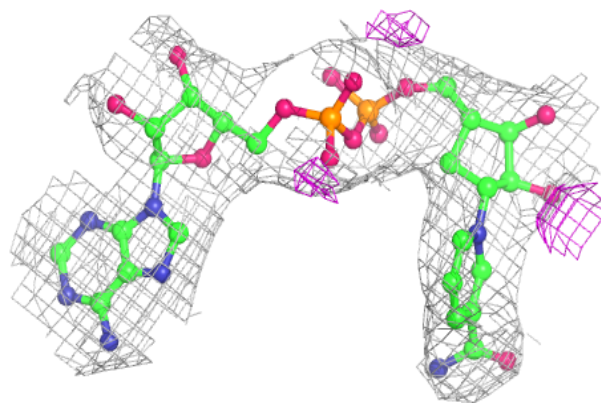
**Electron density around CNA J 1395:**

$2mF_o-DF_c$ (at 0.7 rmsd) in gray
 mF_o-DF_c (at 3 rmsd) in purple (negative)
and green (positive)

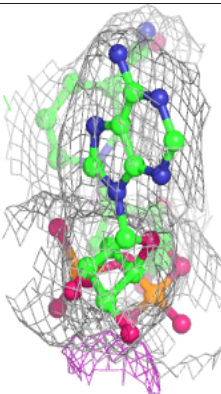
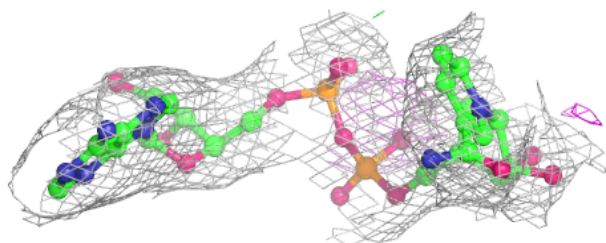
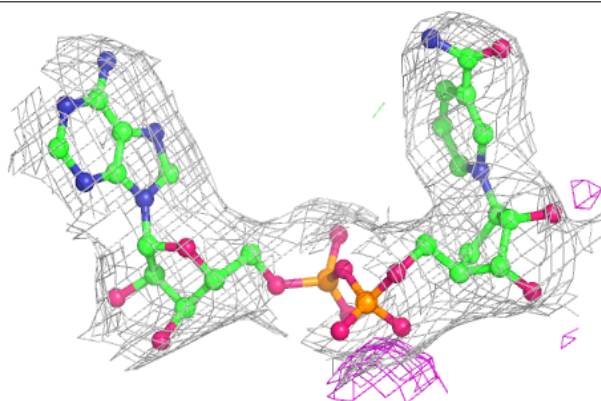

Electron density around CNA A 1395:

$2mF_o-DF_c$ (at 0.7 rmsd) in gray
 mF_o-DF_c (at 3 rmsd) in purple (negative)
and green (positive)

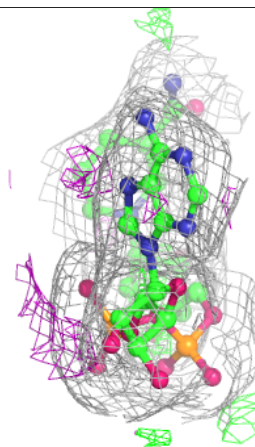
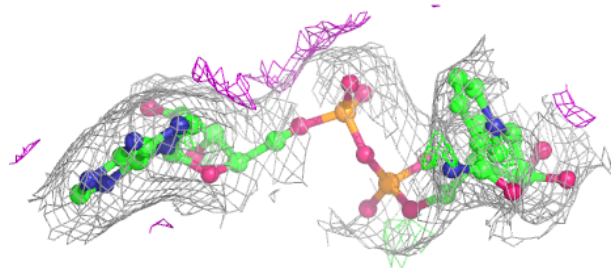
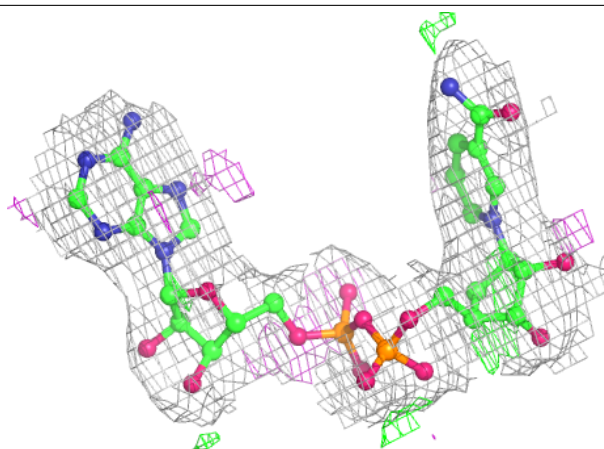
**Electron density around CNA E 1395:**

$2mF_o-DF_c$ (at 0.7 rmsd) in gray
 mF_o-DF_c (at 3 rmsd) in purple (negative)
and green (positive)

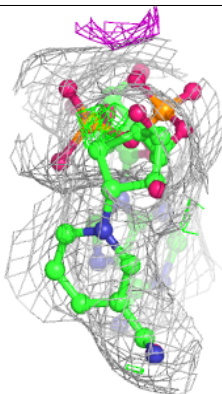
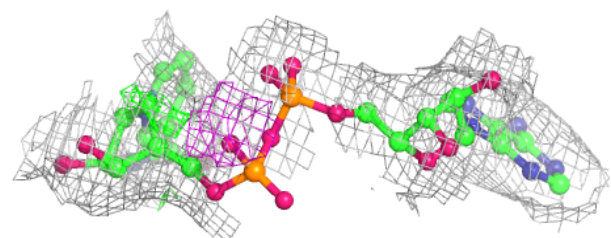
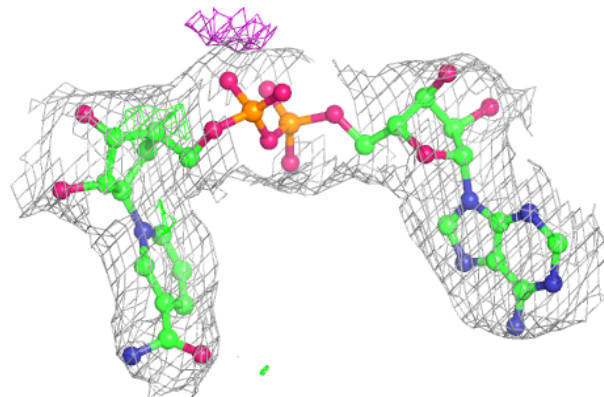

6.5 Other polymers [i](#)

There are no such residues in this entry.